



NetSure™ 8200 Series -48 VDC Power System

User Manual

Specification Number: 582140000

Model Number: 8200NLDB, 8200NLEB, 8200NL-B

The information contained in this document is subject to change without notice and may not be suitable for all applications. While every precaution has been taken to ensure the accuracy and completeness of this document, Vertiv assumes no responsibility and disclaims all liability for damages resulting from use of this information or for any errors or omissions. Refer to other local practices or building codes as applicable for the correct methods, tools, and materials to be used in performing procedures not specifically described in this document.

The products covered by this instruction manual are manufactured and/or sold by Vertiv. This document is the property of Vertiv and contains confidential and proprietary information owned by Vertiv. Any copying, use or disclosure of it without the written permission of Vertiv is strictly prohibited.

Names of companies and products are trademarks or registered trademarks of the respective companies. Any questions regarding usage of trademark names should be directed to the original manufacturer.

Technical Support Site

If you encounter any installation or operational issues with your product, check the pertinent section of this manual to see if the issue can be resolved by following outlined procedures.

Visit <https://www.vertiv.com/en-us/support/> for additional assistance.

TABLE OF CONTENTS

Admonishments Used in this Document	iv
Important Safety Instructions	v
Safety Admonishments Definitions.....	v
Safety and Regulatory Statements.....	v
Déclarations de Sécurité et de Réglementation.....	v
1 Customer Documentation Package	1
2 System Description	2
2.1 Description.....	2
2.2 System Overview Illustrations.....	4
3 System Operating Procedures	13
3.1 NCU Controller Operating Procedures.....	13
3.1.1 General.....	13
3.1.2 NCU Numbering Scheme.....	13
3.1.3 Inventory Screen.....	14
3.1.4 DC View Screen.....	14
3.1.5 Advanced Settings Screen.....	16
3.2 Front Panel Touch Screen.....	17
3.3 NCU Battery Charge Current Limit Feature.....	18
3.4 Local Controls and Indicators.....	18
3.4.1 Controller.....	18
3.5 External Alarms.....	20
3.6 Starting and Stopping System Operation.....	20
3.7 Restarting Procedures when Rectifier is Automatically or Manually Inhibited, Shut Down, or Locked Out.....	20
4 System Maintenance	20
4.1 Important Safety Instructions.....	20
4.2 System Maintenance Procedures.....	20
4.3 Adding a Rectifier.....	21
5 System Troubleshooting and Repair	21
5.1 Important Safety Instructions.....	21
5.2 Contact Information.....	21
5.3 Controller.....	21
5.4 SM-DUE.....	22
5.5 Troubleshooting Information.....	22
5.6 Replacement Information.....	24
5.7 Replacement Procedures.....	24
5.7.1 Important Safety Instructions.....	24
5.7.2 Rectifier Replacement.....	24
5.7.3 Replacing the NCU Controller.....	26
5.7.4 Circuit Card Replacement Procedures.....	26

Admonishments Used in this Document



DANGER! Warns of a hazard the reader **will** be exposed to that will **likely** result in death or serious injury if not avoided. (ANSI, OSHA)



WARNING! Warns of a potential hazard the reader **may** be exposed to that **could** result in death or serious injury if not avoided. This admonition is not used for situations that pose a risk only to equipment, software, data, or service. (ANSI)



CAUTION! Warns of a potential hazard the reader **may** be exposed to that **could** result in minor or moderate injury if not avoided. (ANSI, OSHA) This admonition is not used for situations that pose a risk only to equipment, data, or service, even if such use appears to be permitted in some of the applicable standards. (OSHA)



ALERT! Alerts the reader to an action that **must be avoided** in order to protect equipment, software, data, or service. (ISO)



ALERT! Alerts the reader to an action that **must be performed** in order to prevent equipment damage, software corruption, data loss, or service interruption. (ISO)



FIRE SAFETY! Informs the reader of fire safety information, reminders, precautions, or policies, or of the locations of fire-fighting and fire-safety equipment. (ISO)



SAFETY! Informs the reader of general safety information, reminders, precautions, or policies not related to a particular source of hazard or to fire safety. (ISO, ANSI, OSHA)

Important Safety Instructions

Safety Admonishments Definitions

Definitions of the safety admonishments used in this document are listed under “Admonishments Used in this Document” on page iv.

Safety and Regulatory Statements

Refer to Section 4154 (provided with your customer documentation) for Safety and Regulatory Statements.

Déclarations de Sécurité et de Réglementation

Reportez-vous à la Section 4154 (fourni avec les documents de votre client) pour les déclarations de sécurité et de réglementation.

This page intentionally left blank.

1 Customer Documentation Package



NOTE! These instructions are for the NetSure™ 8200 Series -48 VDC Power System, Model 8200NLDB (208V Input Power/Distribution and Power Only Bays), 8200NLEB (480V Input Power/Distribution and Power Only Bays), and 8200NL-B (Distribution Only Bay); Spec. No. 582140000. **This power system is equipped with the NCU controller.**

If you have a NetSure™ 802 Series -48 VDC Power System, Model 802NLDB (208V Input Power/Distribution and Power Only Bays), 802NLEB (480V Input Power/Distribution and Power Only Bays), and 802NL-B (Distribution Only Bay); Spec. No. 582140000, refer to document “Section 5877” provided with your system. **This power system is equipped with the MCA (Meter, Control, Alarm Panel) and LMS (Lorain Monitoring System).**

This document (UM582140000) provides *User Instructions* for the Vertiv™ NetSure™ 8200 Series -48 VDC Power System, Model 8200NLDB (208V Input Power/Distribution and Power Only Bays), 8200NLEB (480V Input Power/Distribution and Power Only Bays), and 8200NL-B (Distribution Only Bay); Spec. No. 582140000.

For factory settings of all configurable parameters, refer to the configuration drawing (C-drawing) supplied with your system.

The complete Customer Documentation Package consists of...

Power System Installation Manual

- Power System Installation Instructions: IM582140000

Controller User Manual

- NCU Controller User Instructions: UM1M830BNA

USB Drive with All Customer Documentation

™Vertiv NetSure™ 8200 Series

- Power System Installation Instructions: IM582140000
- Power System User Instructions: UM582140000
- NCU Controller User Instructions: UM1M830BNA
- Power System “System Application Guide”: SAG582140000
- Contact Information Page: Section 4154
- Engineering Drawings
 - SD582140000
 - T582140000
- Also provided on the USB drive is a controller configuration drawing and the controller configuration files loaded into the controller as shipped.

Vertiv NetSure™ 802 Series

- Power System Installation Instructions: Section 5876
- Power System User Instructions: Section 5877
- Power System Installation Guide: Section 5957
(condensed version of Section 5876 Installation Instructions)

2 System Description

Refer to SAG582140000 (System Application Guide) for additional information.

2.1 Description

-48 VDC @ up to 16,000 Amperes Power System

The Vertiv™ NetSure™ 8200NLDB (208V Input Power/Distribution and Power Only Bays), 8200NLEB (480V Input Power/Distribution and Power Only Bays), and 8200NL-B (Distribution Only Bay) DC Power System is an integrated power system containing rectifiers, intelligent control, metering, monitoring, and distribution.

This power system is designed to power a load while charging a positive grounded battery. The power system is capable of operating in a batteryless installation or off battery for maintenance purposes. The power system is designed for operation with the positive output grounded.

This power system can consist of the following components. The system must consist of one (1) primary power/distribution bay or primary power only bay and may consist of up to seven (7) additional bays. These additional bays may be a combination of secondary power/distribution bays, secondary power only bays, and/or distribution only bays (maximum of 4 distribution only bays per system). The system can be expanded right or left.

Power/Distribution Bays and Power Only Bays

Each power/distribution bay and power only bay can be equipped with up to ten (10) rectifiers. The power/distribution bay and power only bay can be ordered factory configured for various AC input options. The power/distribution bay also provides distribution. Distribution is divided into two buses which accept a choice of fuse and circuit breaker types and sizes.

Each power/distribution bay and power only bay contains a monitor and control shelf. The monitor and control shelf contains an NCU controller (main bay) or NCU controller interface (secondary bays). An SM-DUE module is mounted in each secondary bay's control shelf. Refer to "SM-DUE" on page 3. An indicator is visible from the outside of the bay (at the top) which illuminates if an alarm condition occurs.

The primary power/distribution bay or primary power only bay contains a front panel touch screen connected to the NCU controller. The primary bay also includes an NCU interface board (IB2) which provides digital inputs, temperature inputs, and relay outputs for internal and external monitoring and alarms. An NCU extended interface board (EIB) is also provided for additional inputs/outputs connections. Also furnished is the IB4 board which provides a second Ethernet port. The Ethernet port located on the NCU controller's front panel is used to connect the front panel touch screen directly to the NCU. The Ethernet port located on the IB4 board can be used to connect the NCU to your Local Area Network (LAN) for remote access.

Distribution Only Bays

Each distribution only bay provides four (4) distribution buses. Each distribution bus accepts a choice of 218-type circuit breakers and TPL-type fuses. A distribution only bay may also be equipped with an optional distribution panel which accepts a choice of TPS/TLS-type fuseholders or bullet nose-type circuit breakers. An indicator is visible from the outside of the distribution only bay (at the top) which illuminates if a fuse or circuit breaker in the bay opens.

Rectifiers

The system contains rectifiers; which provide load power, battery float current, and battery recharge current during normal operating conditions.

NCU Controller

The NCU controller provides power system control, rectifier control (including a charge control function), metering functions, monitoring functions, and local/remote alarm functions. The controller also supports rectifier temperature compensation if the system is equipped with a temperature probe(s). Temperature probe(s) may also be designated to monitor ambient temperature and/or battery temperature. The controller also provides data acquisition, system alarm management, and advanced battery and energy

management. The controller contains a color TFT display and keypad for local access. The controller provides an Ethernet port and comes with comprehensive webpages for remote access. The controller has SNMP v3 capability for remote system management. The controller supports software upgrade via its USB port. Refer to the NCU controller instructions (UM1M830BNA) for more information.



NOTE! *In this system, the NCU Ethernet port is connected to a front panel touch screen for local access to the NCU webpages. An IB4 (second Ethernet port board) is also furnished which provides a connection point for a remote monitoring Ethernet connection.*

SM-DUE

The SM-DUE is used to input external monitoring information to the NCU controller. The SM-DUE provides the following monitoring inputs:

- Ten (10) input blocks with each providing the following monitoring inputs:
 - One (1) Load Bus Voltage (0 VDC to 60 VDC) per input block
 - One (1) Load Fuse Alarm (Bus- base of 0 VDC, >10 VDC alarm, <10 VDC normal) per input block
 - One (1) Programmable Analog Input, can be set to accept one (1) of the following inputs per input block:
 - 10 mV DC to 50 mV DC Load Shunt (only load shunts are supported at this time)
 - General-Purpose Current Transducer
 - General-Purpose Voltage Transducer
 - 1 uA/K Temperature Sensor

The SM-DUE also contains a +5 VDC power supply output for connection to external Hall devices.

The SM-DUE connects into the NCU CAN bus. Up to eight (8) SM-DUE units can be connected to an NCU.

Applications

The Vertiv™ NetSure™ 8200NLDB and 8200NLEB is capable of interfacing with Vortex® Power Systems (VPS).

The Vertiv™ NetSure™ 8200NLDB and 8200NLEB is capable of interfacing with legacy power systems.

2.2 System Overview Illustrations

Figure 2.1 Power/Distribution Bay

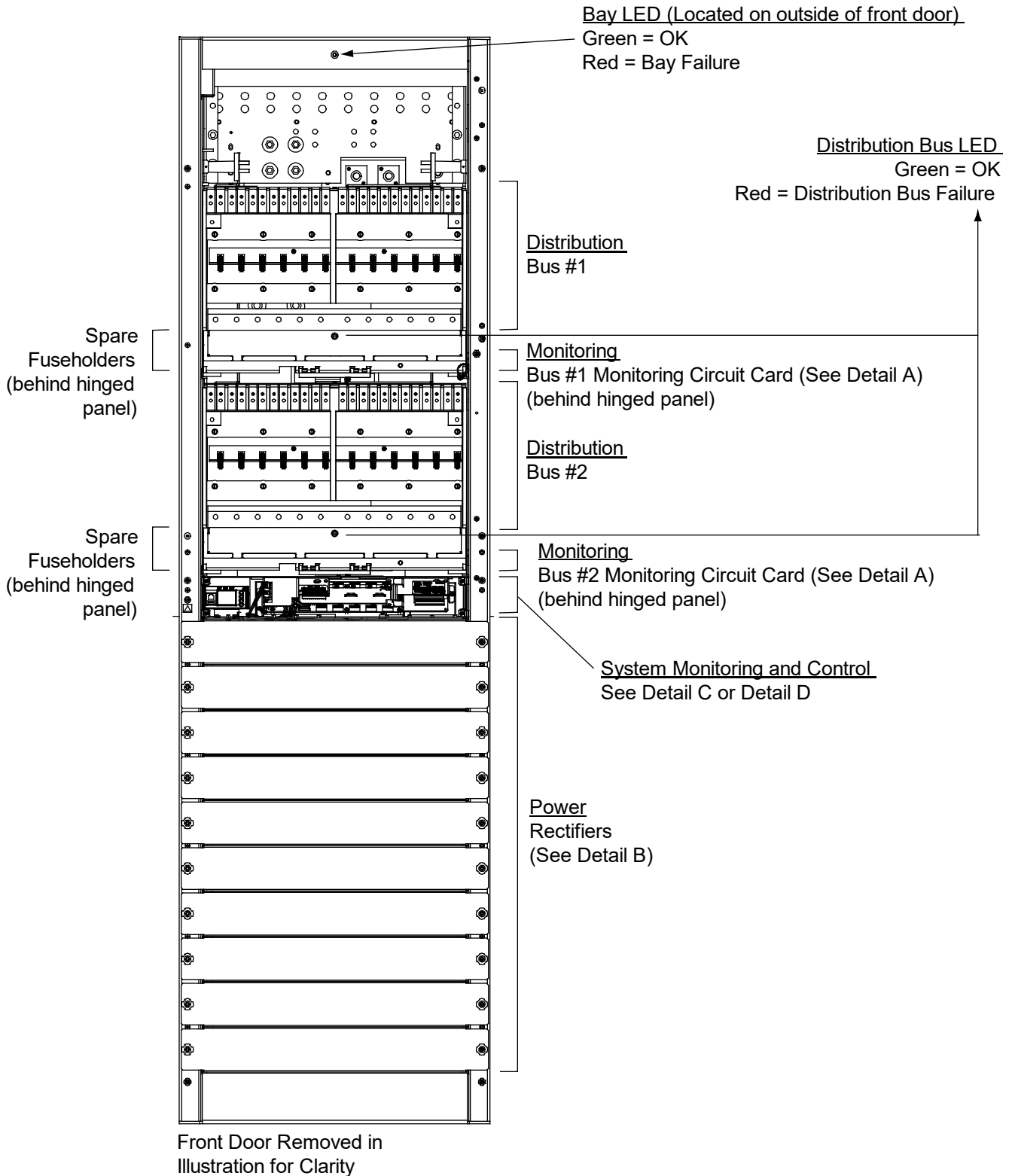

Figure 2.2 Power Only Bay

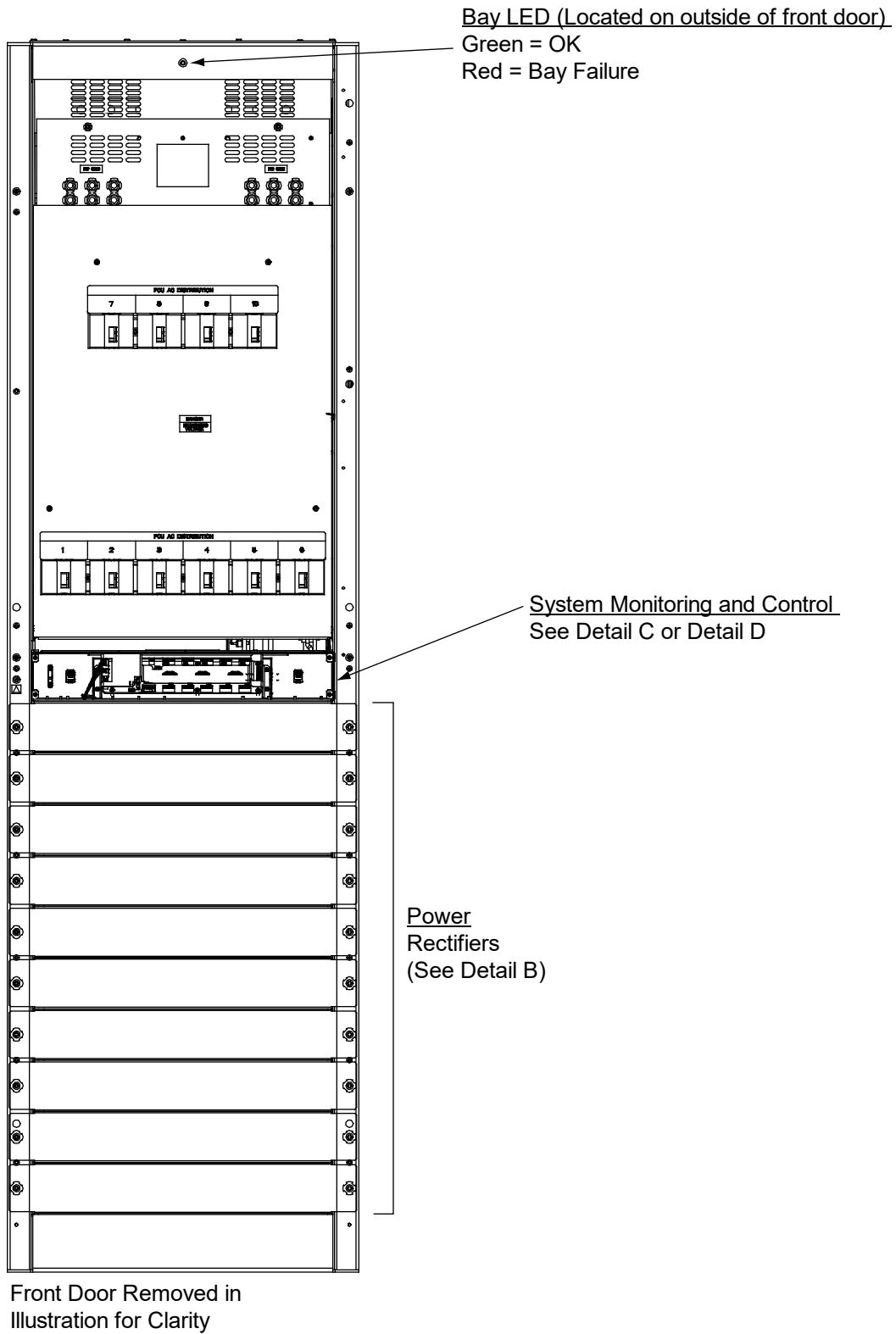

Figure 2.3 Distribution Only Bay (List 116)

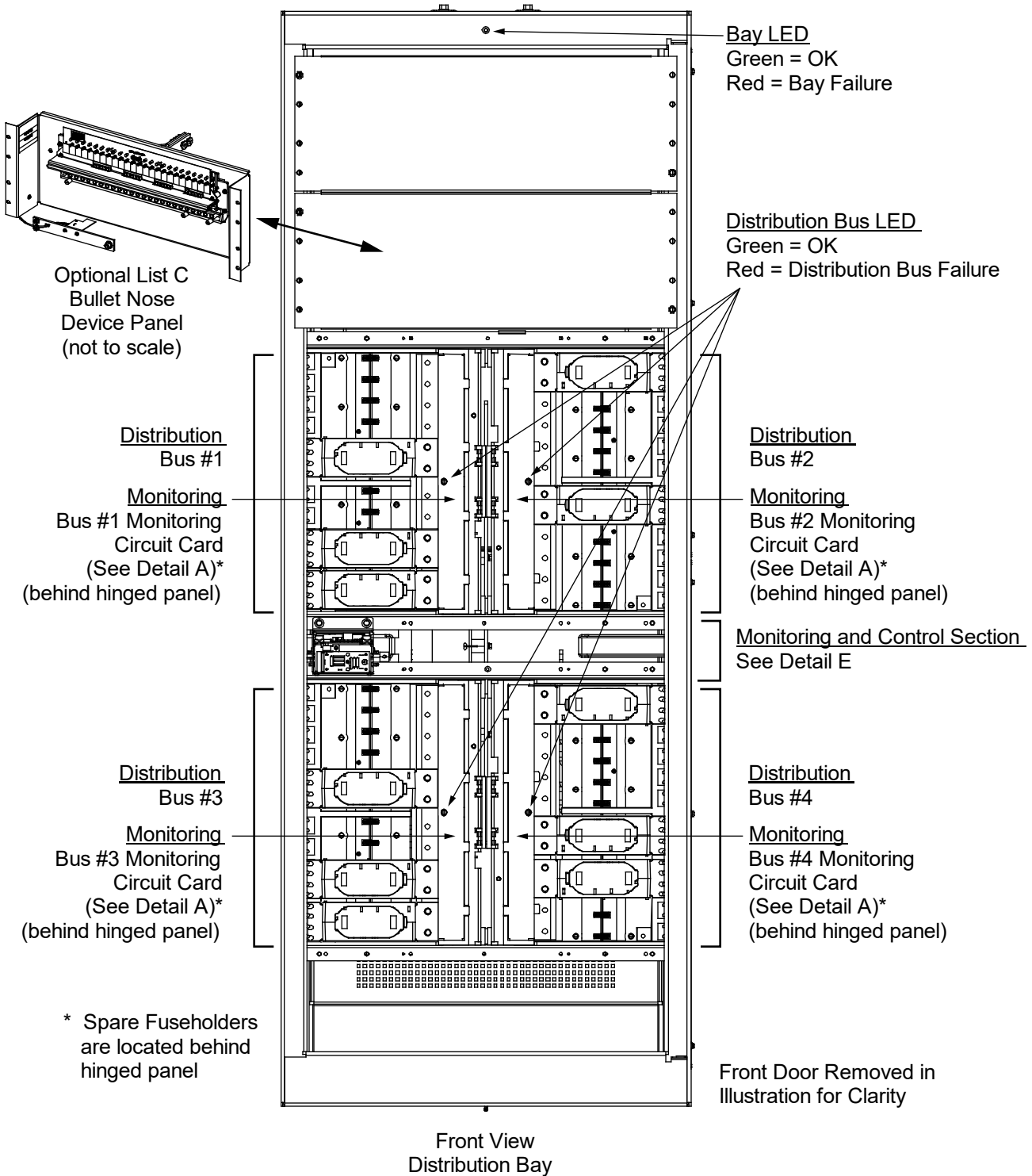

Figure 2.4 Distribution Only Bay (List 117, 118, 122)

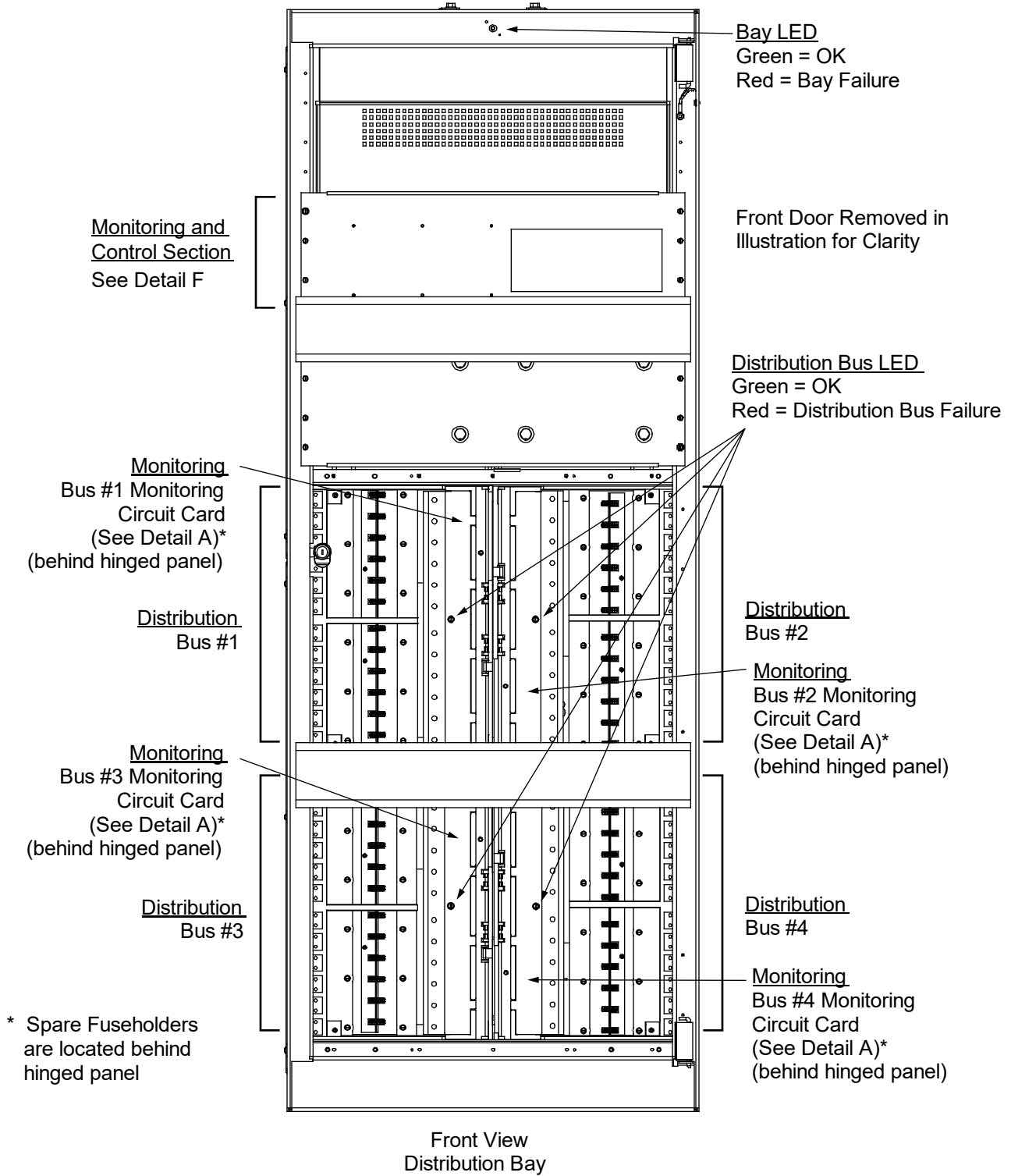
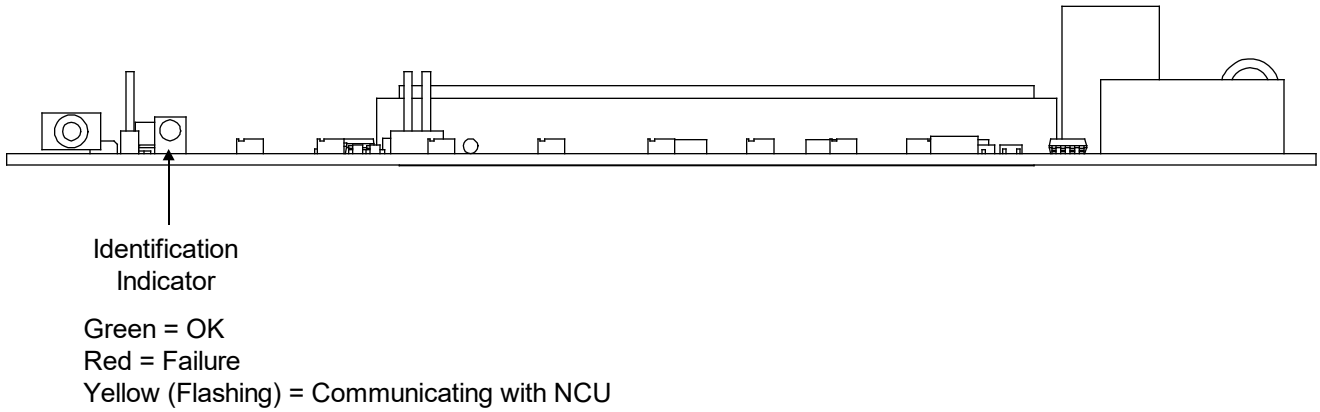

Figure 2.5 Detail A - Distribution Bus Monitoring Circuit Card



DISTRIBUTION BUS MONITORING CIRCUIT CARD

Figure 2.6 Detail B - 208V and 480V Rectifier

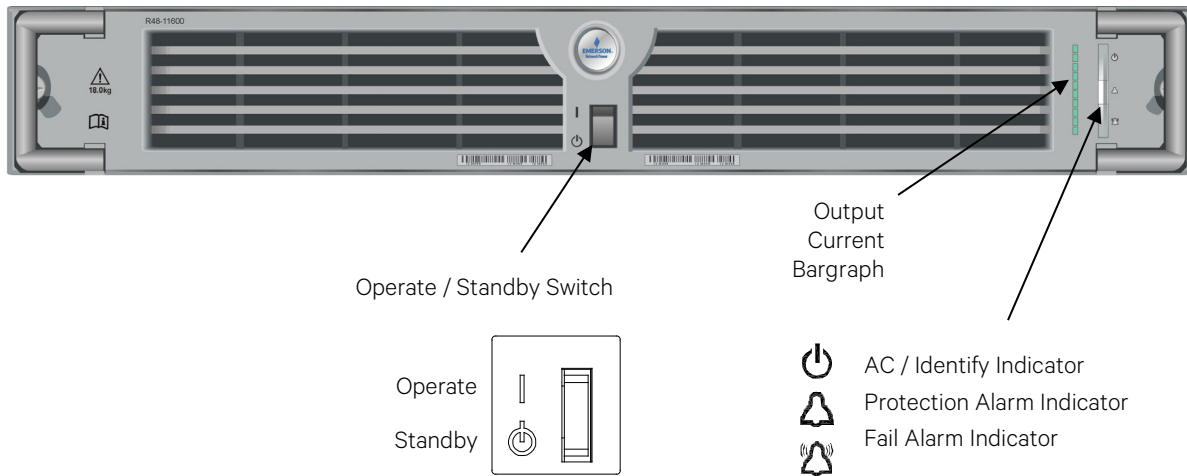

Figure 2.7 Detail C – Primary Power/Distribution Bay or Primary Power Only Bay System Monitoring and Control Section

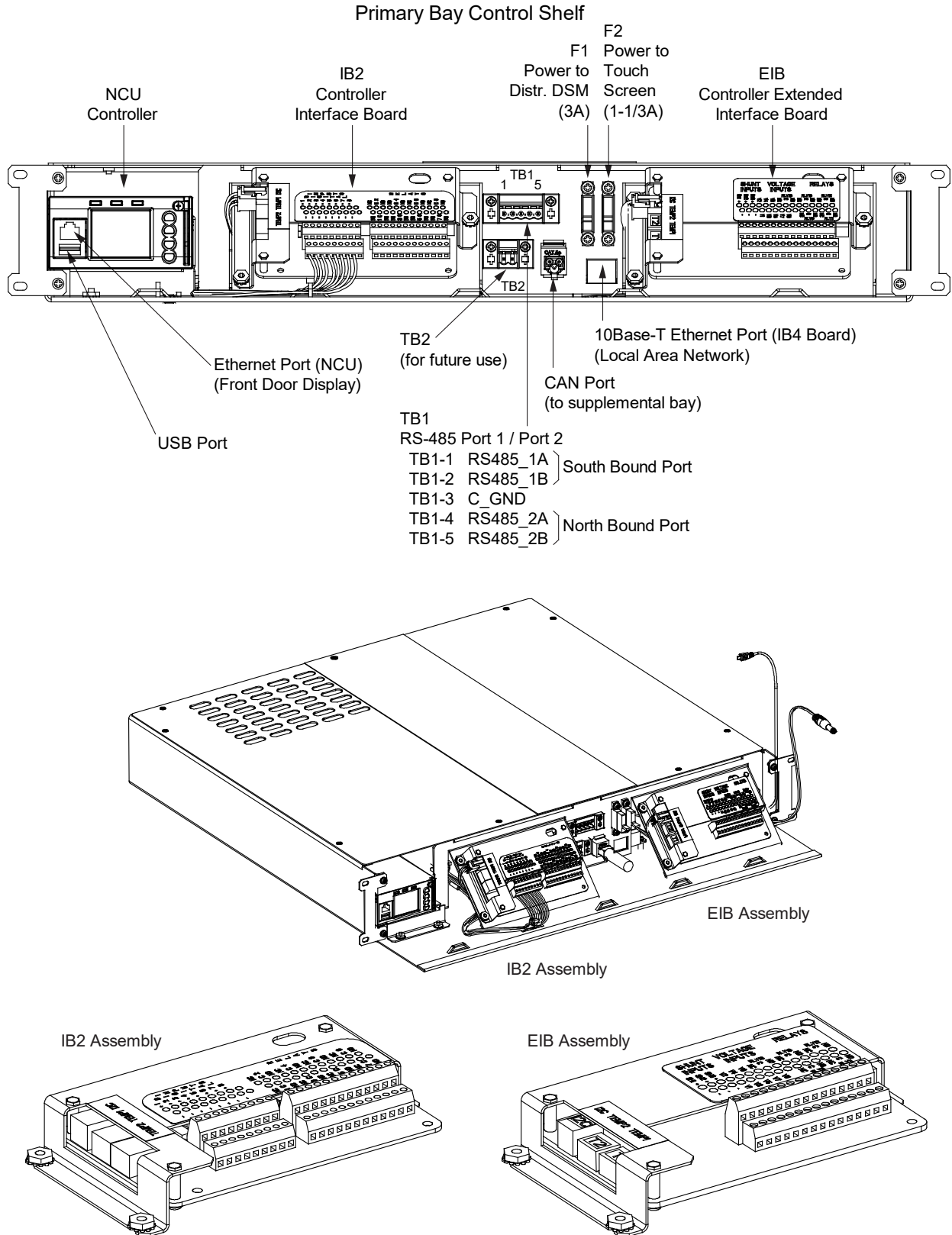

Figure 2.8 Detail D – Secondary Power/Distribution Bay or Secondary Power Only Bay System Monitoring and Control Section

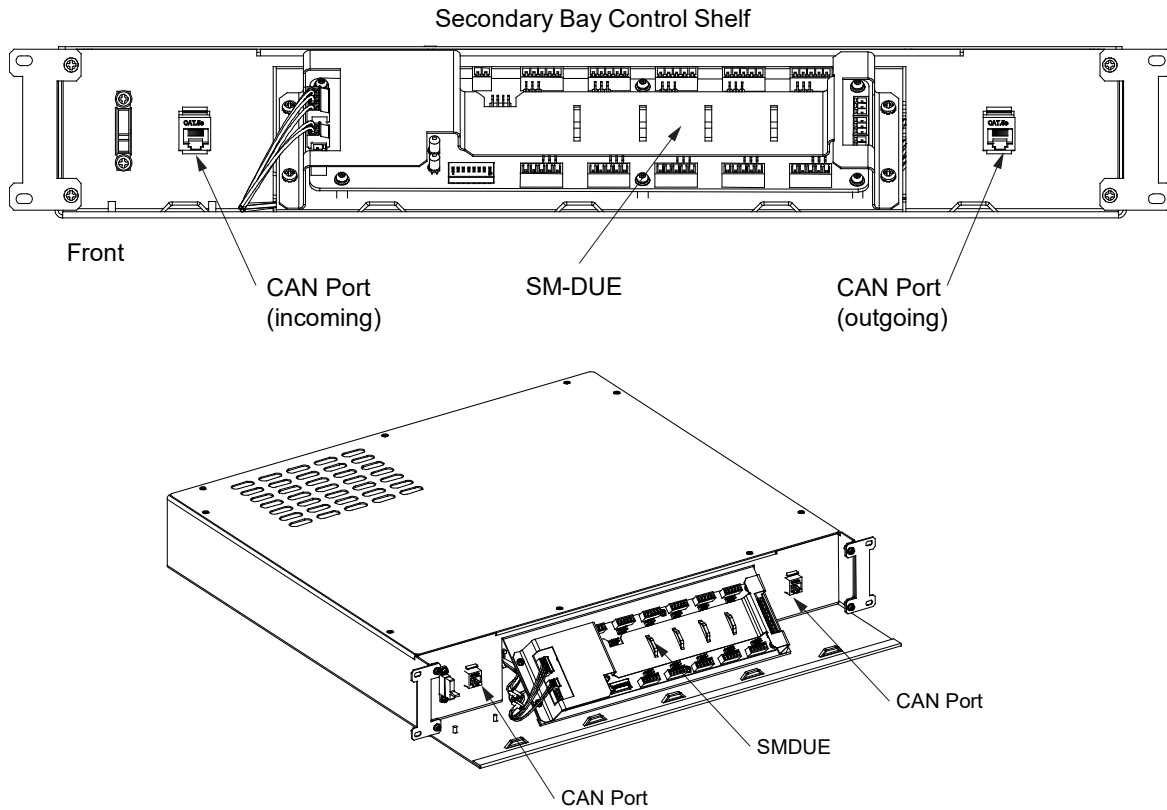

Figure 2.9 Detail E - Distribution Only Bays Monitoring and Control Section (List 116)

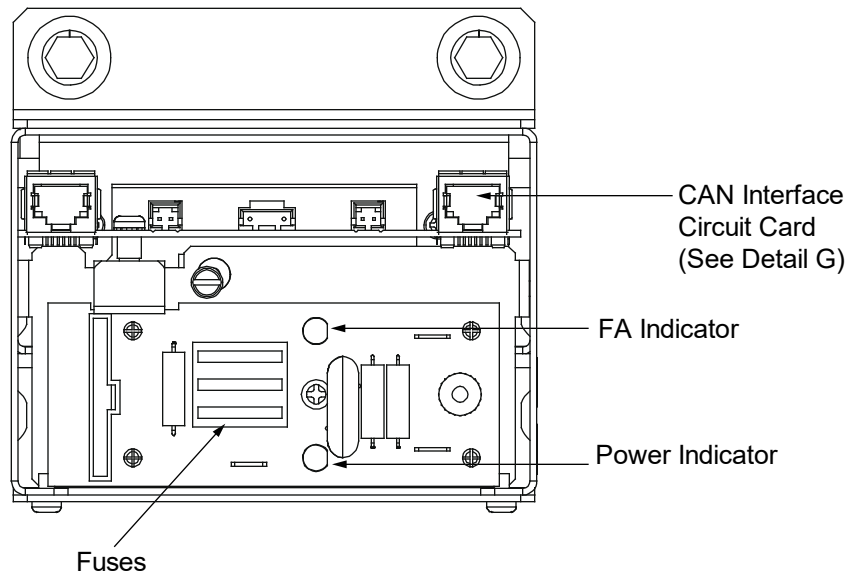

Figure 2.10 Detail F - Distribution Only Bays Monitoring and Control Section (List 117, 118, 122)

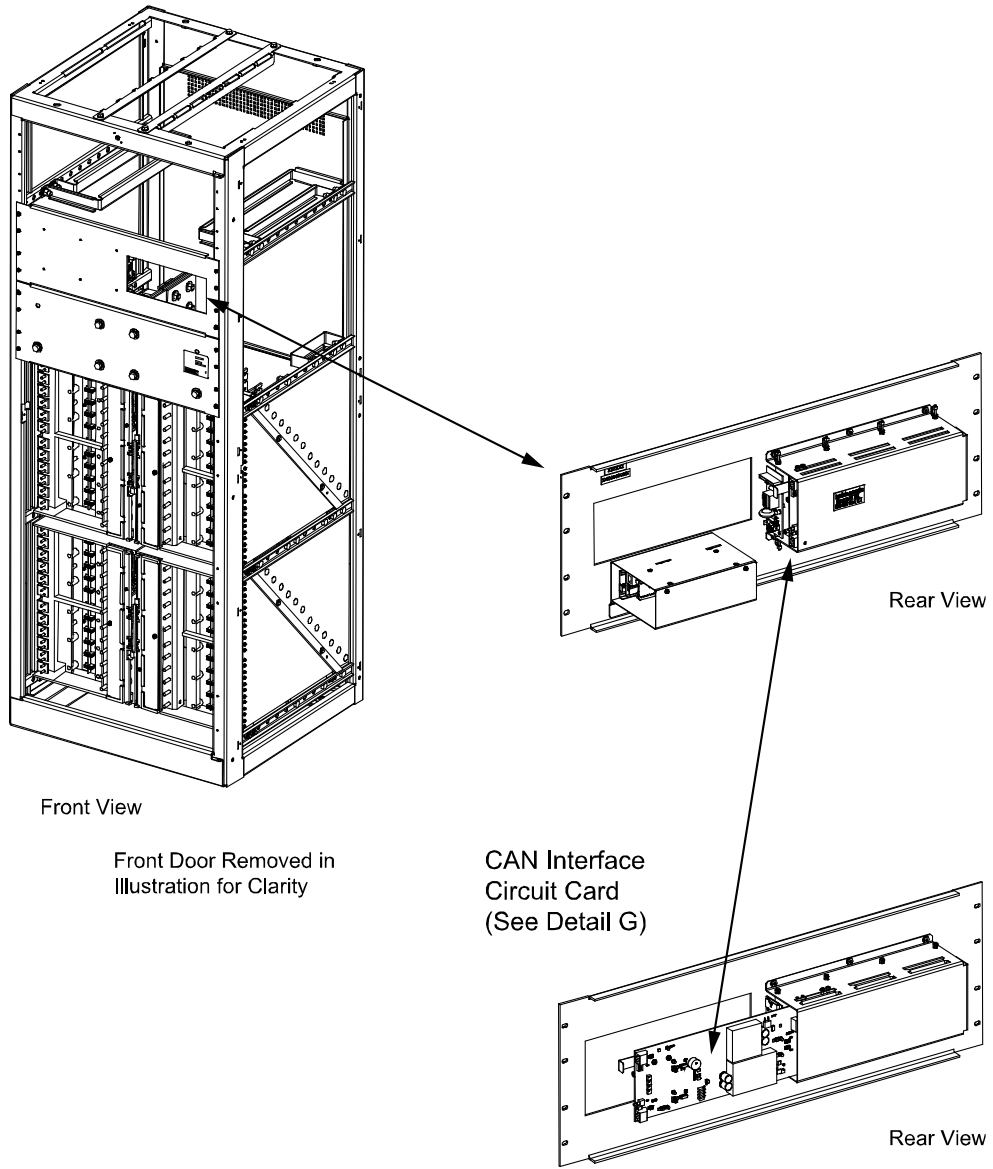
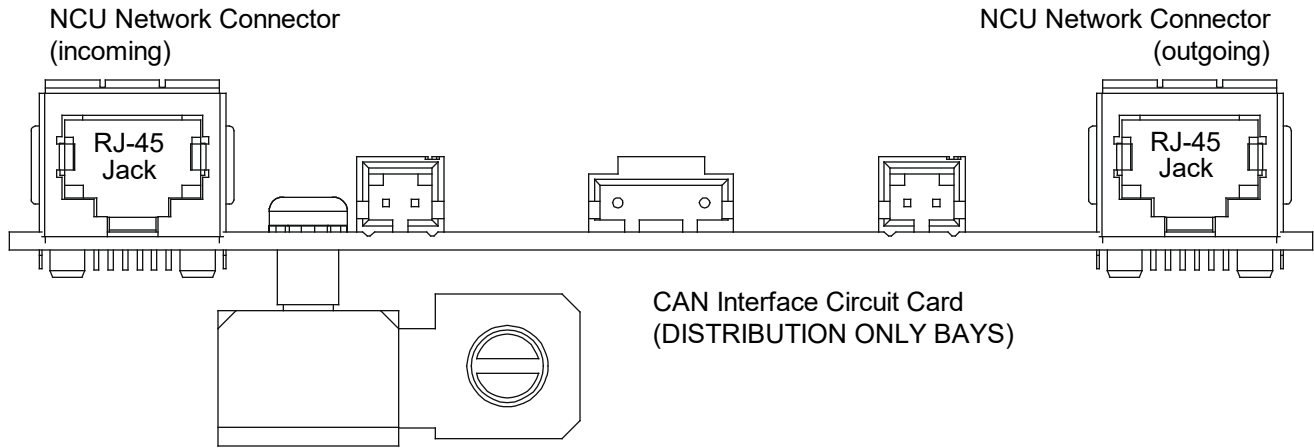

Figure 2.11 Detail G - CAN Interface Circuit Card (Distribution Only Bays)



3 System Operating Procedures

3.1 NCU Controller Operating Procedures

3.1.1 General



NOTE! For general operation instructions, refer to the NCU Controller User Manual (UM1M830BNA).

This system uses a special NCU configuration which allows intuitive naming of the bays and distribution elements. The NCU User Manual documents the names found in a standard NCU configuration. This section describes the differences in the NCU naming convention used in this special configuration as compared to a standard NCU configuration.

3.1.2 NCU Numbering Scheme

The NCU identifies (numbers) the components of the system as detailed in **Table 3.1**.

Table 3.1 NCU Numbering Scheme

Component	NCU Identification Number		
	NCU Numbering Scheme	Notes	Example
Bay	Bay #	Primary Bay is #1, other bays are numbered consecutively, following the bay-to-bay cabling scheme.	Primary Bay 1 Second Bay 2 Fifth Bay 5
Rectifier	NCU Rectifier ID#	Rectifiers are identified as they are powered-up and recognized by the NCU.	First Recognized Rectifier Rectifier 1 Tenth Recognized Rectifier Rectifier 10
Distribution Bus (Power/ Distribution Bays and Distribution Only Bays)	Bay # Top or Bottom Distribution Note: Bottom distribution only available in the distribution only bays.	Primary Bay is #1, other bays are numbered consecutively, following the bay-to-bay cabling scheme.	Primary Bay, Top Bus Bay 1 Top Dist Second Bay, Bottom Bus Bay 2 Bottom Dist Fifth Bay, Top Bus Bay 5 Top Dist
Distribution Device (Power/ Distribution Bays and Distribution Only Bays)	Load Bay # Distribution Point # within Bay	Primary Bay is #1, other bays are numbered consecutively, following the bay-to-bay cabling scheme. Distribution Point = 1-24 (left - right, Top Bus, Bus #1). 25-36 (left - right, Bottom Bus, Bus #2). Note that distribution components may take more than one mounting position, designation number is the left most mounting position.	Primary Bay, Circuit Breaker Mounted in Position One Load 1-1 Second Bay, Fuse Mounted in Position Sixteen Load 2-16 Fifth Bay, Plug-In Mounted in Position Twenty-Six Load 5-26

3.1.3 Inventory Screen

Refer to **Figure 3.1** for a sample of the inventory screen in this special NCU configuration.

The major differences here are that the distribution bus modules located in each distribution bay is named “Bay # Top or Bottom Dist”. The # is the bay number in the bay line-up. The distribution bus modules in each distribution bay monitors the bay’s load shunts; so any alarm, setting, etc. displayed by the NCU for these shunts references the “Bay # Top or Bottom Dist” naming convention.

Figure 3.1: Inventory Screen

System Inventory				
System Inventory				
Equipment	Product Model	Hardware Revision	Serial Number	Software Revision
NCU	M830B	A13	03180704729	1.2.10T13
Rectifier #1	486534003	A09	03180300105	1.21
Rectifier #2	486534003	A09	03180300113	1.21
Rectifier #3	486534003	A09	03180300315	1.21
Rectifier #4	486534003	A09	03180300323	1.21
Rectifier #5	486534003	A09	03180300326	1.21
Rectifier #6	486534003	A09	03180300327	1.21
Rectifier #7	486534003	A09	03180300328	1.21
Rectifier #8	486534003	A09	03180400371	1.21
Rectifier #9	486534001	A01	00000105182	1.13
Rectifier #10	486534001	A01	00000105204	1.13
EIB-1	1MA455U41	A01	03180102383	1.02
IB2-1	1MA4C5U31	A09	03180601730	1.03
BAY 1 TOP DIST	524982	A01	00031311835	1.10
BAY 2 TOP DIST	524982	A01	00030411214	1.10
SMDUE 1	1SMDUEA01	□24	03170300248	1.03

3.1.4 DC View Screen

When you click on the DC icon in the homepage, the DC view screen appears. A tab is provided in the DC view screen (SMDUP) to allow viewing the load value of each distribution point in the system. See **Figure 3.2**.

Figure 3.2: NCU DC View Screen

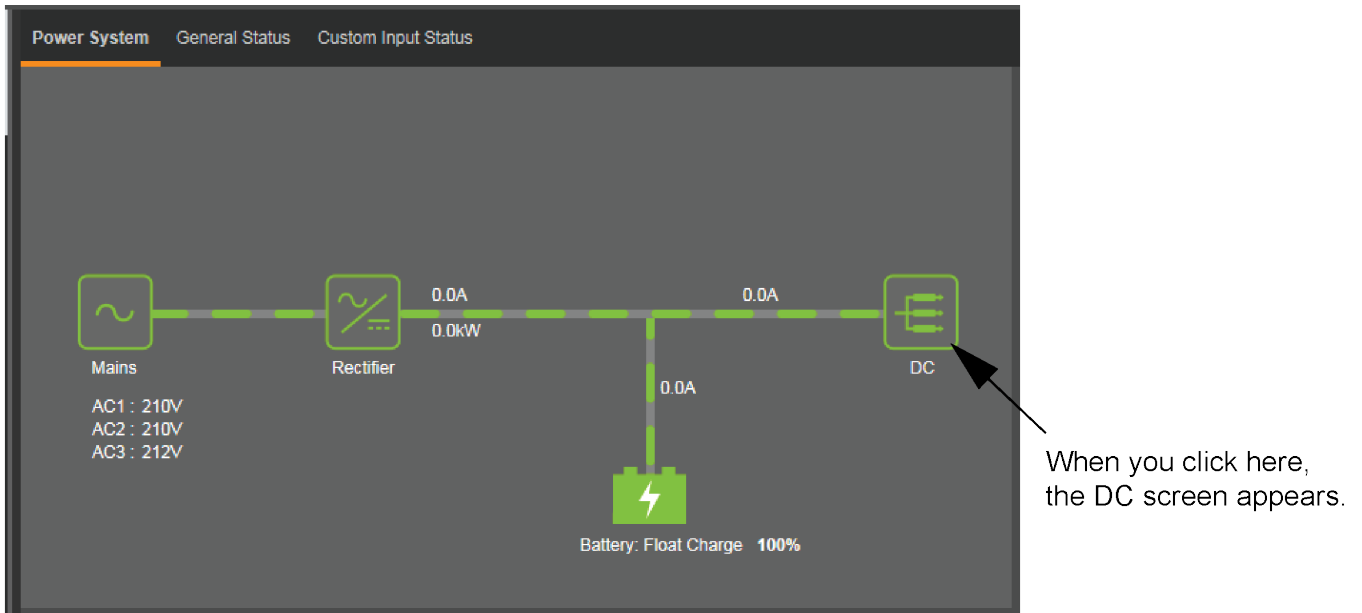

DC Screen, DC Tab

DC SMDUP EIB SMDUE

DC			
Signal	Value	Signal	Value
DC Voltage	52.0 V	Total Load Current	0.0 A

DC Screen, SMDUP Tab

DC SMDUP EIB SMDUE

BAY 1 TOP DIST			
Signal	Value	Signal	Value
Load 1-1	0.0 A	Load 1-7	0.0 A
Load 1-13	0.0 A	Load 1-19	0.0 A
Load 1-20	0.0 A		
BAY 2 TOP DIST			
Signal	Value	Signal	Value
Load 2-1	0.0 A	Load 2-7	0.0 A
Load 2-13	0.0 A	Load 2-19	0.0 A
Load 2-21	0.0 A	Load 2-22	0.0 A
Load 2-23	0.0 A	Load 2-24	0.0 A

3.1.5 Advanced Settings Screen

Shunts Tab

In this system's special NCU configuration, the Shunts tab in the “Advanced Settings Screen” allows the shunts for each distribution point to be configured. See **Figure 3.3**.

Figure 3.3: Advanced Settings Screen, Shunts Tab

Reference	Shunt Name	Modify/View
Shunt 1	Load 1-1	Modify/View
Shunt 2	Load 1-2	Modify/View
Shunt 3	Load 1-3	Modify/View
Shunt 4	Load 1-4	Modify/View
Shunt 5	Load 1-5	Modify/View
Shunt 6	Load 1-6	Modify/View
Shunt 7	Load 1-7	Modify/View

Alarms Tab

In this system's special NCU configuration, the Alarms tab in the “Advanced Settings Screen” groups the bay's alarms and lists the naming of each bay alarm in the configuration. See **Figure 3.4**.

Figure 3.4: Advanced Settings Screen, Alarms Tab

Index	Name	Alarm Level	Relay Number	Modify
1	Communication Fail	NA	None	Modify
2	Current1 High 1 Current	MN	None	Modify
3	Current1 High 2 Current	MN	None	Modify
4	Current2 High 1 Current	MN	None	Modify
5	Current2 High 2 Current	MN	None	Modify
6	Current3 High 1 Current	MN	None	Modify
7	Current3 High 2 Current	MN	None	Modify
8	Current4 High 1 Current	MN	None	Modify

Fuses Tab

In this system's special NCU configuration, the Fuses tab in the "Advanced Settings Screen" groups the bay's fuse alarms and lists the naming of each fuse alarm in the configuration. See **Figure 3.5**.

Figure 3.5: Advanced Settings Screen, Fuses Tab



3.2 Front Panel Touch Screen

The NCU controller's Ethernet port (192.168.100.100) is factory connected to a front panel touch screen. This allows local access to the NCU Webpages via the front panel touch screen.

Upon power up, an NCU login window appears on the touch screen. Touch in the User Name field, then enter a valid User Name. Touch in the Password field, then enter a valid Password. Then touch on LOGIN. The NCU "HOMEPAGE" window opens. Refer to the NCU controller instructions (UM1M830BNA) for webpage interface information.



NOTE! By default, the "User Name" is "admin" and the "Password" is "640275".



NOTE! An audible alarm can be silenced at any time by momentarily depressing the ENT key on the NCU controller or touching anywhere on the front panel touch screen.

The front panel touch screen goes into a sleep mode after a predetermined time period. A window displaying Plant Load, Plant Voltage, and any alarms is displayed in the center of the touch screen for a short period. This window then moves around the screen. Touch anywhere on the front panel touch screen to take the screen out of sleep mode. You must then log back into the NCU as described above.

3.3 NCU Battery Charge Current Limit Feature

Functionality: After a failure of the input source (commercial AC) or when some battery cells are permanently damaged, the current to the batteries can be quite extensive. To avoid overheating or further damages to the battery, the NCU can be programmed to limit the battery current to a preset level by limiting the charging voltage of the rectifiers. Should the battery current still exceed a higher preset value, an alarm is issued.

In this system, the NCU Battery Charge Current Limit feature is set to be disabled. Refer to NCU controller instructions (UM1M830BNA) to enable and program this feature, if desired. If enabled, battery charge current is limited to the value set in the NCU controller, as long as battery voltage is above 47 VDC.

3.4 Local Controls and Indicators

3.4.1 Controller

Refer to NCU controller instructions (UM1M830BNA) for descriptions of the local controls and indicators located on the NCU controller.

Bay LED Indicator

Located on the top front panel of each bay. See **Figure 2.1**, **Figure 2.2**, **Figure 2.3**, and **Figure 2.4** for location. See **Table 3.2** for indicator function.

Table 3.2: Bay LED Indicator

Indicator	Description
Green (steady)	Bay is 'OK'
Red (steady)	'Bay Failure'

Distribution Bus LED Indicator

Located next to each distribution bus (on the front of each distribution bus monitoring circuit card hinged panel) in each bay. See **Figure 2.1**, **Figure 2.3**, and **Figure 2.4** for location. See **Table 3.3** for indicator function.

Table 3.3: Distribution Bus LED Indicator

Indicator	Description
Green (steady)	Distribution Bus is 'OK'
Red (steady)	'Distribution Bus Failure'

SM-DUE Indicators

An SM-DUE is located on the control panel in each secondary power/distribution bay and secondary power only bay. Refer to **Figure 2.8** for SM-DUE location. There are two (2) status and alarm indicators located on the SM-DUE. Refer to **Figure 3.6** for location. The functions of these indicators are as shown in **Table 3.4**.

Table 3.4: SM-DUE Indicators

Indicator	Normal State	Fault State	Description
Operation (Green)	Flashing	--	Unit is operating normally.
	--	Off	Unit is non-operational.

Figure 3.6: SM-DUE Indicator Locations

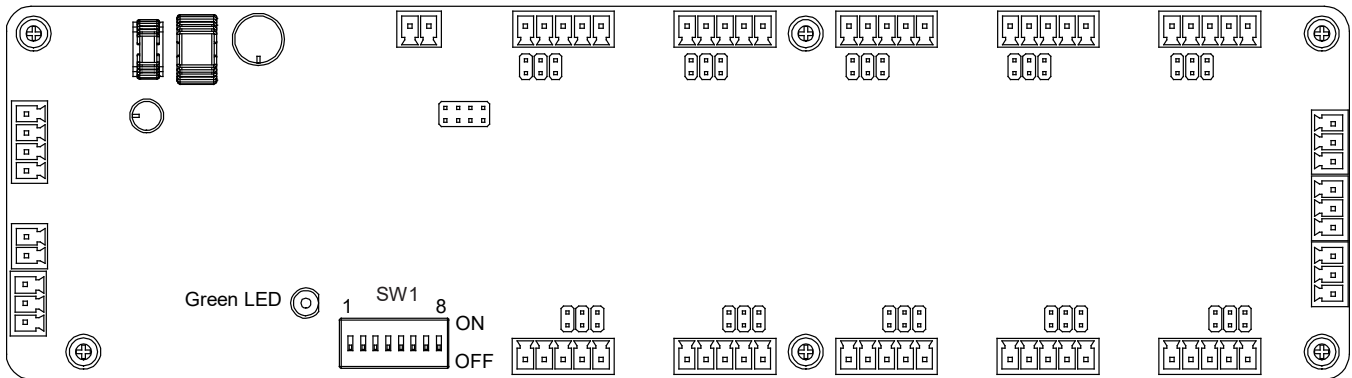

Rectifier Controls and Indicators (208V and 480V Input Rectifiers)

Refer to **Figure 2.6** for location and **Table 3.5** for descriptions.

Table 3.5: Rectifier Controls and Indicators

Control / Indicator	Description
Operate / Standby Switch	<p>This two positions rocker switch provides the following functions.</p> <p>I (Operate): Enables the rectifier to provide output power.</p> <p>⏻ (Standby): Inhibits rectifier output.</p> <p>Note: In standby mode, AC input power remains connected to the rectifier.</p>
AC / Identify Indicator	<p>This LED operates as follows.</p> <p>Steady green indicates AC input voltage to the rectifier is within the specified operating range and the Operate / Standby switch is in the 'Operate' position.</p> <p>Blinking yellow indicates the rectifier is being 'Identified' by the NCU.</p>
Protection Alarm Indicator	<p>This LED operates as follows.</p> <p>Steady YELLOW indicates:</p> <ul style="list-style-type: none"> AC input under/over voltage. Rectifier PFC output under/over voltage. High temperature. Current sharing imbalance. <p>Blinking YELLOW indicates:</p> <ul style="list-style-type: none"> Rectifier communication failure.
Fail Alarm Indicator	<p>This LED operates as follows.</p> <p>Steady RED indicates:</p> <ul style="list-style-type: none"> Output over-voltage. Output fuse blown. Rectifier ID fault. <p>Blinking red indicates:</p> <ul style="list-style-type: none"> Faulty fan.
OUTPUT CURRENT Bargraph	<p>Shows the rectifier's output current.</p> <p>Each LED segment represents 20 A. If the rectifier is in current limit (output current > 200 A), the tenth LED blinks.</p>

3.5 External Alarms

Relay outputs on the IB2 (NCU interface board) and EIB (NCU extended interface board) may be connected to external customer alarm circuits. Refer to the system installation instructions (IM58214-0000) and the configuration drawing (C-drawing) supplied with your power system documentation for your alarm relay configurations.

3.6 Starting and Stopping System Operation

Rectifier Starting Procedure

1. Place the rectifier Operate / Standby switch to the I "Operate" position. See **Figure 2.6** for location.

Rectifier Stopping Procedure

1. Place the rectifier Operate / Standby switch to the "Standby" position. See **Figure 2.6** for location.

3.7 Restarting Procedures when Rectifier is Automatically or Manually Inhibited, Shut Down, or Locked Out

Rectifier High Voltage Shutdown Lockout

Procedure

1. Place the rectifier Operate / Standby switch to the "Standby" position, and then back to the I "Operate" position.

Rectifier Emergency Shutdown and Fire Alarm Disconnect (ESTOP)



NOTE! *NCU ESTOP Function:* If an ESTOP switch is wired to the NCU IB2 interface board, customer-furnished system ground applied to terminal D18+ activates the ESTOP function. The ESTOP function shuts down and locks out the rectifiers. To restart the rectifiers; refer to the following procedure.

Procedure

1. Remove the emergency shutdown and fire alarm disconnect signal, and on each rectifier place the rectifier Operate / Standby switch to the "Standby" position and then back to the I "Operate" position.

4 System Maintenance

4.1 Important Safety Instructions



DANGER! Adhere to the "Important Safety Instructions" starting on page v.

4.2 System Maintenance Procedures

It is recommended to perform the maintenance procedures listed in **Table 4.1** every six (6) months to ensure continual system operation.

Table 4.1: Maintenance Procedures to be Performed at Six (6) Month Intervals

PROCEDURE	REFERENCED IN
Check ventilation openings for obstructions such as dust, papers, manuals, etc.	--
Inspect and tighten all installer's connections.	IM58214-0000, Making Electrical Connections section.

4.3 Adding a Rectifier



DANGER! Read the instructions on top of the rectifier before performing this procedure.

To increase system current capacity, an additional rectifier can easily be installed in an existing bay that contains an empty rectifier mounting position. Follow the procedure detailed below. A rectifier may be installed in a live system.

The rectifier weighs approximately 40 lbs.

Rectifiers can be inserted or removed with power applied (hot swappable).

Procedure

1. Remove the blank panel from the rectifier mounting position. Save this panel. The panel must be re-installed if a rectifier is removed.
2. Ensure that the Operate / Standby switch on the rectifier to be installed is in the "Standby" position.



NOTE! In the next step, a safety latch is present on the left-hand (as viewed from the front) side panel of each rectifier. The latch is designed to prevent the rectifier from inadvertently being removed completely from the bay once it has been installed. It should not be necessary to depress the safety latch release when installing the rectifier.

3. Install the rectifier into the bay by sliding it evenly into its mounting position. Secure the rectifier to the bay by tightening the captive fasteners on the rectifier.
4. Place the Operate / Standby switch on the rectifier installed to the "Operate" position.
5. It is recommended that the current limit point be checked whenever a rectifier is added to or removed from a bay. Refer to "Checking the NCU Current Limit Point after Adding or Removing a Rectifier" on page 22.
6. The rectifier being added is assigned by the NCU the lowest available identification number. If desired, you can change the identification number. See "Configuring the NCU Identification of Rectifiers after Adding a Rectifier" on page 23.
7. Ensure that there are no local or remote alarms activated on the system.

5 System Troubleshooting and Repair

5.1 Important Safety Instructions



DANGER! Adhere to the "Important Safety Instructions" starting on page v.

5.2 Contact Information

Refer to Section 4.15.4 (provided with your customer documentation) for support contact information.

5.3 Controller

General

Refer to the NCU controller instructions (UM1M830BNA) for troubleshooting and replacement instructions.

Controller Configuration

If any NCU controller configuration settings were changed, refer to the NCU controller instructions (UM1M830BNA) and save a copy of the configuration. The saved configuration can be used to restore the NCU controller settings, if required, at a later date.



NOTE! Provided on a USB drive furnished with the system is an NCU configuration drawing (C drawing) and the NCU configuration files loaded into the NCU as shipped.

5.4 SM-DUE

LED Indication Error

Requirement: When power is supplied to the SM-DUE, the “Operation” LED should flash.

Issue: SM-DUE “Operation” LED is OFF.

Possible Solutions: Check if the power input wiring of the SM-DUE is correct. Use a multimeter to check if the input voltage to the SM-DUE meets requirements. Check if the wiring of the other terminals is correct.

Incorrect Measurement Readings

Issue: The NCU is unable to obtain correct data when doing measurements.

Possible Solutions: Check if the SM-DUE jumper settings are correct. Check if the input wiring is securely connected to the proper terminals. Check if the input voltage to the SM-DUE is correct. Check if the input configuration is correct at the NCU. Check the CAN connection.

CAN Communication Failure

Issue: Communication through the CAN port fails.

Possible Solution: Check if the CAN port is correctly connected.

5.5 Troubleshooting Information

General

This system is designed for ease in troubleshooting and repair. The various indicators as described in “Local Controls and Indicators” starting on page 18 and in the controller instructions are designed to isolate failure to a specific element. Once the faulty element has been identified, refer to “Replacement Information” on page 24 and “Replacement Procedures” on page 24.

Troubleshooting Alarm Conditions on the NCU Controller

The NCU controller displays alarm conditions as listed in the “Resolving Alarms” section of the NCU controller instructions (UM1M830BNA). Programmable external alarm relays are also available. Refer to the system installation instructions (IM582140000) and the configuration drawing (C-drawing) supplied with your power system documentation for your alarm relay configurations.

The NCU’s **Active Alarm** and **Alarm History** submenus allow the User to view alarm details. Refer to the NCU controller instructions (UM1M830BNA) to access these menus.

Checking the NCU Current Limit Point after Adding or Removing a Rectifier

If a rectifier is added to the power system, the system current limit point will automatically increase by the percentage each existing rectifier was set to provide prior to the addition.

If a rectifier is removed from the system (and the Rect Comm Fail alarm is reset), the current limit point will remain unchanged unless the capacity of the remaining rectifiers is not sufficient to maintain the present current limit point. If that happens, the current limit point will automatically increase to the maximum (121% of the remaining rectifiers).

It is recommended that the current limit point be checked whenever a rectifier is added to or removed from the power system.

When setting total rectifier current limit, the set point to each unit is the total set point divided by the number of units. For example, if the system contains five rectifiers and the current limit is set to 150 amps then each rectifier has a current limit set point of 30 amps. If one or more rectifiers are removed or fail it will take several seconds for the individual set points to the remaining rectifiers to be reset. In the example given, if one rectifier is removed the current limit set point will drop to 120 amps (30 amps times four remaining

rectifiers) until the controller can send updated set points to the remaining rectifiers. This takes a couple communication cycles (several seconds) after which each rectifier would have a new set point of 37.5 amps for a total of 150 amps. The total current limit of the rectifiers should not be set such that the loss of the redundant rectifiers will cause this temporary set point to drop below the actual maximum expected load. If batteries are used on the rectifier output, the batteries should support the load until the current limit set points can be re-established due to loss of a rectifier.

Refer to the NCU controller instructions (UM1M830BNA) for a procedure.

Configuring the NCU Identification of Rectifiers after Adding a Rectifier

A rectifier that is added to the system is assigned by the NCU the lowest available identification number. If desired, you can change the identification number.

Refer to the NCU controller instructions (UM1M830BNA) for a procedure.

Clearing a Rectifier Communications Fail Alarm after Removing a Rectifier

If a rectifier is removed from the system, a rectifier communications failure alarm is generated. If the rectifier will not be replaced, the alarm should be cleared.

Refer to the NCU controller instructions (UM1M830BNA) for a procedure.

Clearing a Rectifier Lost Alarm

If the NCU controller resets while a rectifier communications fail alarm is active, the rectifier communications fail alarm is replaced with a rectifier lost alarm.

Refer to the NCU controller instructions (UM1M830BNA) for a procedure to clear the alarm.

Rectifier Current Sharing Unbalance

When multiple rectifiers are operating in parallel and the current sharing unbalance among them is greater than 3%, check if the communications cables are correctly connected.

If the current sharing unbalance still persists, following the verification suggested above, then replace the rectifier which has had its current sharing function disabled.

Clearing a DSM # Element Alarm

If a distribution device is removed, an Observation indication will occur (no audible alarm). To clear the alarm, go to the Home Page/Settings/System, then scroll down to the bottom to the DSM Inventory Update Signal, then click on SET. The alarm will clear.

Rectifier Fault Symptoms and Troubleshooting

The fault indicators that can be displayed by the rectifier are as follows: Power indicator (green) off, protection indicator (yellow) on, protection indicator (yellow) flashing, alarm indicator (red) on, and alarm indicator (red) flashing. Refer to **Figure 2.6** for indicator location. Refer to **Table 5.1** for a list of possible causes and corrective actions.

Table 5.1 Rectifier Troubleshooting

Symptom	Possible Cause(s)	Suggested Action(s)
Power Indicator (Green) Off	No input voltage.	Make sure there is input voltage.
	Input polarity reversed. Input fuse blown.	Reconnect the input power correctly. Replace the rectifier.
Protection Indicator (Yellow) On	AC input voltage outside the normal range.	Ensure that the AC input voltage is within the acceptable range.
	PFC over-voltage.	Replace the rectifier.
	Current sharing function is disabled.	Replace the rectifier.
	Rectifier not inserted into the slot completely.	Insert the rectifier again properly.
	Rectifier over-temperature protection, which could be caused by:	
	1. Fan blocked.	1. Remove any object that may be blocking the fan.
	2. Ventilation blocked (inlet or outlet).	2. Remove any object that may be blocking the inlet or outlet.
3. Ambient temperature too high or rectifier inlet too close to a heat source.	3. Lower the ambient temperature, relocate the heat source.	
Protection Indicator (Yellow) Flashing	Rectifier communication failure.	Check the communication cables.
Alarm Indicator (Red) On	Rectifier over-voltage.	Remove the rectifier from the DC power system, restart the rectifier, and replace the rectifier if the over-voltage condition still persists.
Alarm Indicator (Red) Flashing	Fan not operating.	Replace the rectifier.

5.6 Replacement Information

User Replaceable Components

When a trouble symptom is localized to a faulty rectifier, controller, or system circuit card; that particular device or circuit card should be replaced in its entirety. No attempt should be made to troubleshoot or repair individual components on any rectifier, controller, or circuit card.

Refer to SAG582140000 (System Application Guide) for replacement part numbers.

Replacement Cables

Refer to SAG582140000 (System Application Guide) for replacement part numbers.

5.7 Replacement Procedures

5.7.1 Important Safety Instructions



DANGER! Adhere to the “Important Safety Instructions” starting on page v.

5.7.2 Rectifier Replacement



DANGER! Read the instructions on top of the rectifier before performing this procedure.

The rectifier weighs approximately 40 lbs.

Rectifiers can be inserted or removed with power applied (hot swappable).

Procedure

1. Performing this procedure may activate external alarms. Do one of the following. If possible, disable these alarms. If these alarms cannot be easily disabled, notify the appropriate personnel to disregard any future alarms associated with this system.
2. On the rectifier to be removed, place the Operate / Standby switch to the "Standby" position.



NOTE! *In the next step, a safety latch is present on the left-hand (as viewed from the front) side panel of each rectifier. The latch is designed to prevent the rectifier from inadvertently being removed completely from the bay once it has been installed. It should not be necessary to depress the safety latch release when installing the rectifier.*

3. Loosen the captive fasteners on the front of the rectifier to be removed. Use the handle provided on the front of the rectifier, and pull the rectifier out until it is stopped by a safety latch located on the left-hand side panel of the rectifier. Refer to **Figure 5.1** for latch and release location. Depress and hold the latch release, and remove the rectifier from the shelf. Support the bottom of the rectifier as you pull it out. **Observe the instructions on top of the rectifier as you remove it.**
4. Ensure that the Operate / Standby switch on the replacement rectifier is in the "Standby" position.
5. Slide the replacement rectifier evenly into its mounting position. It should not be necessary to depress the safety latch release. Secure the rectifier to the bay by tightening the captive fasteners located on the rectifier.
6. Place the Operate / Standby switch on this rectifier to the "Operate" position.
7. The rectifier being replaced is assigned by the controller the lowest available identification number. If desired, you can change the identification number. Refer to the NCU controller instructions (UM1M830BNA) for a procedure.
8. Enable the external alarms, or notify appropriate personnel that this procedure is finished.
9. Ensure that there are no local or remote alarms active on the system.

Figure 5.1 208V and 480V Rectifiers

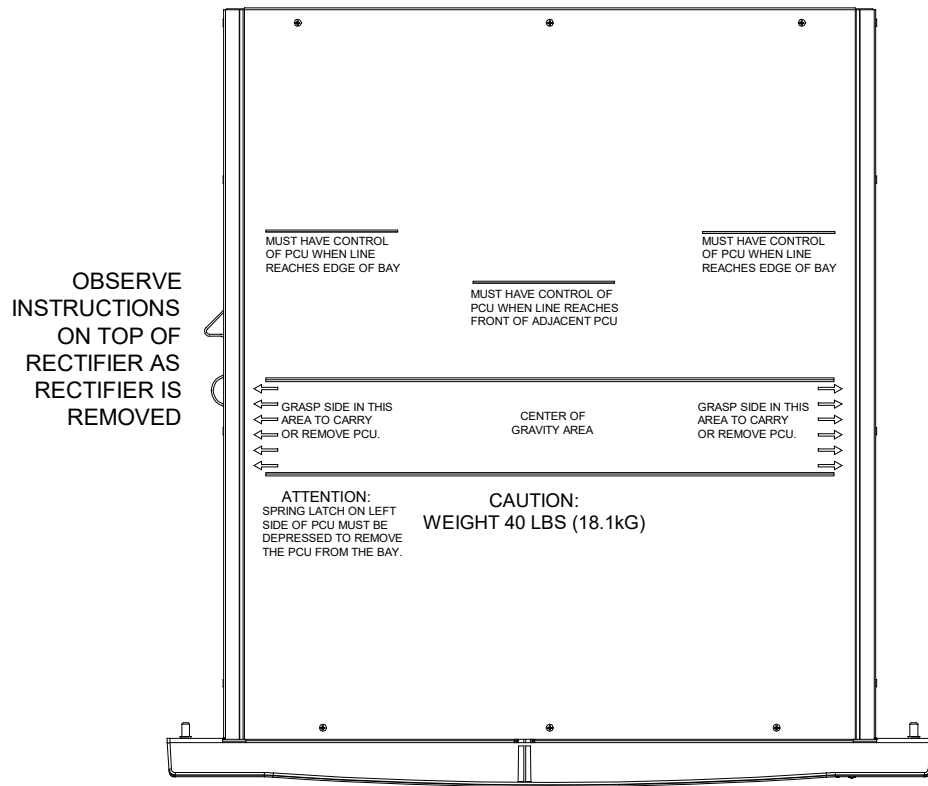
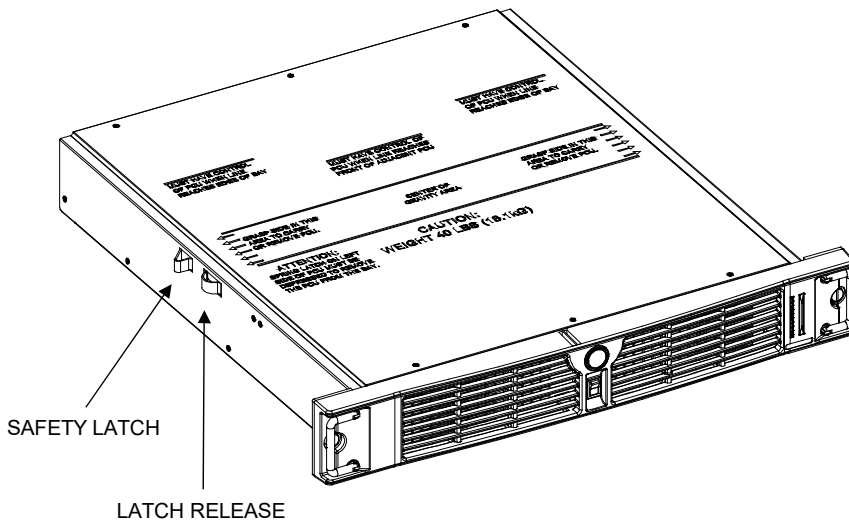

5.7.3 Replacing the NCU Controller

Refer to the NCU controller instructions (UM1M830BNA) for a replacement procedure.

5.7.4 Circuit Card Replacement Procedures

General

The following circuit card replacement procedures can be performed with the system operating.

Handling Equipment Containing Static Sensitive Components



ALERT! Circuit cards used in this power system contain static-sensitive devices. Read and follow the instructions contained in Section 4154 (provided with your customer documentation) before performing any of the following procedures.

IB2 (NCU Interface Board) and EIB (NCU Extended Interface Board) Replacement



NOTE! Refer to **Figure 2.7** for IB2 and EIB board location. Refer to **Figure 5.2** and **Figure 5.3** for circuit card illustrations.

Procedure

1. Performing this procedure may activate external alarms. Do one of the following. If possible, disable these alarms. If these alarms cannot be easily disabled, notify the appropriate personnel to disregard any future alarms associated with this system while the procedure is being performed.



DANGER! Performing the next steps may expose service personnel to hazardous potential. Exercise extreme caution not to inadvertently contact or have any tool inadvertently contact any energized electrical termination.

2. Open the bay's front door.



WARNING! Damage to the circuit card may result if the next step is not followed.

3. Connect an approved grounding strap to your wrist. Attach the other end to a suitable ground.
4. Carefully label the wires connected to the customer connection terminal blocks on the circuit card. These wires must be connected to the same terminals on the replacement circuit card. Refer to **Figure 5.2** or **Figure 5.3**.
5. Carefully label the connectors plugged into the circuit card. These connectors must be plugged into the same connectors on the replacement circuit card. Refer to **Figure 5.2** or **Figure 5.3**.



DANGER! In the next step, external alarm wiring may be energized from an external source. DO NOT allow bare wire ends to contact any grounded or energized object.

6. Remove the external wiring from the customer connection terminal blocks. DO NOT allow the bare wire end to contact any grounded or energized object. Isolate the wire end with electrical tape. Repeat for each wire to be removed.
7. Unplug all connectors plugged into the circuit card.
8. Remove the circuit card by removing the hardware securing the bracket the circuit card is mounted to from the power system. Remove the circuit card with bracket from the power system.
9. Remove the circuit card from the bracket.
10. In this step, ensure you do not intermix the old and replacement circuit cards. Set the switch on the replacement circuit card to the same setting as the old circuit card. Switch settings are documented in the "Making Switch Settings" section of the power system installation instructions (IM582140000).
11. Secure the replacement circuit card to the bracket. Re-install the circuit card and bracket into the bay.
12. Plug all connectors removed from the old circuit card into the same position on the replacement circuit card.



DANGER! In the next step, external alarm wiring may be energized from an external source. DO NOT allow bare wire ends to contact any grounded or energized object.

13. Reconnect the external wiring to the correct terminals on the customer connection terminal block. First remove the electrical tape that was applied to the bare wire end in a previous step. DO NOT allow the bare wire end to contact any grounded or energized object. After securing the wire, gently tug on the wire to ensure that it cannot be pulled out of the terminal block. Repeat for each wire to be reconnected.
14. Remove the grounding wrist strap.
15. Close the bay's front door and secure.
16. Enable the external alarms, or notify appropriate personnel that this procedure is finished.
17. Ensure that there are no local or remote alarms active on the system.

Figure 5.2 IB2 (NCU Interface Board) Connector Locations

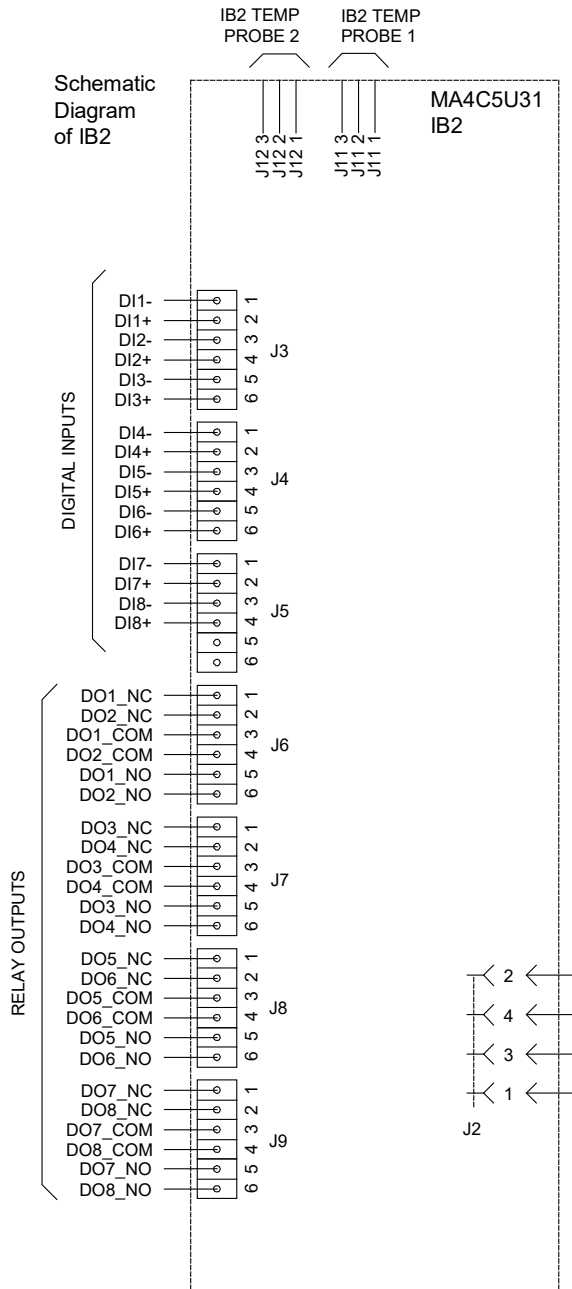

IB2 Assembly

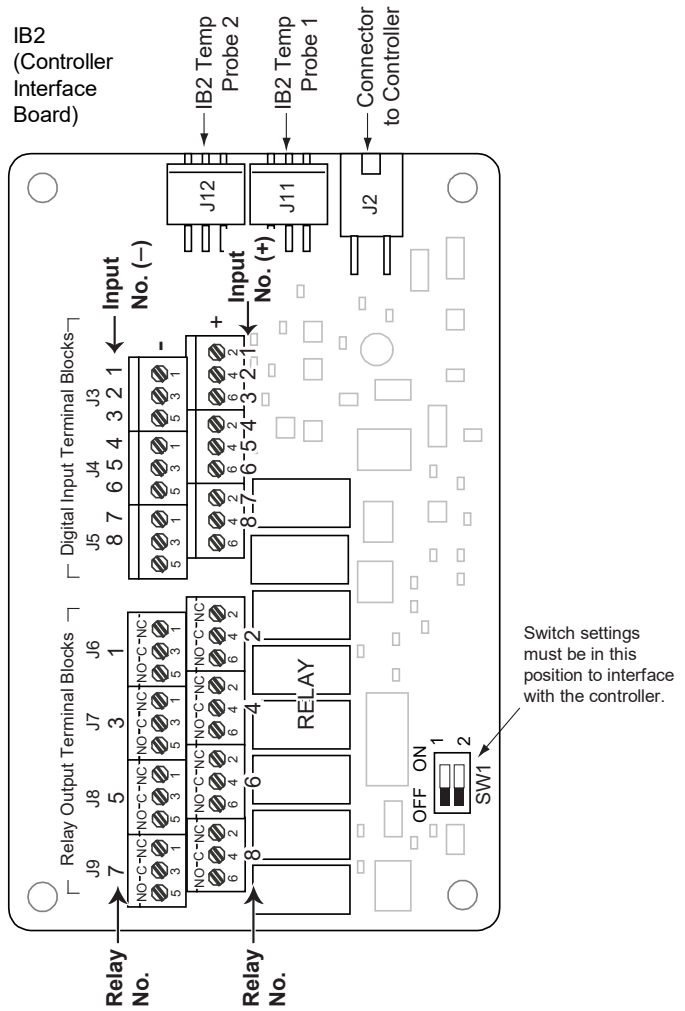
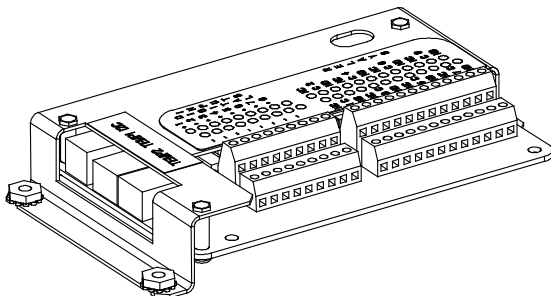

The controller relay assigned to "Critical Summary" alarm (relay 1 by default) will operate in the "Fail Safe Mode". "Fail Safe Mode" means Relay 1 is de-energized during an alarm condition, opening the contacts between the C and NO terminals, and closing the contacts between the C and NC terminals.

The controller's remaining seven (7) relays energize during an alarm condition, closing the contacts between the C and NO terminals, and opening the contacts between the C and NC terminals.

Not all I/O points may be available for customer connection (some may be used for factory system connections). Refer to the configuration drawing (C-drawing) supplied with your system for your system's specific configuration.

J3-J9:

Wire Size Capacity: 16 AWG to 26 AWG.

Wire Strip Length: 0.20 inch.

Recommended Torque: 2.2 in-lbs.

Figure 5.3 EIB (NCU Extended Interface Board) Connector Locations

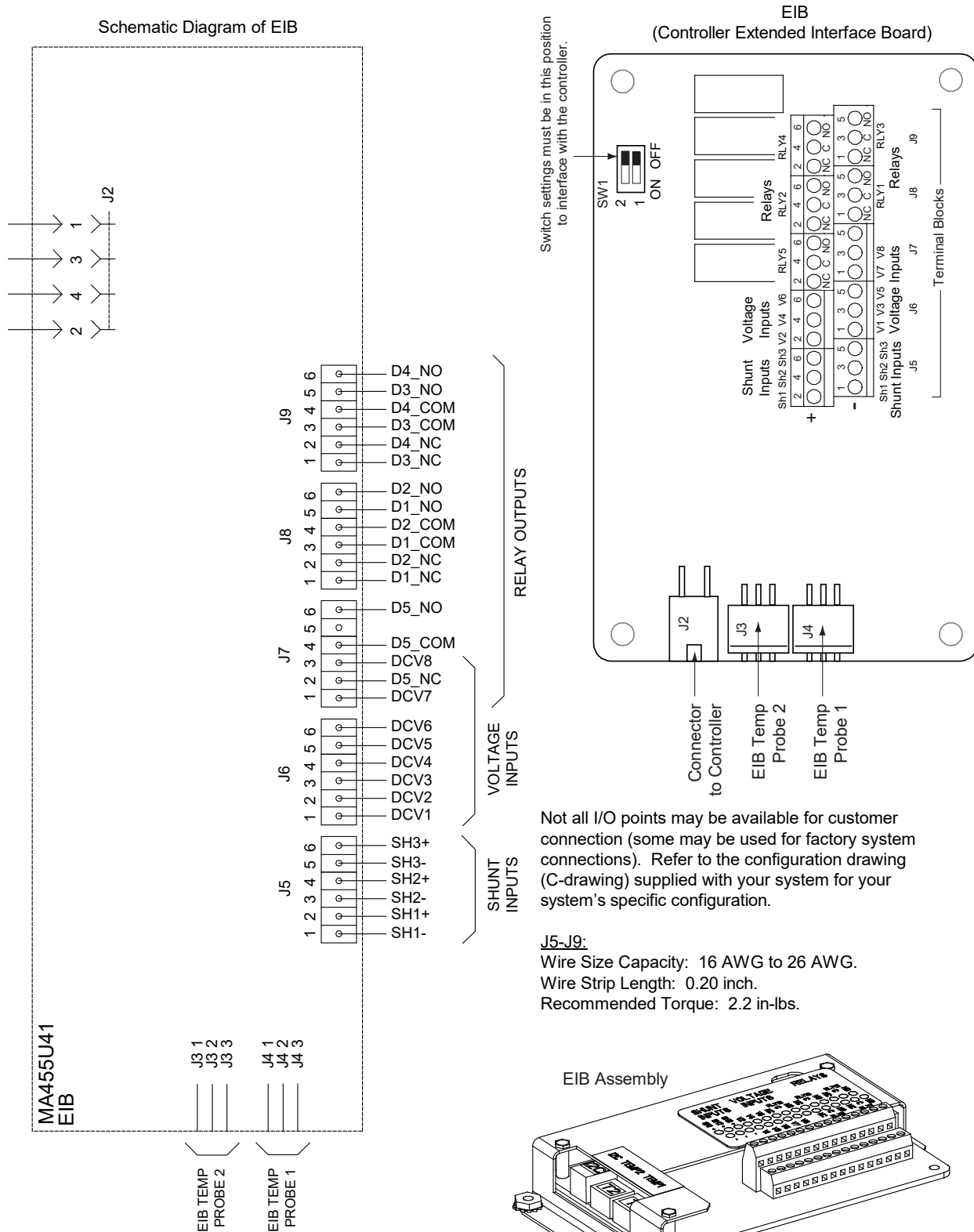

IB4 Board Replacement



NOTE! Refer to **Figure 2.7** for IB4 board location. Refer to **Figure 5.4** for circuit card illustration.

Procedure

1. Performing this procedure may activate external alarms. Do one of the following. If possible, disable these alarms. If these alarms cannot be easily disabled, notify the appropriate personnel to disregard any future alarms associated with this system while the procedure is being performed.



DANGER! Performing the next steps may expose service personnel to hazardous potential. Exercise extreme caution not to inadvertently contact or have any tool inadvertently contact any energized electrical termination.

2. Open the bay's front door.
3. Remove the control shelf from the bay.
4. Remove the top cover from the monitor and control shelf.



WARNING! Damage to the circuit card may result if the next step is not followed.

5. Connect an approved grounding strap to your wrist. Attach the other end to a suitable ground.
6. Carefully label the connectors plugged into the circuit card. These connectors must be plugged into the same connectors on the replacement circuit card.
7. Unplug all connectors plugged into the circuit card.
8. Remove the circuit card from the monitor and control shelf by removing the screws securing it to the shelf.
9. Orient the replacement circuit card over its mounting position, and secure with the screws removed from the old circuit card.
10. Plug all connectors removed from the old circuit card into the same position on the replacement circuit card.
11. Replace the control shelf into the bay.
12. Replace the monitor and control shelf top cover.
13. Remove the grounding wrist strap.
14. Reboot the NCU.

Local Menu Navigation:

At the Main Screen, press ENT and ESC at the same time to reboot the NCU controller.

Web Menu Navigation:

Advance Settings Menu / SW Maintenance Tab / Reboot Controller button.

15. Close the bay's front door and secure.
16. Enable the external alarms, or notify appropriate personnel that this procedure is finished.
17. Ensure that there are no local or remote alarms active on the system.

Figure 5.4 IB4 Circuit Card Replacement

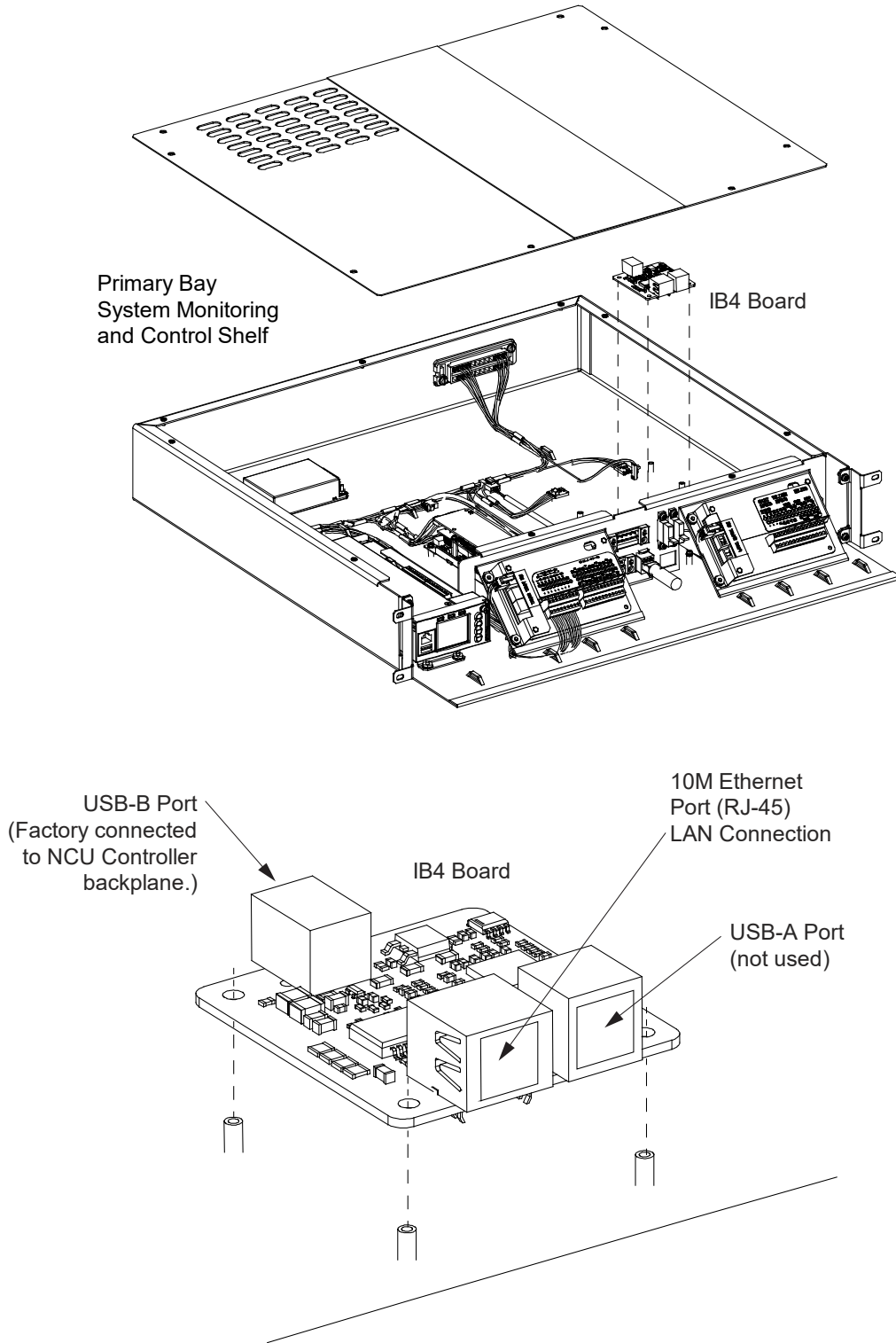

Distribution Bus Monitoring Circuit Card Replacement

Two distribution bus monitoring circuit cards are installed in each power/distribution bay.

Four distribution bus monitoring circuit cards are installed in each distribution only bay.



NOTE! Refer to **Figure 5.5** and **Figure 5.6** for distribution bus monitoring circuit card locations.

Procedure

1. Performing this procedure may activate external alarms. Do one of the following. If possible, disable these alarms. If these alarms cannot be easily disabled, notify the appropriate personnel to disregard any future alarms associated with this system while the procedure is being performed.



DANGER! Performing the next steps may expose service personnel to hazardous potential. Exercise extreme caution not to inadvertently contact or have any tool inadvertently contact any energized electrical termination.

2. Open the bay's front door to access the distribution bus monitoring circuit card mounting positions.



WARNING! Damage to the distribution bus monitoring circuit card may result if the next step is not followed.

3. Connect an approved grounding strap to your wrist. Attach the other end to a suitable ground.
4. Remove the fuse that supplies input power to the distribution bus monitoring circuit card. Refer to **Figure 5.8** , **Figure 5.9**, **Figure 5.10** , and **Figure 5.11** for location.
5. Open the hinged panel to access to distribution bus monitoring circuit card.
6. Remove the circuit card.
7. Slide the replacement circuit card into its mounting location, ensuring the rear edge connector is firmly seated.
8. Close the hinged panel.
9. Replace the fuse which supplies input power to the distribution bus monitoring circuit card. Refer to **Figure 5.8** , **Figure 5.9**, **Figure 5.10** , and **Figure 5.11** for location.
10. Remove the grounding wrist strap.
11. Close the bay's front door.
12. Enable the external alarms, or notify appropriate personnel that this procedure is finished.
13. Ensure that there are no local or remote alarms active on the system.

Figure 5.5 Power/Distribution Bay Distribution Bus Monitoring Circuit Card Replacement

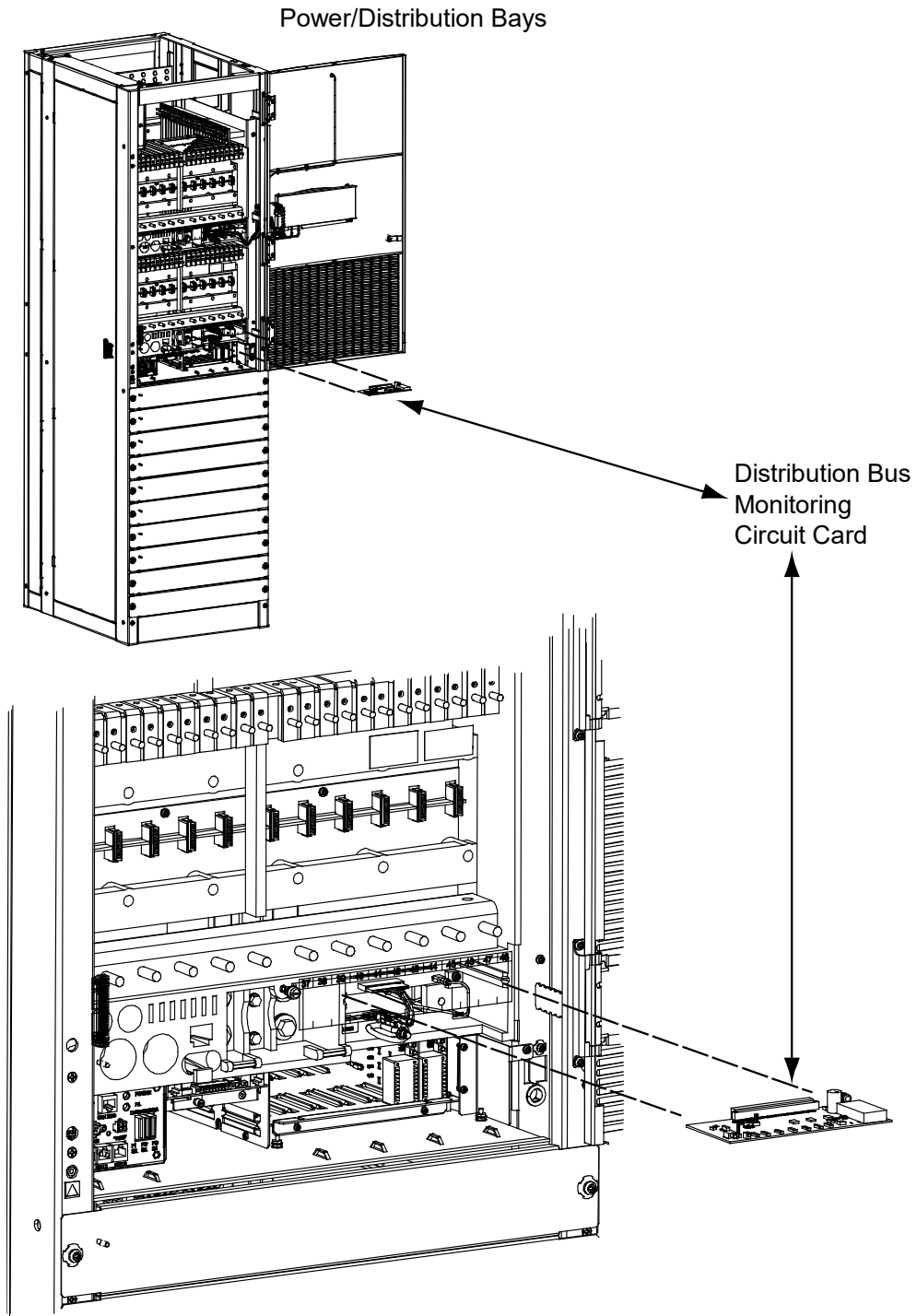
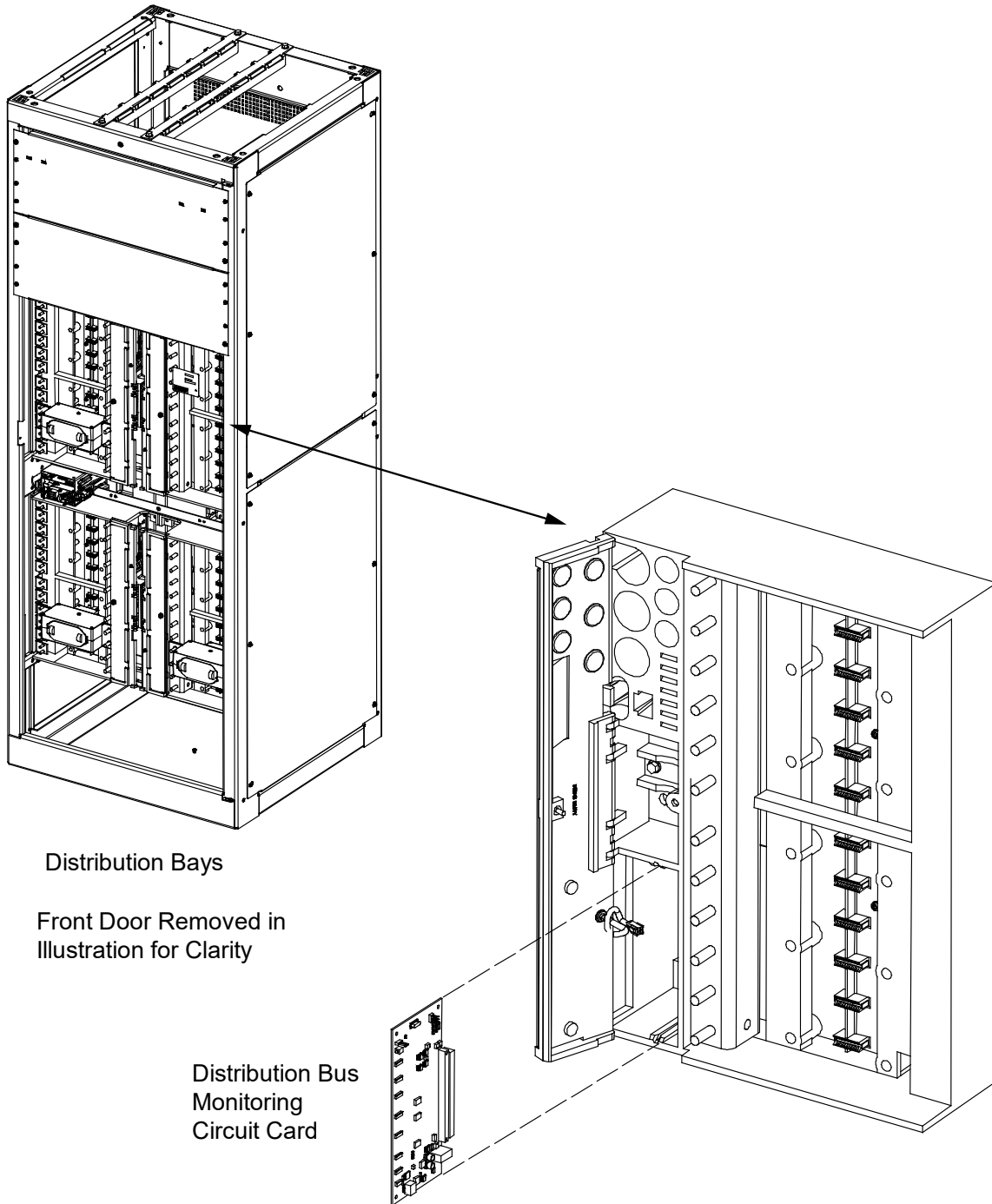

Figure 5.6 Distribution Only Bay Distribution Bus Monitoring Circuit Card Replacement



SM-DUE Circuit Card Replacement



NOTE! Refer to **Figure 2.8** for SM-DUE circuit card location. Refer to **Figure 5.7** for circuit card illustration.

Procedure

1. Performing this procedure may activate external alarms. Do one of the following. If possible, disable these alarms. If these alarms cannot be easily disabled, notify the appropriate personnel to disregard any future alarms associated with this system while the procedure is being performed.



DANGER! Performing the next steps may expose service personnel to hazardous potential. Exercise extreme caution not to inadvertently contact or have any tool inadvertently contact any energized electrical termination.

2. Open the bay's front door.
3. Remove the metal shield that is covering the circuit card.



WARNING! Damage to the circuit card may result if the next step is not followed.

4. Connect an approved grounding strap to your wrist. Attach the other end to a suitable ground.
5. The SM-DUE contains two-piece connectors that can be separated so they can be removed without removing the individual wires. Carefully label the connectors plugged into the circuit card. These connectors must be plugged into the same mating connector on the replacement circuit card. Refer to **Figure 5.7**.
6. Unplug all connectors plugged into the SM-DUE circuit card. **REMOVE THE POWER CONNECTOR (J12) FIRST.**
7. Remove the circuit card from the bay by removing the screws securing.
8. In this step, ensure you do not intermix the old and replacement circuit cards. Set the switches and jumpers on the replacement circuit card to the same setting as the old circuit card. See also "Switch Settings on SM-DUE" and "Jumper Settings on SM-DUE" in the power system installation manual (IM582140000).
9. Orient the replacement circuit card over its mounting position inside the bay, and secure with the screws removed from the old circuit card.
10. Replace the metal shield that is covering the circuit card.
11. Plug all connectors removed from the old circuit card into the same position on the replacement circuit card. **PLUG THE POWER CONNECTOR (J12) LAST.**
12. Remove the grounding wrist strap.
13. Temporarily remove then re-insert the NCU. Wait for the NCU to initialize.
14. Enable the external alarms, or notify appropriate personnel that this procedure is finished.
15. Ensure that there are no local or remote alarms active on the system.

Figure 5.7 Replacing the SM-DUE Circuit Card

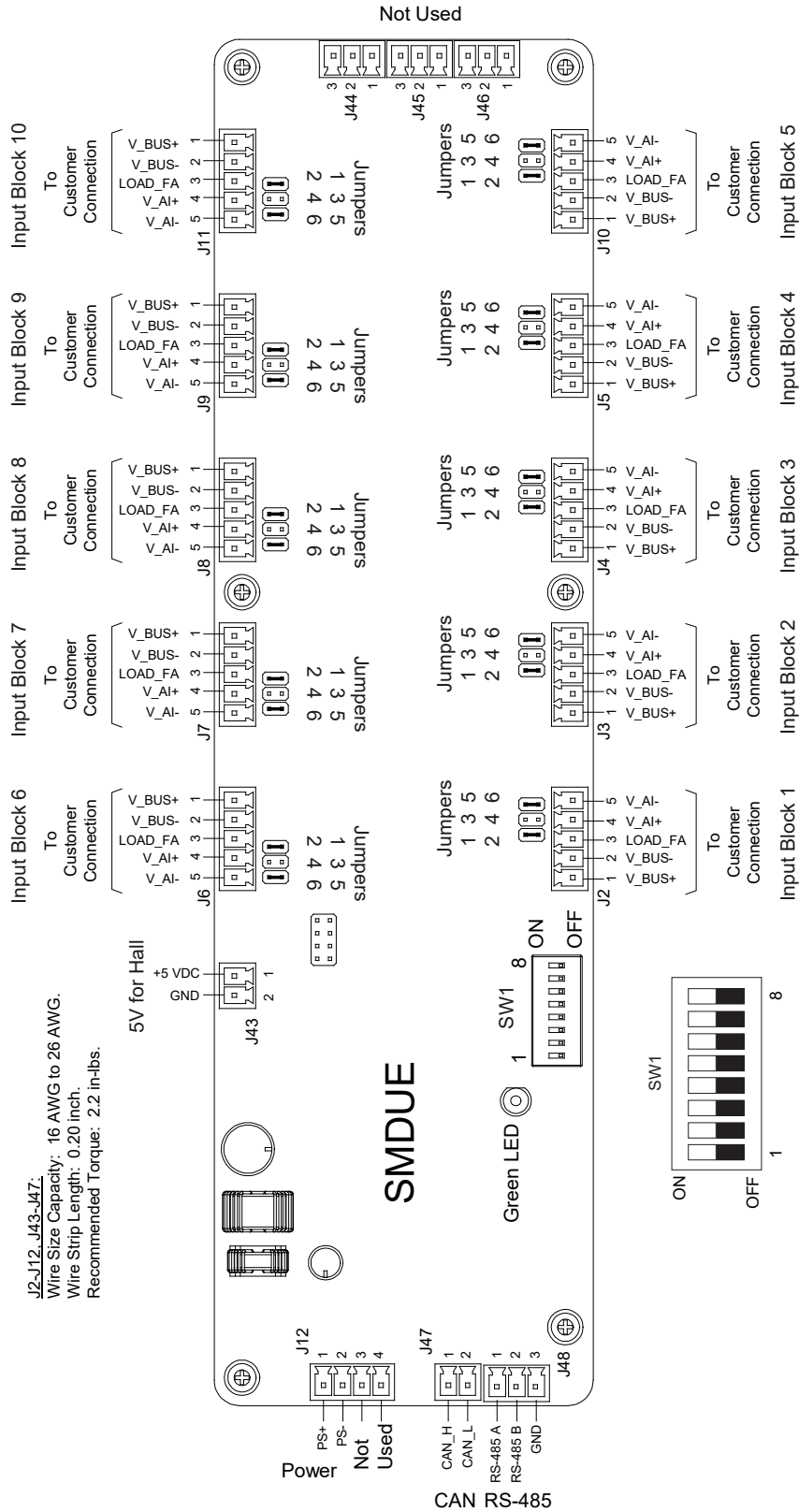

Alarm, Reference, and Control Fuse Replacement

If an alarm, reference, or control fuse opens; replace with the same type and rating, or equivalent. Refer to SAG58214-0000 for fuse replacement part numbers. Refer to Figure 5.8, Figure 5.9, Figure 5.10, and Figure 5.11 for alarm, reference, and control fuse locations.

Rectifier: The input of each rectifier contains double pole/neutral fusing. This fusing is not customer replaceable. If a fuse opens, replace the entire rectifier. An open fuse causes the rectifiers Rectifier Fail Alarm circuit to activate. The input fuses have higher amperage ratings than the recommended external branch circuit protection.

Distribution Fuses: If a distribution fuse opens, the associated alarm-type fuse opens to activate the fuse alarm circuit. Replace the distribution fuse before replacing the alarm-type fuse.

Safety Fuse Covers: Safety fuse covers are provided for all alarm-type fuses installed in the system. These covers snap onto the fuses and provide protection from exposed electrical terminations when a fuse opens. Ensure that the safety fuse cover is installed after replacing a fuse. Refer to Figure 5.12 for installation details. Note that there are different types of safety fuse covers for the different brand alarm-type fuses.

Figure 5.8 Primary Power/Distribution Bay and Primary Power Only Bay Monitoring and Control Section Fuse Locations

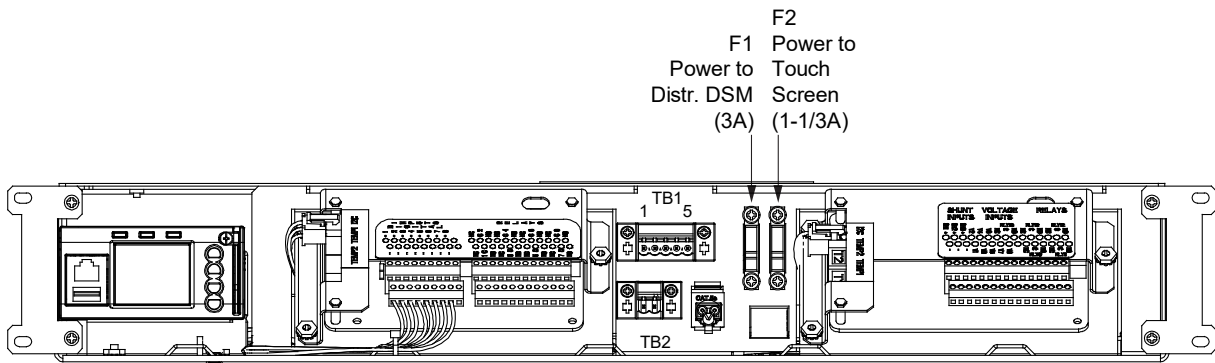

Primary Bay Monitor and Control Shelf (Front)

Figure 5.9 Secondary Power/Distribution Bay and Secondary Power Only Bay Monitoring and Control Section Fuse Locations

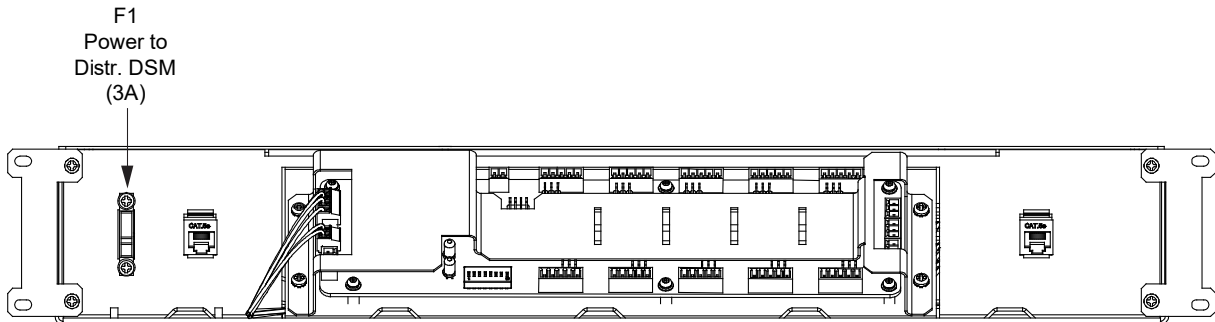

Secondary Bay Monitor and Control Shelf (Front)

Figure 5.10 Distribution Only Bay Monitoring and Control Section Fuse Locations (List 116)

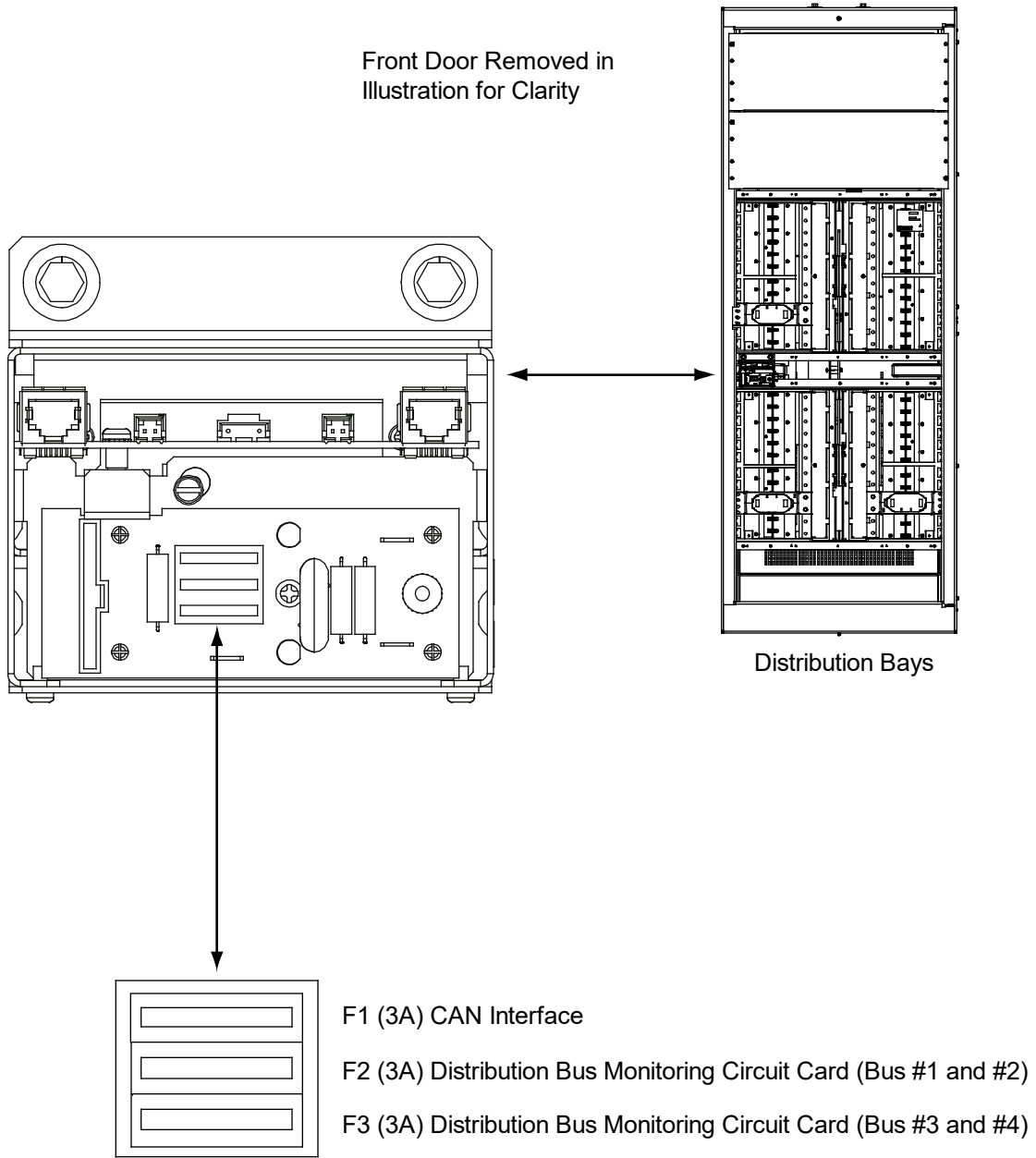

Figure 5.11 Distribution Only Bay Monitoring and Control Section Fuse Locations (List 117, 118, 122)

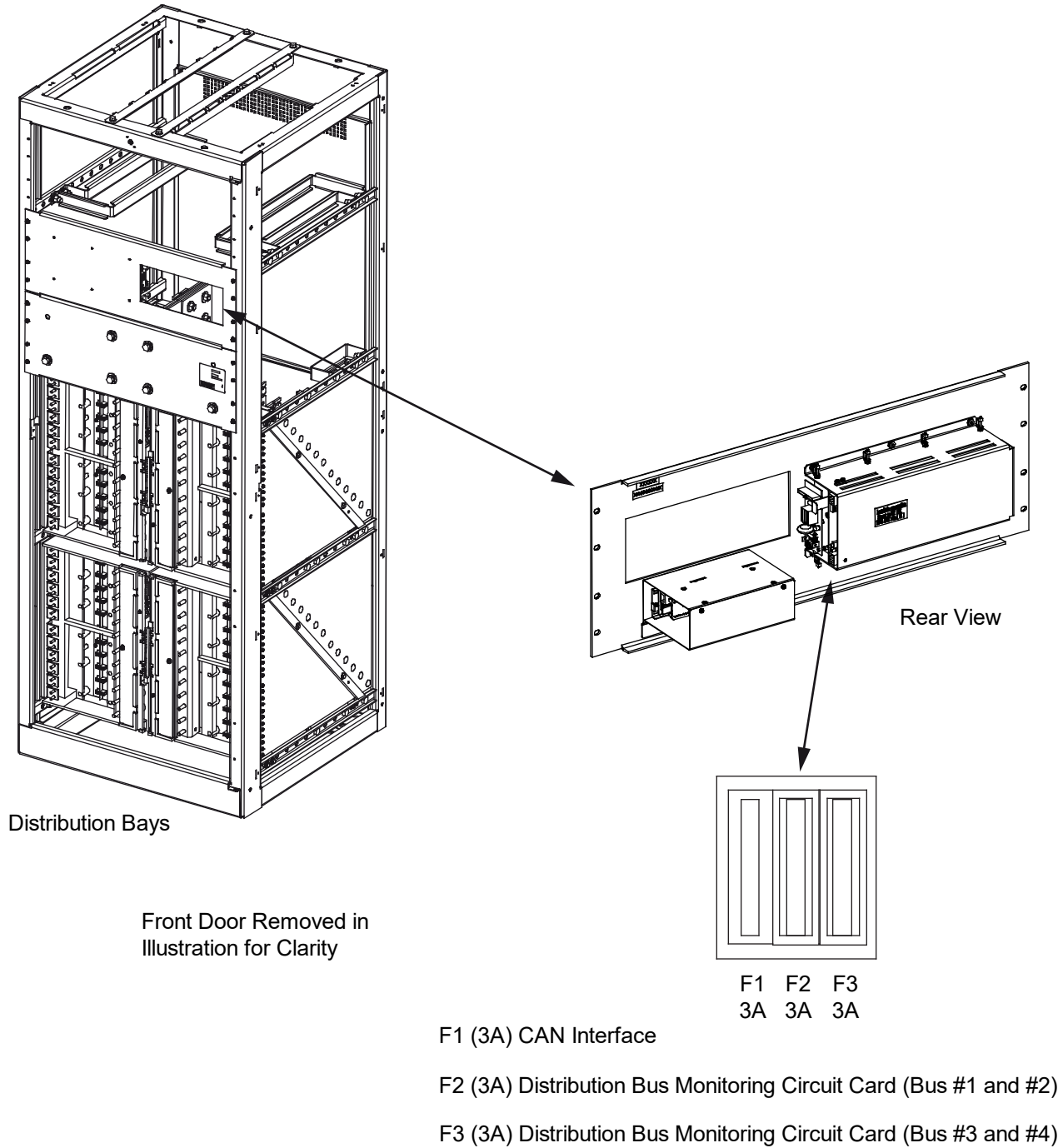
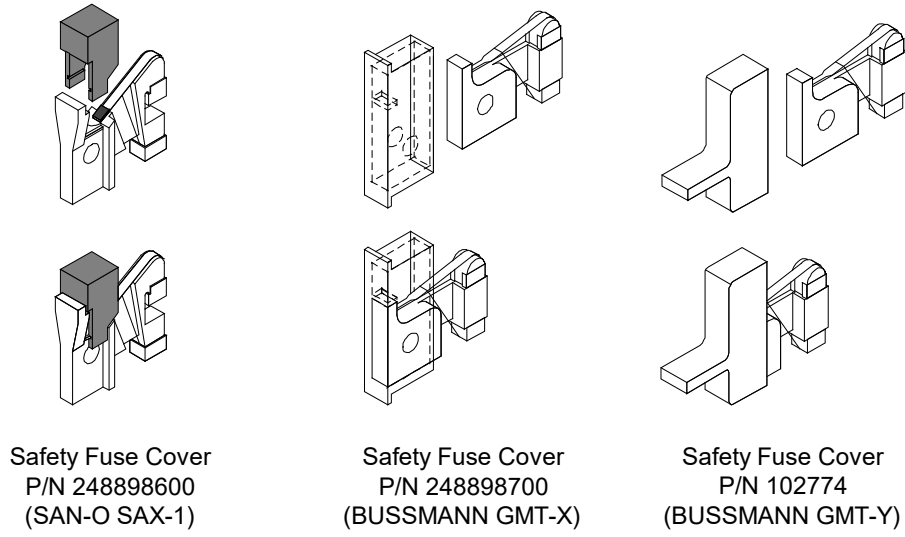

Figure 5.12 Installation of Safety Fuse Covers



Rectifier Fan Replacement

The rectifier fans are not field-replaceable. If a fan fails, replace the rectifier as described in this section.



CAUTION! In a system with NO redundant rectifier, battery must have sufficient reserve to power the load(s) while the rectifier is removed.

This page intentionally left blank.

Connect with Vertiv on Social Media



<https://www.facebook.com/vertiv/>



<https://www.instagram.com/vertiv/>



<https://www.linkedin.com/company/vertiv/>



<https://www.twitter.com/vertiv/>



Vertiv.com | Vertiv Headquarters, 505 N Cleveland Ave, Westerville, OH 43082, USA

© 2023 Vertiv Group Corp. All rights reserved. Vertiv™ and the Vertiv logo are trademarks or registered trademarks of Vertiv Group Corp. All other names and logos referred to are trade names, trademarks or registered trademarks of their respective owners. While every precaution has been taken to ensure accuracy and completeness here, Vertiv Group Corp. assumes no responsibility, and disclaims all liability, for damages resulting from use of this information or for any errors or omissions.