



APM2 Lithium Battery Module

Installer/User Guide

The information contained in this document is subject to change without notice and may not be suitable for all applications. While every precaution has been taken to ensure the accuracy and completeness of this document, Vertiv assumes no responsibility and disclaims all liability for damages result from use of this information or for any errors or omissions.

Refer to local regulations and building codes relating to the application, installation, and operation of this product. The consulting engineer, installer, and/or end user is responsible for compliance with all applicable laws and regulations relation to the application, installation, and operation of this product.

The products covered by this instruction manual are manufactured and/or sold by Vertiv. This document is the property of Vertiv and contains confidential and proprietary information owned by Vertiv. Any copying, use, or disclosure of it without the written permission of Vertiv is strictly prohibited.

Names of companies and products are trademarks or registered trademarks of the respective companies. Any questions regarding usage of trademark names should be directed to the original manufacturer.

Technical Support Site

If you encounter any installation or operational issues with your product, check the pertinent section of this manual to see if the issue can be resolved by following outlined procedures.

Visit <https://www.vertiv.com/en-us/support/> for additional assistance.

TABLE OF CONTENTS

1 Important Safety Instructions	1
1.1 Personnel Safety	1
1.2 Product Safety	1
1.3 Disclaimer	1
1.4 Safety Precaution	1
2 Overview	5
2.1 Product Features	5
2.1.1 Intelligent pairing with UPS products	5
2.1.2 Perfect battery protection	5
2.1.3 Easy installation and maintenance	5
2.1.4 Ultra-high energy density	5
2.2 Product Applications	5
2.2.1 Compatible models	5
2.2.2 System structure	6
2.3 Module Appearance	7
2.4 Working Principle	9
2.4.1 Modular design	9
2.4.2 Module status	10
2.5 Introduction of Liebert® APM2 Lithium Battery Module	10
2.5.1 Battery module	10
2.5.2 Electrical control components	11
3 Installation Instructions	13
3.1 Prerequisites	13
3.2 Preparation for Installation	13
3.2.1 Tools	13
3.2.2 Confirmation of UPS installation environment	15
3.3 Handling and Unpacking	15
3.3.1 Carrying lithium battery modules	15
3.3.2 Unpacking	16
3.3.3 Re-check before installation	17
3.4 Lithium Battery Module Installation	17
4 Startup, Operation, and Commissioning	19
4.1 Notes	19
4.2 Powering ON and OFF	19
4.2.1 Power-on	19
4.2.2 Power-off	20
4.2.3 Emergency power-off	20

- 4.3 UPS Power-ON Test 20
- 4.4 Commissioning Record List 22
- 4.5 Lithium Battery Module Paramset Set Up 22
- 5 Operation Control Display Panel 27**
- 5.1 Overview 27
- 5.2 LED Display 34
- 5.3 Operation of Touchscreen 35
 - 5.3.1 Access level login 35
 - 5.3.2 Touchscreens 36
- 5.4 Alarm List 37
- 6 Product Specification 39**
- 6.1 Applicable Standards 39
- 6.2 Environmental Characteristics 39
- 6.3 Mechanical Characteristics 40
- 6.4 Electrical Characteristics 40
- 7 Maintenance and Service 43**
- 7.1 Maintenance Precautions 43
- 7.2 Routine Maintenance 43
- 7.3 Module Replacement 43
- 7.4 Routine Maintenance 45
 - 7.4.1 General 45
 - 7.4.2 Diagnosis of common problems 45
 - 7.4.3 Emergency management 45
- 7.5 Maintenance Record of Lithium Battery Module 46
- 8 Packaging, Transportation, Storage 47**
- 8.1 Package 47
- 8.2 Transport 47
- 8.3 Storage 47
- Appendices 49**
- Appendix A: Technical Support and Contacts 49
- Appendix B: Battery Backup Timetable 50
- Appendix C: Hazardous Substances and Content 52

1 Important Safety Instructions

1.1 Personnel Safety

A Vertiv authorized engineer must install and commission the UPS. Failure to do so can cause product malfunction or personal safety risk.

Read the UPS manual and safety precaution carefully, failure to do so can cause product malfunction or personal safety risk.

NOTE: The Vertiv™ Liebert® APM2 UPS is not manufactured to support the life support equipment.

Never dispose of the internal or external battery of this product in a fire, as it may explode can cause risk of personal safety.

1.2 Product Safety

- If this product will be stored or remain de-energized for a long period, it must be placed in a dry and clean environment within specified temperature range.
- This product should be used in an appropriate operating environment. For details, refer to the section on the environmental requirement in this manual.
- This product is designed for application in the following conditions:
 - Where the temperature and relative humidity are outside the specifications.
 - Is not subjected to vibrations or shocks.
 - Where conductive dusts, corrosive gases, salts, or flammable gases are not present.
 - Away from heat sources or strong electromagnetic interferences.

1.3 Disclaimer

Vertiv disclaims all responsibility and/or liability for any defects or malfunction caused by the following actions:

- Any use or operation outside of the [Product Specification](#) on page 39, including application ranges or operating environments.
- Any unauthorized product operations, modifications, or improper installation.
- Any forceful measures used when operating the product.
- Any other product related actions not in compliance with the instructions in this document.

If user need product assistance or have additional product questions, contact Vertiv technical support representative.

1.4 Safety Precaution

Always pay attention to the following safety symbols.



WARNING! It is used to alert the user to the risk of death or severe injury if the unit is used improperly.



AVERTISSEMENT! Utilisé pour avertir l'utilisateur du risque de mort ou de blessure grave en cas d'utilisation incorrecte de l'appareil.



CAUTION: It is used to alert the user to the risk of injury or equipment damage if the unit be used improperly.

IMPORTANT! It is used to advise the user to carefully read and observe this unit though it may not cause damage.



ATTENTION: Ce terme est utilisé pour avertir l'utilisateur des risques de blessures ou de dommages matériels en cas d'utilisation incorrecte de l'appareil.

IMPORTANT! Ce terme est utilisé pour conseiller à l'utilisateur de lire et d'observer attentivement cet appareil, bien qu'il ne puisse pas causer de dommages.

This manual contains the installation and use of the Vertiv™ Liebert® APM2 lithium battery module. Vertiv recommends to read this manual carefully before system installation and operation.



CAUTION: Risk of improperly maintenance and commissioning of Liebert® APM2 lithium battery modules. Can cause personal injury and equipment damage. To avoid this, the Liebert® APM2 lithium battery modules must be maintained and commissioned only by Vertiv engineer or its agent. The resulting damage to the equipment is not covered by the warranty.



ATTENTION: Risque de maintenance et de mise en service incorrectes des modules de batterie au lithium Liebert® APM2. Peut entraîner des blessures corporelles et des dommages matériels. Pour éviter cela, les modules de batterie au lithium Liebert® APM2 doivent être entretenus et mis en service uniquement par l'ingénieur Vertiv ou son agent. Les dommages causés à l'équipement ne sont pas couverts par la garantie. Traduit avec DeepL.com (version gratuite).

Applicable standards

- This equipment complies with CE 2014/35/EU (Low Voltage Safety), 2014/30/EU (EMC) and 2011/65/EU (RoHS), as well as the following product standards:
 - *IEC62040-1 general safety requirements for use of operating areas
 - *IEC62040-2 EMC, Class C3
- The equipment must be installed in accordance with the above requirements and using the accessories specified by the manufacturer.

Battery safety instructions

- When installing and applying Liebert® APM2 lithium battery module products, refer to the user manual before use.
- Check the orientation of the positive and negative terminals before installation and removal.
- Terminals or wires to the Liebert® APM2 lithium battery module, use insulated tools, and pay attention to insulation protection against short circuits.
- When not in use for a long period of time, the battery should be stored in a cool and dry place ($\leq 35^{\circ}\text{C}$, 30% or more SOC, and charge/discharge the whole machine every six months).
- Do not place the battery in direct sunlight or near a heat source.

- Do not wear metal jewelry (such as rings, watches, ornaments, and so on) when touching the Liebert® APM2 lithium battery module.
- Do not place the battery outside the operating temperature range specified in this manual.

Equipment maintenance

- All internal maintenance and servicing of the equipment requires the use of tools and should be carried out by trained personnel. Devices behind protective covers that require the use of tools to open are not user serviceable.
- The Liebert® APM2 lithium battery module fully meets the safety requirements for equipment in the area of use and operation. The Liebert® APM2 lithium battery module carries hazardous voltages internally, but is not accessible to non-maintenance personnel. There is no hazard in operating the equipment in compliance with general specifications and following the steps recommended in this manual.



WARNING! Power cables must be routed in a metal raceway or metal floor trough to prevent cable damage and reduce electromagnetic radiation.



AVERTISSEMENT! Les câbles d'alimentation doivent être acheminés dans un chemin de fer ou une goulotte métallique afin d'éviter d'endommager les câbles et de réduire les radiations électromagnétiques.



WARNING! Prohibit wiring inside the Vertiv™ Liebert® APM2 lithium battery module cabinet that is not related to this equipment.



AVERTISSEMENT! Interdisez tout câblage à l'intérieur de l'armoire du module de batterie au lithium Vertiv™ Liebert® APM2 qui n'est pas lié à cet équipement.

Prohibitions

- Do not exceed the maximum allowable charge/discharge ratio.
- Do not disassemble or modify the lithium module.
- Do not throw or hit the lithium module.
- Do not pierce the lithium module with sharp objects (such as nails, knives, pens, drills, and so on).
- Do not mix with other models of lithium modules.
- Do not squeeze the lithium module during use.
- Do not leave the battery in a place where the temperature is higher than 60°C.
- Do not place the battery in a microwave oven or a high pressure container.
- Do not connect the positive and negative terminals with conductive materials (such as metal, wires, and so on).
- It is not permitted to wet or immerse the battery in water or seawater.
- Do not use the batteries in ways other than in the manufacturer's user manual.
- The use of products with poor insulation protection of the lithium module case is prohibited.

Battery voltage exceeds 200 VDC

- All physical care and maintenance of batteries requires the use of tools or keys and should be carried out by trained personnel.
- When the batteries are connected, the voltage at the battery terminals will exceed 200 VDC, making personal contact fatal.
- The manufacturer has provided precautions to be observed when using or in the vicinity of lithium modules, which should be observed at all times. Particular attention should be paid to the recommendations concerning local environmental conditions and the provision of protective clothing, first aid equipment and fire fighting equipment.

IMPORTANT! The communication board is sensitive to electrostatic discharge, implement ESD prevention measures when managing any communication board.

Preventing battery short circuit hazards

- A short circuit of the battery will cause an instantaneous high current, which will release a large amount of energy and may cause fire and other accidents, jeopardizing the safety of persons and property.
- It is prohibited to work with electricity, during installation, maintenance, and other operations, the battery circuit needs to be disconnected from the front panel air switch to keep the system disconnected.
- The use of insulated tools is required during installation and maintenance, goggles and rubber gloves should be worn before installation, maintenance and other operations.
- When installing and connecting copper rows or cables between lithium modules, user need to be accompanied by safety personnel.
- When installing and connecting the lithium module, it is necessary to lock the bolts according to the torque required by the manual.
- Battery products are not permitted to be near sources of ignition or water, not even a small sporadic fire or water droplets.
- Vertiv™ Liebert® APM2 lithium battery modules and their battery modules are not waterproof or dustproof.

IMPORTANT! Dispose the batteries in accordance with local laws and regulations.

NOTICE

The lithium battery deployment room needs to be equipped with fire protection facilities. Heptafluoropropane, perfluorohexanone, dry powder extinguishing, and firefighting sand are recommended.

This manual covers following module:

Table 1.1 Module

Product	Model Number
Liebert® APM2 Lithium battery module	APM 0120kBLI01
<p>NOTE: Rated voltage of single module: 237.6 V, capacity 14 Ah.</p> <p>NOTE: Battery cluster rated voltage: 475.2 V, capacity 14 Ah.</p> <p>NOTE: Battery cluster rated voltage: 237.6 V, capacity 14 Ah.</p>	

NOTE: Battery cluster refers to a battery pack formed after a single module is connected in series. For this 400 V and 480 V UPS system, clusters 1 and 2 form one group, while clusters 3 and 4, 5 and 6, and 7 and 8 form other groups. For 208 V UPS systems, 1 is a cluster, and 2, 3, 4, 5, 6, 7, 8 are other clusters.

2 Overview

This chapter describes the features, product introduction, system design, and key component functions of the Vertiv™ Liebert® APM2 lithium battery module.

2.1 Product Features

Liebert® APM2 lithium battery module is a ternary lithium battery product, which is used with the APM2 120k UPS and APM2 60k UPS to provide backup energy storage. The Liebert® APM2 lithium battery module, supports multiple battery clusters to meet the requirements of different capacity UPS configuration. The product has the following features:

2.1.1 Intelligent pairing with UPS products

Liebert® APM2 lithium battery module communicates with UPS through CAN communication, ensures the real time exchange of operating data, and intelligent protection and monitoring, program upgrade feature is available with UPS HMI over RS-485 communication mode.

2.1.2 Perfect battery protection

The battery management system (BMS) of the Liebert® APM2 lithium battery module has a perfect battery protection function to ensure the automatic and safe operation of the system. The system works independently when UPS communication is abnormal and protects battery cluster systems. Provide managed, predictable, and uninterrupted power supply to critical equipment.

2.1.3 Easy installation and maintenance

The Liebert® APM2 lithium battery module has a redundant design that supports quick online maintenance, and the module can be replaced in less than 3 minutes.

2.1.4 Ultra-high energy density

The system adopts ternary lithium battery, which has high energy storage density, small height, and volume and long service life expected to be 10 to 12 years.

2.2 Product Applications

2.2.1 Compatible models

Table 2.1 Compatible Model

Product Name	Product External Model	Remark
APM2.0 120 kVA UPS Frame1 400 V	APM 0120kMH16FY02S00	CE
APM2.0 120 kVA UPS Frame1 480 V	APM 0120kMA46FY02000	UL
APM2.0 60 kVA UPS Frame1 208 V	APM 0060kMA46FY02000	UL

2.2.2 System structure

Figure 2.1 Vertiv™ Liebert® APM2 Lithium Battery Module Structure (120 kVA 400 V)

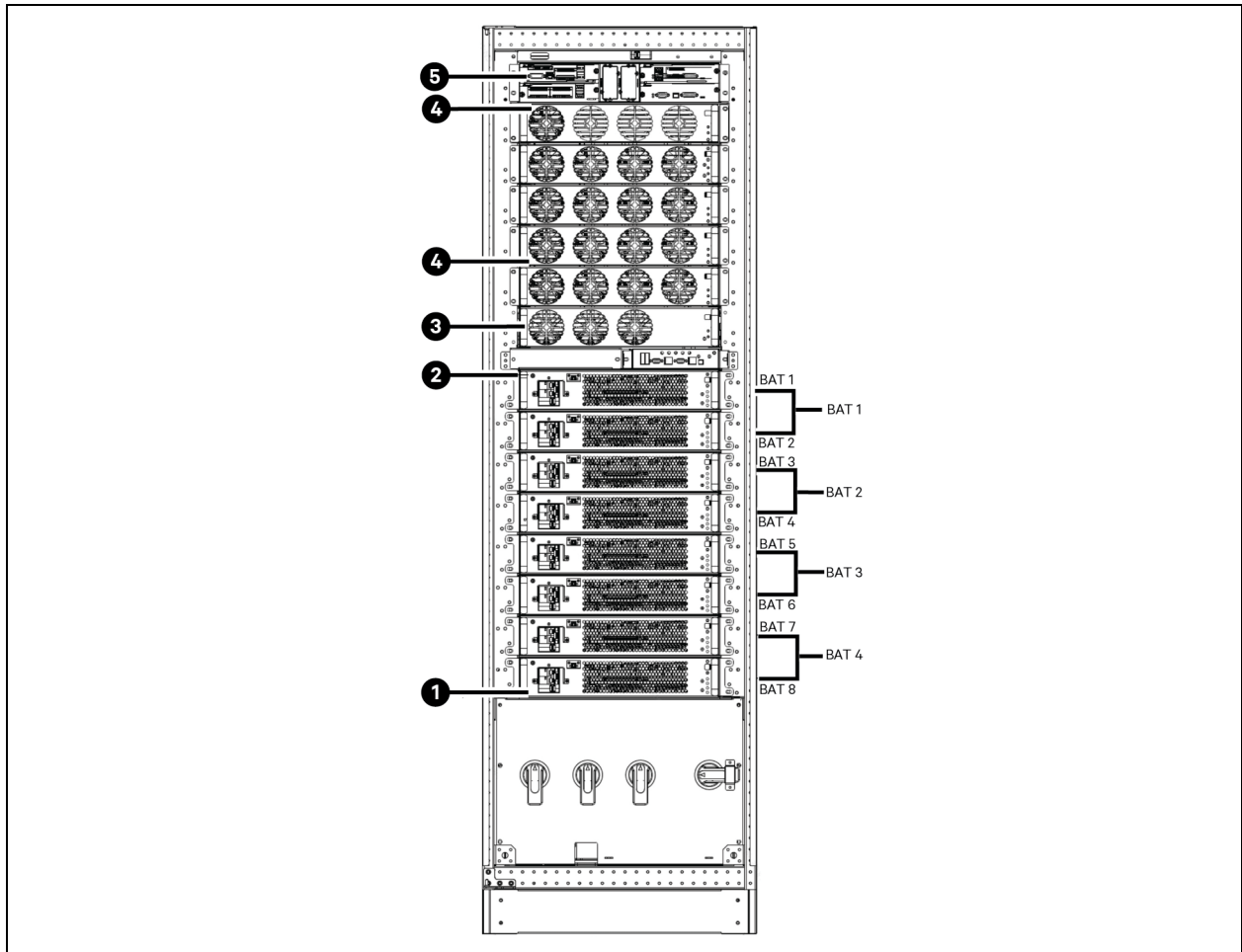

Item	Description
1	Battery
2	Battery module
3	Bypass module
4	Power module
5	Controller

Figure 2.2 Vertiv™ Liebert® APM2 Lithium Battery Module Structure (120 kVA 480 V and 60 kVA 208 V)

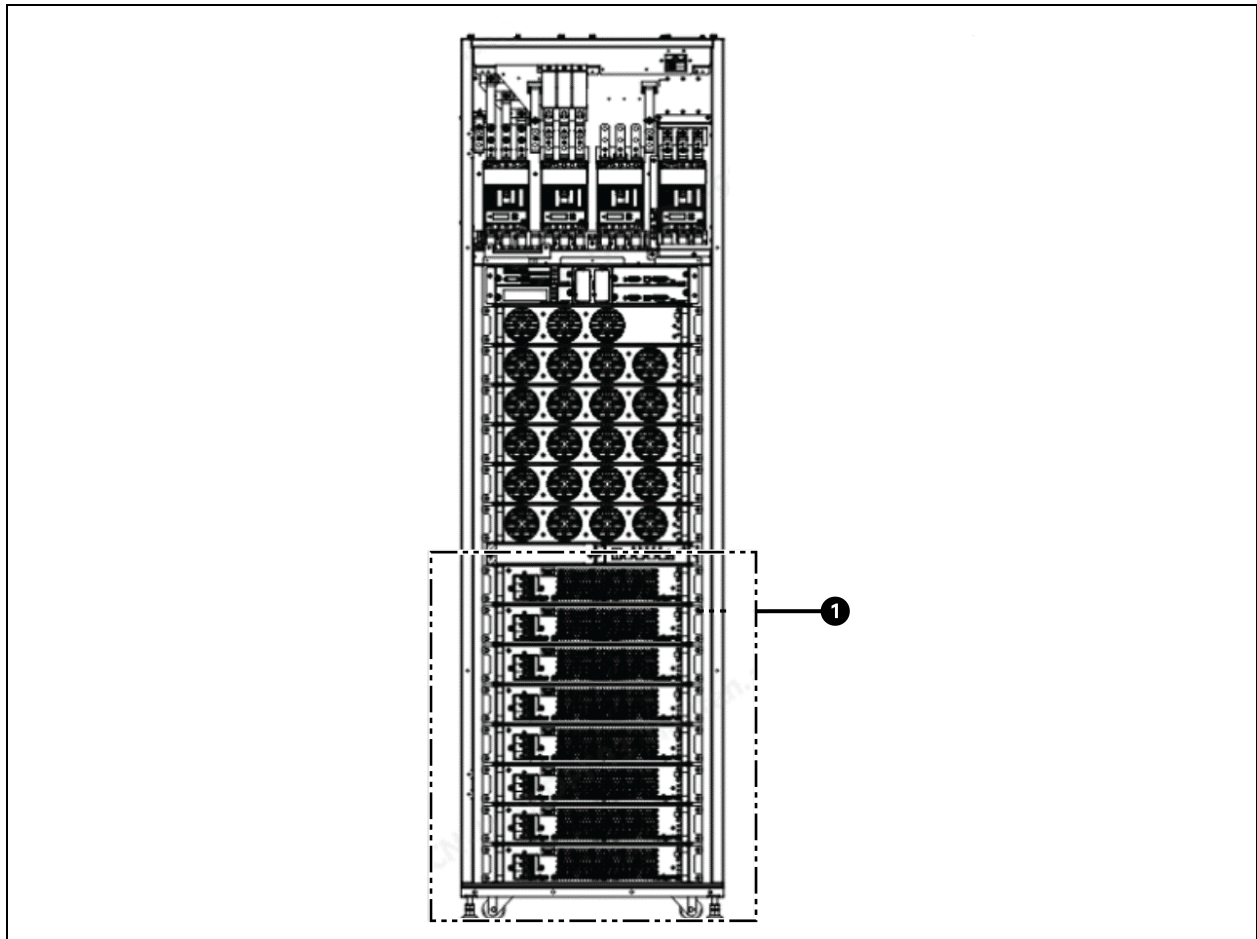

Item	Description
1	Lithium battery eight in total

2.3 Module Appearance

This chapter describes the structure of the Liebert® APM2 lithium battery module and its components.

Figure 2.3 Vertiv™ Liebert® APM2 Lithium Battery Modules

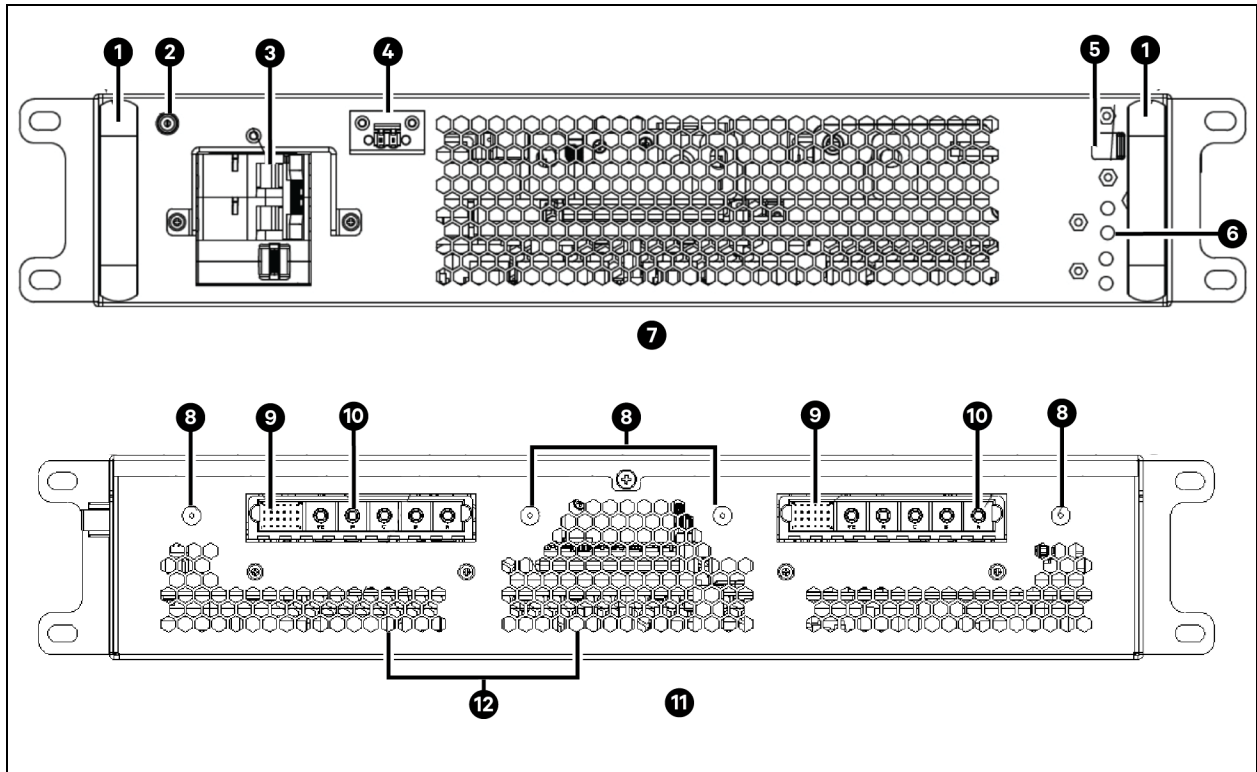

Item	Description	Item	Description
1	Handle	7	Front Panel of Liebert® APM2 lithium battery module
2	12 V external input interface	8	Retaining pin
3	MCB low voltage control switch	9	Communication cable wiring ports
4	RS-485 communication interface	10	Power cable wiring port
5	Lock switch	11	Rear Panel of Liebert® APM2 lithium battery module
6	Status indicator	12	Heat sink

Figure 2.4 Lock Switch

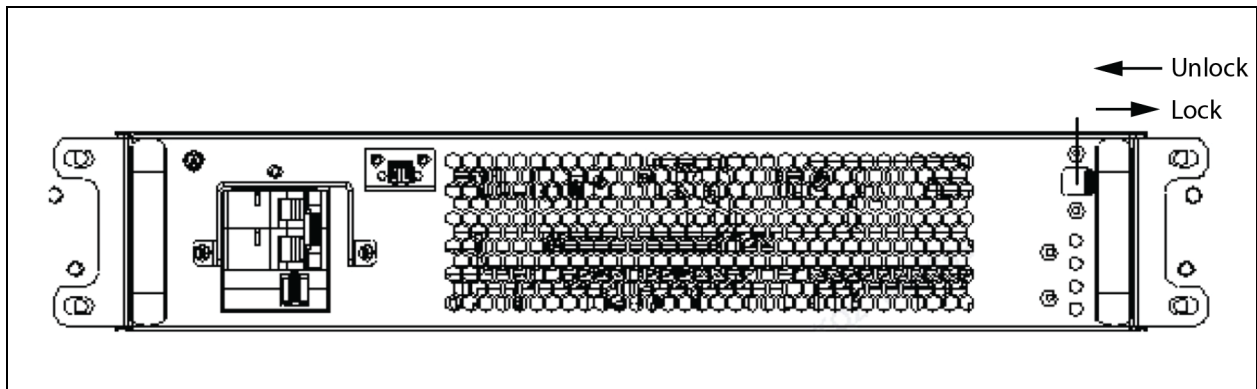

2.4 Working Principle

The Vertiv™ Liebert® APM2 lithium battery modules, along with UPS equipment, provide uninterruptible power supplies for communications, and data processing equipment, as a backup energy storage system for critical equipment.

2.4.1 Modular design

The electrical principles of the Liebert® APM2 lithium module system described in this section. The Liebert® APM2 lithium battery module is internally designed with two protections, which are DC contactors and fuses, and the electrical schematic diagram of the Liebert® APM2 lithium battery module is shown in **Figure 2.5** below.

Figure 2.5 Liebert® APM2 Lithium Battery Module System Schematic Diagram

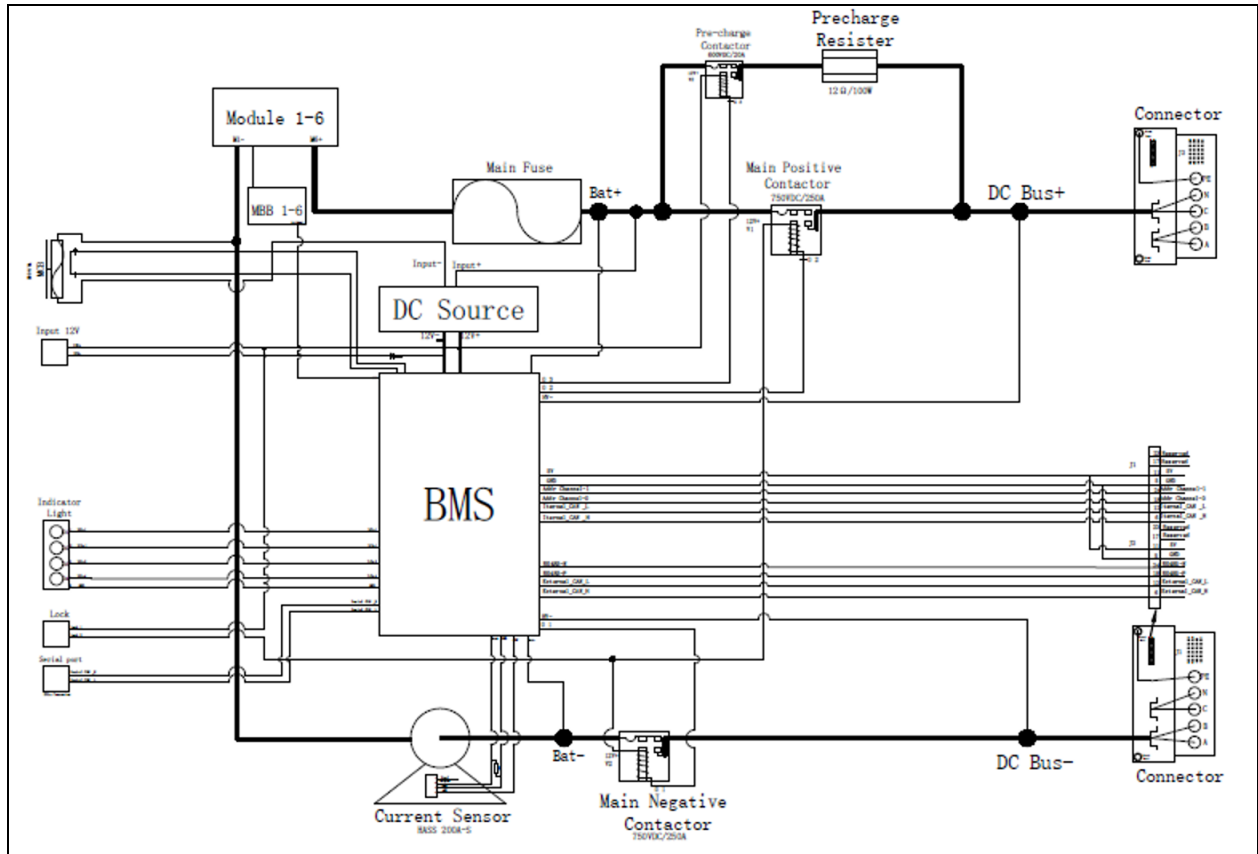

Table 2.2 Component Description of Liebert® APM2 Lithium Battery Module System

Component	Description	Component	Description
Module 1-6	Battery module	Serial port	RS-485 serial port
MCB	Miniature circuit breaker	Main fuse	Main fuse
Input 12 V	External 12 V input	DC source	DC auxiliary power supply
Indicator light	Light panel	BMS	Battery management system control board
Connector	High and low voltage connectors	Negative contactor	Main negative contactor

Table 2.2 Component Description of Liebert® APM2 Lithium Battery Module System (continued)

Component	Description	Component	Description
Current sensor	Hall DC sensors	Positive contactor	Main positive contactor
Pre-charge contactor	Pre-charge contactor	MBB 1-6	Module acquisition equalization board
Pre-charge resistor	Pre-charge resistance		

2.4.2 Module status

Resting state

The Vertiv™ Liebert® APM2 lithium battery module system is in a non-charging and non-discharging state, the BMS is active and the main circuit is ON.

Charging state

When the Liebert® APM2 lithium battery module is in the charging state, the UPS is allowed to charge the battery cluster. The charging current is sent by the lithium battery module, and the UPS controls the charger to output the current. When the battery cluster cell voltage reaches 4.18 V or the total battery voltage reaches 550 V, the charging stops, and the system still has the capability of zero delay discharge.

Discharging state

The Liebert® APM2 lithium battery module discharges to the UPS. The discharge stops when the UPS system's end-of-discharge (EOD) condition is triggered due to either low battery voltage or high battery temperature.

Dormant state

When the battery power is extremely low, the battery enters a dormant state, and the system automatically shutdown the main circuit and the BMS power supply circuit to avoid further depletion of battery power.

Fault state

If the Liebert® APM2 lithium battery module displays a fault message that cannot be eliminated automatically, contact local Vertiv customer service center for additional technical support.

2.5 Introduction of Liebert® APM2 Lithium Battery Module

This chapter provides an introductory description of the key components of the Liebert® APM2 lithium battery module.

2.5.1 Battery module

The Liebert® APM2 lithium battery module consists of six ternary lithium battery modules with a rated voltage of 39.6 V (3.6 V/CELL) in series, each module contains eleven battery cells, and each battery cell is formed by five ternary lithium cells in parallel.

Figure 2.6 Structure Diagram of Vertiv™ Liebert® APM2 Lithium Battery Module

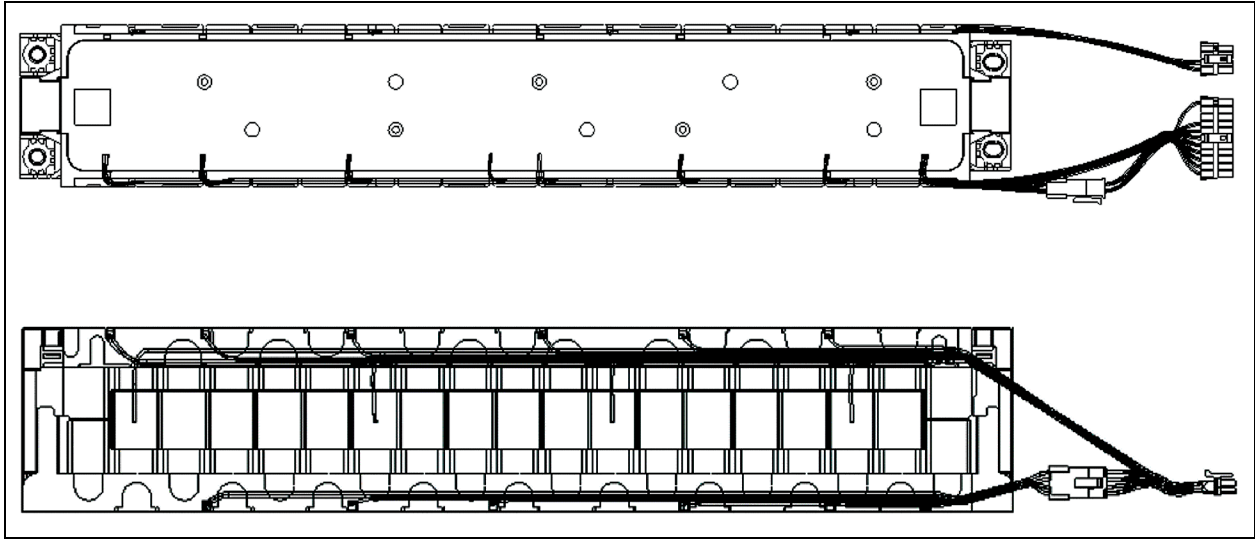

2.5.2 Electrical control components

The key components of the electrical control of the Liebert® APM2 lithium battery module are specified as below:

- **MCB:** It is the MCB of the low voltage battery power supply system with the breaking capacity of 6 A, 440 VDC. It is used as the switch to supply power to the low voltage system of the lithium battery module. When the battery needs to be powered on after being placed into the cabinet, close the MCB first to keep the low voltage system powered on.
- **Main contactor:** For lithium module ON and OFF active control.
- **Fuse:** Passive protection device, the fuse supports the lithium battery module when the external short circuit occurs fast fuse, to protect the main circuit battery or device, to prevent dangerous events.
- **Lock switch:** Used for lithium battery module into the cabinet detection, control of the main circuit contactor unilateral control and system contactor disconnection and lithium module cold start applications.

This page intentionally left blank

3 Installation Instructions

This chapter briefly describes the mechanical installation of the Vertiv™ Liebert® APM2 lithium battery module, including precautions, initial inspection, environmental requirements, and mechanical installation.

3.1 Prerequisites

The Liebert® APM2 lithium battery module must work with the Vertiv™ Liebert® APM2 120 kVA UPS. The UPS must meet the operating environment requirements of the lithium battery module. Because each site has its particularity, this section provides installation personnel with general installation procedures and methods, which are handled according to the specific site conditions.

IMPORTANT! Do not unpack until a Vertiv authorized service engineer arrives.

IMPORTANT! Installation of the module should be carried out by a service engineer according to the instructions in this section.



WARNING! Risk of high battery voltage. Can cause personal injury or death. When the battery is connected, the voltage at the battery terminals may exceed 400 VDC hazardous voltage.



AVERTISSEMENT! Risque de tension élevée de la batterie. Peut provoquer des blessures ou la mort. Lorsque la batterie est connectée, la tension aux bornes de la batterie peut dépasser la tension dangereuse de 400 VCC.

- Wear eye protection to avoid accidental arc damage to the eyes.
- Remove rings, watches, and all other metal wearables.
- Use tools with insulated handles and wear rubber gloves.
- If the battery electrolyte leaks or the battery is damaged, this battery module must be replaced and scrapped according to local regulations.
- If skin contact with the electrolyte occurs, rinse immediately with water.
- Module short-circuiting and battery collision are strictly prohibited.
- Modules are strictly prohibited to be close to high temperature heat sources, and are strictly prohibited to be close to water sources.

3.2 Preparation for Installation

3.2.1 Tools























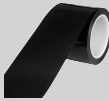

WARNING! Risk of electric shock and hazardous voltage. Can cause personal injury or death. The Installation tools under live operation must be insulated. The tools listed in **Table 3.1 on the next page are for reference only. For onsite installation and connection, use the actual required tools.**



AVERTISSEMENT! Risque d'électrocution et de tension dangereuse. Peut provoquer des blessures ou la mort. Les outils d'installation sous tension doivent être isolés. Les outils énumérés dans le **Table 3.1 below de la page suivante ne sont donnés qu'à titre de référence. Pour l'installation et la connexion sur site, utilisez les outils réellement nécessaires.**

Table 3.1 Tools

Name	Drawing	Name	Drawing
Electric hand drill		Adjustable wrench	
Slotted screwdriver		Cross head screwdriver	
Stepladder		Forklift	
Drill		Wire cutting plier	
Claw hammer		Diagonal cutting plier	
Insulating shoes		Antistatic gloves	
Electrician knife		Cable tie	
Insulating tape		Insulating gloves	
Crimping plier		Heat shrinkable tube	
Insulated torque wrench		Torque screwdriver	
Multimeter		Clip-on ammeter	

3.2.2 Confirmation of UPS installation environment

Before installing the Vertiv™ Liebert® APM2 lithium battery module, make sure that the supporting UPS is in place and that the operating environment meets the following conditions:

1. It should be installed in a cool, dry, clean and well-ventilated indoor environment with constant temperature and humidity. It should be installed on concrete or other non-flammable and flat mounting surface. Environmental dust cannot contain conductive dust (such as metal powder, sulfide, sulfur dioxide, graphite, carbon fiber, conductive fiber, and so on), acid fog or other conductive media (strong ionizing substances). The specific environmental indicators must meet the requirements of relevant national standards and specifications and within the range of indicators specified in this manual. Refer **Table 6.2** on page 39.
2. Keep a distance of at least 500 mm between the back of the UPS and the wall. This prevents the ventilation and heat dissipation of the UPS and increases the internal temperature of the cabinet. If necessary, install an indoor exhaust fan to prevent the room temperature from increasing excessively. Keep the UPS cabinet away from the heat source and air conditioner outlet.
3. In a dusty environment, install an air filter on the vent of the equipment room. At the same time, replace the air filter or clean the dust on the air filter to avoid affecting the heat dissipation efficiency of the UPS.
4. If there is no need to install the lithium battery module immediately, it must be stored in a dry, cool, and well-ventilated place using the original packaging from Vertiv, with the optimal storage temperature being 20°C to 25°C.

NOTE: The indoor environment where the Vertiv™ Liebert® APM2 lithium battery module is installed must be equipped with constant temperature and humidity precision air conditioners.

NOTE: The ambient temperature of the lithium battery module should be kept constant. Ambient temperature is the main factor affecting battery capacity and life. The optimum operating temperature of a battery ranges from 15°C to 30°C. Operating at a temperature higher than this threshold shortens the battery life. Operating at a temperature lower than this threshold shortens the battery backup time.



WARNING! During battery storage, periodically charge the battery according to the battery manufacturer instructions. In the charging process, temporarily connect the UPS to the mains and activate the battery by recharging the battery.



AVERTISSEMENT! Pendant le stockage de la batterie, chargez périodiquement la batterie conformément aux instructions du fabricant de la batterie. Au cours du processus de charge, connectez temporairement l'onduleur au secteur et activez la batterie en la rechargeant.

3.3 Handling and Unpacking

3.3.1 Carrying lithium battery modules

IMPORTANT! The lithium battery modules must be handled by trained professionals.

IMPORTANT! The lithium battery module must be handled with care to avoid collision and falling.

IMPORTANT! Lifting equipment used for handling lithium batteries must have sufficient lifting capacity.

The lithium battery module is packed in a wooden case. Use an electric forklift or a manual forklift to move the lithium battery module. Make sure that the center of gravity of the lithium battery module is in the center of the fork of the moving device.

When moving the forklift, make sure that the end of the forklift exceeds the module packing tray to avoid damage to the lithium battery module package due to force.

It is recommended not to move more than four layers at the same time. Do not lift the lithium battery module too high when using an electric forklift.

NOTE: Lithium modules are packaged independently during transportation, and must be kept upright and upward during transportation and handling, and must not be tipped over for transportation or handling.

3.3.2 Unpacking

NOTE: Before removing the packaging, visually inspect the packaging for damage. If there is any abnormality, contact the local customer service center of Vertiv immediately for assistance.

Unpack the battery under the guidance of a Vertiv authorized service engineer as follows:

1. Use an electric forklift to carry the lithium battery module boxes to the installed UPS rack.
2. Cut off the packing tape. Cut off the packing tape with pliers, remove the plastic film, open all the locks on the battery box, and remove the wooden upper cover. Remove the upper fastening foam, disassemble the plastic bag wrapping the lithium module, and take out the lithium battery module, as shown in **Figure 3.1** below.

Figure 3.1 Removing Packing Strips and Wooden Top Cover Plates

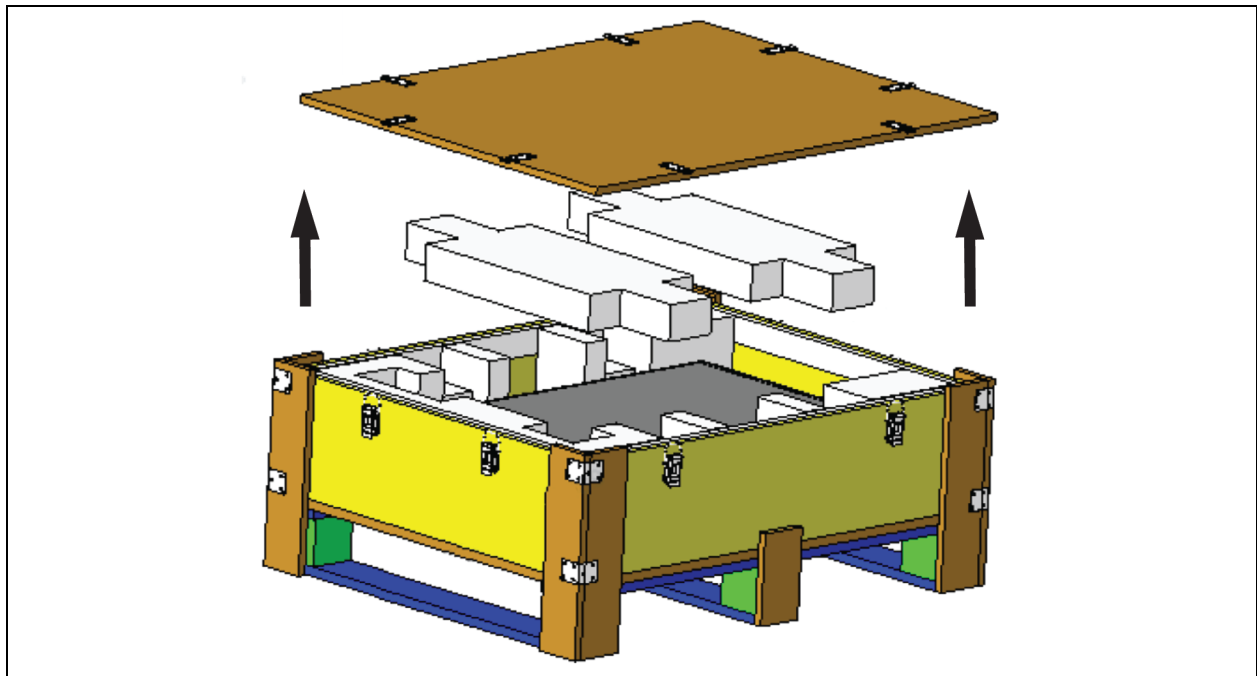

3. Unwrap the adhesive bag wrapping the lithium battery module and remove the lithium battery module.

NOTE: The weight of lithium module is more than 35 kg, when user take out the module from the packing box, use lifting tools or more than two people to carry it, and avoid collision and fall during the carrying process.

NOTE: After removing the lithium module, make sure that the air switch is in the OFF position and the lock switch is turned to unlock.

4. Place the lithium battery module onto the auxiliary lifting device. If no similar device is available, it is recommended that this step be performed when the module needs to be mounted to the rack.

3.3.3 Re-check before installation

Before installing the lithium battery module, performed the following checks :

1. Make sure that the environment of the machine room meets the environmental requirements specified in the [Product Specification](#) on page 39, in particular the ambient temperature, ventilation conditions and dust conditions.
2. Make sure that the supporting UPS rack is installed correctly.
3. Check the product label to confirm the correctness of the equipment. The device name plate is affixed to the case cover of the lithium battery module, indicating the battery model, voltage, capacity, and other parameters. If the device model does not match, contact the Vertiv customer service center.

3.4 Lithium Battery Module Installation

Vertiv™ Liebert® APM2 lithium battery modules are all packaged in a single, independent package, and the lithium battery modules all need to be installed onsite.

1. Remove the dummy panel on the cabinet that corresponds to the location of the lithium battery module.
2. Remove the lithium battery module from the box or operate the auxiliary lifting platform to align the mounting position.
3. Working from the bottom to the top, insert the lithium battery module into the UPS cabinet and lock the module in place using the screws included in the accessories once the module is in place.

NOTE: When installing the lithium battery module, pay attention to the snap in the middle of the body and do not use excessive force to avoid damaging the rear of the module and the connector on the cabinet.

NOTE: When installing the upper lithium battery module, it is recommended to use a lifting tool.

NOTE: Dummy panels are retained in locations where lithium battery modules are not installed when the lithium battery modules are not fully loaded.

NOTE: Once the module is installed, do not close the air switch and toggle the lock switch until power ON is confirmed.

4. After the lithium battery module is inserted into the rack, the power output and communication of the lithium battery module are connected to the rack without additional cables.
5. When removing the installed module, ensure that the circuit breaker is OFF, and the lock switch is in the unlocking position then take out the screws and pull out the module slowly through the module handle. If half of the module has been taken out is displayed, half of the module has been taken out. In this case, two people need to work together to lift the module out. Do not operate the module by one person to avoid falling after the module is pulled out.

This page intentionally left blank

4 Startup, Operation, and Commissioning

This chapter describes the process and operation of powering ON and OFF the Vertiv™ Liebert® APM2 lithium battery module.

4.1 Notes

NOTE: Operate the UPS only after it is commissioned and started by the Vertiv authorized engineer.

NOTE: Wear proper personal protective equipment (PPE) when powering on a lithium battery module for the first time.

IMPORTANT! Before installing the lithium battery module into the cabinet, make sure that the lithium battery module cannot be mixed with other types of battery modules such as lead-acid modules.



WARNING! Hazardous mains and/or battery voltage:

Do not open and the components behind the UPS inner door. Only qualified maintenance personnel are allowed to open the inner door of the UPS, with maintenance tools.

At any time, the DC input and output terminals of the Liebert® APM2 lithium battery module can have dangerous voltages.



AVERTISSEMENT! Tension secteur et/ou batterie dangereuse :

Ne pas ouvrir et les composants situés derrière la porte intérieure de l'ASI. Seul le personnel d'entretien qualifié est d'entretien qualifié est autorisé à ouvrir la porte intérieure de l'onduleur avec des outils d'entretien.

Les bornes d'entrée et de sortie CC du module de batterie au lithium Liebert® APM2 peuvent à tout moment présenter des tensions dangereuses.

- All operations and touchscreen display referred in the operating procedures are described in the user's manual of the UPS and in [Operation Control Display Panel](#) on page 27.
- During operation, the buzzer alarm may appear at any time, the sound alarm can be eliminated on the touchscreen but cannot eliminate the alarm state.
- Before carrying out commissioning of lithium module startup, the supporting UPS should be tested individually to ensure that the UPS is working properly, and the load is within the appropriate range so as not to cause battery overload protection.
- Make sure that the number of batteries is matched to the load of the matching UPS application.
- Make sure that the lithium battery module blank is disconnected, and the lock switch is in the unlocked state.

4.2 Powering ON and OFF

4.2.1 Power-on

This operation will electrically charge the output terminals of the lithium module, so the operator must wear the personal protection equipments before powering ON the lithium module.

IMPORTANT! Vertiv service engineer must power ON the lithium-ion module and confirm that the module is working normal before transferring to the user for operation.

Whether UPS is online or not online, we can all insert the battery module into the UPS system, the operation after inserting the UPS cabinet is as follows:

1. Close the circuit breaker of the lithium battery module and turn the lock switch to the locked state.
2. After the lithium battery module is powered ON, wait about 1 minute. After the contactor inside the module is plugged in, the module is powered ON.

4.2.2 Power-off



CAUTION: This operation may affect the load power supply when the UPS battery is operating in discharge mode.



ATTENTION: Cette opération peut affecter l'alimentation de la charge lorsque la batterie de l'ASI fonctionne en mode décharge.

Whether UPS is online or not online, we can make changes to the battery module, such as unplugging the module from the UPS rack, as follows:

1. When the lithium battery system needs to be powered OFF.
2. Disconnect the circuit breaker of the lithium battery module.
3. To pull out the lithium battery module, turn the lock switch to the unlocked state, and then refer to [Lithium Battery Module Installation](#) on page 17 for operation.

4.2.3 Emergency power-off

When the lithium battery module is operating in normal state, user can turn the lock switch to the unlocked state, which will make the lithium battery module disconnect from the power supply. User can also disconnect the battery by pressing the emergency shutdown *EPO* button of the UPS. For details, refer the SL-71058 Vertiv™ Liebert® APM2 300 to 600 kVA Modular UPS User Manual and SL-71076 Vertiv™ Liebert® APM2 30 to 120 kVA Modular UPS User Manual.

The UPS EPO is used to shutdown the entire system, to cut off the load power supply (including inverter and bypass output) and stop charging or discharging batteries in emergency situations (such as fire or flood). To shutdown the only lithium battery module, refer [Powering ON and OFF](#) on the previous page for specific operations.

4.3 UPS Power-ON Test



CAUTION: Do not press the battery cold start button before the battery high voltage indicator is illuminated.



ATTENTION: N'appuyez pas sur le bouton de démarrage à froid de la batterie avant que l'indicateur de haute tension de la batterie ne soit allumé.



CAUTION: This procedure will energize the UPS output terminals. If there is a load connected to the UPS output terminals, verify with the user that it is safe to supply power to the load. If the load is not ready to receive power, disconnect the load connection switch and place a warning label on the switch.



ATTENTION: Cette procédure met sous tension les bornes de sortie de l'onduleur. Si une charge est connectée aux bornes de sortie de l'onduleur, vérifiez avec l'utilisateur que la charge peut être alimentée en toute sécurité. Si la charge n'est pas prête à être alimentée, déconnectez l'interrupteur de connexion de la charge et placez une étiquette d'avertissement sur l'interrupteur.

1. Turn on the lock switch and circuit breaker on the lithium battery module. The BMS status indicator turns ON. Wait about 1 minute for the lithium battery module to get completely powered on. In this case, user can turn on the external mains input switch of the UPS and start the UPS. User can also turn on the UPS in battery mode by cold starting the battery. (For details about UPS operations, refer the SL-71058 Vertiv™ Liebert® APM2 300 to 600 kVA Modular UPS User Manual and SL-71076 Vertiv™ Liebert® APM2 30 to 120 kVA Modular UPS User Manual.).
2. After the UPS is started, ensure that the UPS output is normal, and the output voltage and frequency meet the preset values. Close the load switch to supply power to loads. Check the battery SOC, charge and discharge current, temperature, and backup time on the UPS screen.
3. After the UPS starts, turn off the mains input switch and switch the UPS to battery mode. Battery mode When the power is ON, turn on the UPS input switch. The UPS switches from battery mode to mains power supply. At the same time, the lithium battery module switches from discharge to charge.

4.4 Commissioning Record List

The commissioning record is given in the **Table 4.1** below for user reference.

Table 4.1 Reference Commissioning Record List

Form	Test Items	Inspection Standards	Result	Test Items	Inspection Standards	Result
Battery module	Battery module indicators	Normal		Display status	Each item shows compliance with requirements.	
Control section	Display operating conditions	No scrolling, messy screen		Battery information display	Normal display	
	System parameters	Setting is correct				
	Time display	Timing is correct.		Address settings	The address is correct.	
	Contactors status	Closed and normal		Battery charge and discharge	Current discharge is negative, charge is positive, charge/discharge state is correct.	
	AC start	AC start normal		DC start	DC start normal	
	Temperature and humidity display	Data is normal and recorded		Environmental humidity	Data is normal and recorded	
Cluster voltage difference	Module 1 total voltage	Pressure difference with other modules less than 10 V.		Module 5 total voltage	Pressure difference with other modules less than 10 V.	
	Module 2 total voltage	Pressure difference with other modules less than 10 V.		Module 6 total voltage	Pressure difference with other modules less than 10 V.	
	Module 3 total voltage	Pressure difference with other modules less than 10 V.		Module 7 total voltage	Pressure difference with other modules less than 10 V.	
	Module 4 total voltage	Pressure difference with other modules less than 10 V.		Module 8 total voltage	Pressure difference with other modules less than 10 V.	
Battery parameter logging	Maximum cell voltage	Record		Maximum cell voltage	Record	
	Maximum cell temperature	Record		Maximum cell temperature	Record	

4.5 Lithium Battery Module Paramset Set Up

Before entering the cabinet for the first time and powering on the lithium battery module, set and confirm the following parameters by the local Vertiv technical support engineers.

1. Open ParamSet Settings software on the PC, and select Battery Parameter as shown below.

ParamSet for APM2 #1: Connected, 2/5

System | System Control Card | Bypass Module | Power Module | Battery

System

ID	Signal Name	Value	Unit	ID	Signal Name	Value	Unit
0	Input Voltage Phase A	231.50	V	0	MMS Output Active Power ...	0.00	kW
1	Input Voltage Phase B	232.90	V	1	MMS Output Active Power ...	0.00	kW
2	Input Voltage Phase C	232.80	V	2	MMS Output Active Power ...	0.00	kW
3	Input Voltage Line AB	402.10	V	3	MMS Output Reactive Pow...	0.00	kvar
4	Input Voltage Line BC	403.30	V	4	MMS Output Reactive Pow...	0.00	kvar
5	Input Voltage Line CA	402.00	V	5	MMS Output Reactive Pow...	0.00	kvar
6	Input Current Phase A	0.60	A	6	MMS Output Apparent Po...	0.00	kVA
7	Input Current Phase B	0.50	A	7	MMS Output Apparent Po...	0.00	kVA
8	Input Current Phase C	0.40	A	8	MMS Output Apparent Po...	0.00	kVA
9	Input Frequency	49.94	Hz				
10	Input Power Factor Phase A	0.00		10	Ambient Temperature	27.10	°C
11	Input Power Factor Phase B	0.00					
12	Input Power Factor Phase C	0.00					
13	Input Active Power Phase A	0.00	kW				
14	Input Active Power Phase B	0.00	kW				
15	Input Active Power Phase C	0.00	kW				
16	Input Apparent Power Ph...	0.10	kVA				
17	Input Apparent Power Ph...	0.10	kVA				
18	Input Apparent Power Ph...	0.00	kVA				
19	Input Energy Phase A	N/A	kWh				
20	Input Energy Phase B	N/A	kWh				
21	Input Energy Phase C	N/A	kWh				
23	Bypass Voltage Phase A	232.00	V				

System Parameter | **Battery Parameter** | Get Fault Data

System Control Parameter | Battery Curve | Get Fault Snapshot

Bypass Parameter | Get All Data | Advanced

Rectifier Parameter | Get Event Log | About...

Inverter Parameter | Get Measures | Exit

VERTIV
10.116.52.36

2. **Setting Battery parameters:** Set the Battery Chemistry Type to 7 and Battery Cabinet Type to 3. Check information: The number of Internal Battery Module Count is 8, the number of External Battery cabinet Count is 0, the Battery Cell Count Per String is 132, the capacity of Battery Cell Nominal Ah/W is 14, the Battery Charge Current Limit is 1.1, the Battery Float Charge Voltage is 4.180, and the Battery Equalize Charge Voltage is 4.180.

Figure 4.1 Battery Parameter View 1

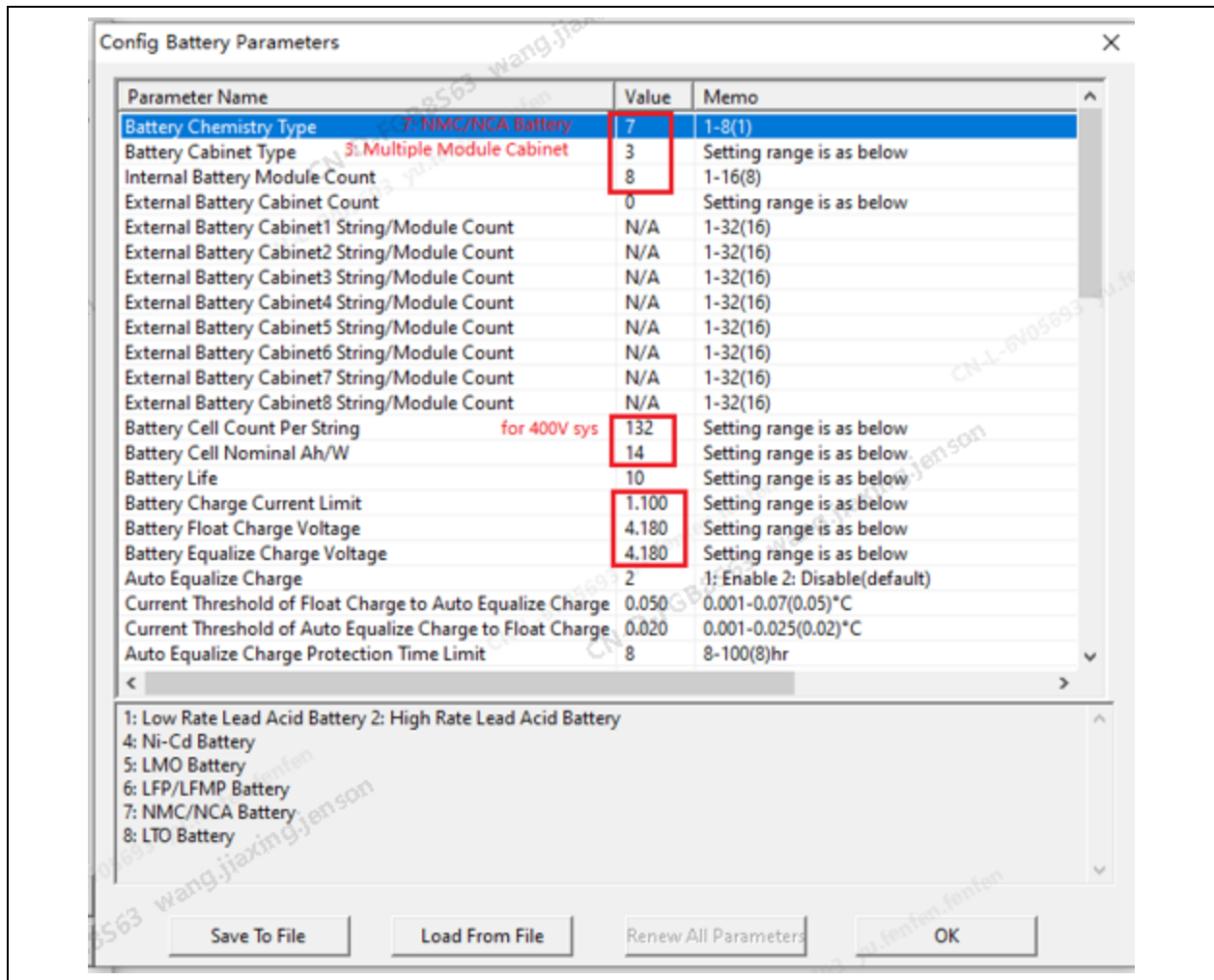

3. **Setting Battery parameters:** Set the Battery System Communication Protocol to 7. Check information: The Charger OV Fault Detection Setpoint is 4.350, the Charge Off Protection Setpoint is 4.270, the Battery EOD Lower Voltage is 2.90, and the Battery EOD Upper Voltage is 2.90.

Figure 4.2 Battery Parameter View 2

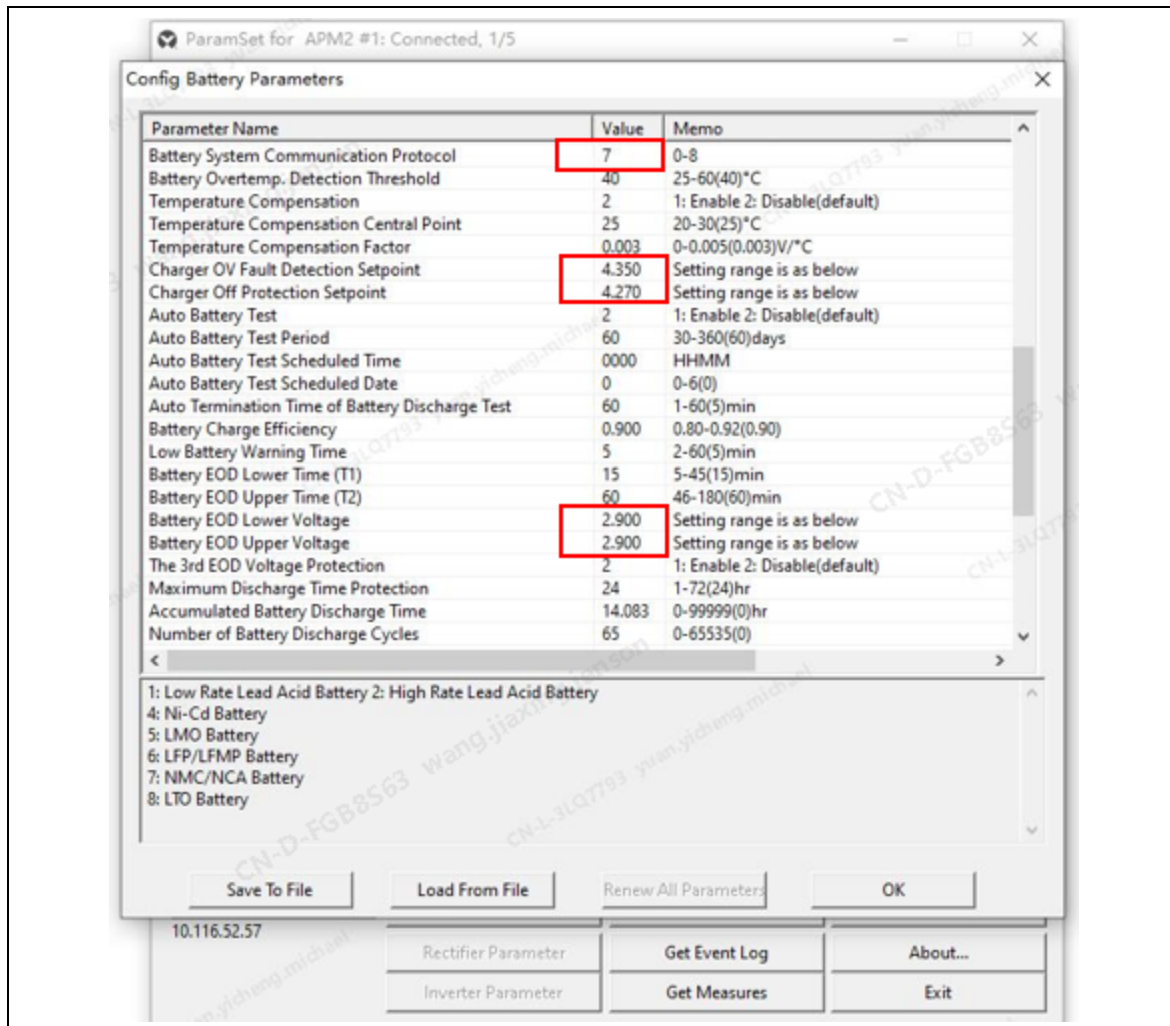

Other parameters remain unchanged by default. After setting the parameters, click on *Save To File*.

This page intentionally left blank

5 Operation Control Display Panel

5.1 Overview

Display HMI touch control panel of the Vertiv™ Liebert® APM2 lithium battery module UPS cabinet (referred to as the touchscreen), collect information about the operating status of the Liebert® APM2 lithium battery module and displays it in the form of a graph or text. The touchscreen allows user to perform operations such as switching on/off/fault resolving.

Figure 5.1 Vertiv™ Liebert® APM2 Lithium Battery Module Touchscreen

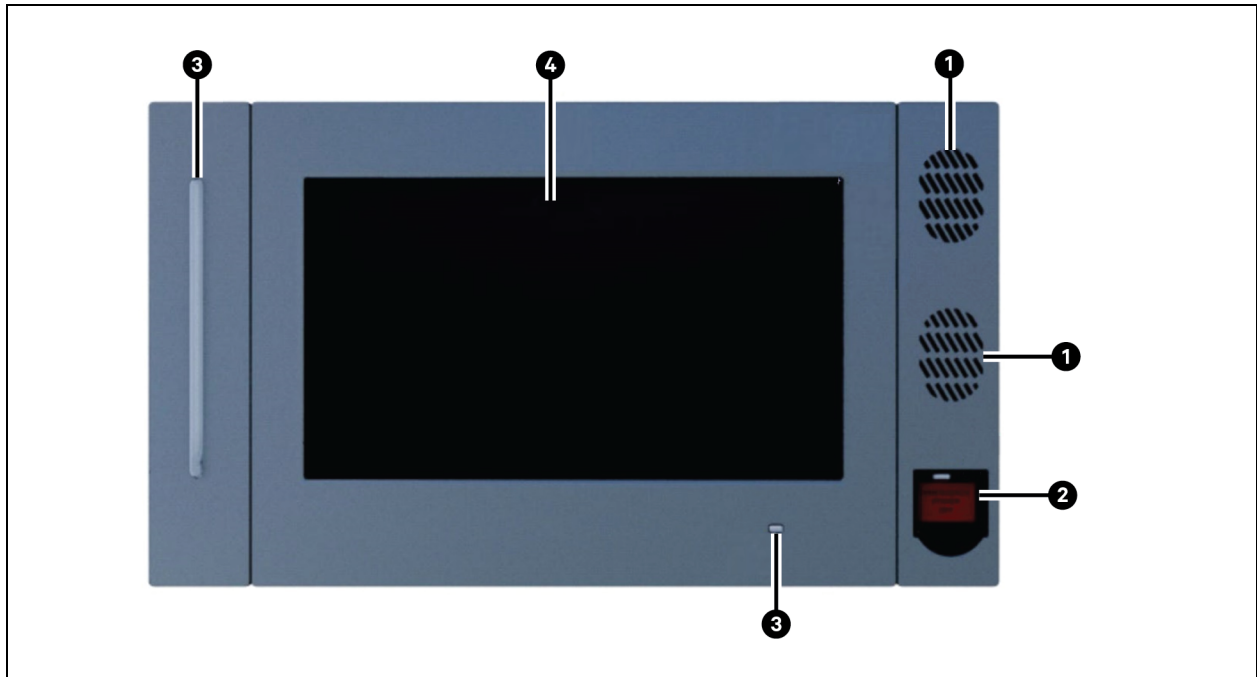

Item	Description
1	Speakers
2	EPO switch
3	UPS status LED
4	Touchscreen LCD

The main interface of the system after startup is shown below. See **Figure 5.2** below.

Figure 5.2 Home Page

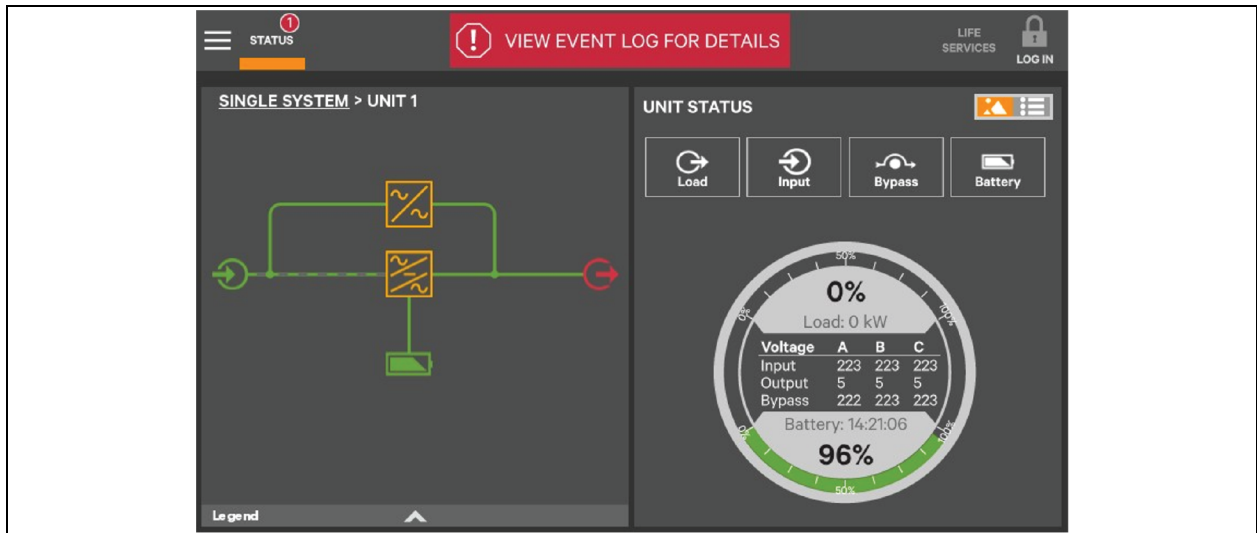

Figure 5.3 below shows the main screen of the HMI display about the lithium battery module information, click battery icon on the main screen. The specific lithium battery module information is displayed on the right side.

Figure 5.3 Main Screen Lithium Battery Module

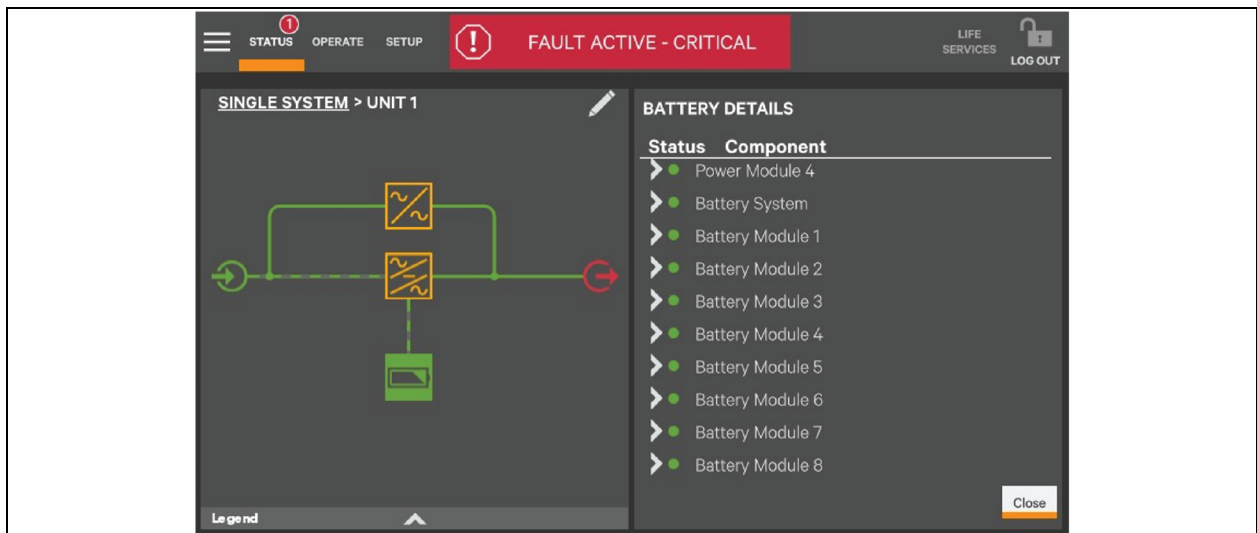

Figure 5.4 Lithium Battery Status

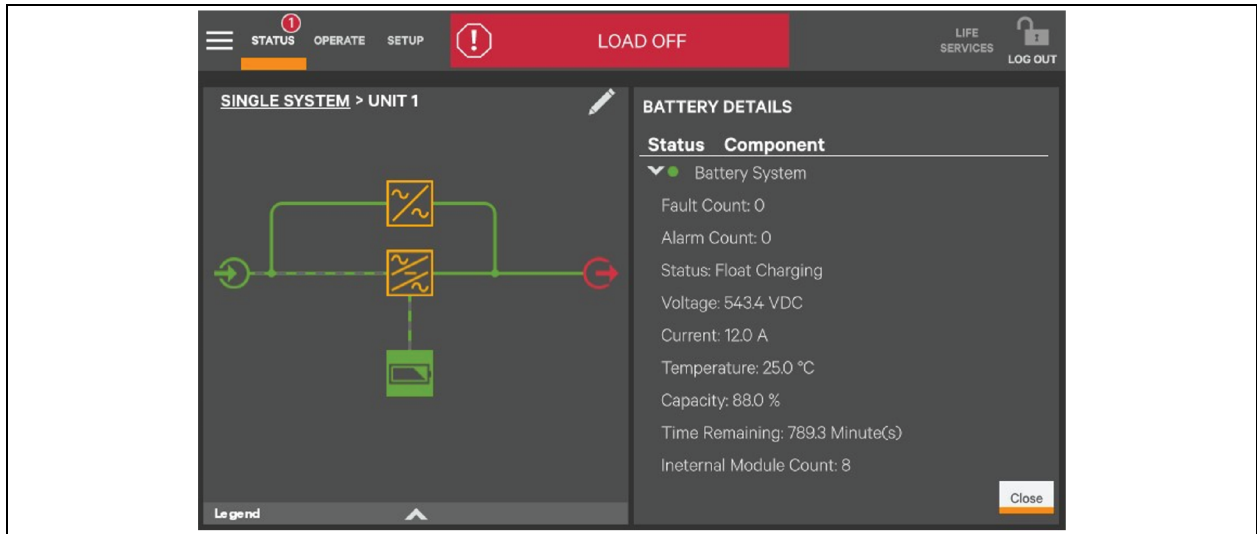

Figure 5.5 below shows the main screen of the HMI display about the lithium module information, click battery icon on the main screen. The specific lithium battery module information will be displayed on the left side.

Figure 5.5 Battery Report—Unit Status

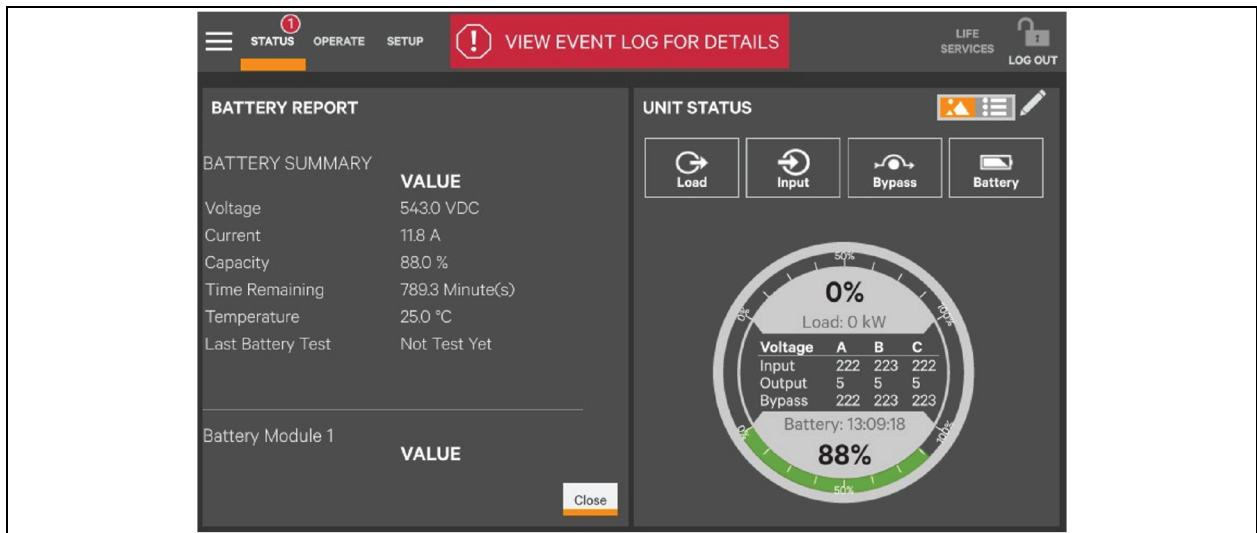

Figure 5.6 Event Log Details

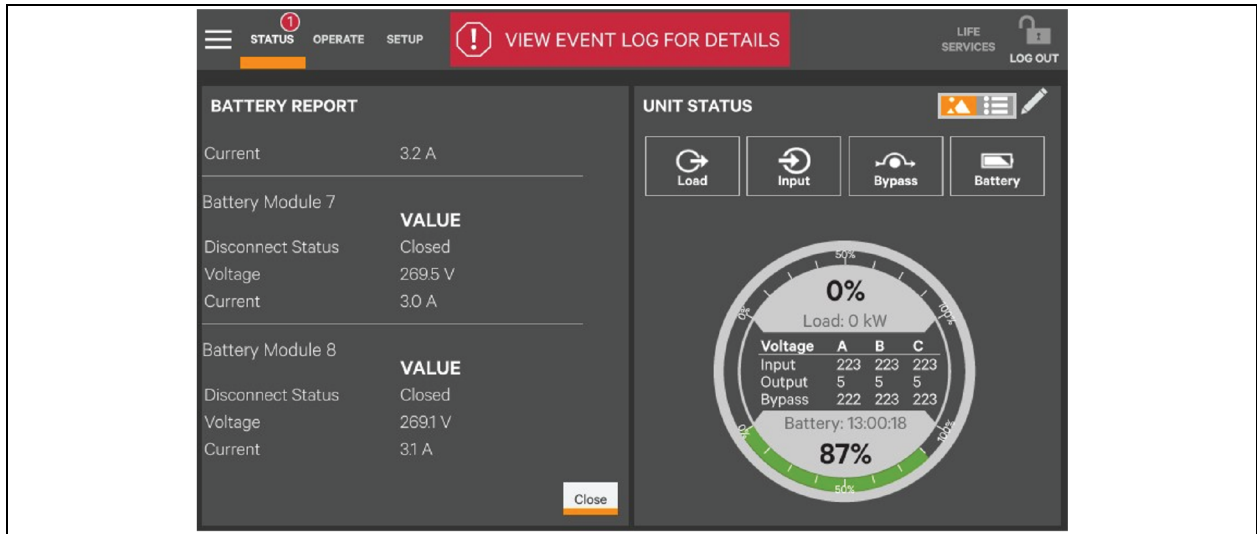

Figure 5.7 below shows the HMI display of the lithium module specific information, click on the STATUS in the upper left corner of the main screen then click on the horizontal ellipses and then click on BATTERY MONITOR.

Specific battery discharge statistics are listed below:

Figure 5.7 Battery Discharge Statistics

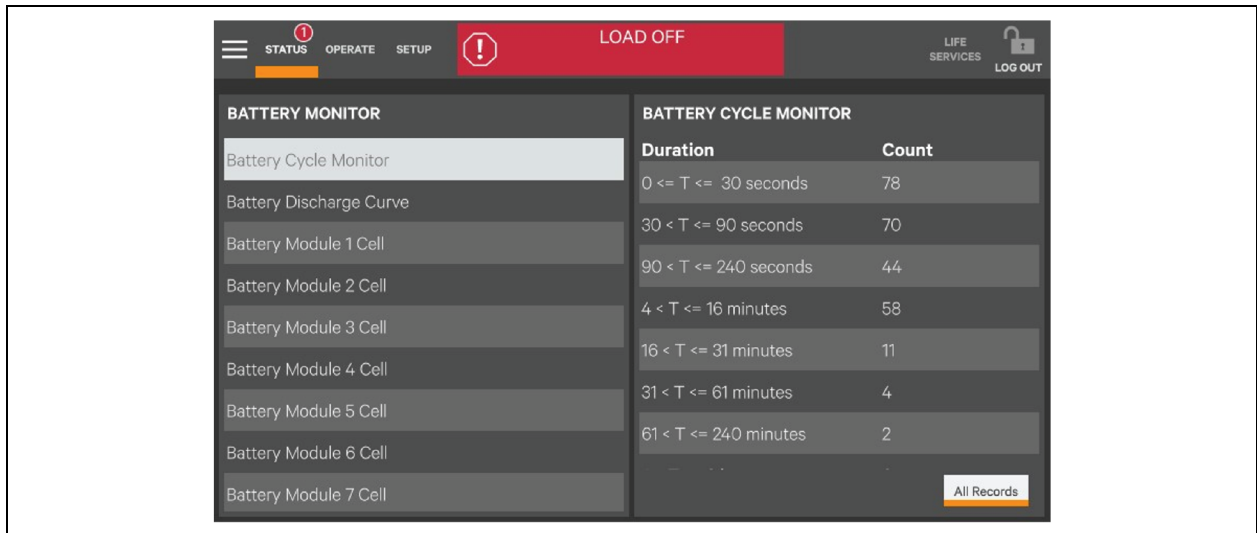

Figure 5.8 below shows the battery discharge curve displayed by the HMI as below:

Figure 5.8 Battery Discharge Curve

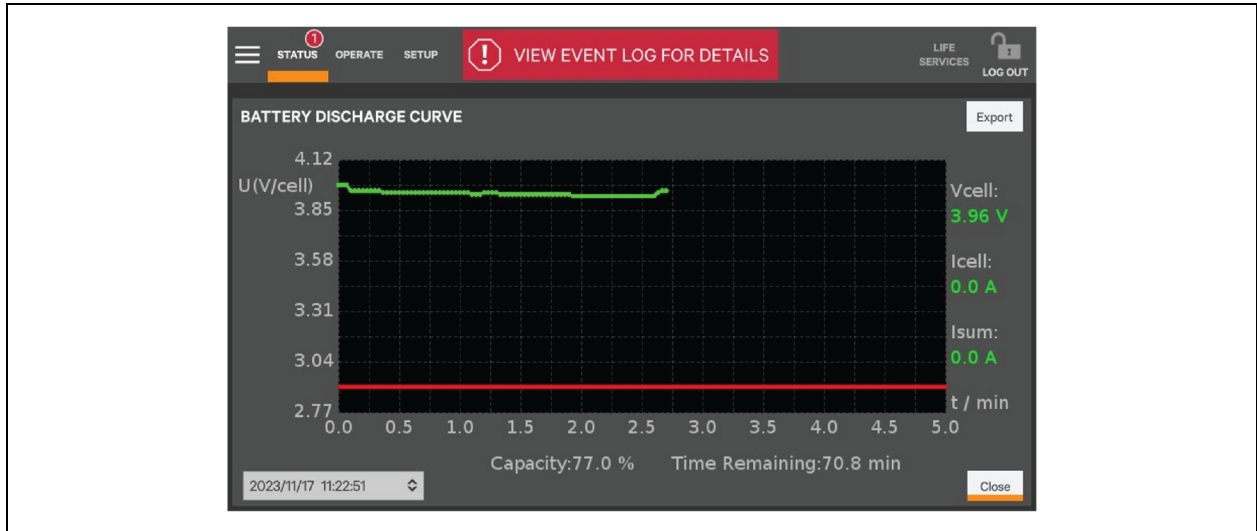

Figure 5.9 below shows the battery voltage and temperature data displayed by the HMI as below:

Figure 5.9 Battery Specific Voltage and Temperature Data

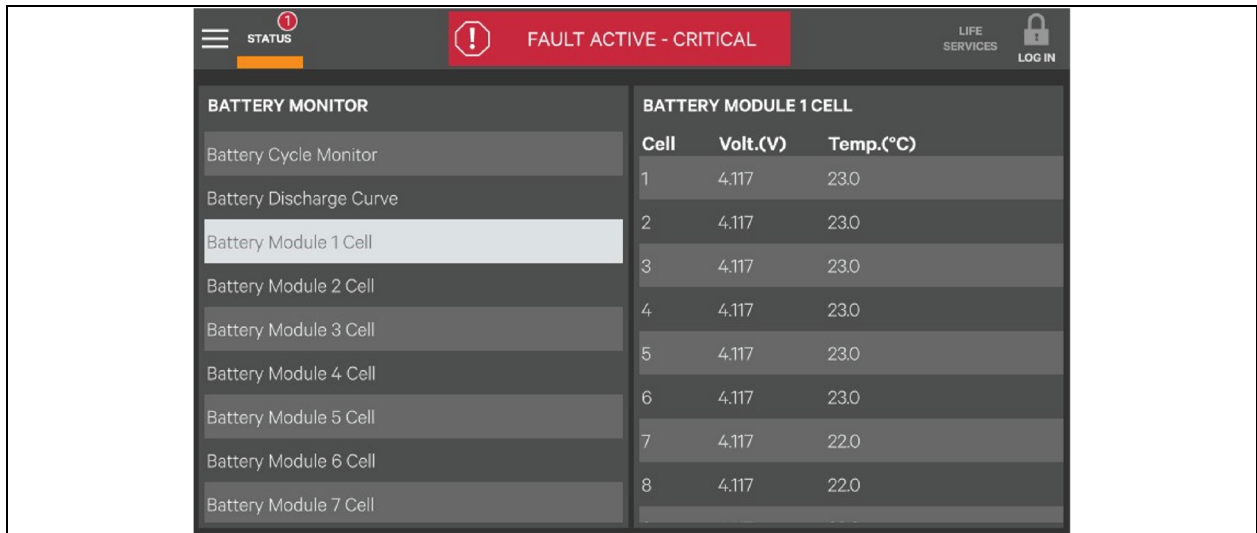

Figure 5.10 Battery Specific Voltage and Temperature Data

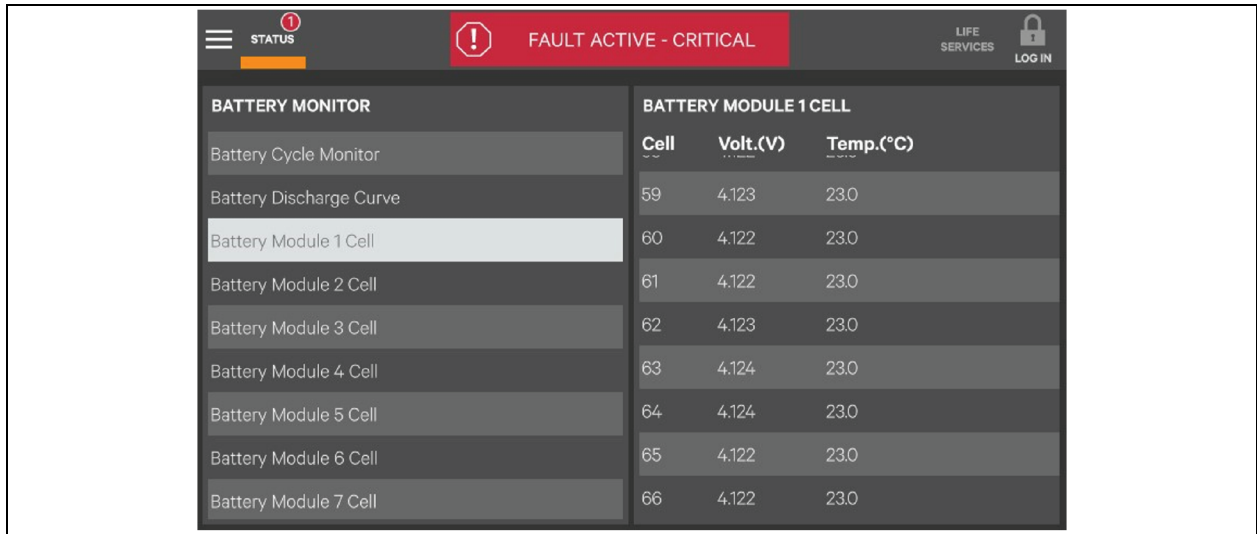

Figure 5.11 below shows the specific information of the lithium battery module of the HMI display, click on the *STATUS* in the upper left corner of the main screen then click on horizontal ellipses. Then click on *ABOUT*, to view the specific version of the battery information and the program version of module 1 to module 8.

Figure 5.11 Software Program Version

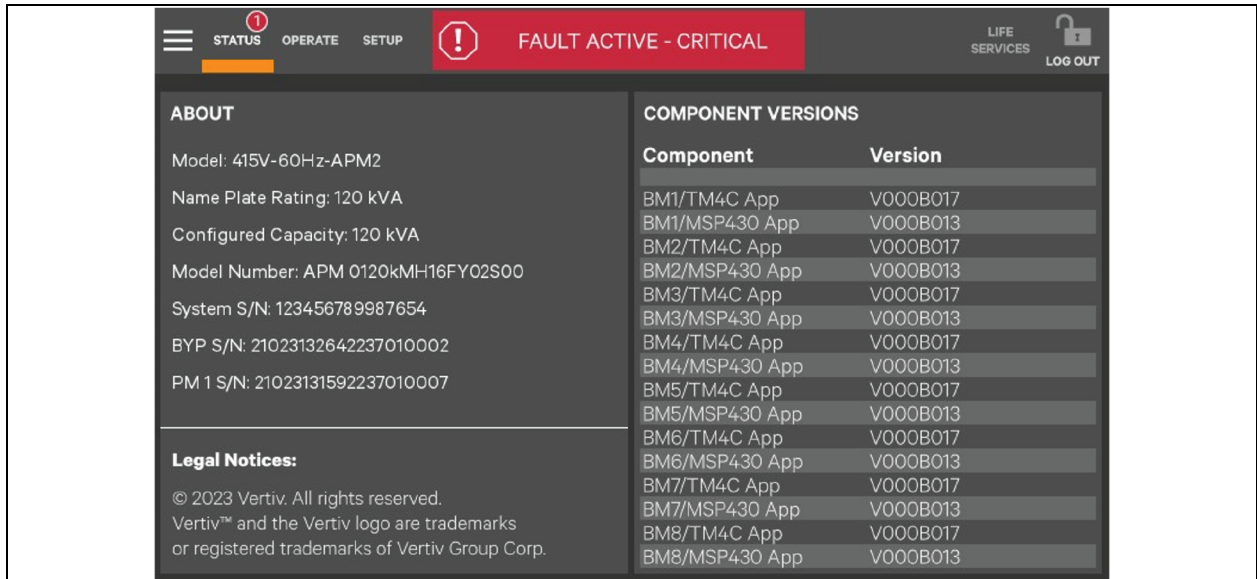

Figure 5.12 below shows the specific information of the lithium battery module of the HMI display, click on the *STATUS* in the upper left corner of the main screen then click on horizontal ellipses and then click on *EVENT LOG*, to view the specific log information of the battery.

Figure 5.12 Event Log Messages

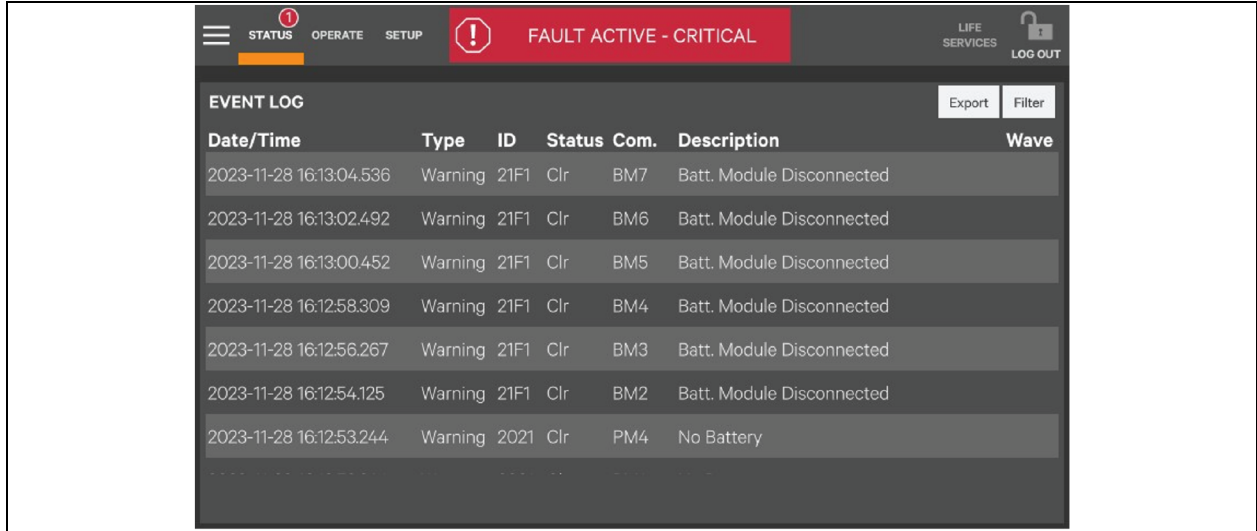
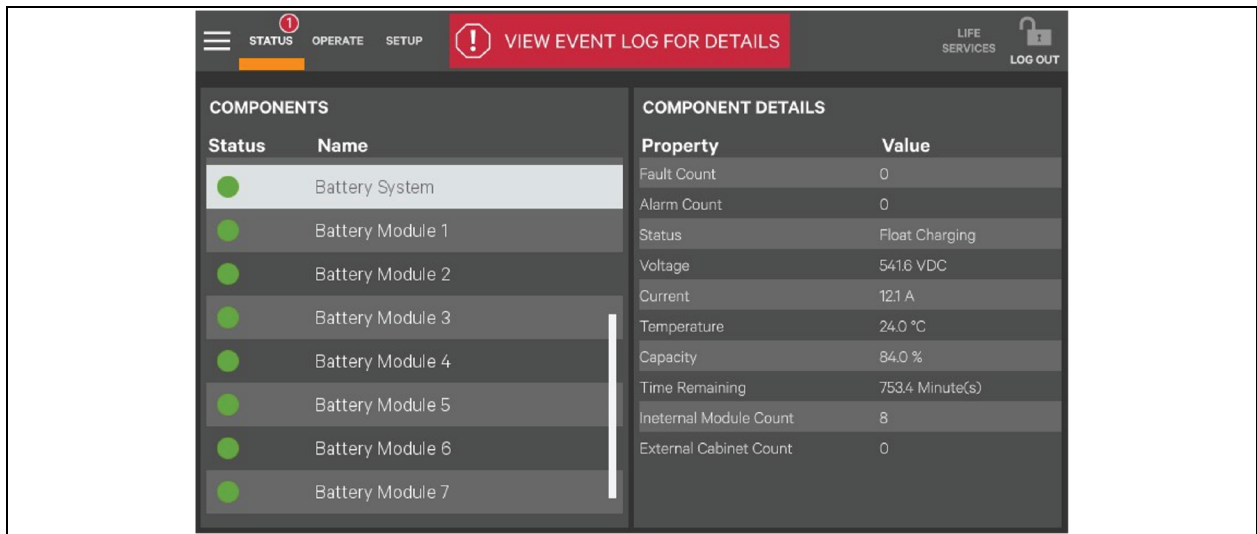

Figure 5.13 below shows the specific information of the lithium battery module on the HMI display, click on the *STATUS* in the upper left corner of the main screen, and then click on horizontal ellipses. Then click on *COMPONENT STATUS*, to view the lithium module component status.

Figure 5.13 Component Status



5.2 LED Display

Figure 5.14 LED Indicators

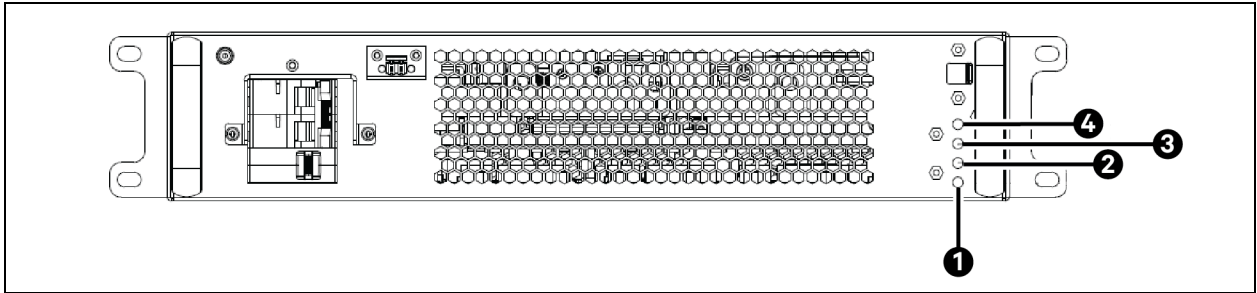

Item	Name	Descriptive	Operational State
1	BMS status	Low voltage indicator, green	Always On: BMS low voltage power ON Normally extinguished: BMS low voltage down
2	CHG/DISCHG Status	Charge, discharge, stand indicator, green	Always On: Charging Flashing: Discharge Normally extinguished: Standing
3	FAULT status	Fault indicator, red	Always On: Module fault Normally Off: Module is normal
4	HV/PRECHG status	High voltage indicator, pre-charge indicator, green	Always On: High voltage power ON Flashing: Pre-charging Normally extinguished: High voltage power OFF

5.3 Operation of Touchscreen

5.3.1 Access level login

The touchscreen has three access levels: Observer, operator, and administrator which provides different permissions and functions respectively.

Table 5.1 Access Level Login

Access Level		Observer	Operator	Administrator	Functional Description
Initial login password		No password required	1234	2345	LED Display on the previous page
UPS status		√	√	√	Operation of Touchscreen above
Operation	Alarm mute		√	√	LED Display on the previous page
	inverter operated switch on		√	√	
	Inverter shutdown		√	√	
	fault clearance		√	√	
	Energy saving mode switch		√	√	
	Battery discharge test		√	√	
Set-up	Network interface settings			√	
	Dial display settings			√	
	Sound alarm or not			√	
	Energy saving mode setting			√	

NOTE: The initial password is the factory default, only administrator can change the password.



CAUTION: Risk of unauthorized changes in settings and operation. Can cause damage to the equipment. Change the default password as soon as possible to prevent unauthorized persons from changing the UPS operation or even shutting down the UPS. Operator and administrator passwords can be changed at the administrator level.



ATTENTION: Risque de modifications non autorisées des réglages et du fonctionnement. Peut endommager l'équipement. Modifiez le mot de passe par défaut dès que possible pour éviter que des personnes non autorisées ne modifient le fonctionnement de l'onduleur, voire ne l'arrêtent. ou même d'arrêter l'onduleur. Les mots de passe de l'opérateur et de l'administrateur peuvent être modifiés au niveau de l'administrateur.

5.3.2 Touchscreens

The main screen after power ON is shown in **Figure 5.15** below. The information on the main screen is visible to all access level users.

Figure 5.15 Components Display at Main Page

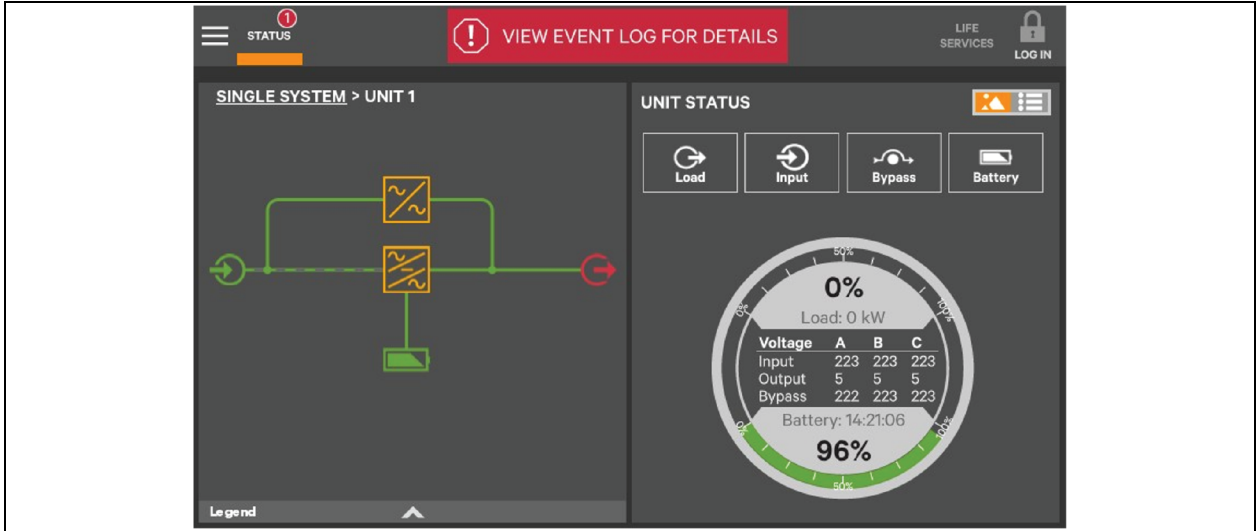

On the main page, the right side displays the current battery system's available power status SOC.

Figure 5.16 Components Display at Main Page

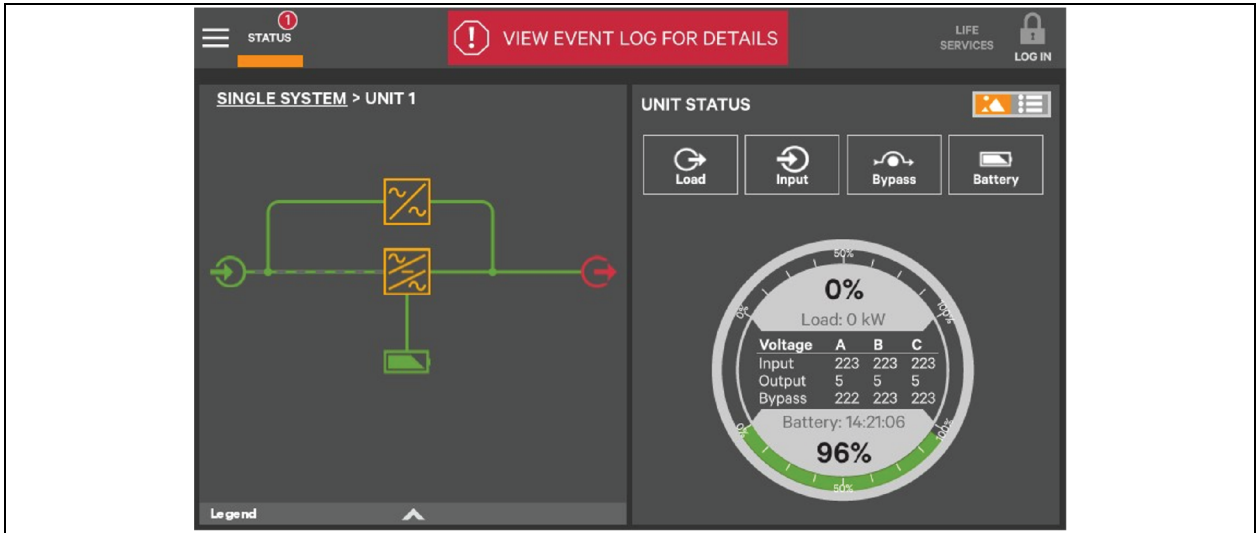

5.4 Alarm List

The **Table 5.2** below provides a complete list of all Vertiv™ Liebert® APM2 lithium battery module alarm messages that are displayed in the real time alarms and history menus.

Table 5.2 Alarm List

Serial Number	Alarm
1	No Battery
2	Battery Overtemperature
3	Battery Maintain
4	Low Battery
5	Battery End of Discharge
6	Battery Reset
7	Charger Shutdown
8	Battery Voltage High
9	Battery Voltage Low
10	Discharger Shutdown
11	Battery System Abnormal
12	Battery System Fault
13	Battery Module Fault
14	Battery System Communication Abnormal
15	Battery Module Disconnected
16	Battery Cell Voltage High
17	Battery Cell Voltage Low
18	Battery Overvoltage
19	Battery Undervoltage
20	Battery Cell Overvoltage
21	Battery Cell Undervoltage
22	Battery Under temperature
23	Battery Charge Overcurrent
24	Battery Discharge Overcurrent
25	Battery Balancing Abnormal
26	Load on Battery
27	Battery BMS Update
28	Battery IOB Update
29	Battery Discharge Test

This page intentionally left blank

6 Product Specification

This chapter provides product specifications for the Vertiv™ Liebert® APM2 lithium battery module.

6.1 Applicable Standards

The Liebert® APM2 lithium battery module is designed to meet European and international standards as shown in **Table 6.1** below.

Table 6.1 European and International Standards

Item	Standard
General safety requirements	EN62040-1/IEC62040-1/UL1973/UL9540A report
EMC requirements	EN62040-2/IEC62040-2 (CATEGORY C3)
Cell performance determination methodology and function, safety requirements	IEC62619, UL1642
Road transport safety standards	UN38.3

NOTE: The product standards listed in **Table 6.1** above, refer to the relevant provisions of the IEC and EN general standards for safety, electromagnetic radiation and immunity, and construction.

Notice

This is a product for commercial and industrial application in the second environment installation restrictions or additional measures may be needed to prevent disturbances.

6.2 Environmental Characteristics

Table 6.2 Environmental Characteristics

Item	Unit	Characteristics
Altitude	m	≤3000
Relative humidity	%RH	0 to 95, no condensation
Operating temperature	°C	Allowable charging and discharging environmental temperature range: 0 to 40
Storage temperature	°C	0 to +40
Transportation temperature	°C	-10 to 45
Recommended battery storage temperature	°C	15 to 35 (20 to 25 is the optimum battery storage temperature).
Low temperature discharge capacity/energy retention	/	≥70% (0°C, 1C) ≥60% (-10°C, 1C) ≥50% (-20°C, 1C)

6.3 Mechanical Characteristics

Table 6.3 Mechanical Characteristics

Item	Unit	Physical Parameter
Mechanical dimensions (W×D×H)	mm	796 x 440 x 87 (without package)
		1000 x 800 x 400 (with package)
Weight (maximum)	kg	36
Color	N/A	Panel EG7021
Protection class, IEC (60529)	N/A	IP20

6.4 Electrical Characteristics

Table 6.4 Electrical Characteristics

Item	Specification
Charge limit voltage	555.72 V
Rated voltage	475.2 V (3.6 V)
Discharge cut off voltage	382.8 V
Typical capacity	14 Ah
Maximum discharge current	168 A (single string system)
Maximum charging current	10 A (single string system)
Initial internal resistance value	≤200 milli ohms (measures its AC impedance at 1 kHz under half charged condition.)
Factory open circuit voltage	480 V to 490 V (3.63 V to 3.71 V/cell)
Charge and discharge energy efficiency	≥95% (25 °C, 1C)
Room temperature charge retention/capacity recovery rate	≥95% (25 °C, 100% SOC, 28 d)
Rated capacity	3207 Wh
Certification	UL: Exxxxx, CE, CB, UL1973 (CN: UL-US-2437742-0)\UL9540A(PN: 4791319335)

NOTE: The UL9450A report can be provided upon request to Vertiv Personnel.

Table 6.5 Cell and Module Characteristics

Cell	Module/stack	Cell	Module/stack
Manufacturer	—	Manufacturer	Vertiv Tech Co., Ltd.
Model	—	Model	APM2.0-LIB
Format	Cylindrical	Configuration: XP/YS	5P66S
Technology	NCA	Technology	NCA
Capacity, Ah	2.7	Capacity, Ah	13.5
Nominal Voltage, Vdc	3.6	Nominal Voltage, VDC	237.6

Table 6.5 Cell and Module Characteristics (continued)

Cell	Module/stack	Cell	Module/stack
Standard Charging Current, A	2.8	Standard Charging Current, A	2.5 < V ≤ 3.2: 5 3.2 < V ≤ 4.0: 10 4.0 < V ≤ 4.1: 5 4.1 < V ≤ 4.18: 3
Standard Full Charging Voltage, VDC	4.2	Standard Full Charging Voltage, VDC	275.22
End of Charging Current, A	0.05	End of Charging Current, A	3
Maximum Charging Current, A	4.25	Maximum Charging Current, A	2.5 < V ≤ 3.2: 5 3.2 < V ≤ 4.0: 10 4.0 < V ≤ 4.1: 5 4.1 < V ≤ 4.18: 3
Maximum Charging Voltage, Vdc	8.4	Maximum Charging Voltage, VDC	277.86
Standard Discharging Current, A	0.56	Standard Discharging Current, A	20
Discharge End Point Voltage, VDC	2.5	Discharge End Point Voltage, VDC	178.2 for Nominal discharging, 191.4 for Maximum Discharging Power
Maximum Discharge Current, A	35	Maximum Discharge Current, A	20 kW, 112 A
Charging Temperature Range, °C	-20~60	Charging Temperature Range, °C	0~40 (environmental temperature)
Discharging Temperature Range, °C	-40~60	Discharging Temperature Range, °C	0~40 (environmental temperature)
Cell Surface Temperature Limit, °C	80	Overcharge Voltage Protection, °C	Cell: 4.22±10; Battery: (4.21±10m) *66;
—	—	Overdischarging EODV limit Protection	Cell: 2.6 V±30 mV; Battery: (2.7 V±30 mV) *66;
—	—	Thermal protection ratings, °C	Charging: 60±1 (Surface of the cell), Discharge: 74±1 (Surface of the cell)
—	—	Short Circuit Protection Type and Ratings, A	Fuse: 125 (rated current)
—	—	Weight, kgs	36

This page intentionally left blank

7 Maintenance and Service

Vertiv™ Liebert® Lithium-ion UPS systems (including lithium-ion modules) require regular maintenance and maintenance during long term operation. Effective maintenance and maintenance of lithium battery modules can reduce the risk of lithium battery module failure and provide a longer service life. This chapter mainly describes the preventive maintenance, replacement, and quick diagnosis of common abnormal problems of the lithium battery module.

7.1 Maintenance Precautions

The routine inspection and maintenance of the lithium battery module can be carried out by personnel who have received relevant training, and the inspection and replacement of its components should be carried out by Vertiv authorized professionals. The parts behind the protective cover that can be opened only by tools are not operable by users. Only qualified maintenance personnel are allowed to open the protective cover. When maintaining the lithium battery module, use the insulated tools to make sure that the safe electrical operation.

When using lithium battery modules, pay attention to the below points:

- Even if the lithium battery module is not running, there is still a deadly dangerous voltage inside it. Before maintenance of the module, to ensure safety, it is necessary to measure the voltage between the site to be operated and the ground to ensure that it is lower than the dangerous voltage value, that is the DC is lower than 60 VDC.
- When using lithium battery modules, do not wear watches, bracelets, rings, and other conductive items on hands.
- When in doubt about the use of the equipment, contact the local Vertiv technical support.

7.2 Routine Maintenance

To improve the reliability and stability of the lithium battery module operation, it is necessary to complete the preventive maintenance work during the use of regular inspections:

- Regularly inspect the operating environment, check the temperature and humidity of the working environment of the lithium module, and keep record of the data to ensure that the lithium module operates in the best environmental conditions.
- Regularly check the operation of the fan of the supporting UPS, if the fan operation fails, immediately replace the corresponding power module.
- If the operation site is dusty, clean or replace the dust net of the cabinet every half a year to avoid the temperature inside the cabinet rising due to poor air ducts, which affects the operation life of lithium battery modules.
- Regularly check the SOC and SOH of all lithium modules to ensure that the lithium modules are in good operating condition.
- Use the upper computer or use the network background at any time to monitor the operating status of the entire machine, alarms or failures in time to troubleshooting.

7.3 Module Replacement

IMPORTANT! Module replacement operations must be performed by Vertiv service personnel.

Before module replacement, it is necessary to confirm the operating status of the supporting UPS and the load situation, to avoid the operation affecting the UPS power supply for the load.

Before and after the module replacement, confirm that the module is not mixed with other types of battery modules such as lead-acid modules.

If a malfunction occurs that requires lithium module replacement, refer to the below procedure:

1. Disconnect the lithium battery module circuit breaker, power OFF the lithium battery module, turn the lock switch to the unlocked state, and wait for all the lithium battery module indicator lights to be OFF.
2. Remove the fixing screws on both sides of the front panel of the lithium battery module and pull out the module.
3. Insert the new lithium battery module or the maintained module back into its original position and tighten the fixing screws with a tool.
4. Toggle the module's lock switch to a locked state, close the module's blanking switch, and wait for the module to join the power reserve.

NOTE: During operation, use insulated tools, insulated safety shoes and a safety officer should be available onsite to ensure safe operation.

NOTE: When the battery module is pulled out halfway, care needs to be taken to protect the safety of the battery module from slipping off.

IMPORTANT! The voltage of the lithium battery module and SOC consistency is very important for the normal operation of the system, in the process of replacing the lithium battery module, it is recommended that the total voltage difference between the newly replaced lithium module and the lithium battery module in the same cluster of batteries is less than 10 V, to avoid affecting the ability to prepare for the power.

IMPORTANT! When replacing a module in a battery cluster, it is recommended that the air switch of the other lithium battery module in the cluster be synchronized OFF.



WARNING! It is prohibited to open or disassemble the lithium battery module on site.



AVERTISSEMENT! Il est interdit d'ouvrir ou de démonter le module de batterie au lithium sur place.



WARNING! Recycling of lithium battery modules should comply with local regulations.



AVERTISSEMENT! Le recyclage des modules de piles au lithium doit être conforme aux réglementations locales.



WARNING! Make sure that the circuit breaker is disconnected, and the lock switch is toggled to the unlocked state when replacing the lithium battery module. If transportation is required, it is recommended to use the original package of Vertiv.



AVERTISSEMENT! Assurez-vous que le disjoncteur est déconnecté et que l'interrupteur de verrouillage est déverrouillé lorsque vous remplacez le module de la pile au lithium. En cas de transport, il est recommandé d'utiliser l'emballage d'origine de Vertiv.

7.4 Routine Maintenance

7.4.1 General

The factory SOC of the Vertiv™ Liebert® APM2 lithium battery module is 70% to 80%. When using the APM2 for the first time, start the UPS to charge the lithium battery module. During this process, the lithium battery module has the power backup capability, but the backup time is shorter than the standard value.

Lithium battery modules need to be regularly replenished during long term storage, supplementing the SOC to more than 40%.

When cleaning the lithium battery module shell, only use a wet rag to wipe, do not use alcohol, gasoline, diluent, and other organic solvents.

Periodically check the ambient temperature of the lithium battery module. The most suitable temperature for the battery is 20°C to 25°C.

Regularly check the MCB and lock of the Liebert® APM2 lithium battery module for anomalies to ensure that the input or output can be cut off when the current is too large.

Maintenance personnel should be familiar with the typical operating conditions of the Liebert® APM2 lithium battery module so that they can quickly locate the abnormal environmental conditions should also be familiar with the Liebert® APM2 lithium battery module display light display state.

7.4.2 Diagnosis of common problems

Table 7.1 Diagnosis of Common Problems

Serial Number	Abnormal Phenomenon	Possible Causes
1	The touchscreen reports a battery communication failure.	Poor connection of battery cell module, loose can communication cable.
2	System overload reported after utility battery cut.	Mismatch between the number of battery modules and load power.
3	Utility power is normal, but the lithium module is not charging.	The total voltage of battery module is abnormal or normal communication is not established.
4	High voltage indicator does not light up after the battery air switch is closed.	Faulty high voltage indicator or abnormal power supply to the main channel or faulty high voltage abnormality.
5	Battery module red light on.	Battery module failure.

7.4.3 Emergency management

When the system reports a malfunction and the touchscreen lights up yellow or red, first check the type of malfunction through the touchscreen to determine the cause of the malfunction. If it is caused by a battery malfunction, confirm the type of malfunction, open the door of the cabinet, and observe the front panel of the lithium-ion module to see if it is lit up with a red light, turn off the malfunctioning battery if necessary, to avoid the malfunction from expanding, and notify the Vertiv technical service personnel in time.

Disassembly of faulty modules is prohibited and must be handled by Vertiv authorized personnel.

7.5 Maintenance Record of Lithium Battery Module

Table 7.2 Vertiv™ Liebert® APM2 Lithium Battery Module Maintenance Record Sheet

Form	Test Items	Record	Test Items	Record
Environmental indicators	Temp		Humidity level	
	Dust mesh status		Power module fans	
Lithium module basic information	Lithium module equipment code		Device status	
	Service life		Total battery pack voltage	
	Current SOC		Current SOH	
Battery parameter logging	Maximum cell voltage		Minimum cell voltage	
	Maximum cell temperature		Minimum cell temperature	
Warning	Current alarms		Historical alarm messages	
	Historic preservation information		Historical fault information	

8 Packaging, Transportation, Storage

8.1 Package

The packaging of lithium battery modules meets the requirements of ISTA 3B for package transportation, with labels printed on the boxes for fear of moisture, careful and light handling, upward, and number of stacked layers. Contact the carrier and Vertiv local service personnel in a timely manner in case of any damage to the packaging caused by dropping, tipping, and squeezing. If the lithium module needs to be repacked, the original Vertiv packaging needs to be used.

8.2 Transport

When transporting or handling lithium battery modules, strictly follow the warning labels on the packing cases. Do not transport flammable, explosive, or corrosive materials together. Lithium battery module with UN38.3 and dangerous package certification can use land transport, air transport, sea transport. It is recommended to use lithium battery transport qualifications of the car transport, and choose a better road condition, to avoid too much turbulence.

8.3 Storage

If the lithium battery module does not need to be installed immediately, store the module indoors with the original package to avoid excessive humidity or high temperature. Lithium battery modules need to be stored in a dry, low temperature, well-ventilated place, the most suitable storage temperature is 20°C to 25°C, not with flammable, explosive, corrosive, and strong magnetic items common storage.

Lithium battery modules stored for more than six months unused, user must charge/discharge the whole cabinet. If other abnormal problems are encountered, call the Vertiv technical service number or consult local technical service engineer.

This page intentionally left blank

Appendices

Appendix A: Technical Support and Contacts

A.1 Technical Support/Service in the United States

Vertiv Group Corporation

24x7 dispatch of technicians for all products.

1-800-543-2378

Liebert® Thermal Management Products

1-800-543-2378

Liebert® Channel Products

1-800-222-5877

Liebert® AC and DC Power Products

1-800-543-2378

A.2 Locations

United States

Vertiv Headquarters

505 N Cleveland Ave

Westerville, OH 43082

Europe

Via Leonardo Da Vinci 8 Zona Industriale Tognana

35028 Piove Di Sacco (PD) Italy

Asia

7/F, Dah Sing Financial Centre

3108 Gloucester Road, Wanchai

Hong Kong

Appendix B: Battery Backup Timetable

Table 9.1 Battery Backup Timetable

APM2 400/480 V UPS FR1, Power Factor = 1, 25 °C										
UPS Rating—KVA	Strings	20	30	40	50	60	80	90	100	120
Internal Batteries 1 string = 2 shelves = 2 LIB	1	15.0	10.0	6.1	4.4	2.7	NA	NA	NA	NA
	2	30.0	20.0	15.0	12.0	10.0	6.1	5.0	4.4	2.7
	3	45.0	30.0	22.0	18.0	15.0	11.0	10.0	9.0	6.1
	4	60.0	40.0	30.0	24.0	20.0	15.0	13.0	12.0	10.0

NOTE: * This backup schedule corresponds to the ambient temperature of 25 °C and the discharge time under full charge. It can match 120 kVA 400 V and 120 kVA 480 V models.

APM2 400/480 V UPS FR1, Power Factor =1, 45 °C										
UPS Rating—KVA	Strings	20	30	40	50	60	80	90	100	120
Internal Batteries 1 string = 2 shelves =2 LIB	1	13.5	9.0	5.5	3.9	2.4	NA	NA	NA	NA
	2	27.0	18.0	13.5	10.8	9.0	5.5	4.5	3.9	2.4
	3	40.5	27.0	19.8	16.2	13.5	9.9	9.0	8.1	5.5
	4	54.0	36.0	27.0	21.6	18.0	13.5	11.7	10.8	9.0

NOTE: *This backup schedule corresponds to the ambient temperature of 45 °C and the discharge time under full charge. It can match 120 kVA 400 V and 120 kVA 480 V models.

APM2 208 V UPS FR1, Power Factor =1, 25 °C										
UPS Rating—KVA	Strings	10	15	20	25	30	40	45	50	60
Internal Batteries 1 string = 1 shelf = 1 LIB	1	15.0	10.0	6.1	4.4	2.7	NA	NA	NA	NA
	2	30.0	20.0	15.0	12.0	10.0	6.1	5.0	4.4	2.7
	3	45.0	30.0	22.0	18.0	15.0	11.0	10.0	9.0	6.1
	4	60.0	40.0	30.0	24.0	20.0	15.0	13.0	12.0	10.0
	5	75.0	50.0	36.0	30.0	25.0	18.0	16.0	15.0	12.0
	6	90.0	60.0	45.0	36.0	30.0	22.0	20.0	18.0	15.0
	7	105.0	70.0	51.0	42.0	35.0	26.0	24.0	21.0	17.0
	8	120.0	80.0	60.0	48.0	40.0	30.0	26.0	24.0	20.0

NOTE: * This backup schedule corresponds to the ambient temperature of 25 °C and the discharge time under full charge, and can match the 60 kVA 208 V model.

APM2 208 V UPS FR1, Power Factor =1, 45 °C										
UPS Rating—KVA	Strings	10	15	20	25	30	40	45	50	60
Internal Batteries 1 string = 1 shelf =1 LIB	1	13.5	9.0	5.5	3.9	2.4	NA	NA	NA	NA
	2	27.0	18.0	13.5	10.8	9.0	5.5	4.5	3.9	2.4
	3	40.5	27.0	19.8	16.2	13.5	9.9	9.0	8.1	5.5
	4	54.0	36.0	27.0	21.6	18.0	13.5	11.7	10.8	9.0
	5	67.5	45.0	32.4	27.0	22.5	16.2	14.4	13.5	10.8
	6	81.0	54.0	40.5	32.4	27.0	19.8	18.0	16.2	13.5
	7	94.5	63.0	45.9	37.8	31.5	23.4	21.6	18.9	15.3
	8	108.0	72.0	54.0	43.2	36.0	27.0	23.4	21.6	18.0

NOTE: * This backup schedule corresponds to the ambient temperature of 45 °C and the discharge time under full charge, and can match the 60 kVA 208 V model.

Appendix C: Hazardous Substances and Content

Table 9.2 Hazardous Substances and Content

Part Name	Hazardous Substances									
	Cadmium (Pb)	Mercury (chemistry) (Hg)	Chromium (Cd)	Hexavalent chrome (Cr (VI))	Polybrominated biphenyl (PBB)	Polybrominated diphenylether (PBDE)	Bis(2-ethylhexyl) phthalate (DEHP-Di(2-ethylhexyl) Phthalate)	Butylbenzyl phthalate (BBP-Benzyl Butyl Phthalate)	Dibutyl phthalate (DBP-Di-n-butyl Phthalate)	Dibutyl phthalate (DIBP-Dibutyl Phthalate)
Hexagonal copper studs	x	○	○	○	○	○	○	○	○	○
Finished plate	x	○	○	○	○	○	○	○	○	○
AC capacitor	x	○	○	○	○	○	○	○	○	○
DC capacitance	x	○	○	○	○	○	○	○	○	○
Fan	x	○	○	○	○	○	○	○	○	○
Cable	x	○	○	○	○	○	○	○	○	○
LCD	x	○	○	○	○	○	○	○	○	○
Detection element	x	○	○	○	○	○	○	○	○	○
Magnetic element	x	○	○	○	○	○	○	○	○	○
CB/rotary switch	x	○	○	○	○	○	○	○	○	○
Semiconductor device	x	x	○	○	○	○	○	○	○	○
Electric core	x	○	○	○	○	○	○	○	○	○

NOTE: This table is made according to the regulation of SJ/T 11364.

○ : Means the content of the hazardous substances in all the average quality materials of the parts is within the limits specified in GB/T 26572.

x: Means the content of the hazardous substances in at least one of the average quality materials of the parts is outside the limits specified in GB/T 26572.

Applicable scope: Lithium battery module

Connect with Vertiv on Social Media



<https://www.facebook.com/vertiv/>



<https://www.instagram.com/vertiv/>



<https://www.linkedin.com/company/vertiv/>



<https://www.x.com/Vertiv/>



Vertiv.com | Vertiv Headquarters, 505 N Cleveland Ave, Westerville, OH 43082 USA

©2024 Vertiv Group Corp. All rights reserved. Vertiv™ and the Vertiv logo are trademarks or registered trademarks of Vertiv Group Corp. All other names and logos referred to are trade names, trademarks or registered trademarks of their respective owners. While every precaution has been taken to ensure accuracy and completeness here, Vertiv Group Corp. assumes no responsibility, and disclaims all liability, for damages resulting from use of this information or for any errors or omissions.

SL-71173_REVD_11-24