



**Solution: SR2N04020PAA1**

<b>1. Change Log.....</b>	<b>3</b>
<b>2. Site Planning Datasheet.....</b>	<b>4</b>
<b>3. Interconnection Guide (ICG).....</b>	<b>5</b>
<b>4. Field Supplied Cable &amp; Part List .....</b>	<b>20</b>
<b>5. Vertiv MSR2 600mm IT Rack .....</b>	<b>21</b>
<b>6. Vertiv MSR2 Power Management Cabinet (PMC) .....</b>	<b>22</b>
<b>7. Vertiv Liebert CR019 with Plenums .....</b>	<b>23</b>
<b>8. Power Management Unit - 20kW (PMU20).....</b>	<b>24</b>
<b>9. PMU20 Terminal Blocks Size.....</b>	<b>25</b>
<b>10. Vertiv MSR2 - CT600 Cable Tray 600mm .....</b>	<b>26</b>
<b>11. Scope of Work .....</b>	<b>27</b>

# 1. Change Log

Rev	Date	Author	Description	Number of Change
A	1/29/2024	MG	Initial Release	CO-1083702
B	4/4/2024	TK	Updated site planning datasheet, minor changes to interconnection guide, removal of SOW checklist	CO-1087618
C	6/10/2024	TK	Updated connection guide, added updated SOW checklist, updated design	CO-1091967
D	9/3/2024	TK	Updated interconnection guide (cable sets, row views), updated SOW, updated design	CO-1097623

## 2. Site Planning Datasheet

### Smart Row 2 Site Planning Datasheet (208V, 3 phase, 4 wire + PE)





Configuration Number	Part Number	Max Row Capacity (kW)	IT Racks per Row	Capacity per Rack (kW)	Cooling Units per Row	pdu count	Main Input Breaker Size <sup>6</sup>	Per Condenser Breaker Size	Per Condenser Dry Weight kg (lbs)	Row Dimensions (L x H x D) mm (in) <sup>7</sup>	Row Weight kg (lbs)	Min. Staging Area m <sup>2</sup> (ft <sup>2</sup> )
1	SR2N02010NAA1	10	2	5	1	2	100A	N/A <sup>5</sup>	60 (132.3)	2100 (82.7) x 2271 (107) x 1400 (55.2)	1463 (3227)	14.41 (155.2)
2	SR2N02010PAA1	10	2	5	1	4	100A	N/A <sup>5</sup>	60 (132.3)	2100 (82.7) x 2271 (107) x 1400 (55.2)	1491 (3288)	14.99 (161.4)
3	SR2N02010FAA1	10	2	5	2	4	100A	N/A <sup>5</sup>	60 (132.3)	2400 (94.5) x 2271 (107) x 1400 (55.2)	2112 (4656)	17.67 (190.2)
4	SR2N03010NAA1	10	3	3	1	3	100A	N/A <sup>5</sup>	60 (132.3)	2700 (106.3) x 2271 (107) x 1400 (55.2)	1633 (3601)	15.76 (169.7)
5	SR2N03010PAA1	10	3	3	1	6	100A	N/A <sup>5</sup>	60 (132.3)	2700 (106.3) x 2271 (107) x 1400 (55.2)	1675 (3694)	16.34 (175.9)
6	SR2N03010FAA1	10	3	3	2	6	100A	N/A <sup>5</sup>	60 (132.3)	3000 (118.2) x 2271 (107) x 1400 (55.2)	2296 (5061)	19.02 (204.8)
7	SR2N03020NAA1	20	3	6	1	3	175A	15A	118 (260.2)	2700 (106.3) x 2271 (107) x 1400 (55.2)	1863 (4108)	18.46 (198.8)
8	SR2N03020PAA1	20	3	6	1	6	175A	15A	118 (260.2)	2700 (106.3) x 2271 (107) x 1400 (55.2)	1905 (4201)	20.51 (220.8)
9	SR2N03020FAA1	20	3	6	2	6	175A	15A	118 (260.2)	3000 (118.2) x 2271 (107) x 1400 (55.2)	2526 (5568)	24.42 (262.9)
10	SR2N04020NAA1	20	4	5	1	4	175A	15A	118 (260.2)	3300 (130) x 2271 (107) x 1400 (55.2)	2033 (4483)	19.81 (213.3)
11	SR2N04020PAA1	20	4	5	1	8	175A	15A	118 (260.2)	3300 (130) x 2271 (107) x 1400 (55.2)	2089 (4607)	21.86 (235.3)
12	SR2N04020FAA1	20	4	5	2	8	175A	15A	118 (260.2)	3600 (141.8) x 2271 (107) x 1400 (55.2)	2710 (5974)	25.77 (277.4)
13	SR2N05020NAA1	20	5	4	1	5	175A	15A	118 (260.2)	3900 (153.6) x 2271 (107) x 1400 (55.2)	2203 (4858)	21.16 (227.8)
14	SR2N05020PAA1	20	5	4	1	10	175A	15A	118 (260.2)	3900 (153.6) x 2271 (107) x 1400 (55.2)	2273 (5012)	23.21 (249.9)
15	SR2N05020FAA1	20	5	4	2	10	175A	15A	118 (260.2)	4200 (165.4) x 2271 (107) x 1400 (55.2)	2894 (6380)	27.12 (292)

**Notes:**

- System Environmental Conditions: Indoors, 41 °F to 104 °F (5 °C to 40 °C), RH to 80% with Max dew point of 82.4 °F (28 °C)
- Floor surface must be level and continuous (expansion joints sealed, raised floor tile gaps sealed, no floor drains, etc).
- No building sprinkler head should be within 19.7 in (0.5 m).
- Install in accordance with national and local electrical codes
- 10kW condenser power is sourced from the indoor unit
- Cable Sizing: 100A = 3 AWG ; 175A = 2/0 AWG
- Row Dimensions do not include necessary space needed for access including per ADA or local codes.

SHEET NO.	DRAWN BY:	© 2024 VERTIV GROUP CORPORATION. CONFIDENTIAL AND PROPRIETARY. ALL RIGHTS RESERVED. VERTIV AND THE VERTIV LOGO ARE TRADEMARKS OR REGISTERED TRADEMARKS OF VERTIV GROUP CORPORATION. THIS DOCUMENT (AND THE INFORMATION IT CONTAINS) ARE THE PROPERTY OF VERTIV GROUP CORPORATION. BY ACCEPTING IT INTO YOUR POSSESSION, YOU AGREE THAT YOU WILL KEEP THIS DOCUMENT AND ALL INFORMATION CONTAINED HEREIN IN STRICTEST CONFIDENCE AND WILL NOT COPY, REPRODUCE, RETRANSMIT, USE (EXCEPT SOLELY FOR THE BENEFIT OF VERTIV GROUP CORPORATION), SELL, LEND, OR OTHERWISE DISPOSE OF SAME, DIRECTLY OR INDIRECTLY, WITHOUT THE EXPRESS WRITTEN PERMISSION OF VERTIV GROUP CORPORATION. IMMEDIATELY UPON REQUEST.	DWG. NO. DATE (LATEST REV) REVISION 506 N. CLEVELAND AVE WESTERVILLE, OHIO 43081	
	DESIGNED BY:			
CO. NO.	TITLE	Smart Row 2 Site Planning Datasheet (208V, 3 phase, 4 wire + PE)		
REF. DWG.	APPROVED BY:			

### 3. Interconnection Guide (ICG)

0	1	2	3	4	5	6	7	8	9
A	 <p><b>Vertiv Row Solution</b>                  Knowledge to Build Optimized Infrastructure Solutions</p>								
B	<p>Vertiv™ SmartRow™ 2: 4x IT Rack 20kW</p>								
C									
D	<p>Row IT Load Capacity: 20 kW                  Power Redundancy UPS: Yes                  Power Redundancy rPDU: Yes                  Cooling Redundancy: No                  Dimensions:                  Length: 10.82 ft [3300 mm]                  Depth: 4.6 ft [1400 mm]                  Height: 7.38 ft [2250 mm]</p>								
E									
SHEET NO. 1 / 15 CHANGE NO. PAGE DESCRIPTION: 1- Title page / cover sheet	DRAWN BY: Nilesch Patil APPROVED BY: Jakub Fendl	© 2020 VERTIV GROUP CORPORATION. CONFIDENTIAL AND PROPRIETARY. ALL RIGHTS RESERVED. VERTIV AND THE VERTIV LOGO ARE TRADEMARKS OR REGISTERED TRADEMARKS OF VERTIV GROUP CORPORATION. THIS DOCUMENT (AND THE INFORMATION IT CONTAINS) ARE THE PROPERTY OF VERTIV GROUP CORPORATION BY ACCEPTING IT INTO YOUR POSSESSION, YOU AGREE THAT YOU WILL KEEP THIS DOCUMENT AND ALL INFORMATION CONTAINED HEREIN IN STRICTEST CONFIDENCE AND WILL NOT COPY, REPRODUCE, USE (EXCEPT SOLELY FOR THE BENEFIT OF VERTIV GROUP CORPORATION), SELL, LEND, OR OTHERWISE DISPOSE OF SAME, DIRECTLY OR INDIRECTLY, WITHOUT THE EXPRESS WRITTEN PERMISSION OF VERTIV GROUP CORPORATION, AND THIS DOCUMENT SHALL BE RETURNED TO VERTIV GROUP CORPORATION IMMEDIATELY UPON REQUEST.	DWG NO. SR2N04020PAA1 DATE (LATEST REV.) REVISION: 505 N. CLEVELAND AVE WESTERVILLE OH 43081	 <b>VERTIV™</b>					



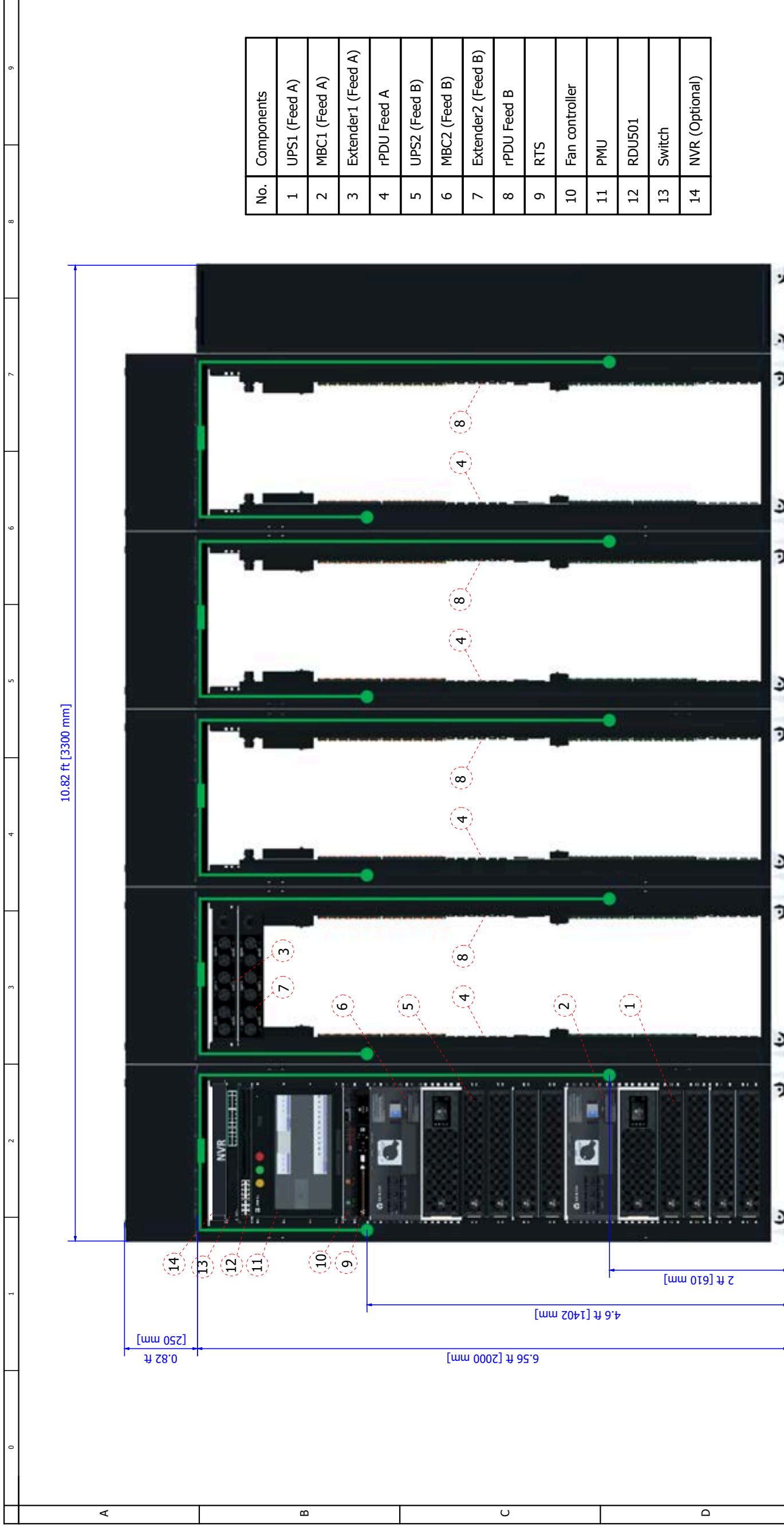

Front View

No.	Components
1	UPS1 (Feed A)
2	MBC1 (Feed A)
3	Extender1 (Feed A)
4	rPDU Feed A
5	UPS2 (Feed B)
6	MBC2 (Feed B)
7	Extender2 (Feed B)
8	rPDU Feed B
9	RTS
10	Fan controller
11	PMU
12	RDU501
13	Switch
14	NVR (Optional)

Notes:

1. Row IT Load Capacity is driven by number of IT-Racks (IT-Rack x 5 kW per rack).
2. System Environmental Conditions: Indoors, 41 F to 104 F (5 C to 40 C), RH to 80% with Max dew point of 82.4 F (28 C).
3. Floor surface must be level and continuous (expansion joints sealed, raised floor tile gaps sealed, no floor drains, etc).
4. No building sprinkler head should be within 19.7 in (0.5 m).

— 2T Sensor mounted on rack roof  
 ● 2T Sensor probe

SHEET NO. 2 / 15	DRAWN BY: Nilesch Patil	DWG NO. SR2N04020PAA1	
CHANGE NO.	APPROVED BY: Jakub Fendl	DATE (LATEST REV.): 21.08.2024	
PAGE DESCRIPTION: 2 - vRow Front View	TITLE / DESCRIPTION: Vertiv™ SmartRow™ 2: 4x IT Rack 20kW		REVISION: 505 N. CLEVELAND AVE WESTERVILLE OH 43081

### PMC Connection Details

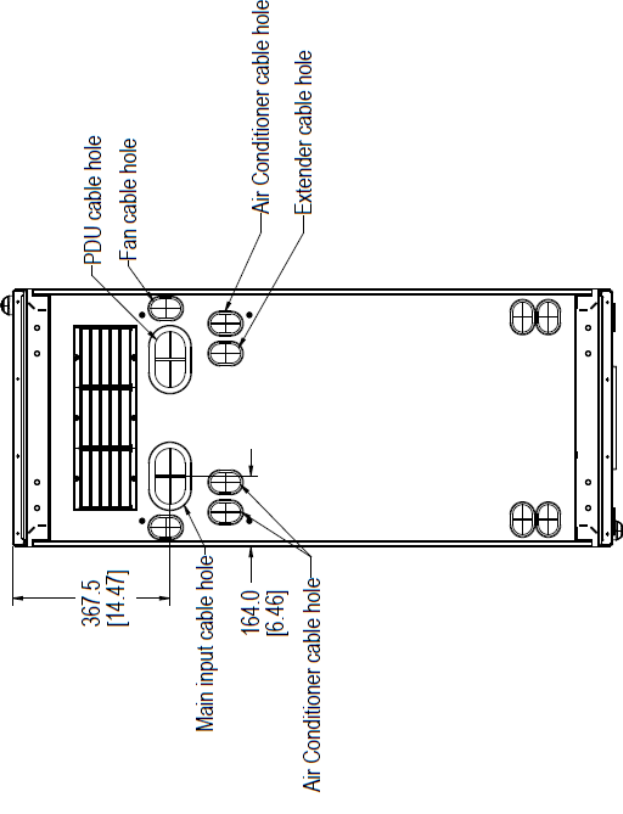

### Top View

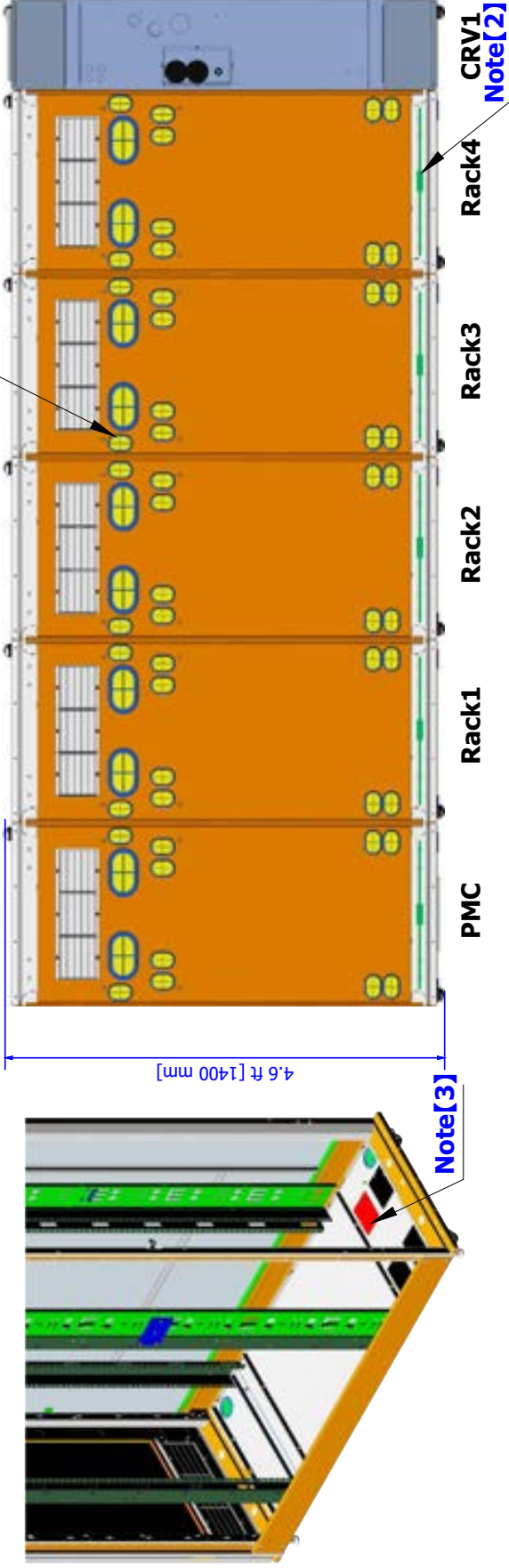

- Note :-**
- 1. Cable trough not shown to make top panel details visible.
  - 2. 2T sensors mounted to top of racks.
  - 3. Do not use the marked hole for bottom cable routing.

### CRV Connection Details

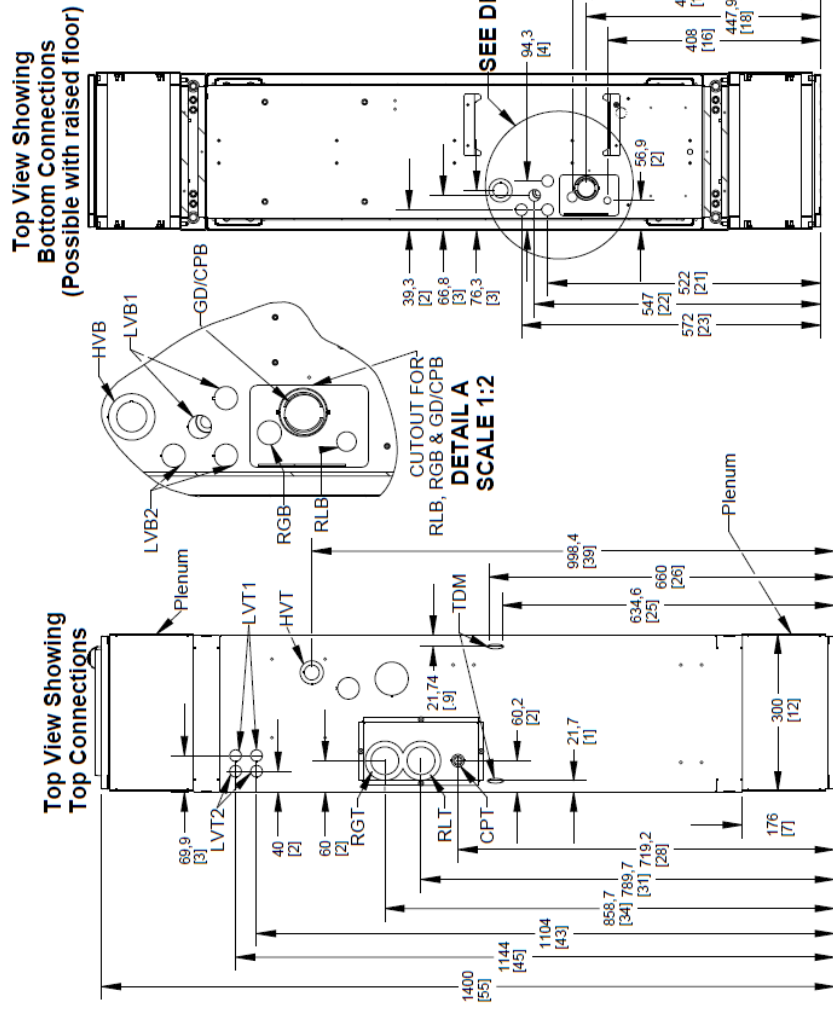

Unit Top Connections		Unit Bottom Connections	
RLT	Refrigerant Liquid Line Inlet	RLB	Refrigerant Liquid Line Inlet
RGT	Refrigerant Gas Line Outlet	RGB	Refrigerant Gas Line Outlet
CPT	Condensate Pump	GD	Gravity Coil Pan Drain
HVT	High Voltage Top Connection	CPB	Condensate Pump
LVT1	Low Voltage (Twisted Pair)	HVB	High Voltage Bottom Entrance (feed through the base of the unit)
LVT2	Low Voltage (Shielded Cable)	LVB1	Low Voltage (Twisted Pair)
TDM	Tie Down (Top) Mounting	LVB2	Low Voltage (Shielded Cable)

**Note :- Pipe sizes are for connection purposes and not the required line size. Consult thermal manuals for line sizes.**

Front of Unit  
Dimensions in "mm[in]"  
(Internal Piping and top of unit hidden for clarity)

SHEET NO. 3 / 15

DRAWN BY: Nilesch Patil

APPROVED BY: Jakub Fend

PAGE DESCRIPTION: 2. a-vRow Top View

© 2020 VERTIV GROUP CORPORATION. ALL RIGHTS RESERVED. VERTIV AND THE VERTIV LOGO ARE TRADEMARKS OR REGISTERED TRADEMARKS OF VERTIV GROUP CORPORATION. THIS DOCUMENT (AND THE INFORMATION IT CONTAINS) ARE THE PROPERTY OF VERTIV GROUP CORPORATION. BY ACCEPTING IT INTO YOUR POSSESSION, YOU AGREE THAT YOU WILL KEEP THIS DOCUMENT AND ALL INFORMATION CONTAINED HEREIN IN STRICT CONFIDENCE AND WILL NOT COPY, REPRODUCE, MIRROR, TRANSMIT, OR OTHERWISE DISCLOSE OF SAME, DIRECTLY OR INDIRECTLY, WITHOUT THE EXPRESS WRITTEN PERMISSION OF VERTIV GROUP CORPORATION, AND THIS DOCUMENT SHALL BE RETURNED TO VERTIV GROUP CORPORATION IMMEDIATELY UPON REQUEST.

DATE (LATEST REV.)  
DWG NO. SR2N04020PAA1

REVISION:  
505 N. CLEVELAND AVE. WESTERVILLE OH 43081

TITLE / DESCRIPTION: Vertiv™ SmartRow™ 2: 4x IT Rack 20kW

## Cable overview

Packaging No.	Cable Category	Cable No.	Tag1	Tag2	Length (inch/mm)	Description
0411A817	Rear door microswitch cascade	W218	PMC_R-SW	RACK_R-SW	25.6/650	PMC to RACK1 cascade cables for rear door microswitches
	Rear door light cascade cable	W220	PMC_RLIGHT	RACK_RLIGHT	25.6/650	PMC to RACK1 rear door LED light cascade cable
	Water immersion to RDU501	W121	Water_Leak2	RDU501_DI1	216.5/5500	Water immersion 1 to RDU501 communication cable
	Smart door lock cascade cable	W209	RACK-FLOCK	AC-FLOCK	13.8/350	RACK4 to CRV1 F-Door communication cascade cable
	Smart door lock cascade cable	W201	PMC-LOCK	RACK-LOCK	25.6/650	PMC to RACK1 power cascade cable
	Smart door lock cascade cable	W221	PMC-RLOCK	RACK-RLOCK	25.6/650	PMC to RACK1 R-Door communication cascade cable.
	Smart door lock cascade cable	W206/W207	I-LOCK	F-R/BK W206, R-R/BK W207	82.7/2100	Smart door lock cable from rear door to front door in CRV1
	CRV's microswitch and Smart door lock cascade	W401-L	RDU-Smoke2	W401-L 385	177.17/4500	Microswitch communication cable from PMC to CRV1
	Emergency fan to FC	W229	FC Port1	PMC-FAN	59.1/1500	PMC Emergency fan to FC controller cable
	Emergency fan to FC	W213	FC Port2/3	RACK1/2-FAN	122/3100	Rack1 Emergency fan to FC controller cable (shorter)
	Emergency fan to FC	W213	FC Port2/3	RACK1/2-FAN	122/3100	Rack2 Emergency fan to FC controller cable (shorter)
	Emergency fan to FC	W214	FC Port4/5/6	RACK3/4/5-FAN	177.2/4500	Rack3 Emergency fan to FC controller cable (longer)
	Emergency fan to FC	W214	FC Port4/5/6	RACK3/4/5-FAN	177.2/4500	Rack4 Emergency fan to FC controller cable (longer)
	Communication cable	W114	FC	Switcher(From FC)	70.9/1800	FC to Switch communication cable
	Communication cable	W115	PDU	Switcher(From PDU)	137.8/3500	PDU to Switch communication cable
	Communication cable	W119	RDU501	Switcher(From RDU501)	47.2/1200	RDU501 to Switch Communication Cable
	Communication cable	W116	PDU	PDU	157.5/4000	PDU1A to PDU1B communication cable
Communication cable	W117	PDU	PDU	118.1/3000	PDU1B to PDU2A communication cable	
Communication cable	W116	PDU	PDU	157.5/4000	PDU2A to PDU2B communication cable	
Communication cable	W117	PDU	PDU	118.1/3000	PDU2B to PDU3A communication cable	
Communication cable	W116	PDU	PDU	157.5/4000	PDU3A to PDU3B communication cable	
Communication cable	W117	PDU	PDU	118.1/3000	PDU3B to PDU4A communication cable	
Communication cable	W116	PDU	PDU	157.5/4000	PDU4A to PDU4B communication cable	
Power cable	W12	PMU TO CRV2 L1 L2 N G	-	144.1/3660	PMU to CRV1 power cable	
Communication cable	W111	CRV2	Switcher(From CRV2)	196.9/5000	CRV1 to Switch communication cable	
Power cable	W01	PMU_TO MBC1 INPUT L1 L2 N G	MBC1 MAIN INPUT L1 L2 N G	51.2/1300	PMU to MBC1 power cable (MBC1 input)	
Power cable	W02	PMU_TO MBC2 INPUT L1 L2 N G	MBC2 MAIN INPUT L1 L2 N G	27.6/700	PMU to MBC2 power cable (MBC2 input)	

SHEET NO. 4 / 15	DRAWN BY: Nilesh Patil	DWG NO. SR2N04020PAA1	 <b>VERTIV™</b>
	APPROVED BY: Jakub Fencl		
CHANGE NO.	© 2020 VERTIV GROUP CORPORATION. CONFIDENTIAL AND PROPRIETARY. ALL RIGHTS RESERVED. VERTIV AND THE VERTIV LOGO ARE TRADEMARKS OR REGISTERED TRADEMARKS OF VERTIV GROUP CORPORATION. THIS DOCUMENT (AND THE INFORMATION IT CONTAINS) IS THE PROPERTY OF VERTIV GROUP CORPORATION. BY ACCEPTING IT INTO YOUR POSSESSION, YOU AGREE THAT YOU WILL KEEP THIS DOCUMENT AND ALL INFORMATION CONTAINED HEREIN IN STRICTEST CONFIDENCE AND WILL NOT DISCLOSE IT TO ANY OTHER PARTY WITHOUT THE WRITTEN PERMISSION OF VERTIV GROUP CORPORATION. YOU WILL BE RESPONSIBLE FOR THE PROPER DISPOSE OF SAME, DIRECTLY OR INDIRECTLY, WITHOUT THE EXPRESS WRITTEN PERMISSION OF VERTIV GROUP CORPORATION, AND THIS DOCUMENT SHALL BE RETURNED TO VERTIV GROUP CORPORATION IMMEDIATELY UPON REQUEST.		
PAGE DESCRIPTION: 3- Cable overview : =vRow+RACK1-W218 - =vRow+14PMU-W02	TITLE / DESCRIPTION: Vertiv™ SmartRow™ 2: 4x IT Rack 20KW		



## Cable overview

Packaging No.	Cable Category	Cable No.	Tag1	Tag2	Length (inch/mm)	Description
0411A860	Power cable	W03	PMU_TO MBC1 OUTPUT L1 L2 N	MBC1 MAIN OUTPUT L1 L2 N	76.8/1950	MBC1 to PMU power cable (MBC1 output)
	Power cable	W04	PMU_TO MBC2 OUTPUT L1 L2 N	MBC2 MAIN OUTPUT L1 L2 N	45.3/1150	MBC2 to PMU power cable (MBC2 output)
	Power cable	W05	MBC1_TO UPS1 INPUT L1 L2 N G	UPS1 INPUT L1 L2 N G	39.4/1000	MBC1 to UPS1 power cable (UPS1 input)
	Power cable	W06	MBC2_TO UPS2 INPUT L1 L2 N G	UPS2 INPUT L1 L2 N G	39.4/1000	MBC2 to UPS2 power cable (UPS2 input)
	Power cable	W07	UPS1 OUTPUT L1 L2 N G	MBC1_FROM UPS1 O/P L1 L2 N G	39.4/1000	UPS1 to MBC1 power cable (UPS1 output)
	Power cable	W08	UPS2 OUTPUT L1 L2 N G	MBC2_FROM UPS2 O/P L1 L2 N G	39.4/1000	UPS2 to MBC2 power cable (UPS2 output)
	Power cable	W09	PMU TO Extender1 L1 L2 N G	-	102.4/2600	PMU to Extender1 power cable
	Power cable	W10	PMU TO Extender2 L1 L2 N G	-	102.4/2600	PMU to Extender2 power cable
	Communication cable	W112	UPS1	Switcher(From UPS1)	177.2/4500	UPS 1 to Switch communication cable
	Communication cable	W113	UPS2	Switcher(From UPS2)	165.4/4200	UPS 2 to Switch communication cable
IT Rack-Factory Assembled	Communication cable	W118	NVR	Switcher(From NVR)	47.2/1200	NVR to Switch Communication Cable
	Smart door lock cascade (Factory assembled)	W206/W207	I-LOCK	F-R/BK W206, R-R/BK W207	82.7/2100	Smart door lock cable from rear door to front door in RACK1
	Smart door lock cascade (Factory assembled)	W206/W207	I-LOCK	F-R/BK W206, R-R/BK W207	82.7/2100	Smart door lock cable from rear door to front door in RACK2
	Smart door lock cascade (Factory assembled)	W206/W207	I-LOCK	F-R/BK W206, R-R/BK W207	82.7/2100	Smart door lock cable from rear door to front door in RACK3
	Smart door lock cascade (Factory assembled)	W206/W207	I-LOCK	F-R/BK W206, R-R/BK W207	82.7/2100	Smart door lock cable from rear door to front door in RACK4
	THD cascading pre-installed on the front door	W208	RACK-THD-RJ2	RACK-THD-RJ1	25.59/650	PMC to RACK1 Cascade Cable
	THD cascading pre-installed on the front door	W208	RACK-THD-RJ2	RACK-THD-RJ1	25.59/650	RACK1 to RACK2 Cascade Cable
	THD cascading pre-installed on the front door	W208	RACK-THD-RJ2	RACK-THD-RJ1	25.59/650	RACK2 to RACK3 Cascade Cable
	THD cascading pre-installed on the front door	W208	RACK-THD-RJ2	RACK-THD-RJ1	25.59/650	RACK3 to RACK4 Cascade Cable
	RACK1 Integrated front doors cable	W300	RACK_F-SW	RACK_F-SW	25.6/650	RACK1 cascade cables for front door microswitches
RACK1 Integrated front doors cable	W300	RACK_LOCK	RACK_LOCK	25.6/650	RACK1 F-Door communication cascade cable	
RACK1 Integrated rear doors cable	W301	RACK_LOCK	RACK_LOCK	25.6/650	RACK1 R-Door communication cascade cable	
RACK1 Integrated rear doors cable	W301	RACK_RLRIGHT	RACK_RLRIGHT	25.6/650	RACK1 rear door LED light cascade cable	
RACK1 Integrated rear doors cable	W301	RACK_R-SW	RACK_R-SW	25.6/650	RACK1 Cascade cables for rear door microswitches	
RACK1 Integrated rear doors cable	W301	I-LOCK	I-LOCK	25.6/650	RACK1 R-Door power cascade cable	
RACK2 Integrated front doors cable	W300	RACK_FLIGHT	RACK_FLIGHT	25.6/650	RACK2 front door LED light cascade cable	
RACK2 Integrated front doors cable	W300	RACK_F-SW	RACK_F-SW	25.6/650	RACK2 cascade cables for front door microswitches	

SHEET NO. 5 / 15	DRAWN BY: Nilesh Patil	DWG NO. SR2N04020PAA1	 <b>VERTIV™</b>
CHANGE NO.	APPROVED BY: Jakub Fenc	DATE (LATEST REV.) 21.08.2024	
PAGE DESCRIPTION: 3.a- Cable overview : =vRow+14PMU-W03 - =vRow+RACKF2.3-W300		REVISION: 505 N. CLEVELAND AVE WESTERVILLE OH 43081	
<small>© 2020 VERTIV GROUP CORPORATION CONFIDENTIAL AND PROPRIETARY. ALL RIGHTS RESERVED. VERTIV AND THE VERTIV LOGO ARE REGISTERED TRADEMARKS OF VERTIV GROUP CORPORATION. THIS DOCUMENT (AND THE INFORMATION IT CONTAINS) ARE THE PROPERTY OF VERTIV GROUP CORPORATION. BY ACCEPTING IT INTO YOUR POSSESSION, YOU AGREE THAT YOU WILL KEEP THIS DOCUMENT AND ALL INFORMATION CONTAINED HEREIN IN STRICTEST CONFIDENCE AND WILL NOT DISCLOSE IT TO ANY OTHER PARTY WITHOUT THE WRITTEN PERMISSION OF VERTIV GROUP CORPORATION. YOU WILL BE RESPONSIBLE FOR THE PROPER DISPOSE OF SAME, DIRECTLY OR INDIRECTLY, WITHOUT THE EXPRESS WRITTEN PERMISSION OF VERTIV GROUP CORPORATION, AND THIS DOCUMENT SHALL BE RETURNED TO VERTIV GROUP CORPORATION IMMEDIATELY UPON REQUEST.</small>			
<b>TITLE / DESCRIPTION: Vertiv™ SmartRow™ 2: 4x IT Rack 20KW</b>			

## Cable overview

Packaging No.	Cable Category	Cable No.	Tag1	Tag2	Length (inch/mm)	Description
IT Rack-Factory Assembled	RACK2 Integrated front doors cable	W300	RACK_LOCK	RACK_LOCK	25.6/650	RACK2 F-Door communication cascade cable
	RACK2 Integrated rear doors cable	W301	RACK_LOCK	RACK_LOCK	25.6/650	RACK2 R-Door communication cascade cable
	RACK2 Integrated rear doors cable	W301	RACK_RLIGHT	RACK_RLIGHT	25.6/650	RACK2 rear door LED light cascade cable
	RACK2 Integrated rear doors cable	W301	RACK_R-SW	RACK_R-SW	25.6/650	RACK2 Cascade cables for rear door microswitches
	RACK2 Integrated rear doors cable	W301	I-LOCK	I-LOCK	25.6/650	RACK2 R-Door power cascade cable
	RACK3 Integrated front doors cable	W300	RACK_FLIGHT	RACK_FLIGHT	25.6/650	RACK3 front door LED light cascade cable
	RACK3 Integrated front doors cable	W300	RACK_F-SW	RACK_F-SW	25.6/650	RACK3 cascade cables for front door microswitches
	RACK3 Integrated front doors cable	W300	RACK_LOCK	RACK_LOCK	25.6/650	RACK3 F-Door communication cascade cable
	RACK3 Integrated rear doors cable	W301	RACK_LOCK	RACK_LOCK	25.6/650	RACK3 R-Door communication cascade cable
	RACK3 Integrated rear doors cable	W301	RACK_RLIGHT	RACK_RLIGHT	25.6/650	RACK3 rear door LED light cascade cable
	RACK3 Integrated rear doors cable	W301	RACK_R-SW	RACK_R-SW	25.6/650	RACK3 cascade cables for rear door microswitches
	RACK3 Integrated rear doors cable	W301	I-LOCK	I-LOCK	25.6/650	RACK3 R-Door power cascade cable
	RACK4 Integrated front doors cable	W300	RACK_FLIGHT	RACK_FLIGHT	25.6/650	RACK4 front door LED light cascade cable
	RACK4 Integrated front doors cable	W300	RACK_F-SW	RACK_F-SW	25.6/650	RACK4 cascade cables for front door microswitches
	RACK4 Integrated front doors cable	W300	RACK_LOCK	RACK_LOCK	25.6/650	RACK4 F-Door communication cascade cable
	RACK4 Integrated rear doors cable	W301	RACK_LOCK	RACK_LOCK	25.6/650	RACK4 R-Door communication cascade cable
	RACK4 Integrated rear doors cable	W301	I-LOCK	I-LOCK	25.6/650	RACK4 R-Door power cascade cable
	RACK4 Integrated rear doors cable	W301	RACK_R-SW	RACK_R-SW	25.6/650	RACK4 Cascade cables for rear door microswitches
	RACK4 Integrated rear doors cable	W301	RACK_RLIGHT	RACK_RLIGHT	25.6/650	RACK4 rear door LED light cascade cable
	PMC-Factory Assembled	Power cable (Factory assembled)	W14	PMU-RLIGHT DC+ DC-	PMC-RLIGHT	47.2/1200
Power cable (Factory assembled)		W16	PMU-FLIGHT FWH FRE FBK FBL	PMC-FLIGHT	68.9/1750	PMU to PMC front door LED light power cable
Power cable (Factory assembled)		W18	PMU-F-SW FCOM FNC	PMC-F-SW	49.2/1250	PMU to PMC front door microswitch power cable
Power cable (Factory assembled)		W19	PMU-R-SW RCOM RNC	PMC-R-SW	49.2/1250	PMU to PMC rear door microswitch power cable
Power cable (Factory assembled)	W13	PMU-LOCK DC+ DC-	PMC-LOCK	53.1/1350	PMU to PMC/CRV1/RACK1 intelligent door lock power cable	
Communication cable (factory assembled)	W101	PMC-FLOCK	8COM-COM1	35.4/900	PMC to RDU501_ COM1 intelligent door lock front door communication cable	
Communication cable (factory assembled)	W107	PMU-RLOCK	8COM-COM2	70.9/1800	PMC to RDU501_ COM2 intelligent door lock rear door communication cable	
Smart door lock cascade (Factory assembled)	W206/W207	I-LOCK	F-R/BK W206, R-R/BK W207	82.7/2100	Smart door lock cable from rear door to front door in PMC	

SHEET NO. 6 / 15	DRAWN BY: Nilesh Patil	DWG NO. SR2N04020PAA1	 <b>VERTIV</b> <sup>TM</sup>
CHANGE NO.	APPROVED BY: Jakub Fenc	DATE (LATEST REV.) 21.08.2024	
PAGE DESCRIPTION: 3.b- Cable overview : =vRow+RACKF2.1-W300 - =vRow+10PMC-W206/W207		REVISION: 505 N. CLEVELAND AVE WESTERVILLE OH 43081	

## Cable overview

Packaging No.	Cable Category	Cable No.	Tag1	Tag2	Length (inch/mm)	Description
PMC-Factory Assembled	Communication cable (factory assembled)	W109	RDU501-Sensor1	THD-RJ1	27.6/700	RDU501 to PMC cabinet THD communication cable
	Power cable (Factory assembled)	W15	HMI-P	PMU-HMI DC+ DC-	59.1/1500	PMU to HMI power cable
	Communication cable (factory assembled)	W102	PMU-DO2	RDU501-DO2	70.9/1800	PMU to RDU501 DO2 Control Red Light Cable
	Communication cable (factory assembled)	W104	PMU-DI	4DI-RJ451	66.9/1700	PMU to 4DI SPD communication network cable
	Communication cable (factory assembled)	W105	PMU-RS485	RDU501-COM3	70.9/1800	PMU to RDU501 COM3 meter communication network cable
	Communication cable (factory assembled)	W106	4DI-DI1	RDU501-Sensor2	11.8/300	4DI to RDU501 Smoke 2 SPD Communication Network Cable
	Communication cable (factory assembled)	W108	RDU501-COM2	HMI-C	29.5/750	RDU501 COM2 to HMI communication cable

<b>SHEET NO.</b>	7 / 15	<b>DRAWN BY:</b>	Nilesh Patil	<b>DWG NO.</b>	SR2N04020PAA1
<b>CHANGE NO.</b>		<b>APPROVED BY:</b>	Jakub Fencel	<b>DATE (LATEST REV.)</b>	21.08.2024
<b>PAGE DESCRIPTION:</b>	3.c- Cable overview : =vRow+12PMC-W109 - =vRow+16PMU-W108		<b>REVISION:</b> 505 N. CLEVELAND AVE WESTERVILLE OH 43081		
<b>TITLE / DESCRIPTION:</b> Vertiv™ SmartRow™ 2: 4x IT Rack 20KW				 <b>VERTIV™</b>	

© 2020 VERTIV GROUP CORPORATION. CONFIDENTIAL AND PROPRIETARY. ALL RIGHTS RESERVED. VERTIV AND THE VERTIV LOGO ARE TRADEMARKS OR REGISTERED TRADEMARKS OF VERTIV GROUP CORPORATION. THIS DOCUMENT (AND THE INFORMATION IT CONTAINS) ARE THE PROPERTY OF VERTIV GROUP CORPORATION BY ACCEPTING IT INTO YOUR POSSESSION, YOU AGREE THAT YOU WILL KEEP THIS DOCUMENT AND ALL INFORMATION CONTAINED HEREIN IN STRICTEST CONFIDENCE AND WILL NOT DISCLOSE IT TO ANY OTHER PARTY WITHOUT THE EXPRESS WRITTEN PERMISSION OF VERTIV GROUP CORPORATION. YOU WILL NOT REPRODUCE, COPY, REPRODUCE, TRANSMIT, SELL, LEASE, OR OTHERWISE DISPOSE OF SAME, DIRECTLY OR INDIRECTLY, WITHOUT THE EXPRESS WRITTEN PERMISSION OF VERTIV GROUP CORPORATION, AND THIS DOCUMENT SHALL BE RETURNED TO VERTIV GROUP CORPORATION IMMEDIATELY UPON REQUEST.

# FC & Geist PDUs -SR2 for 20K( 4\*ITRack)

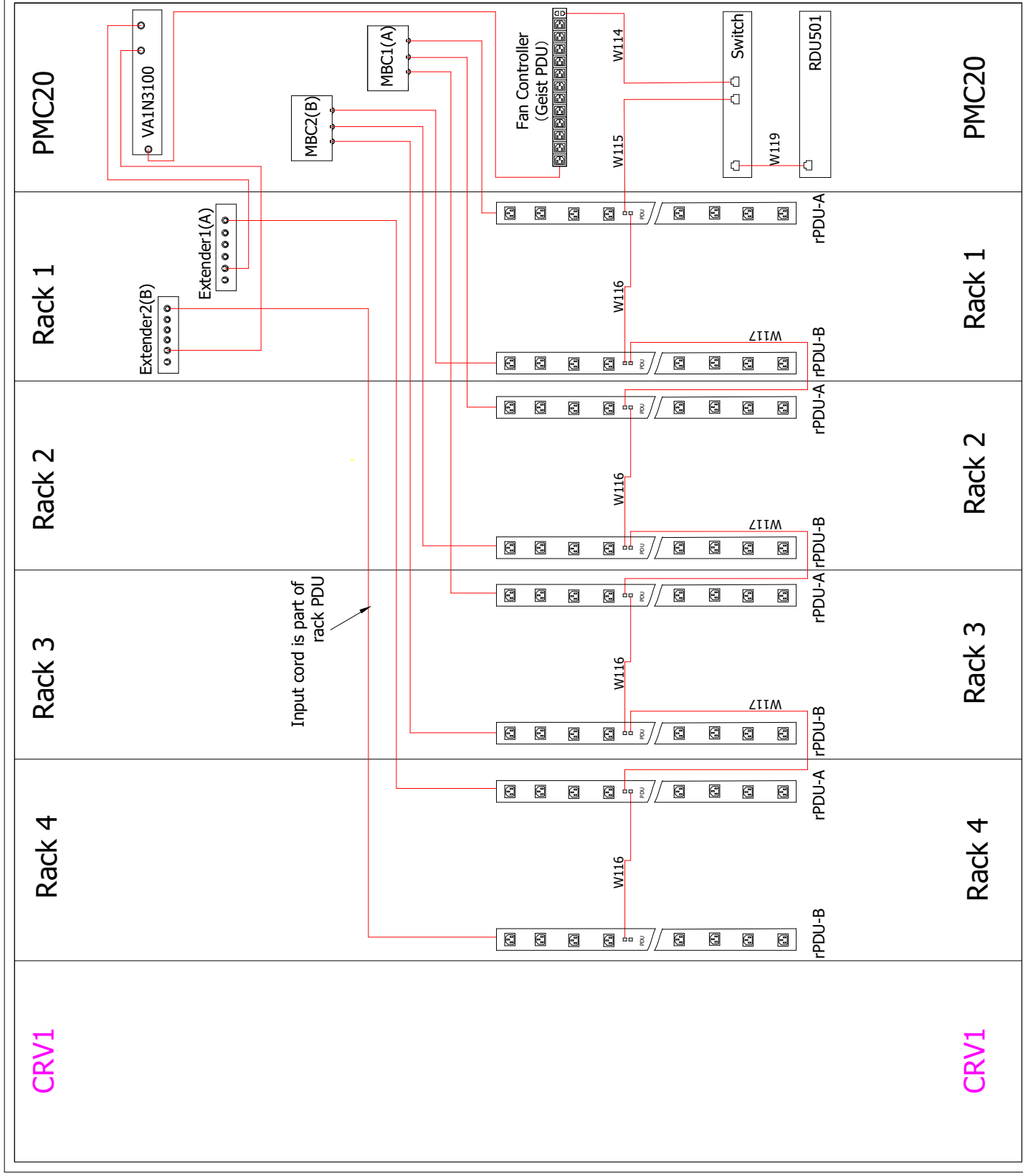

--- Factory connected cables  
 --- Cables connected at assembly

SHEET NO. 8 / 15	DRAWN BY: Nilesh Patil	DWG NO. SR2N04020PAA1	
CHANGE NO.	APPROVED BY: Jakub Fenc	DATE (LATEST REV.) 21.08.2024	
PAGE DESCRIPTION: 4- PDU wiring diagram	TITLE / DESCRIPTION: Vertiv™ SmartRow™ 2: 4x IT Rack 20kW		REVISION: 505 N. CLEVELAND AVE WESTERVILLE OH 43081



### CRVs(CR019)-SR2 for 20K (4\*ITRack)

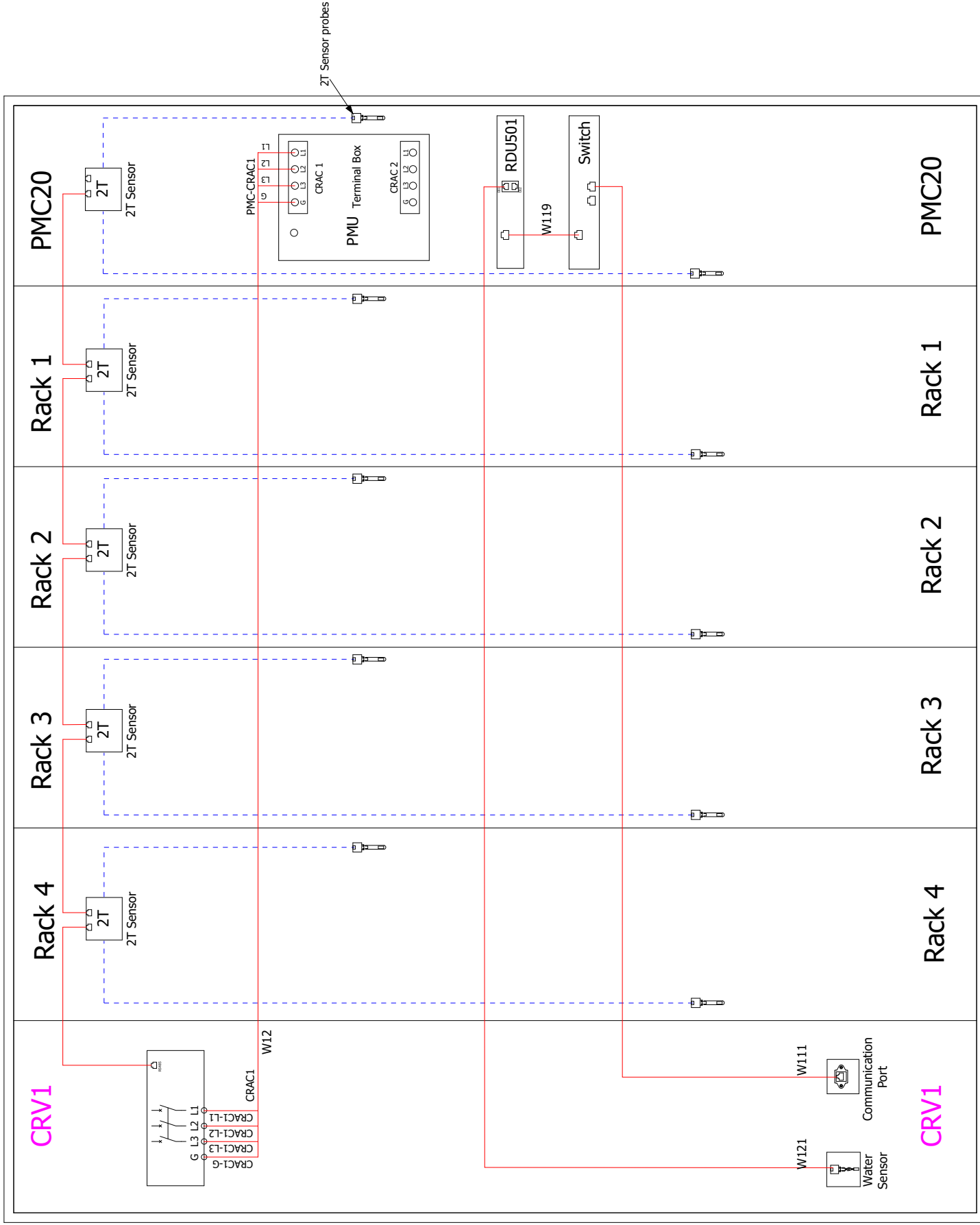

--- Factory connected cables  
 - - - Cables connected at assembly

SHEET NO.	9 / 15	DRAWN BY:	Nilesh Patil	DWG NO.	SR2N04020PAA1
CHANGE NO.		APPROVED BY:	Jakub Fenc	DATE (LATEST REV.)	21.08.2024
PAGE DESCRIPTION:	4.a- Air conditioner wiring diagram	REVISION:			
			505 N. CLEVELAND AVE WESTERVILLE OH 43081		
© 2020 VERTIV GROUP CORPORATION. CONFIDENTIAL AND PROPRIETARY. ALL RIGHTS RESERVED. VERTIV AND THE VERTIV LOGO ARE TRADEMARKS OR REGISTERED TRADEMARKS OF VERTIV GROUP CORPORATION. THIS DOCUMENT IS THE PROPERTY OF VERTIV GROUP CORPORATION. IT IS TO BE USED ONLY FOR THE BENEFIT OF VERTIV GROUP CORPORATION. IT IS NOT TO BE REPRODUCED, COPIED, OR OTHERWISE DISPOSED OF IN ANY MANNER WITHOUT THE EXPRESS WRITTEN PERMISSION OF VERTIV GROUP CORPORATION. AND THIS DOCUMENT SHALL BE RETURNED TO VERTIV GROUP CORPORATION IMMEDIATELY UPON REQUEST.					
TITLE / DESCRIPTION: Vertiv™ SmartRow™ 2: 4x IT Rack 20kW					

# Intelligent Locks -SR2 for 20K(Max 4\*ITrack)

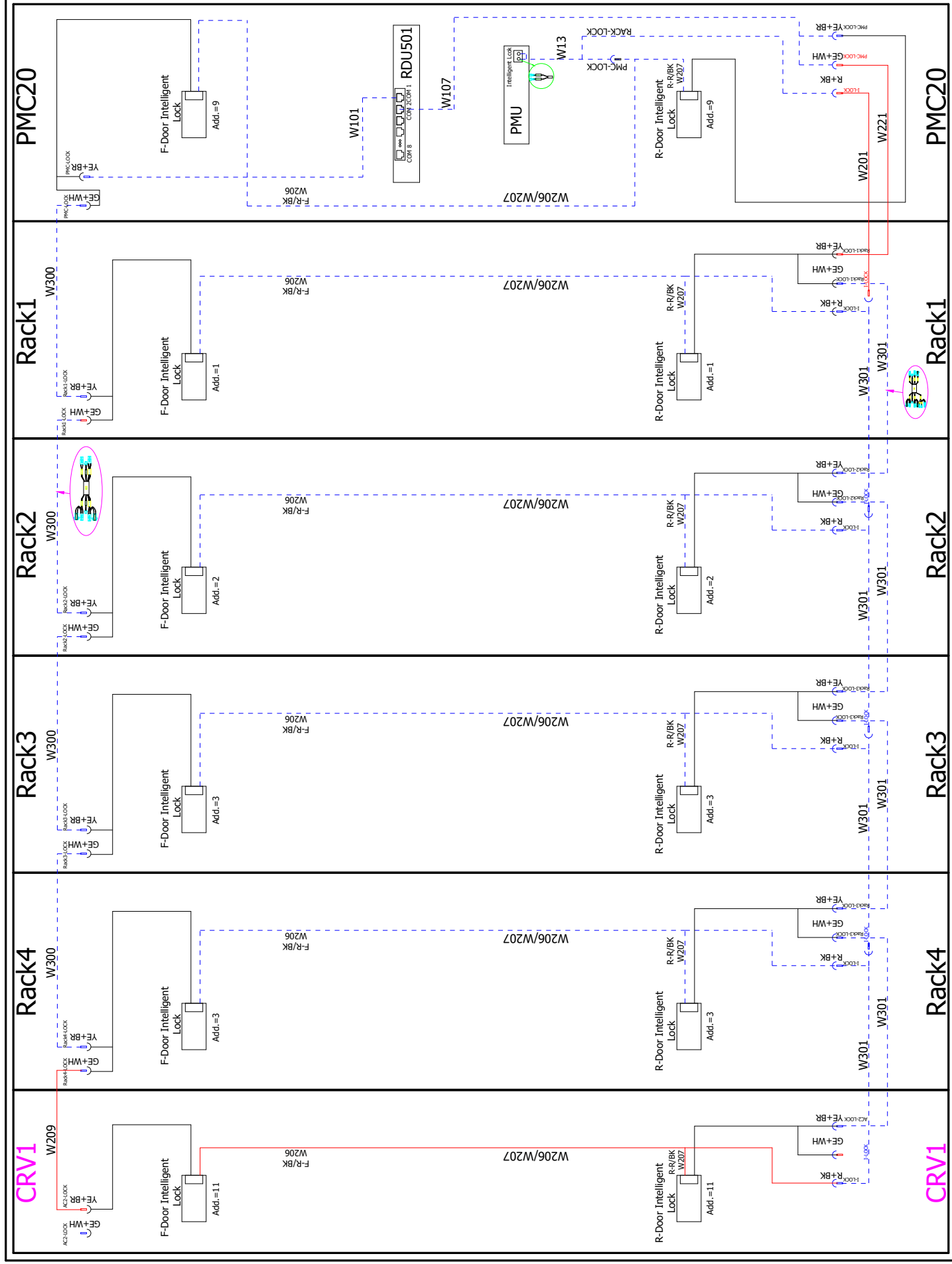

--- Factory connected cables  
 — Cables connected at assembly

SHEET NO. 10 / 15	DRAWN BY: Nilesh Patil	DWG NO. SR2N04020PAA1	DATE (LATEST REV.) 21.08.2024	
			REVISION: 505 N. CLEVELAND AVE WESTERVILLE OH 45081	
CHANGE NO.	APPROVED BY: Jakub Fend	TITLE / DESCRIPTION: Vertiv™ SmartRow™ 2: 4x IT Rack 20kW		
PAGE DESCRIPTION: 4.b- Intelligent lock wiring diagram	© 2020 VERTIV GROUP CORPORATION. CONFIDENTIAL AND PROPRIETARY. ALL RIGHTS RESERVED. VERTIV AND THE VERTIV LOGO ARE TRADEMARKS OR REGISTERED TRADEMARKS OF VERTIV GROUP CORPORATION. THIS DOCUMENT (AND THE INFORMATION IT CONTAINS) ARE THE PROPERTY OF VERTIV GROUP CORPORATION BY ACCEPTING IT INTO YOUR POSSESSION, YOU AGREE THAT YOU WILL KEEP THIS DOCUMENT AND INFORMATION CONFIDENTIAL AND NOT DISCLOSE IT TO ANY OTHER PARTY WITHOUT THE EXPRESS WRITTEN PERMISSION OF VERTIV GROUP CORPORATION, AND THIS DOCUMENT SHALL BE RETURNED TO VERTIV GROUP CORPORATION IMMEDIATELY UPON REQUEST.			

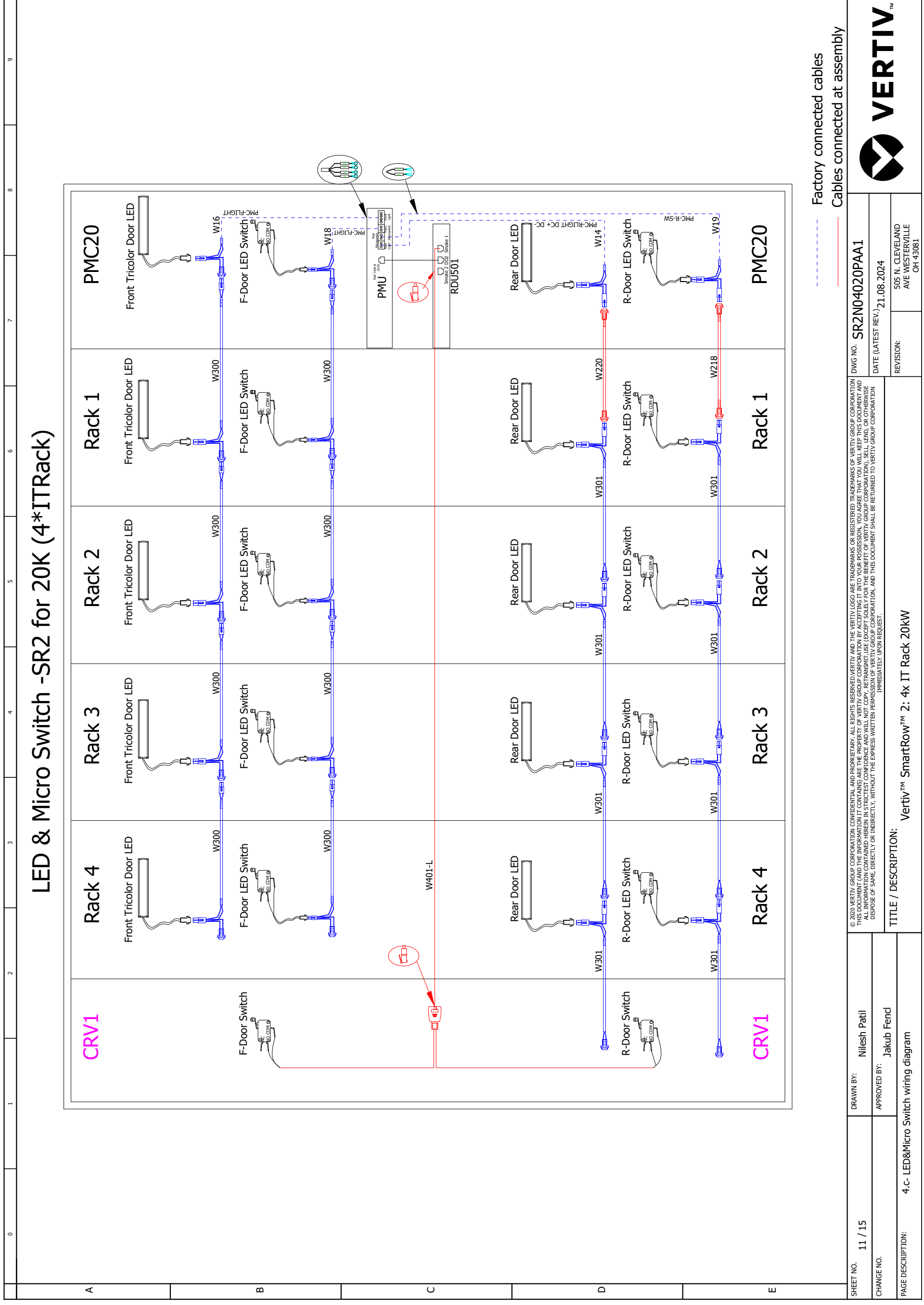

Factory connected cables  
 Cables connected at assembly

SHEET NO. 11 / 15	DRAWN BY: Nilesh Patil	DWG NO. SR2N04020PAA1	
CHANGE NO.	APPROVED BY: Jakub Fencel	DATE (LATEST REV.) 21.08.2024	
PAGE DESCRIPTION: 4.-c- LED&Micro Switch wiring diagram	REVISION: 505 N. CLEVELAND AVE WESTERVILLE OH 43081		

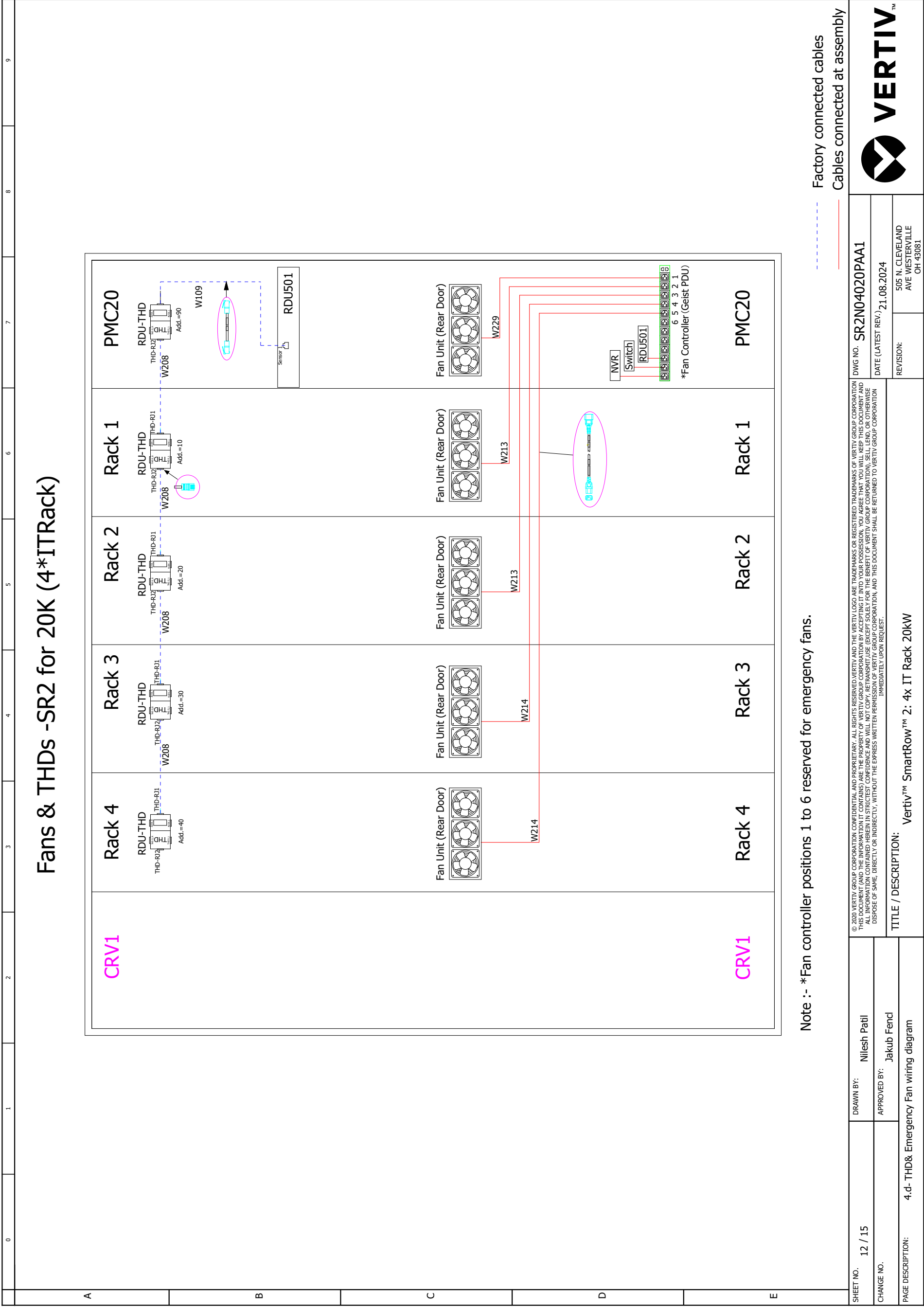



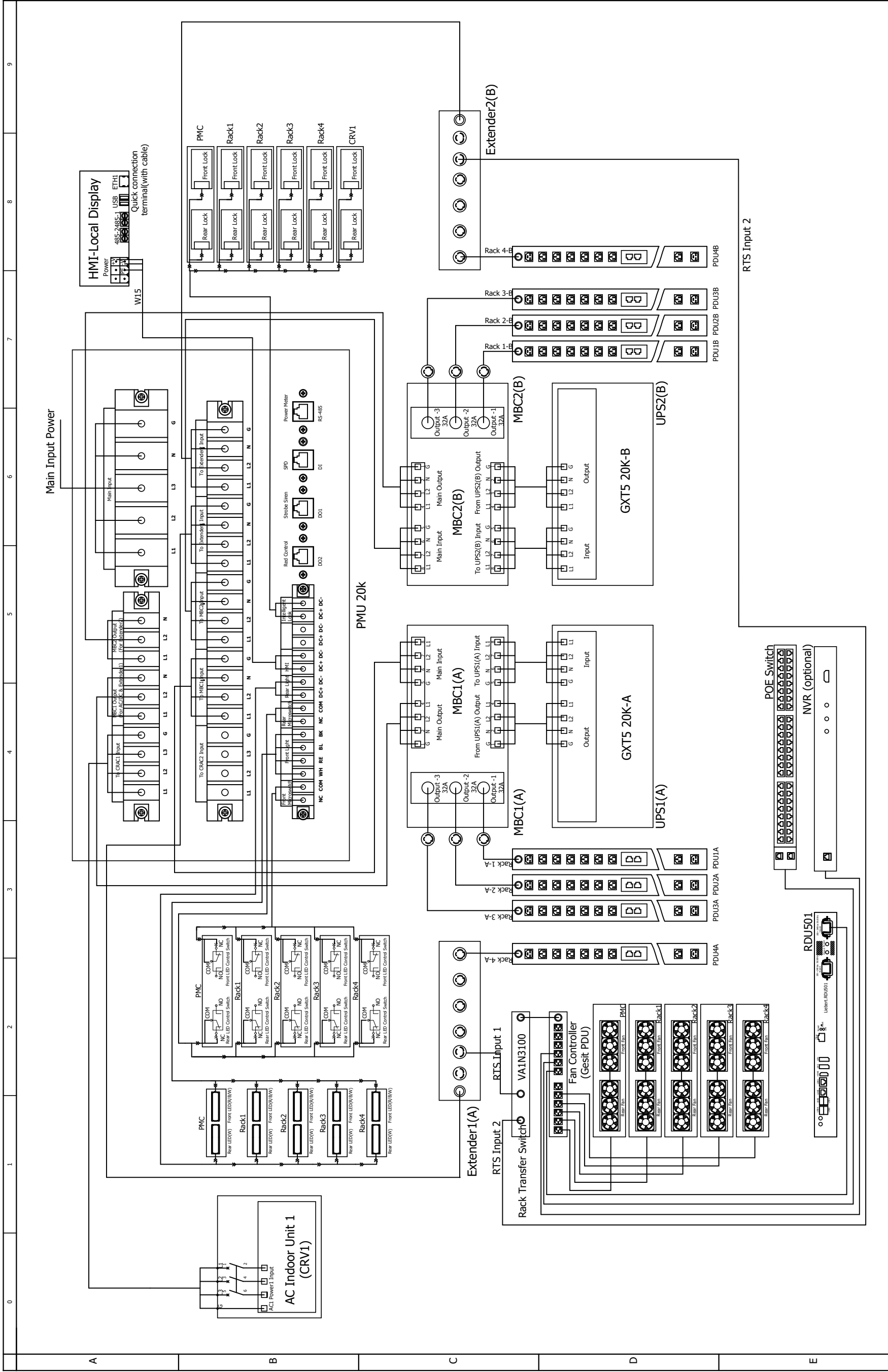

SHEET NO. 13 / 15	DRAWN BY: Nilesh Patil	DWG NO. SR2N04020PAA1	
CHANGE NO.	APPROVED BY: Jakub Fenc	DATE (LATEST REV.) 21.08.2024	
PAGE DESCRIPTION: 5- 20k Power single line diagram	TITLE / DESCRIPTION: Vertiv™ SmartRow™ 2: 4x IT Rack 20KW		REVISION: 505 N. CLEVELAND AVE WESTERVILLE OH 43081

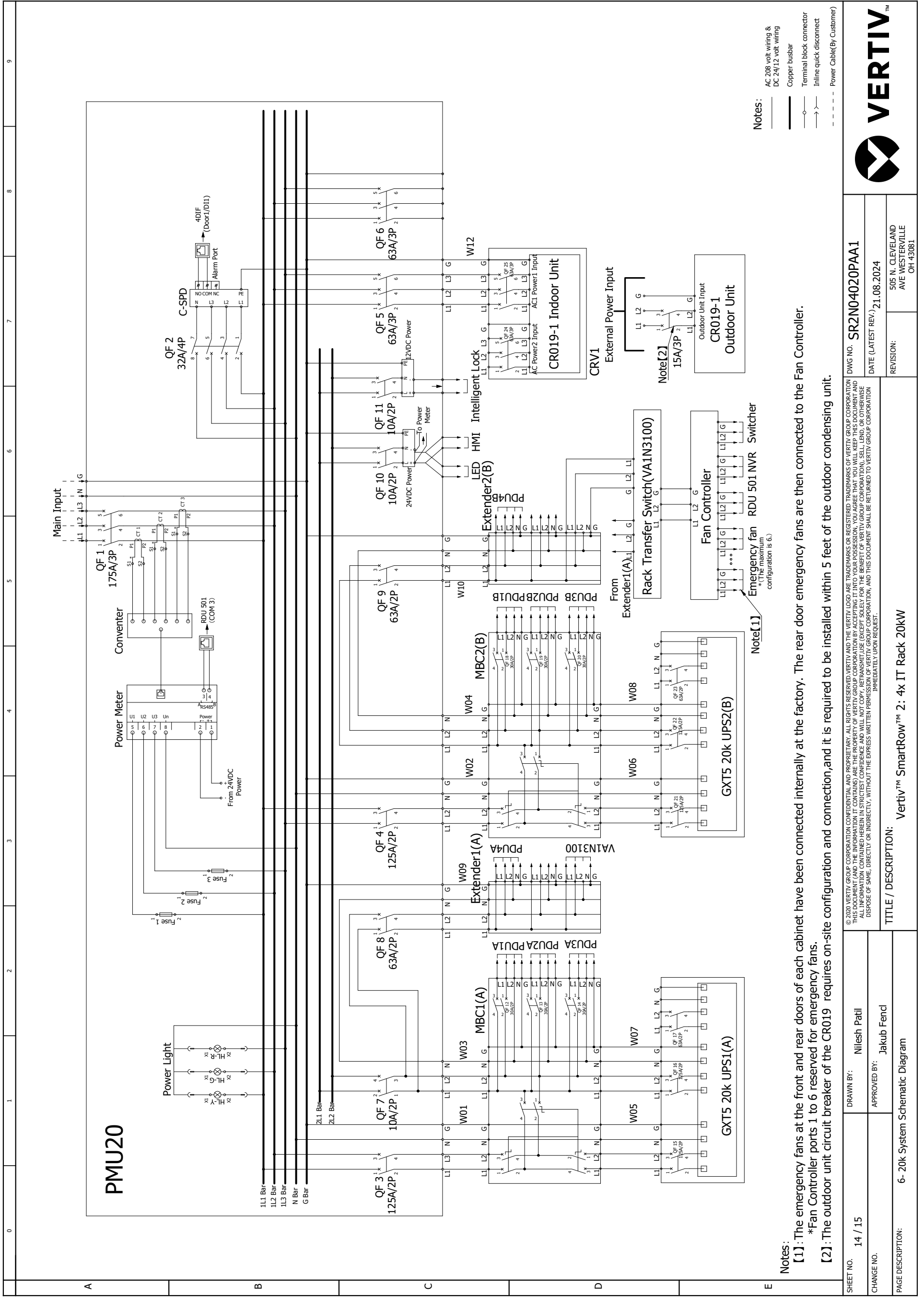

- Notes:
- AC 208 volt wiring & DC 24/12 volt wiring
  - Copper busbar
  - Terminal block connector
  - Inline quick disconnect
  - Power Cable(By Customer)

Notes:  
 [1]: The emergency fans at the front and rear doors of each cabinet have been connected internally at the factory. The rear door emergency fans are then connected to the Fan Controller.  
 \*Fan Controller ports 1 to 6 reserved for emergency fans.  
 [2]: The outdoor unit circuit breaker of the CR019 requires on-site configuration and connection, and it is required to be installed within 5 feet of the outdoor condensing unit.

SHEET NO.	14 / 15	DRAWN BY:	Nilesh Patil	DWG NO.	SR2N04020PAA1
CHANGE NO.		APPROVED BY:	Jakub Fend	DATE (LATEST REV.)	21.08.2024
PAGE DESCRIPTION:	6- 20k System Schematic Diagram			REVISION:	505 N. CLEVELAND AVE WESTERVILLE OH 43081
TITLE / DESCRIPTION: Vertiv™ SmartRow™ 2: 4x IT Rack 20kW					
<small>© 2020 VERTIV GROUP CORPORATION CONFIDENTIAL AND PROPRIETARY. ALL RIGHTS RESERVED. VERTIV AND THE VERTIV LOGO ARE TRADEMARKS OR REGISTERED TRADEMARKS OF VERTIV GROUP CORPORATION THIS DOCUMENT (AND THE INFORMATION IT CONTAINS) ARE THE PROPERTY OF VERTIV GROUP CORPORATION BY ACCEPTING IT INTO YOUR POSSESSION, YOU AGREE THAT YOU WILL KEEP THIS DOCUMENT AND ALL INFORMATION CONTAINED HEREIN STRICTLY CONFIDENTIAL AND WILL NOT DISCLOSE OR REPRODUCE IT IN ANY MANNER WITHOUT THE EXPRESS WRITTEN PERMISSION OF VERTIV GROUP CORPORATION. DISPOSE OF SAME, DIRECTLY OR INDIRECTLY, WITHOUT THE EXPRESS WRITTEN PERMISSION OF VERTIV GROUP CORPORATION, AND THIS DOCUMENT SHALL BE RETURNED TO VERTIV GROUP CORPORATION IMMEDIATELY UPON REQUEST.</small>					

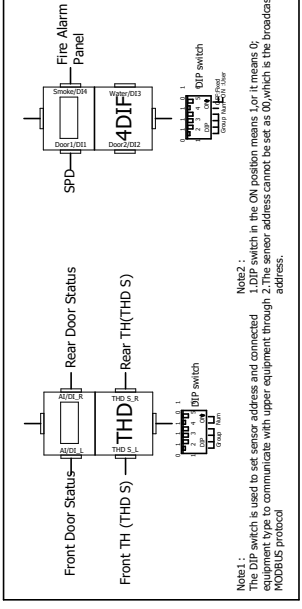
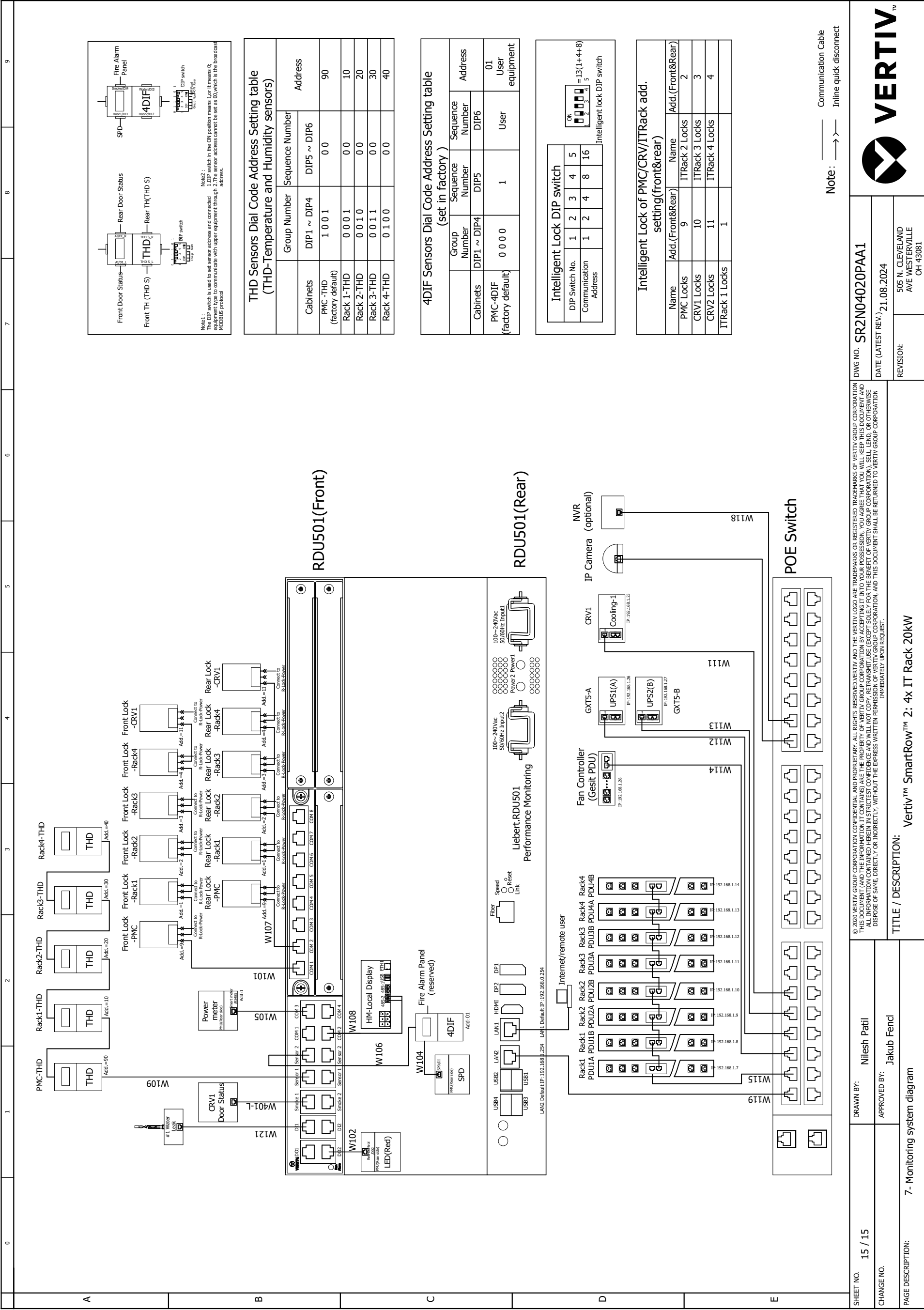

THD Sensors Dial Code Address Setting table (THD-Temperature and Humidity sensors)

Cabinets	Group Number	Sequence Number	Address
PMC-THD (factory default)	DIP1 ~ DIP4	DIP5 ~ DIP6	90
Rack 1-THD	0 0 0 1	0 0	10
Rack 2-THD	0 0 1 0	0 0	20
Rack 3-THD	0 0 1 1	0 0	30
Rack 4-THD	0 1 0 0	0 0	40

4DIF Sensors Dial Code Address Setting table (set in factory)

Group Number	Sequence Number	Address
DIP1 ~ DIP4	DIP5	DIP6
0 0 0 0	1	User equipment
0 0 0 0	16	01 User equipment

Intelligent Lock DIP switch

DIP Switch No.	Address
1	2
2	3
3	4
4	8
5	16

ON = 13(1+4+8)

Intelligent Lock of PMC/CRV/ITRack add. setting(front&rear)

Name	Addr.(Front&Rear)	Name	Addr.(Front&Rear)
PMC Locks	9	ITRack 2 Locks	2
CRV1 Locks	10	ITRack 3 Locks	3
CRV2 Locks	11	ITRack 4 Locks	4
ITRack 1 Locks	1		

Note:  $\text{---} \rightarrow \text{---}$  Communication Cable  
 $\text{---} \rightarrow \text{---}$  Inline quick disconnect

SHEET NO. 15 / 15  
DRAWN BY: Nilesh Patil  
APPROVED BY: Jakub Fenc  
PAGE DESCRIPTION: 7 - Monitoring system diagram

DWG NO. SR2N04020PAA1  
DATE (LATEST REV.): 21.08.2024  
REVISION: 505 N. CLEVELAND AVE WESTERVILLE OH 43081



TITLE / DESCRIPTION: Vertiv SmartRow™ 2: 4x IT Rack 20KW

© 2020 VERTIV GROUP CORPORATION. CONFIDENTIAL AND PROPRIETARY. ALL RIGHTS RESERVED. VERTIV AND THE VERTIV LOGO ARE TRADEMARKS OR REGISTERED TRADEMARKS OF VERTIV GROUP CORPORATION. THIS DOCUMENT (AND THE INFORMATION IT CONTAINS) IS THE PROPERTY OF VERTIV GROUP CORPORATION. BY ACCEPTING IT INTO YOUR POSSESSION, YOU AGREE THAT YOU WILL KEEP THIS DOCUMENT AND ALL INFORMATION CONTAINED HEREIN IN STRICTEST CONFIDENCE AND WILL NOT DISCLOSE IT TO ANY OTHER PARTY WITHOUT THE EXPRESS WRITTEN PERMISSION OF VERTIV GROUP CORPORATION. YOU WILL IMMEDIATELY DISPOSE OF SAME, DIRECTLY OR INDIRECTLY, WITHOUT THE EXPRESS WRITTEN PERMISSION OF VERTIV GROUP CORPORATION, AND THIS DOCUMENT SHALL BE RETURNED TO VERTIV GROUP CORPORATION IMMEDIATELY UPON REQUEST.

## 4. Field Supplied Cable & Part List

0	1	2	3	4	5	6	7	8	9
<b>A</b>	<b>FIELD SUPPLIED CABLE &amp; PART LIST</b>								
<b>PART</b>	<b>DETAILS</b>								
CABbus cable (A)	2 conductors, 22-18AWG shielded cable								
HEAT REJECTION INTERLOCK (B)	2 conductors, 18AWG or greater								
CONDENSER INPUT POWER CABLE (C)	3 conductors + PE, 14 AWG copper cable								
CONDENSATE PUMP TUBE (D)	Used with 3/8 in. nylon adapter hose or 1/2 in. MPT x 3/8 in. hose barb threaded adapter								
<b>B</b>	<p>The diagram shows two units: CR019RA1Y7-SR2 (left) and MCM040E1YD-SR2 (right). Connection (A) is between terminals 49-1, 49-3, and SH of both units. Connection (B) is between terminals 70 and 71 of both units. Connection (C) is the POWER INPUT to the MCM040E1YD-SR2 unit. A note indicates 'To CRV2 port ETH2 teamwork connection' pointing to the ETH2 port on the CR019RA1Y7-SR2 unit.</p>								
<b>C</b>	CONNECTION DETAILS REFER TO DPN003036								
<b>D</b>	<p>Diagram (D) shows two parts: a hose barb (1) and a threaded adapter (2). A note says 'DETAILS REFER TO SL-11975'.</p>								
<b>E</b>	<p>© 2020 VERTIV GROUP CORPORATION. CONFIDENTIAL AND PROPRIETARY. ALL RIGHTS RESERVED. VERTIV AND THE VERTIV LOGO ARE TRADEMARKS OR REGISTERED TRADEMARKS OF VERTIV GROUP CORPORATION. THIS DOCUMENT (AND THE INFORMATION IT CONTAINS) ARE THE PROPERTY OF VERTIV GROUP CORPORATION BY ACCEPTING IT INTO YOUR POSSESSION, YOU AGREE THAT YOU WILL KEEP THIS DOCUMENT AND ALL INFORMATION CONTAINED HEREIN IN STRICTEST CONFIDENCE AND WILL NOT COPY, REPRODUCE, TRANSMIT, USE (EXCEPT SOLELY FOR THE BENEFIT OF VERTIV GROUP CORPORATION), SELL, LEND, OR OTHERWISE DISPOSE OF SAME, DIRECTLY OR INDIRECTLY, WITHOUT THE EXPRESS WRITTEN PERMISSION OF VERTIV GROUP CORPORATION. THIS DOCUMENT SHALL BE RETURNED TO VERTIV GROUP CORPORATION IMMEDIATELY UPON REQUEST.</p> <p><b>FIELD SUPPLIED CABLE &amp; PART LIST</b></p>								
SHEET NO.	1 / 1		DRAWN BY:	Petr Harant		DWG NO.			
CHANGE NO.			APPROVED BY:	Tomáš Krech		DATE (LATEST REV.)	30.05.2024		
PAGE DESCRIPTION:			REVISION:			505 N. CLEVELAND AVE. WESTERVILLE OH 43081			



# 5. Vertiv MSR2 600mm IT Rack

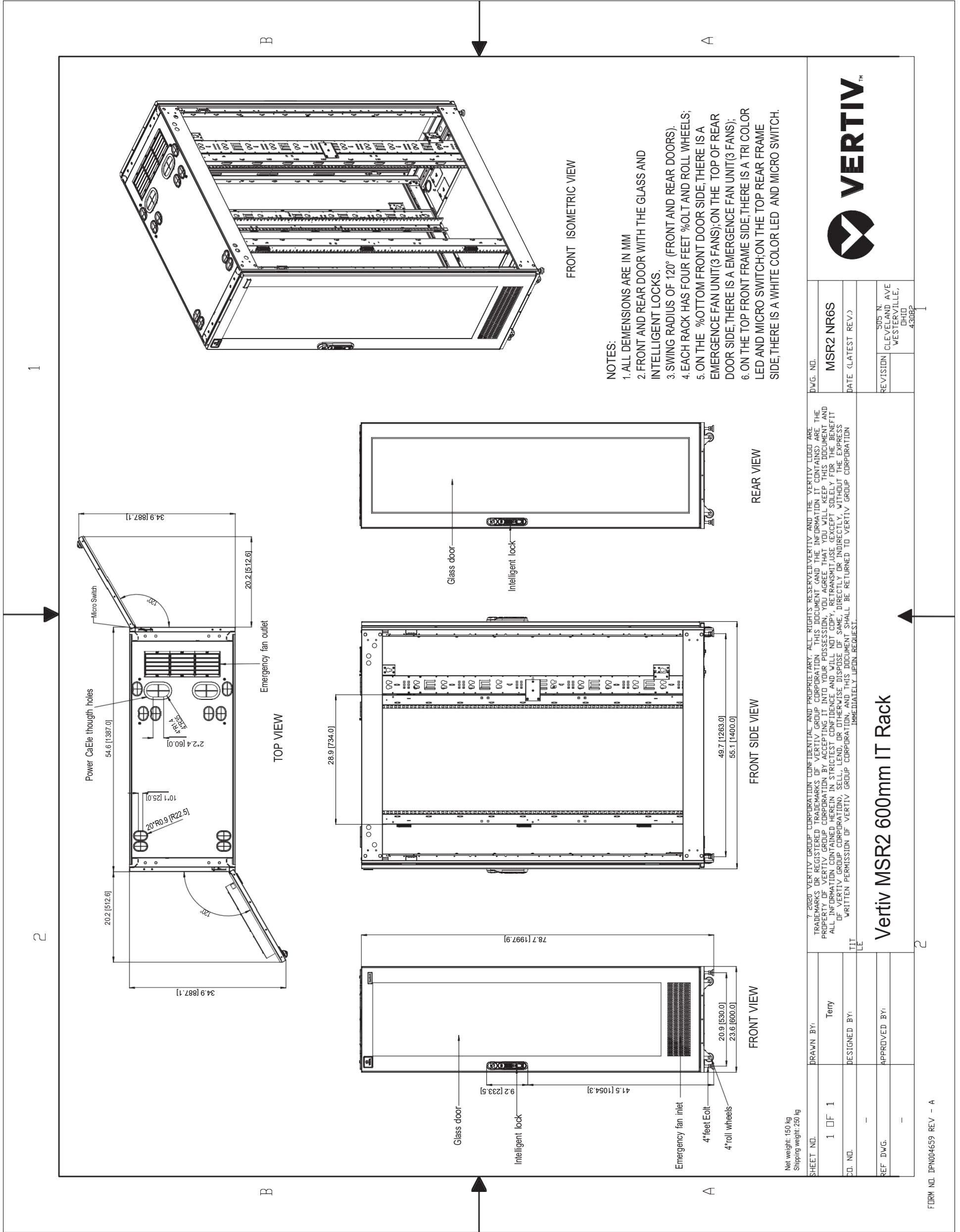

D.W.G. NO.		MSR2 NR6S	
DATE (LATEST REV.)			
REVISION	505 N. CLEVELAND AVE. WESTERVILLE, OHIO 43082		
© 2020 VERTIV GROUP CORPORATION CONFIDENTIAL AND PROPRIETARY. ALL RIGHTS RESERVED. VERTIV AND THE VERTIV LOGO ARE TRADEMARKS OR REGISTERED TRADEMARKS OF VERTIV GROUP CORPORATION. THIS DOCUMENT (AND THE INFORMATION IT CONTAINS) ARE THE PROPERTY OF VERTIV GROUP CORPORATION. BY ACCEPTING IT INTO YOUR POSSESSION, YOU AGREE THAT YOU WILL KEEP THIS DOCUMENT AND ALL INFORMATION CONTAINED HEREIN IN STRICTEST CONFIDENCE AND WILL NOT COPY, REPRODUCE, TRANSMIT, USE (EXCEPT SOLELY FOR THE BENEFIT OF VERTIV GROUP CORPORATION), SELL, LEND, OR OTHERWISE DISPOSE OF SAME, DIRECTLY OR INDIRECTLY, WITHOUT THE EXPRESS WRITTEN PERMISSION OF VERTIV GROUP CORPORATION, AND THIS DOCUMENT SHALL BE RETURNED TO VERTIV GROUP CORPORATION IMMEDIATELY UPON REQUEST.			
DRAWN BY: Terry		VERTIV™	
DESIGNED BY:			
APPROVED BY:			
SHEET NO. 1 OF 1		Vertiv MSR2 600mm IT Rack	
CD. NO.			
REF. D.W.G.			

Net weight: 150 kg  
 Shipping weight: 250 kg

## 6. Vertiv MSR2 Power Management Cabinet (PMC)

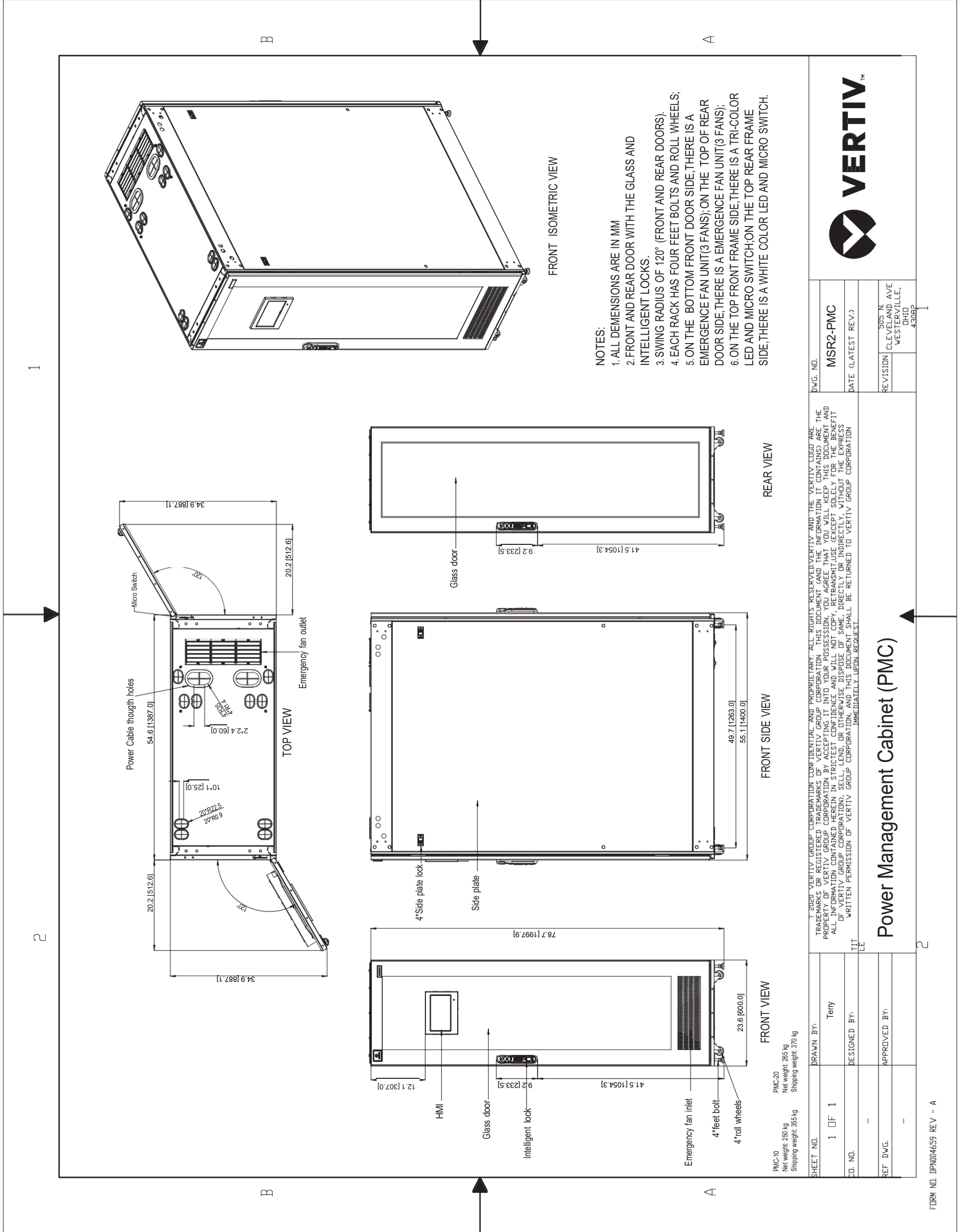

# 7. Vertiv Liebert CR019 with Plenums

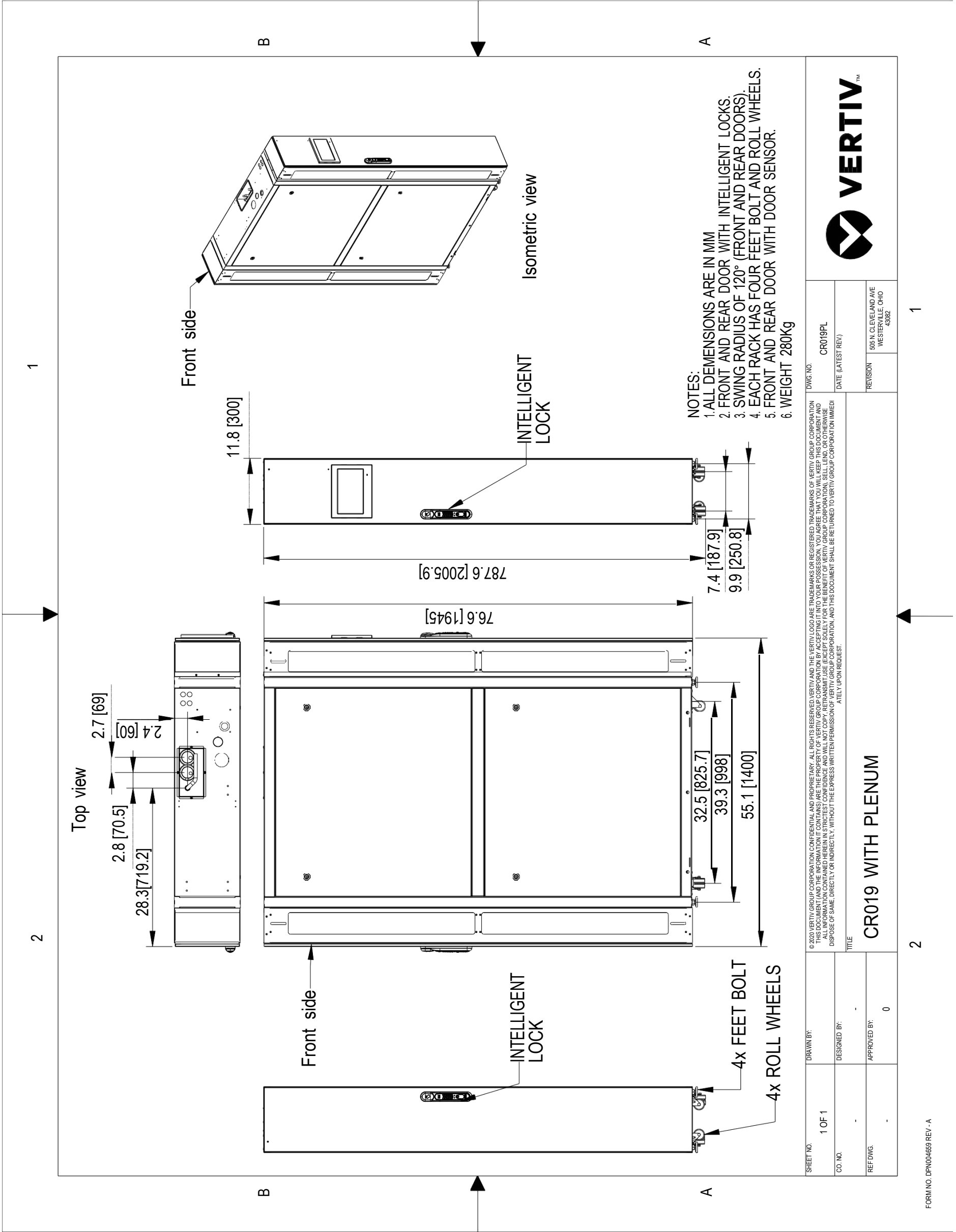

SHEET NO. 1 OF 1		DRAWN BY:		DWG. NO. CR019PL	
CO. NO.		DESIGNED BY:		DATE (LATEST REV.)	
REF. DWG.		APPROVED BY:		REVISION	
		0		905 N. CLEVELAND AVE WESTERVILLE, OHIO 43082	
TITLE CR019 WITH PLENUM					

# 8. Power Management Unit - 20kW (PMU20)

FRONT ISOMETRIC VIEW

23	GROUND SCREWS	1	REMARK
22	MAIN POWER TERMINAL BLOCKS	1	
21	POWER METER RS485(RJ45)	1	
20	SPD DI(RJ45)	1	
19	STOBE SIREN CONTROL DO1(RJ45)	1	
18	RED CONTROL DO2(RJ45)	1	
17	DC POWER TERMINAL BLOCKS	1	
16	POWER TERMINAL 2 BLOCKS	1	
15	POWER TERMINAL 1 BLOCKS	1	
14	PDU EXTENDER 2 BREAKER	1	
13	PDU EXTENDER 1 BREAKER	1	
12	AC/DC BREAKER	1	
11	CRV2 BREAKER	1	
10	CRV1 BREAKER	1	
9	MBC2 INPUT BREAKER	1	
8	MAIN INPUT BREAKER	1	
7	24VDC OUTPUT BREAKER	1	
6	12VDC OUTPUT BREAKER	1	
5	MBC1 BREAKER	1	
4	BOATLIKE SWITCH FOR BLUE LIGHT	1	
3	SPD	1	
2	SPD BREAKER	1	
1	POWER LIGHT(L1/L2/L3)	3	

FRONT VIEW

REAR VIEW  
(PMU COVER REMOVED)

**NOTES:**  
 PMU20 is used in Power Redundancy and No Power Redundancy PMC  
 Net weight: 41 kg

© 2020 VERTIV GROUP CORPORATION. CONFIDENTIAL AND PROPRIETARY. ALL RIGHTS RESERVED. VERTIV AND THE VERTIV LOGO ARE TRADEMARKS OR REGISTERED TRADEMARKS OF VERTIV GROUP CORPORATION. THIS DOCUMENT (AND THE INFORMATION IT CONTAINS) ARE THE PROPERTY OF VERTIV GROUP CORPORATION. BY ACCEPTING IT INTO YOUR POSSESSION, YOU AGREE THAT YOU WILL KEEP THIS DOCUMENT AND ALL INFORMATION CONTAINED HEREIN IN STRICTEST CONFIDENCE AND WILL NOT COPY, REPRODUCE, TRANSMIT, USE (EXCEPT SOLELY FOR THE BENEFIT OF VERTIV GROUP CORPORATION), SELL, LEND, OR OTHERWISE DISPOSE OF SAME, DIRECTLY OR INDIRECTLY, WITHOUT THE EXPRESS WRITTEN PERMISSION OF VERTIV GROUP CORPORATION, AND THIS DOCUMENT SHALL BE RETURNED TO VERTIV GROUP CORPORATION IMMEDIATELY UPON REQUEST.

SHEET NO. 1 OF 2

CD. NO. -

REF. DWG. -

DRAWN BY: Terry

DESIGNED BY: ITT

APPROVED BY: LE

DATE (LATEST REV.):

REVISION: 505 N. CLEVELAND AVE. OHIO WESTERVILLE, 43082

## Power Management Unit - 20kW (PMU20)

FORM NO. DPN004659 REV - A



## 9. PMU20 Terminal Blocks Size

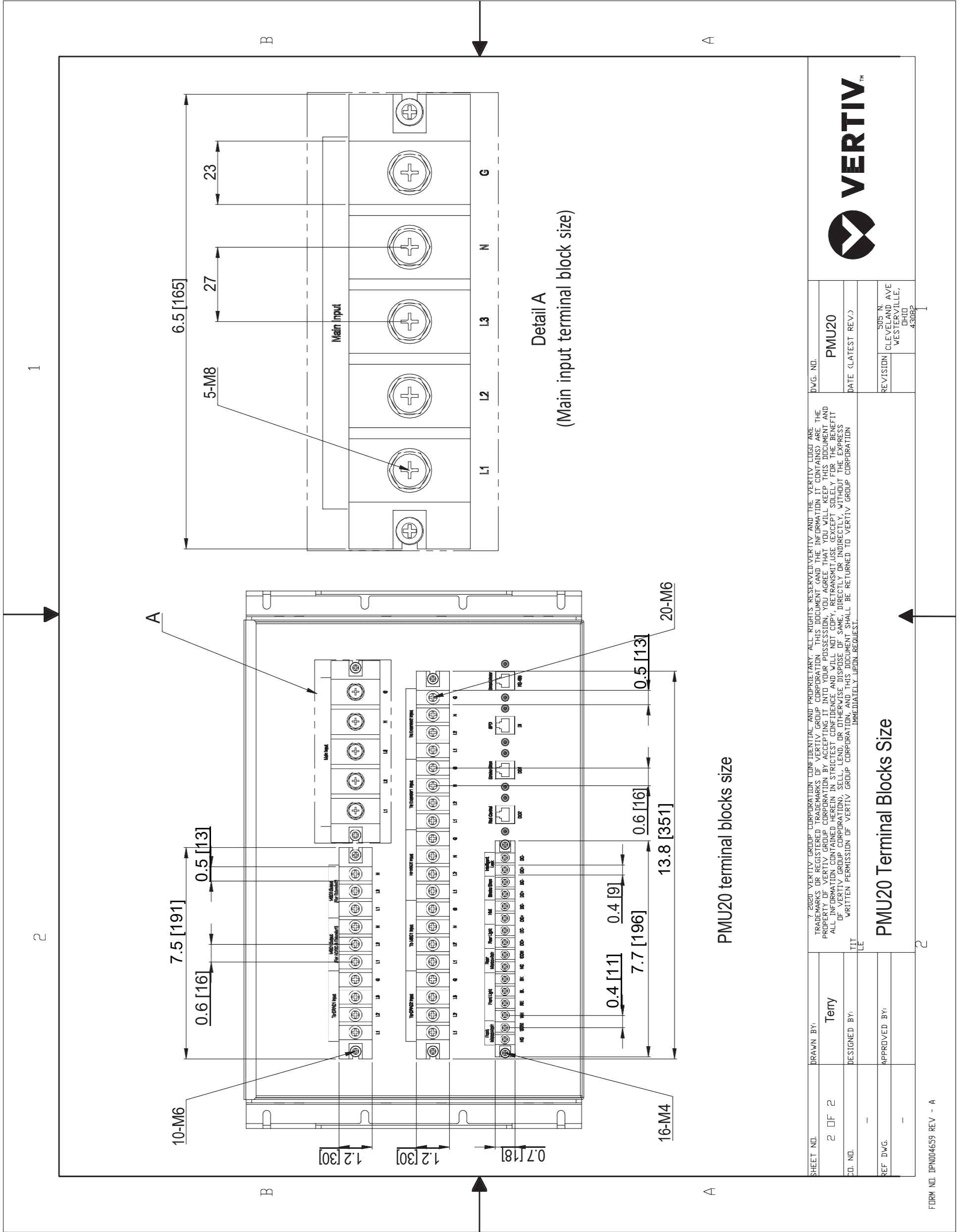

SHEET NO.	2 OF 2	DRAWN BY:	Terry	DWG. NO.	PMU20	
CD. NO.		DESIGNED BY:		DATE (LATEST REV.)		
REF. DWG.		APPROVED BY:		REVISION		SUS. N. CLEVELAND AVE WESTERVILLE, OHIO 43082

© 2020 VERTIV GROUP CORPORATION. CONFIDENTIAL AND PROPRIETARY. ALL RIGHTS RESERVED. VERTIV AND THE VERTIV LOGO ARE TRADEMARKS OR REGISTERED TRADEMARKS OF VERTIV GROUP CORPORATION. THIS DOCUMENT (AND THE INFORMATION IT CONTAINS) ARE THE PROPERTY OF VERTIV GROUP CORPORATION BY ACCEPTING IT INTO YOUR POSSESSION, YOU AGREE THAT YOU WILL KEEP THIS DOCUMENT AND ALL INFORMATION CONTAINED HEREIN IN STRICTEST CONFIDENCE AND WILL NOT COPY, REPRODUCE, TRANSMIT, USE (EXCEPT SOLELY FOR THE BENEFIT OF VERTIV GROUP CORPORATION), SELL, LEND, OR OTHERWISE DISPOSE OF SAME, DIRECTLY OR INDIRECTLY, WITHOUT THE EXPRESS WRITTEN PERMISSION OF VERTIV GROUP CORPORATION, AND THIS DOCUMENT SHALL BE RETURNED TO VERTIV GROUP CORPORATION IMMEDIATELY UPON REQUEST.

**PMU20 Terminal Blocks Size**

# 10. Vertiv MSR2 - CT600 Cable Tray 600mm

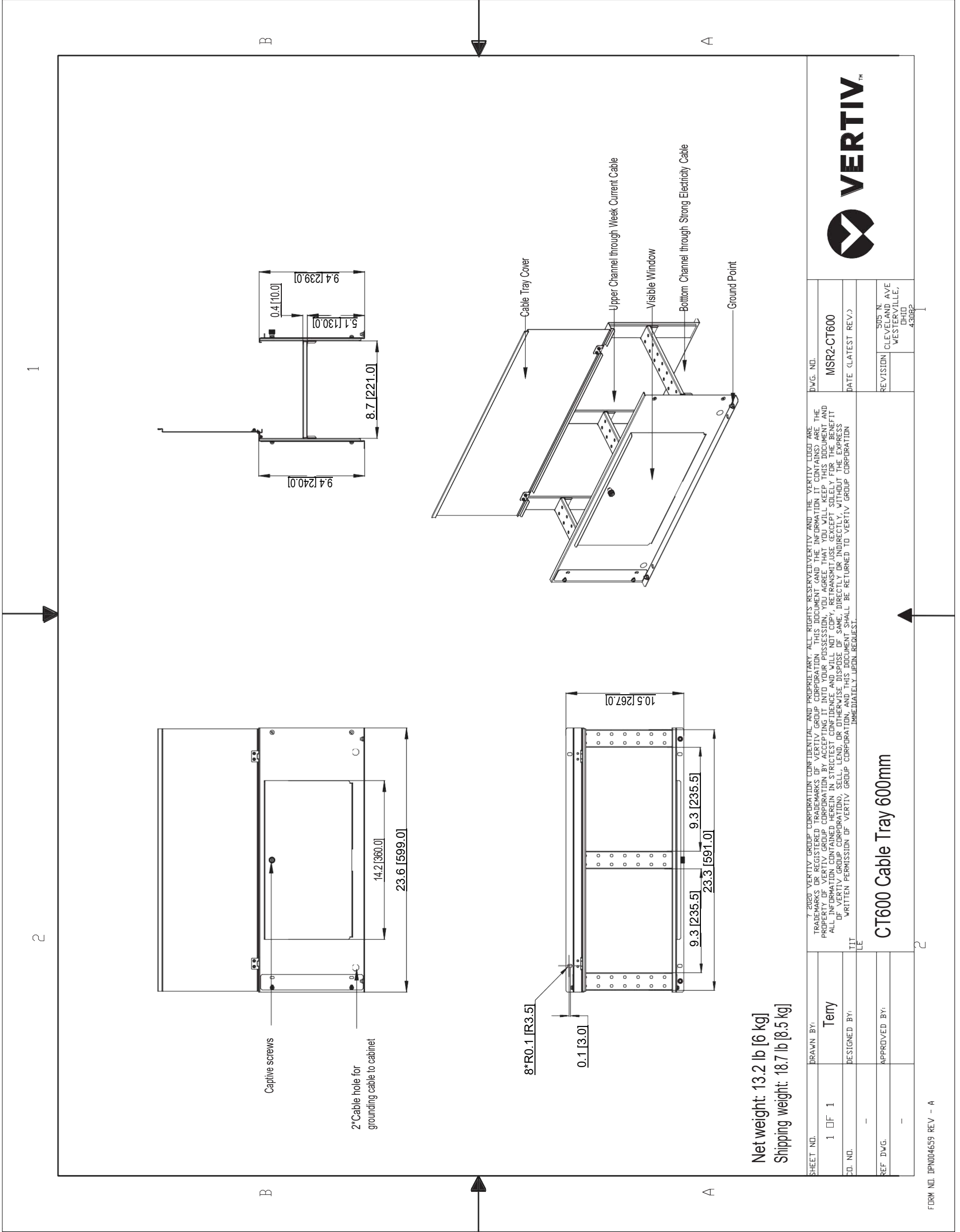

# 11. Scope of Work

## SmartRow2 Assembly

### SERVICE SUMMARY

Feature	Detail
On-Site Service	Site trip(s) within the 48 contiguous states. Visit(s) to be scheduled by the customer between 7 am-5 pm, Monday-Friday (excluding weekends & national holidays).
Customer Support	Includes access to the Customer Resolution Center (1-800-543-2378) and the Vertiv Customer Services Network Online Internet portal for extent of product warranty.
Consolidation	The SmartRow2 includes numerous shippable units (typically pallets or boxes) that originate from multiple factories and suppliers. Vertiv consolidates these items into a single customer shipment and reduces the likelihood of shippable units being lost at the customer site. This benefits the customer by relieving the burden of keeping track of multiple partial shipments.
Inside Delivery	Vertiv Service will move the shippable units from the delivery truck to the Staging Area. Vertiv Services will unpackage the shippable units and remove/dispose of the packaging material so that it is ready for assembly. Vertiv will verify that all material on the sales order has been received.
Project Management	Included with Consolidation and Inside Delivery. Vertiv will assign a project manager for the project. The Project Manager will supervise the Consolidation and Inside Delivery Process and communicate hardware shipment schedules with the customer.
Assembly	SmartRow2 is assembled onsite by Vertiv factory-trained and authorized technicians equipped with Vertiv Proprietary tools and software. Vertiv CEs and Vertiv Partners are the only approved OEM service providers for Vertiv products. These technicians are supervised by a Site Manager who also gathers site-specific requirements like safety and work procedures
Factory Startup	Warranty inspection and startup validates the warranty and initializes the warranty coverage period

### SERVICE PERFORMED

#### Consolidated Shipment

Shippable units may be available at time of order or built-to-order with a lead time. Vertiv safely stores these items in-warehouse until the customer is ready to receive the SmartRow2 in a single shipment. Other limits may apply; see Assumption and Clarifications as applicable for more details.

#### Inside Delivery

Vertiv Services will deliver the shippable units from the delivery truck to the Staging Area. Vertiv Services will unpackage the shippable units and remove/dispose of the packaging material so that it is ready for assembly. Vertiv will verify that all material has been received.

Change order option:

- There must be an appropriate loading dock with continuous, level floor from the dock to the staging area. If the shippable units must be moved up/down stairs, the customer must provide a suitable elevator, or charges for special rigging will be incurred. If the customer does not have an appropriate loading dock, nominal charges may/may-not apply for a lift-truck delivery.

#### Project Management

Vertiv will assign a project manager and a site manager for the project.

The Project Manager will supervise the Consolidation and Inside Delivery Process and communicate schedules with the customer. The Site Manager will supervise the assembly, startup, warranty inspection and turn over the SmartRow2 to the customer.

#### Site-Specific Requirements

All personnel will be available for up to two hours per week for Site Access, Safety Training and other site-specific requirements Change Order Option:

- Vertiv can quote a price for additional man-hours if 2 hours per week is insufficient.

#### Assembly

There shall be continuous, level floor between the Staging Area and the Installation Location so that heavy items can be moved via casters/pallet jacks.

Change Order Option:

- If there is not continuous level floor, the customer must provide or pay for any necessary lift/rigging equipment.

## Project Management

### Vertiv PMC, including RDU501 SmartRow2 Controller/Display

Vertiv will position, level, and bay together the PMC as described in the submittal documents.

The customer is responsible for providing primary electrical power to the PMC.

Vertiv will program and configure the SmartRow2 RDU501 controller/display. This includes setting IP addresses so that the customer can monitor the system status remotely

Change Order Option:

- Vertiv will quote IP addressing of equipment on the customer network, but this would be done by other personnel and scheduled separately. This is outside the scope of SmartRow2 assembly.

### Vertiv IT Rack(s)

Vertiv will position, level, and bay together the Vertiv IT Racks as described in the submittal documents. Vertiv will not populate racks with customer IT gear, including blanking panels, servers, shelves, etc.

The customer must define addressing conventions (1,2,3,4, right-to-left or left-to-right) prior to start of work.

### Cable Trays

Vertiv will install the SmartRow2 cable trays that are included with the SmartRow2 solution as described in the submittal documents

### Liebert®CRV's, Temperature Sensors, Modbus cables, and associated Plenums

Vertiv will position and level the Liebert® CRV and attach the associated plenums to provide cooling to the SmartRow2.

Vertiv will connect the necessary temperature sensors.

The customer is responsible for piping and primary power to the CRV along with connecting CANBus cable between the CRV and heat rejection. All specific requirements (such as piping traps and proper electrical rounding) for correct product installation are detailed in the product installation manual.

After the SmartRow2 is assembled and the Liebert® CRV is piped and powered by the customer in accordance with the product installation manual, Vertiv will perform a factory warranty inspection along with the rest of the SmartRow2.

### Liebert®MC / CCD Condensers for Liebert®CRV's

The customer is responsible for installing the associated heat rejection. This includes primary power, CANBus communication wire, piping, refrigerant charging, and all other tasks in the Installation Manual. Any/all penetration points in the walls/ceilings/floors for any wiring or piping are also the customer's responsibility.

### Rack PDUs

Vertiv will install and connect all rack PDUs (if applicable) including GXT5 power extensions (if applicable) as described in the submittal documents.

### Liebert®GXT5 Single Phase UPS's

Vertiv will install and connect all Liebert® GXT5 UPS's and connect power within the PMC cabinet and output to the PDUs as described in the submittal documents.

Additionally, Vertiv will install ancillary equipment such as Maintenance bypass and PD2-103 cabling and connectors if not already preinstalled.

After the SmartRow2 is assembled and Primary Power to the SmartRow2 is provided by the customer, Vertiv will perform factory startup of all GXT5 equipment along with the rest of the SmartRow2.

### Switch

Vertiv will install and connect the switch within the PMC cabinet. as described in the submittal documents

### Firmware Updates

Vertiv will update firmware of any/all units to the current revision level. Shippable units are sourced globally and firmware evolves as products may be in stock with prior revisions.

### Wiring

Vertiv will run all necessary wiring for power and communication between cabinets as part of assembly. This includes setting IP/DIP switch settings for proper communication between the device and the PMC.

### Accessories

The SmartRow2 is available with lights, door locks/sensors, temperature sensors that Vertiv will connect and install. Services associated with cameras are sold separately and out-of-scope for the SmartRow2 Assembly.

### RDU Monitor SmartRow2 mobile application

Services associated with the RDU Monitor SmartRow2 mobile applications are quoted separately and out-of-scope for SmartRow2 assembly.



## ASSUMPTIONS AND CLARIFICATIONS

- Vertiv will cover one month of storage costs as part of the consolidation service. If the original ship date is changed due to non-Vertiv delays, the customer is liable for any costs associated with the extended storage time.
- Vertiv start-up validates product warranty.
- Defects or damage resulting from installation not performed by Vertiv are not covered.
- Parts and Labor coverage is in accordance with Product Warranty. If a modified warranty is purchased, terms default to that specific package.
- Any customer site visit is limited to eight (8) hours per visit. Any time beyond forty (40) hours/wk or eight (8) hrs/day or additional Startup visits will be billed separately.
- Expenses incurred due to delays that are beyond the control of Vertiv may be billed at cost.
- Startup visit must be scheduled confirmation of proper installation (if Vertiv not involved with installation).
- This pricing excludes any load bank testing. This can also be quoted separately if required.
- Pricing excludes activities associated with 3rd party commissioning
- Pricing excludes any type of circuit breaker NEMA testing. This can also be quoted separately if required.
- Customer/Installing contractor is responsible for providing elevated access as necessary.
- Any additional requests beyond the scope of this document will be billed separately by Vertiv.
- Vertiv will not perform physical changes to the site building (such as drilling holes, etc.)

## CUSTOMER RESPONSIBILITIES

In order to provide timely, accurate and thorough execution of the services described herein, Vertiv requests the following:

- Point of Contact: Provide an authorized point of contact(s), specific for the scope of work, for scheduling and coordination purposes.
- Scheduling: Make dates available for scheduling service. All visits must be requested 10 business days in advance of need by contacting the Vertiv Customer Resolution Center at 1-800-543-2378.
- Site Access: Prior to time of scheduled work, provide site access including any customer required escort, security clearance, safety training and badging for Vertiv service personnel.
- Equipment Access: Convenient access to the equipment covered by the Scope of Work. Prior to scheduled time of work, notify Vertiv service personnel of any special requirements for equipment access including lifts, ladders, etc.
- Shutdown: Service may require shutdown of load to ensure electrical connection integrity.
- Notification: If for any reason the work cannot be performed during scheduled time, notify Vertiv service personnel 24-hours prior to scheduled event.

## TERMS AND CONDITIONS

Subject to all Terms & Conditions as noted in the Vertiv Terms & Conditions or the terms of a Master Agreement between the parties, if any, shall apply.





# SmartRow 2 Scope of Work Checklist

Customer Name: \_\_\_\_\_

Project Name: \_\_\_\_\_

Project Number: \_\_\_\_\_

This document is to serve as a checklist to help identify and budget the various work activities involved with assembling and installing a SmartRow 2. It is the customers responsibility to ensure all tasks are assigned to partners which will result in a successful SmartRow 2 project.

**Contact Vertiv for available local support resources to provide technical guidance as needed. Call 800 543-2378**

The **X** indicates the responsible party for that task. Multiple **X**'s indicate shared responsibility.

This document is provided as a reference document and does not replace any product manuals or supporting documentation. Always read all product documentation before performing any work.

Customer (Name) *includes responsibility for Mechanical, Electrical, and/or General Contractors as needed* : \_\_\_\_\_

Project Management: \_\_\_\_\_

Assembly Team Lead: \_\_\_\_\_

Consolidator: \_\_\_\_\_

Vertiv Warranty Inspection Tech: \_\_\_\_\_

Vertiv Sales Rep (LVO): \_\_\_\_\_

