



NetSure™ Control Unit (NCU) Retrofit Kit

Installation Manual

Kit Specification Number: 60124057

For Use in Spec. No. 582126000 and 581126000 Power System (Main Bay)

Kit Specification Number: 60135833

For Use in Spec. No. 582126000 Power System (Supplemental Bay)

The information contained in this document is subject to change without notice and may not be suitable for all applications. While every precaution has been taken to ensure the accuracy and completeness of this document, Vertiv assumes no responsibility and disclaims all liability for damages resulting from use of this information or for any errors or omissions. Refer to other local practices or building codes as applicable for the correct methods, tools, and materials to be used in performing procedures not specifically described in this document.

The products covered by this instruction manual are manufactured and/or sold by Vertiv. This document is the property of Vertiv and contains confidential and proprietary information owned by Vertiv. Any copying, use or disclosure of it without the written permission of Vertiv is strictly prohibited.

Names of companies and products are trademarks or registered trademarks of the respective companies. Any questions regarding usage of trademark names should be directed to the original manufacturer.

Technical Support Site

If you encounter any installation or operational issues with your product, check the pertinent section of this manual to see if the issue can be resolved by following outlined procedures.

Visit <https://www.vertiv.com/support/> for additional assistance.

TABLE OF CONTENTS

Admonishments Used in this Document	iv
Avertissements utilisés dans ce document	v
Important Safety Instructions	vi
Safety Admonishments Definitions	vi
Safety and Regulatory Statements	vi
Déclarations de Sécurité et de Réglementation	vi
1 Vertiv™ NetSure™ Control Unit (NCU) Retrofit Kit (Main Bay) Installation Instructions	1
1.1 Kit Description	1
1.2 Kit Contents of P/N 60124057	1
1.3 Tools and Material Required	2
1.4 Recording MCA Settings	2
1.5 Verifying Existing Alarm Wiring/Connections	5
1.6 Installation Procedure	6
2 Vertiv™ NetSure™ Control Unit (NCU) Retrofit Kit (Supplemental Bay) Installation Instructions	42
2.1 Kit Description	42
2.2 Kit Contents of P/N 60135833	42
2.3 Tools and Material Required	43
2.4 Recording LVD Switch Settings	43
2.5 Installation Procedure	45
3 Installing the NCU Controller (1M830BNA)	75

Admonishments Used in this Document



DANGER! Warns of a hazard the reader **will** be exposed to that will **likely** result in death or serious injury if not avoided. (ANSI, OSHA)



WARNING! Warns of a potential hazard the reader **may** be exposed to that **could** result in death or serious injury if not avoided. This admonition is not used for situations that pose a risk only to equipment, software, data, or service. (ANSI)



CAUTION! Warns of a potential hazard the reader **may** be exposed to that **could** result in minor or moderate injury if not avoided. (ANSI, OSHA) This admonition is not used for situations that pose a risk only to equipment, data, or service, even if such use appears to be permitted in some of the applicable standards. (OSHA)



ALERT! Alerts the reader to an action that **must be avoided** in order to protect equipment, software, data, or service. (ISO)



ALERT! Alerts the reader to an action that **must be performed** in order to prevent equipment damage, software corruption, data loss, or service interruption. (ISO)



FIRE SAFETY! Informs the reader of fire safety information, reminders, precautions, or policies, or of the locations of fire-fighting and fire-safety equipment. (ISO)



SAFETY! Informs the reader of general safety information, reminders, precautions, or policies not related to a particular source of hazard or to fire safety. (ISO, ANSI, OSHA)

Avertissements utilisés dans ce document



DANGER! Signale au lecteur un risque auquel il *sera* exposé et qui, s'il n'est pas évité, *pourrait* entraîner des blessures graves, voire mortelles. (ANSI, OSHA)



AVERTISSEMENT! Signale au lecteur un risque potentiel auquel il *pourrait être* exposé et qui, s'il n'est pas évité, *pourrait* entraîner des blessures graves, voire mortelles. Cet avertissement n'est pas applicable aux situations dans lesquelles seuls l'équipement, les logiciels, les données ou le service sont à risque. (ANSI)



ATTENTION! Signale au lecteur un risque potentiel auquel il *pourrait être* exposé et qui, s'il n'est pas évité, *pourrait* entraîner des blessures mineures à modérées (ANSI, OSHA). Cet avertissement n'est pas applicable aux situations dans lesquelles seuls l'équipement, les données ou le service sont à risque, même si une telle utilisation semble autorisée dans l'une des normes applicables. (OSHA)



ALERTE! Informe le lecteur d'une action *devant impérativement être évitée* pour protéger l'équipement, les logiciels, les données ou le service. (ISO)



ALERTE! Informe le lecteur d'une action *devant impérativement être effectuée* afin d'empêcher tout endommagement de l'équipement, toute corruption des logiciels, toute perte de données ou toute interruption de service. (ISO)



SÉCURITÉ INCENDIE! Communique au lecteur des informations, des rappels, des consignes ou des politiques en matière de sécurité, ou l'informe de l'emplacement des équipements de sécurité incendie ou de lutte contre les Incendies. (ISO)



SÉCURITÉ! Communique au lecteur des informations, des rappels, des consignes ou des politiques en matière de sécurité générale, sans aucun lien avec une source de danger particulière ou avec la sécurité incendie. (ISO, ANSI, OSHA)

Important Safety Instructions

Safety Admonishments Definitions

Definitions of the safety admonishments used in this document are listed under “Admonishments Used in this Document” on page iv.

Safety and Regulatory Statements

Refer to Section 4154 (provided with your customer documentation) for Safety and Regulatory Statements.

Déclarations de Sécurité et de Réglementation

Reportez-vous à la Section 4154 (fourni avec les documents de votre client) pour les déclarations de sécurité et de réglementation.

1 Vertiv™ NetSure™ Control Unit (NCU) Retrofit Kit (Main Bay) Installation Instructions

1.1 Kit Description

These instructions provide a step-by-step procedure to field install this kit into a Vertiv™ NetSure™ 701 Series DC Power System and Vertiv™ NetSure™ 700 Series DC Power System (Spec. No. 582126000 and 581126000, Main Bay). Installation of this kit in other equipment should not be attempted.

This kit, along with the NCU controller (ordered separately), replaces the MCA controller and its associated components.

1.2 Kit Contents of P/N 60124057

Table 1.1 lists the items furnished as a part of this kit. Before installing the kit, check the items furnished against those listed to ensure that there are no shortages.

Table 1.1 Kit Contents

P/N	Description	Qty.
430021G1	LVD Driver Board	1
430001G1	INTERFACE Board	1
10060325	+24V/-48V Main Bay Harness, Kit (this kit includes items with ***)	1
*** 10060320	Jumper, Interface, Last Rectifier Shelf	1
*** 10060319	Jumper, Interface, Battery Shunt	1
*** 10060318	Jumper, Interface, Shunt	1
*** 10063152	Jumper, MBD, NCU Retrofit	1
*** 10063153	Jumper, CAN Input, w/connectors (Option-1)	1
*** 10063154	Jumper, CAN Input, Splicing (Option-2)	1
*** 548398	Jumper, Terminator Plug, Shorting	2
*** 60150617	Label, Name Plate, 701 Main Bay	2
*** 60154247	Label, Name Plate, 700 Main Bay	2
*** 225120700	Screw, Phil PH 6-32 x 1/2in (additional hardware)	2
*** 233394000	Screw, Phil PH 6-32 x 1/4in (additional hardware)	4
*** 73-78-440	Shrink sleeving, Size 3/4in.	12 inches
*** 237650200	Cable Tie 3-7/8" Long	6
60121396	NCU Plate Assembly (includes EIB board)	1
60121402	IB2 Board Mounting Assembly	1
60121198	IB4 Board Assembly	1
430011G1	SHUNT I/O Board	1
60121478	Front Plate	1
60128403	Lexan Panel	1

Note: Mounting hardware for the kit components are provided with the individual component packaging.

Additional Items (not included in kit, ordered separately)		
P/N	Description	Qty.
1M830BNA	NCU Controller (Order with desired configuration)	1
60121401	SMDU+ Assembly, Internal (optional) (this kit includes items with ***)	1
***SMDU2	SMDU+	1
***541277	Assembly, Shunt Interface board	1
***60131605	Insulation Piece, SMDU+	1
***233394000	Screw, Phil PH 6-32 x 1/4in (additional hardware)	6

1.3 Tools and Material Required

Table 1.2 lists the items required to install this kit.

Table 1.2 Tools and Material Required

Description
Flat head screwdriver
1/2-inch Nut Driver
#2 Phillips Screwdriver
3mm Slotted Screwdriver
Stripper
Ty wrap Cutter

1.4 Recording MCA Settings



NOTE! Before installing this kit, manually record the settings in Table 1.3.

Manually record all existing MCA settings or record the required settings for your site from your company's DC Plant Set Points specifications (standards) in Table 1.3, as applicable. The values can be found by scrolling through the various MCA menus. Refer to this table when making setting adjustments via the NCU later in the procedure. A configuration drawing is provided with the NCU controller to be used with the retrofit. Columns are provided with that drawing to record any adjustments made along with initials and date.

Table 1.3 MCA Settings

MCA Setting Name	MCA Setting	NCU Web Page Section	NCU Setting Name
Float Voltage		Battery Tab	Float Charge Voltage
Test/Equalize Voltage		Battery Tab	Equalize Charge Voltage
High Voltage Shutdown		Rectifiers Tab	HVSD Limit
Current Limit		Rectifiers Tab	Current Limit
Battery Current Limit		Battery Tab	Battery Current Limit
System HV1		System Tab	Over Voltage 1
System HV2		System Tab	Over Voltage 2
System BOD		System Tab	Under Voltage 1
System 50% BOD		System Tab	Under Voltage 2
System Current Alarm		System Tab	System Current Alarm

MCA Setting Name	MCA Setting	NCU Web Page Section	NCU Setting Name
Subsystem HV		DC–DC Converter Tab	Over Voltage
Subsystem LV		DC–DC Converter Tab	Under Voltage
Subsystem Current Alarm		DC–DC Converter Tab	Over Current
Batt Charge Current Alarm		Battery Tab	Over Current Limit
High Temp 1		Temp Probes Tab	<Device> Temp# High 1
High Temp 2		Temp Probes Tab	<Device> Temp# High 1
High Temp 3		Temp Probes Tab	<Device> Temp# High 1
High Temp 4		Temp Probes Tab	<Device> Temp# High 1
High Temp 5		Temp Probes Tab	<Device> Temp# High 1
High Temp 6		Temp Probes Tab	<Device> Temp# High 1
High Temp 7		Temp Probes Tab	<Device> Temp# High 1
High Temp 8		Temp Probes Tab	<Device> Temp# High 1
Low Temp 1		Temp Probes Tab	<Device> Temp# Low
Low Temp 2		Temp Probes Tab	<Device> Temp# Low
Low Temp 3		Temp Probes Tab	<Device> Temp# Low
Low Temp 4		Temp Probes Tab	<Device> Temp# Low
Low Temp 5		Temp Probes Tab	<Device> Temp# Low
Low Temp 6		Temp Probes Tab	<Device> Temp# Low
Low Temp 7		Temp Probes Tab	<Device> Temp# Low
Low Temp 8		Temp Probes Tab	<Device> Temp# Low
LVD 1A		LVD Tab	LVD1 Disconnect Voltage
LVD 1B		LVD Tab	LVD1 Disconnect Voltage
LVD 2A		LVD Tab	LVD2 Disconnect Voltage
LVD 2B		LVD Tab	LVD2 Disconnect Voltage
LVD 3A		N/A Only two disconnect voltage levels are available	N/A Only two disconnect voltage levels are available
LVD 3B		N/A Only two disconnect voltage levels are available	N/A Only two disconnect voltage levels are available
LVD Reconnect		LVD Tab	LVD# Reconnect Voltage
Emergency Stop (On/Off)		System Tab	EStop/EShutdown
Low Speed Fan (On/Off)		Rectifiers	Fan Speed Control
Test/EQ Hours		Battery Tab	Maximum Equalize Charge Time (in minutes)
Auto EQ Enable/Disable		Battery Tab	Automatic Equalize
Auto EQ Multiplier		N/A Auto equalize timing is based on battery current	N/A Auto equalize timing is based on battery current
Relay Test Seconds		System Tab	Relay Test Time
Digital Temperature Compensation (Slope)		Battery Tab	Temp Comp Coefficient
Digital Temperature Compensation (MAX W/T)		Battery Tab	Temp Comp Max Voltage
Digital Temperature Compensation (MIN W/T)		Battery Tab	Temp Comp Min Voltage
Temperature Compensation Source		Battery Tab	Temp Comp Sensor

IP Settings:

Manually record existing IP settings (if applicable) in Table 1.4.

Table 1.4 IP Settings

Parameter	Description/Values
IP Address	
Default Gateway	
Subnet Mask	

SNMP Settings:

Manually record existing SNMP settings (if applicable) in Table 1.5.

Table 1.5 SNMP Settings

Parameter	Description/Values
NMS IP	
Public Community	
Private Community	
System Name	
System Location	
System Contact	

LVD Switch Settings:

Manually record the original LVD card switch settings (if applicable) in Table 1.6. Refer to Figure 1.1 for the location of switches S1–S4 on the LVD card and refer to Table 1.7 for the LVD card voltage switch setting.

Table 1.6 Original LVD Card Switch Settings

Switch Number	Distribution Row	Section 1 Setting (ON or OFF)	Section 2 Setting (ON or OFF)
S1	Row 1 (Bottom)		
S2	Row 2		
S3	Row 3		
S4	Row 4		

Figure 1.1 Original LVD Card Switches S1-S4 Location

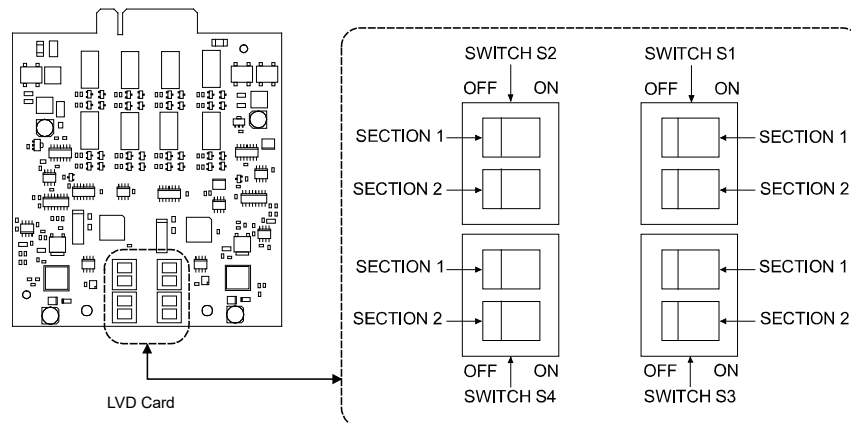

Table 1.7 Original LVD Card Disconnect Voltage Based on Switch Settings

LVD Voltage Setting	Section 1 Setting	Section 2 Setting
Disabled	OFF	OFF
LVD1	OFF	ON
LVD2	ON	OFF
LVD3	ON	ON

1.5 Verifying Existing Alarm Wiring/Connections

Verify, if applicable, that the dry contact alarm connections in the existing system setup are reporting correctly to the network operation center. This is recommended to be performed prior to the retrofit installation to ensure that there are no incorrect pre-existing conditions with these connections that are to be re-purposed.

1.6 Installation Procedure

THESE INSTRUCTIONS SHOULD BE READ THROUGH COMPLETELY BEFORE INSTALLING THE RETROFIT KIT.

The following is a step-by-step procedure to install the retrofit kit and optional items (SMDU+ and NCU controller from the additional items table). The procedure has been written for ease of use and to minimize the possibility of contact with potentially hazardous energy. This procedure should be performed in the sequence given, and each step should be completely read and fully understood before performing that step. Observe all “Important Safety Instructions” starting on page vi and also those presented in the following procedure. As each step of the procedure is completed, the box adjacent to the respective step should be checked. This will minimize the possibility of inadvertently skipping any steps. If the step is not required to be performed for your site, also check the box to indicate that it was read.



DANGER! This kit can be installed with the system operating. Observe the “Important Safety Instructions” starting on page vi and those listed in the power system manual.



CAUTION! When performing any step in procedures that requires removal or installation of hardware, use caution to ensure no hardware is dropped and left inside the unit; otherwise service interruption or equipment damage may occur.



NOTE! When performing any step in this procedure which requires removal of existing hardware, retain all hardware for use in subsequent steps, unless otherwise stated.

Items to be Removed (May Vary Based on Configuration)

Figure 1.2 Items to be Removed (May Vary Based on Configuration)

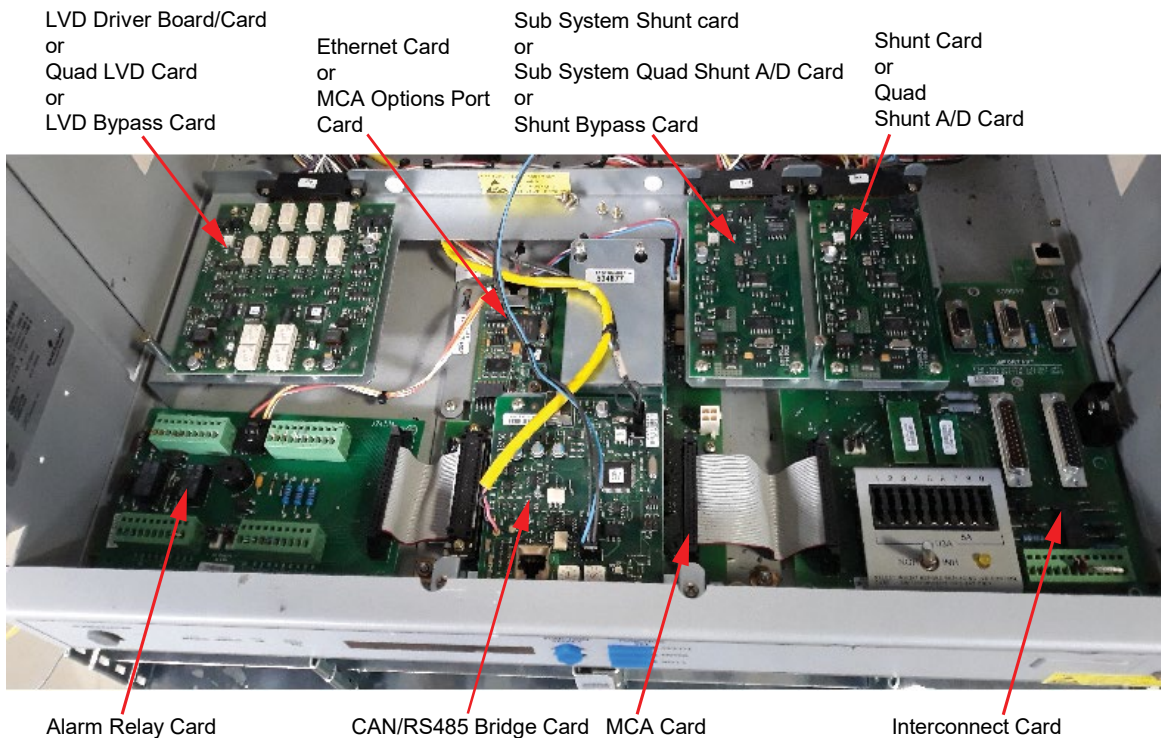

Initial Procedure

- [] 1. Performing this procedure may activate external alarms. Do one of the following. If possible, disable these alarms. If these alarms cannot be easily disabled, notify the appropriate personnel to disregard any future alarms associated with this system while the procedure is being performed.

- [] 2. Open the front door of the bay by turning the latch in the counterclockwise direction using a flat head screwdriver. See Figure 1.3

Figure 1.3 Opening of the Front Door



Removing the MCA (Front Plate Assembly)

- [] 1. Loosen the two (2) #6-32 x 1/2" screws that secure the lexan panel using a #2 Phillips head screwdriver. Slide the lexan panel towards the front side of the system and lift the lexan panel through its key holes. See Figure 1.4.

Figure 1.4 Removing the Lexan Panel

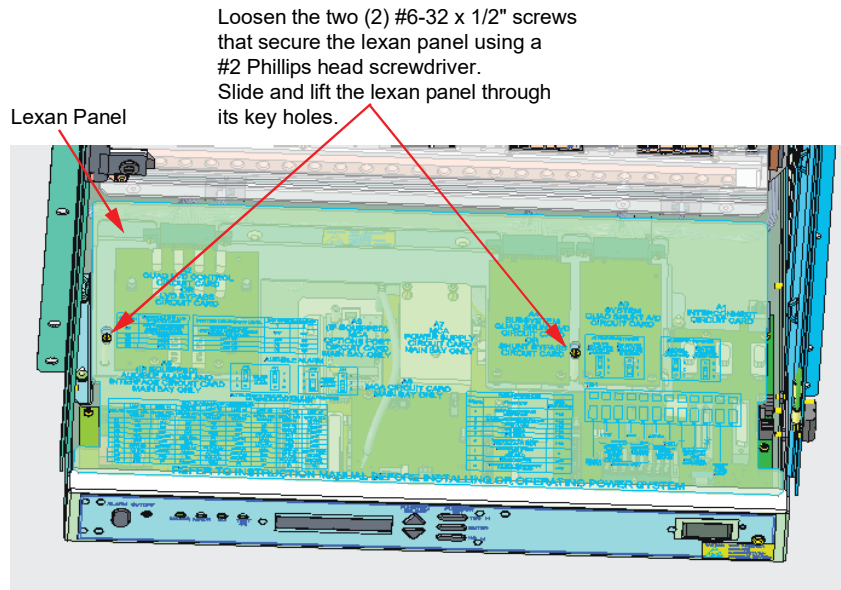

- [] 2. Turn on the inhibit switch on the INTERCONNECT card in main bay and in all supplemental bays. Make sure that the yellow LED is "ON" in each bay. See Figure 1.5.



NOTE! If the inhibit switch for LVDs is not turned on, then they could disconnect and drop the loads.

Figure 1.5 Inhibit Switch Location

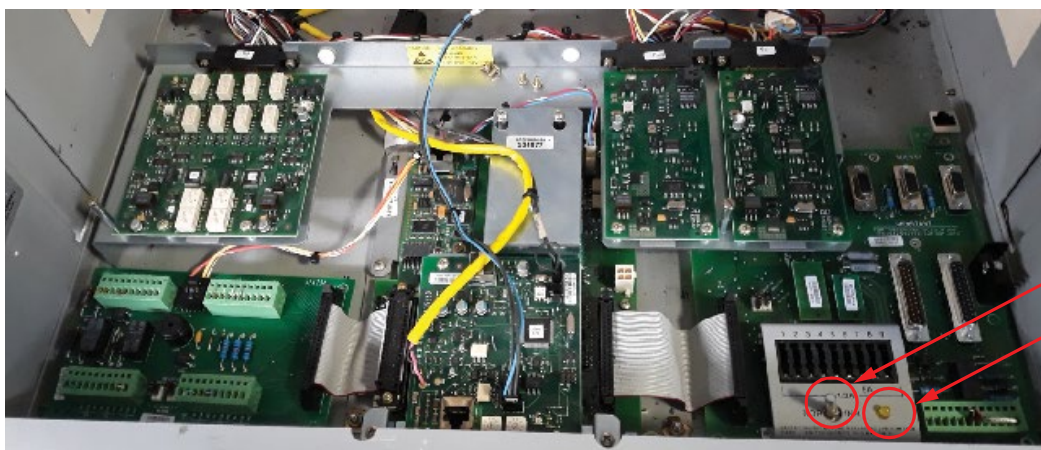

- [] 3. Disconnect the cables. See Figure 1.6.

NOTE! Some cables/connections may not be present depending on the original system configuration.

Figure 1.6 Disconnecting the Cables (cont'd on next page)

2. Disconnect the CAT5 cable (if present).

1. Disconnect the ribbon cable plug on the alarm relay card (J8 connector) (if present).

Alarm Relay Card

Note: This cable is present only if converters are included in the system.

3. Remove jumper wire connected to J3 connector on bridge card (present only if converters are included in the system) and unplug from mini mate-n-lock connector located in the rear of the cabinet.

Figure 1.6 Disconnecting the Cables (cont'd from previous page, cont'd on next page)



4. Remove jumper wire connected to J4 on bridge card (if applicable) and sleeve it with ty wraps as shown below (sleeving (P/N 73-78-440) provided in the kit.) This jumper will not be reused.



5. Remove the wire jumper connected to J15 on MCA assembly. This jumper will be reused.

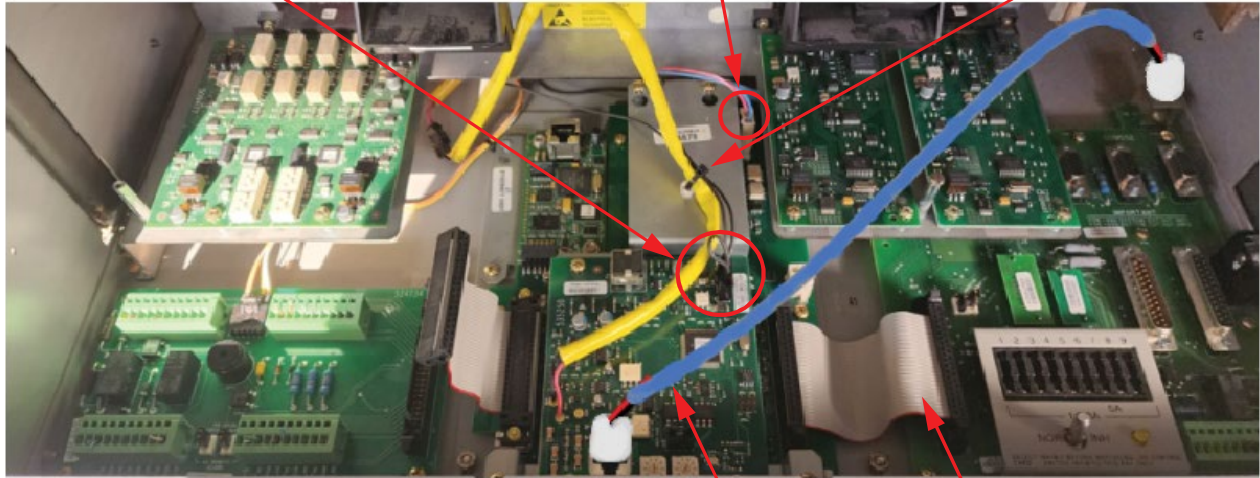

6. Cut the TY-wrap.

8. Remove the CAT5 cable.

7. Remove the ribbon cable connected to J12 on the INTERCONNECT card.



Sleeved Connector

Figure 1.6 Disconnecting the Cables (cont'd from previous page)

9a. If reachable, unplug this connector.

If this connector is unreachable,
perform step 10.

9b. Move this cable towards the front side of the system.

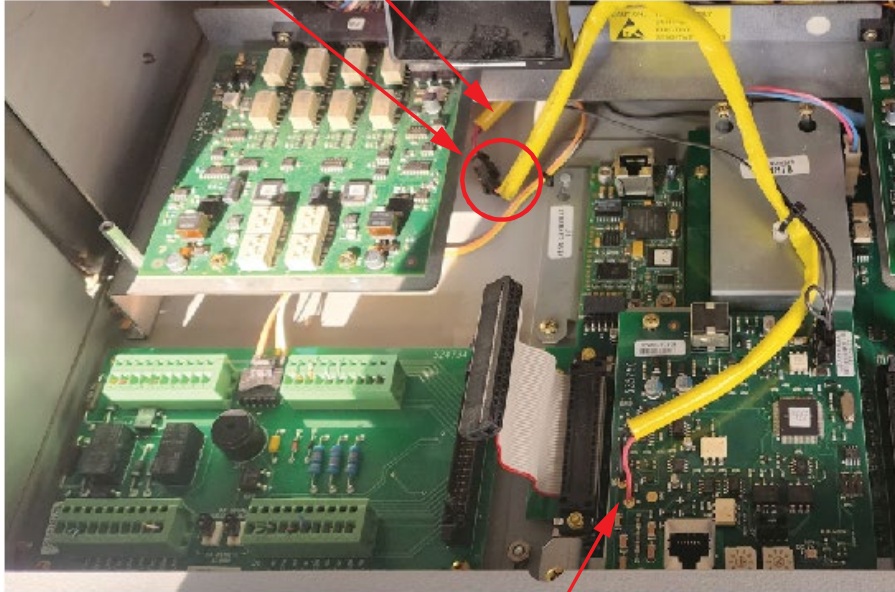

This end of the connector will be plugged into its mating half in the NCU plate assembly which will be installed in the later steps.

10. If the connector is unreachable in step 9a, cut these wires from the circuit board and join them with the jumper P/N 10063154 (red to red and black to black) using the provided splices and heat shrink (if heat gun is available) or using sleeving and ty wraps provided in the kit.

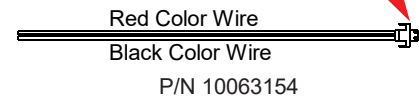

Jumper P/N 10063154 Splicing Procedure

- Cut the wires (red and black) as close to the bridge card as possible.
- Open the jumper bag labelled P/N 10063154 and take out the jumper, splices, and heat shrink (to use if a heat gun is available). Alternatively, have the sleeving and ty wraps provided with the kit accessible.

Using heat shrink:

- Slide one piece of heat shrink on to one of the wires of P/N 10063154.
- Insert the red color wire from P/N 10063154 into one side of splice and the red wire from the yellow jacketed cable into the other side of the splice and crimp both sides of the splice using a crimping tool.
- Slide the heat shrink onto the splice and seal it by using a heat gun.
- Repeat the same for joining the black wires using another splicer and heat shrink piece.

Using the black shrink sleeving (P/N 73-78-440 provided in the kit):

- Cut 1 inch of black shrink sleeving and slide it on to one of the wires of P/N 10063154.
- Insert the red color wire from P/N 10063154 into one side of splice and the red wire from the yellow jacketed cable into the other side of the splice and crimp both sides of the splice using a crimping tool.
- Slide the black shrink sleeving onto the splice and seal it by using ty wraps on both sides of the sleeve (do not use the heat gun).
- Repeat the same for joining the black wires using another splicer and heat shrink piece.

- [] 4. Remove the two (2) #6-32 keps nuts that secure the MCA (front plate assembly) using a #2 Phillips head screwdriver. See Figure 1.7. Pull out the MCA (front plate assembly) from the system.

Figure 1.7 Removing the MCA (Front Plate Assembly)

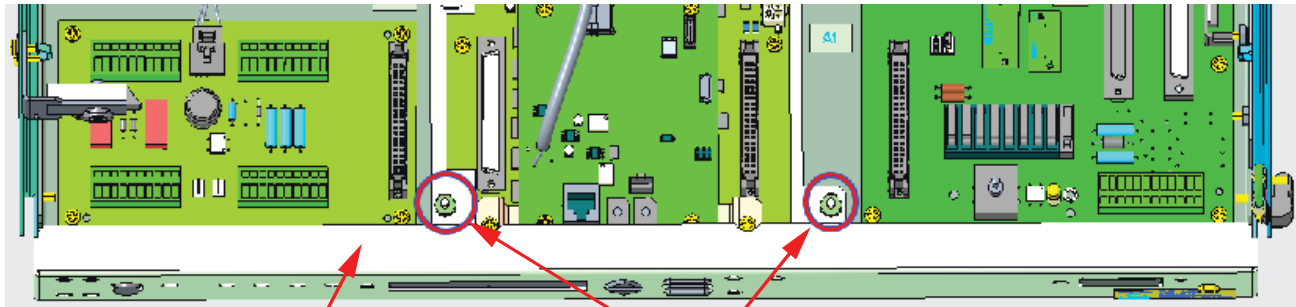

MCA (Front Plate Assembly)

Remove these two (2) #6-32 keps nuts that secure the MCA (front plate assembly) using a #2 Phillips head screwdriver and pull out the MCA (front plate assembly) from the system.

Removing the Alarm Relay Card (if present)

- [] 1. Disconnect the plug from connector J5, sleeve it and push it to the back. See Figure 1.8. This will not be reused.

Figure 1.8 Disconnecting the Cable

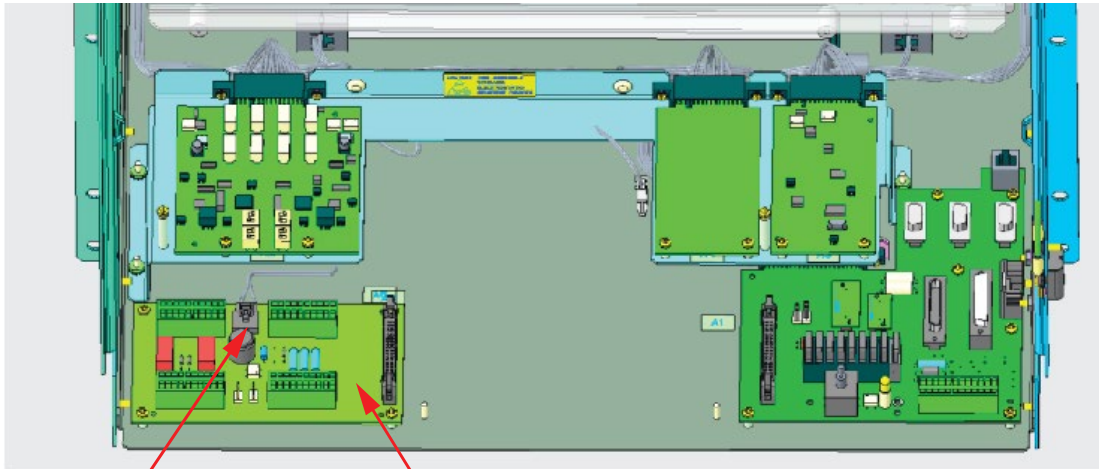

Alarm Relay Card

Disconnect the plug from connector J5, sleeve it and push it to the back.

Removing the LVD Driver Board (if present) or Bypass Board

- [] 1. Make sure that LVD switch settings are recorded in Table 1.6. If not, record the LVD switch settings (If the bypass board is installed in this location, there are no settings to record).
- [] 2. Remove the two (2) #6-32 x 1/4" screws that secure the LVD driver board or bypass board using a #2 Phillips head screwdriver and unplug the LVD driver board or bypass board from the connector. See Figure 1.10.

Figure 1.10 Removing the LVD Driver Board or Bypass Board

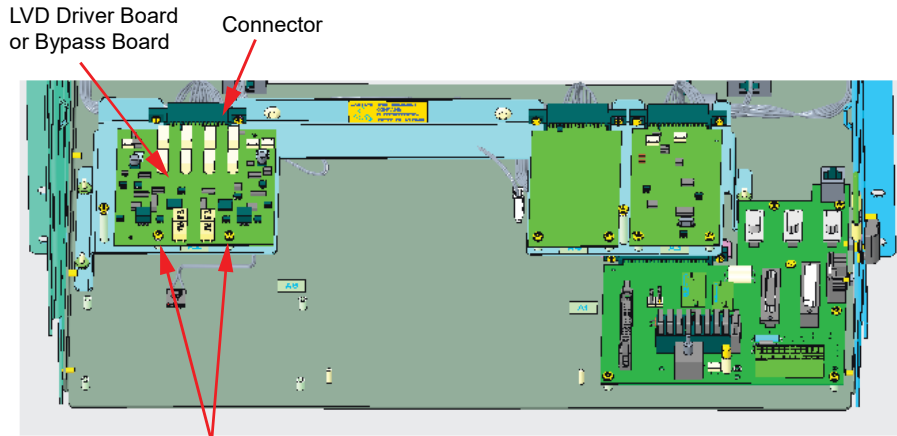

Remove the two (2) #6-32 x 1/4" screws that secure the LVD driver board or bypass board using a #2 Phillips head screwdriver and unplug the LVD driver board or bypass board from the connector.

Removing the Shunt Cards

- [] 1. Remove the four (4) #6-32 x 1/4" screws that secure the shunt card and sub system shunt card using a #2 Phillips head screwdriver and unplug both cards from the connector. See Figure 1.11.

Figure 1.11 Removing the Shunt Cards

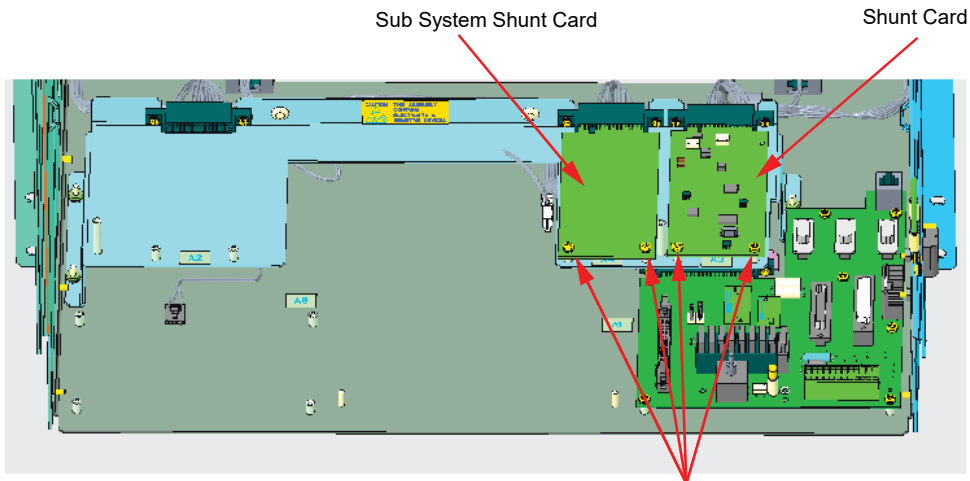

Remove the four (4) #6-32 x 1/4" screws that secure the shunt card and sub system shunt card using a #2 Phillips head screwdriver and unplug both cards from their corresponding connectors.

Installing the New LVD Driver Board (P/N 430021G1)

1. J8 is a system voltage selection connector. Set J8 to the correct voltage setting matching the primary/system voltage (-48V or +24V) of the system that is being retrofitted.

Figure 1.12 Setting the J8 to the Correct Voltage Setting

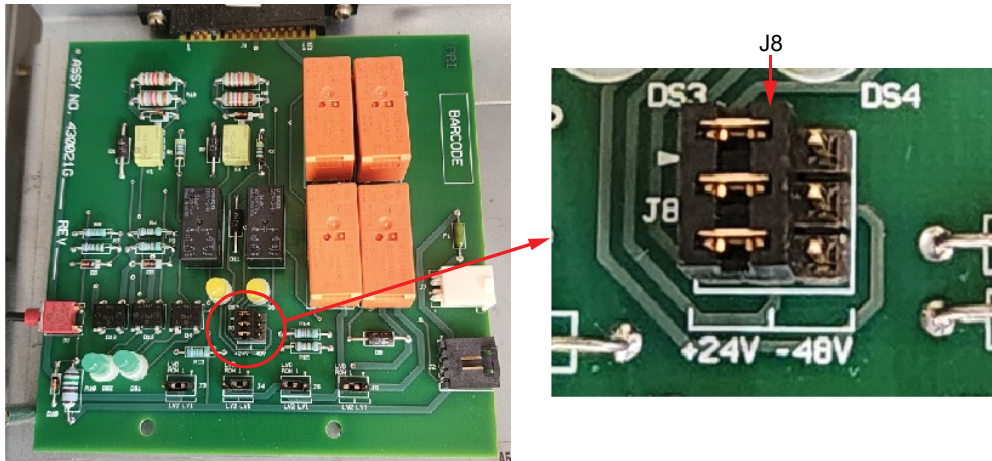

2. The NCU has two (2) Low Voltage Disconnect (LVD) levels to control the operation of the LVDs. For each LVD in the bay, select by pulling out and reseating the jumper to the desired level you want the specific LVD to be controlled by. J3 is for LVD in Row 1 (bottom row), J4 is for LVD in Row 2, J5 is for LVD in Row 3, and J6 is for LVD in Row 4 as shown in Figure 1.13. If no LVD in that specific row, then the respective connector can stay as it is set. Refer to Table 1.7 to set the LVDs to appropriate settings.



WARNING! After the Bay LVD INHIBIT is reset, removing any of the connectors J3-J6 will result in the LVD opening.

Figure 1.13 Setting J3 - J6 (LVD Row 1 through LVD Row 4) to the Correct Voltage Level for Each LVD

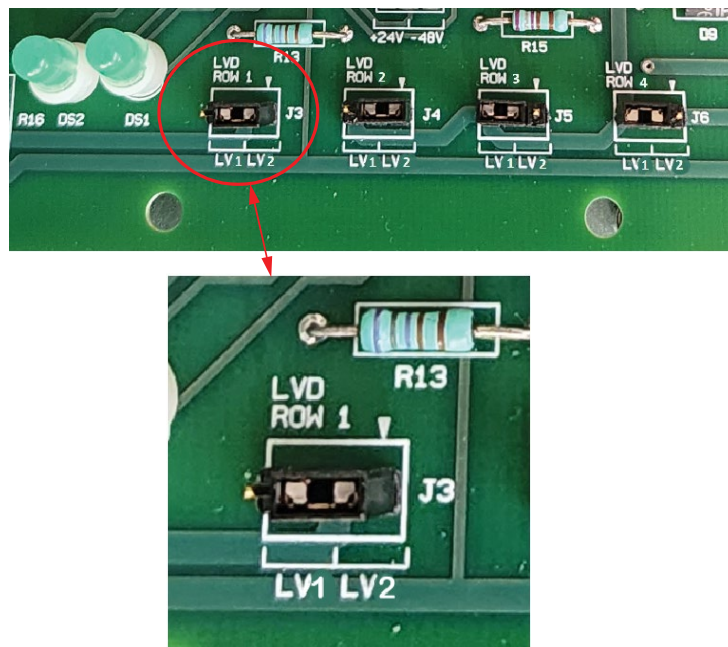

- [] 3. Plug the new LVD driver board to the connector and secure the LVD driver board with the provided two (2) #6-32 x 1/4" screws using a #2 Phillips head screwdriver. See Figure 1.14.

Figure 1.14 Installing the New LVD Driver Board

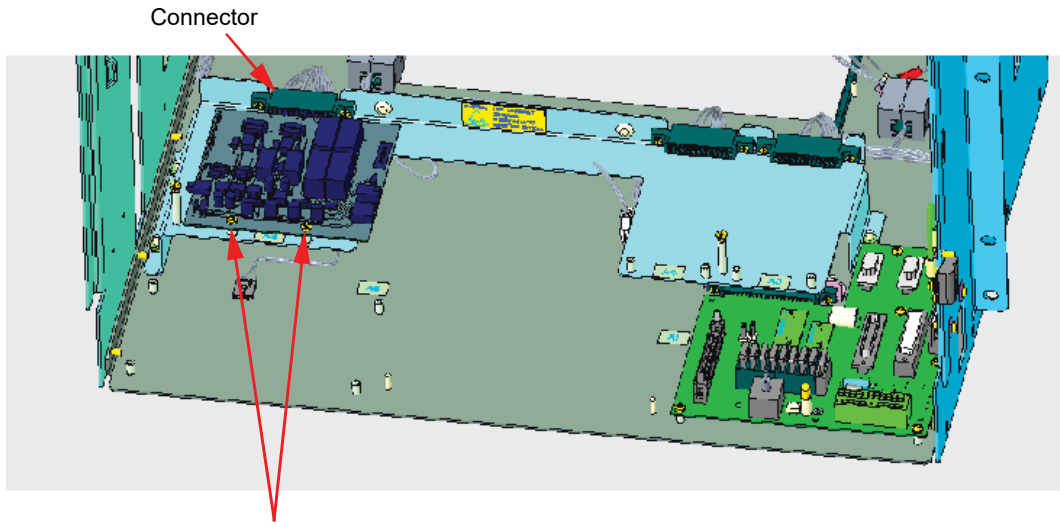

Plug the new LVD driver board to the connector and secure the LVD driver board with the provided two (2) #6-32 x 1/4" screws using a #2 Phillips head screwdriver.

- [] 4. Connect the wire jumper (that was removed from connector J15 of the MCA assembly) to the J7 connector of the LVD driver board. See Figure 1.15.

Figure 1.15 Connecting the Wire Jumper

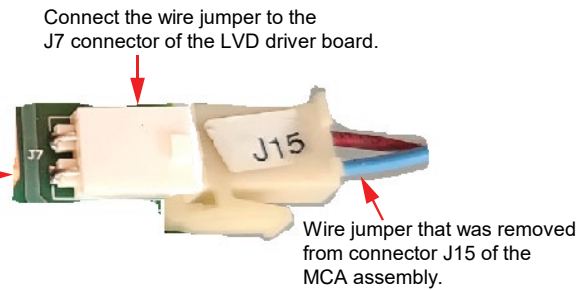
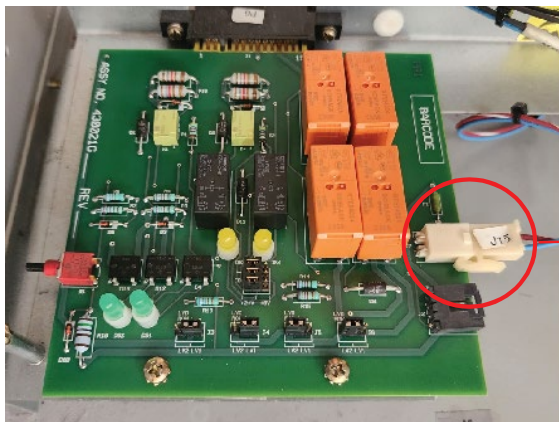

- [] 5. Check if the correct yellow LED comes on for the system voltage (+24V on the left and -48V on the right). If the correct yellow LED does not come on, stop the installation. Troubleshoot the fault for the wrong system type (check J8 is set correctly), power failure (check input voltage is present), or a faulty LVD driver board (replace the board).

Figure 1.16 Yellow LED for the System Voltage

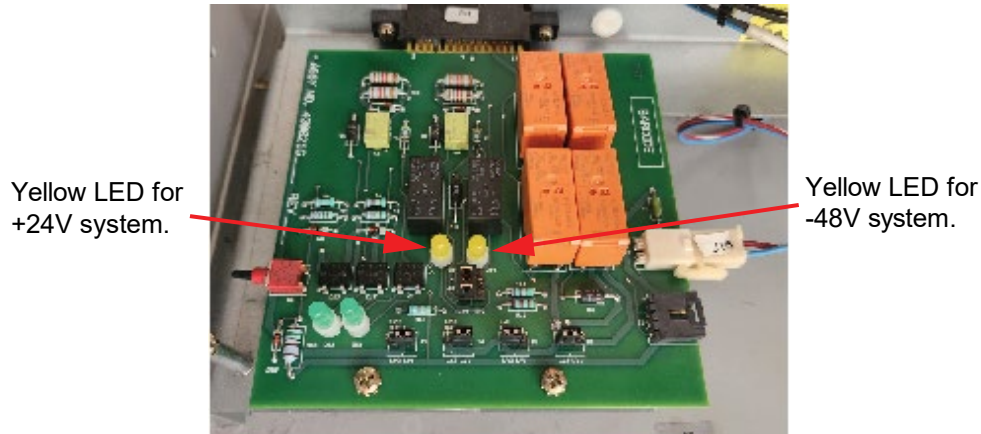

- [] 6. Check if the two (2) green LEDs come on as shown in Figure 1.17. Green LEDs represent power is being applied to the LVDs. If the two (2) green LEDs do not come on, press the Push button on the LVD driver board as shown in Figure 1.17. Ensure that the two (2) green LEDs come on. Even after pressing the Push button, if both green LEDs do not come on, STOP the installation. The LVD driver board is faulty and needs to be replaced.



NOTE! Two (2) green LEDs and one (1) yellow LED should be ON continuously.

Figure 1.17 Green LEDs on the LVD Driver Board

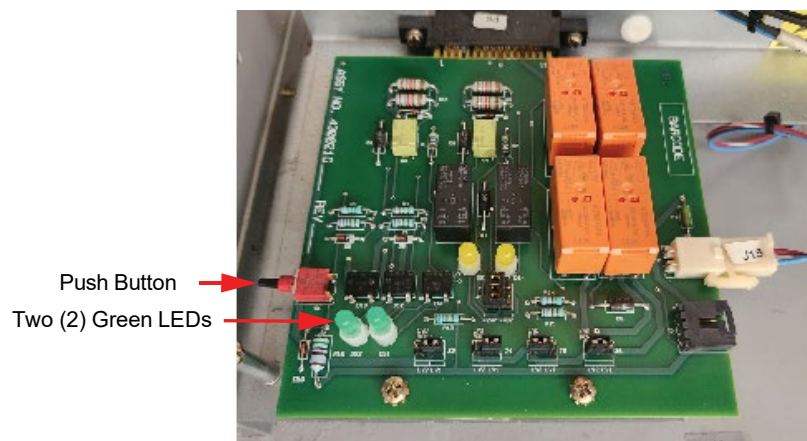

Installing the New INTERFACE Board (P/N 430001G1)

- [] 1. Remove all connections to the original INTERCONNECT card. The cables connected to J1, J2, J8, J9, and J10 (if present) will not be re-used and should be pushed to the back. Wires connected to terminal block TB1 should be labeled as needed. Connections to pins 1 through 5 (remote test/equalize, voltage sense and voltage reading) will not be re-used as these functions are not available once the retrofit kit is installed. Connections to pins 6 and 7 (internally fused voltage source) which would be feeding an LMS1000 system, will not be used after the retrofit kit installation is completed. Connections to pins 8, 9 and 10 (ESTOP) will be connected to the IB2 card, if needed. Connection to pin 11 (remote fuse/CB alarm input) will be reconnected to the new INTERFACE board, if needed. Remove these wires from the terminal block either with a 3 mm slotted screwdriver or cutting them close to the terminal block.

- [] 2. Remove the old INTERCONNECT card by removing the six (6) #6-32 x 1/4" screws using a #2 Phillips head screwdriver. See Figure 1.18.

Figure 1.18 Removing the INTERCONNECT Card

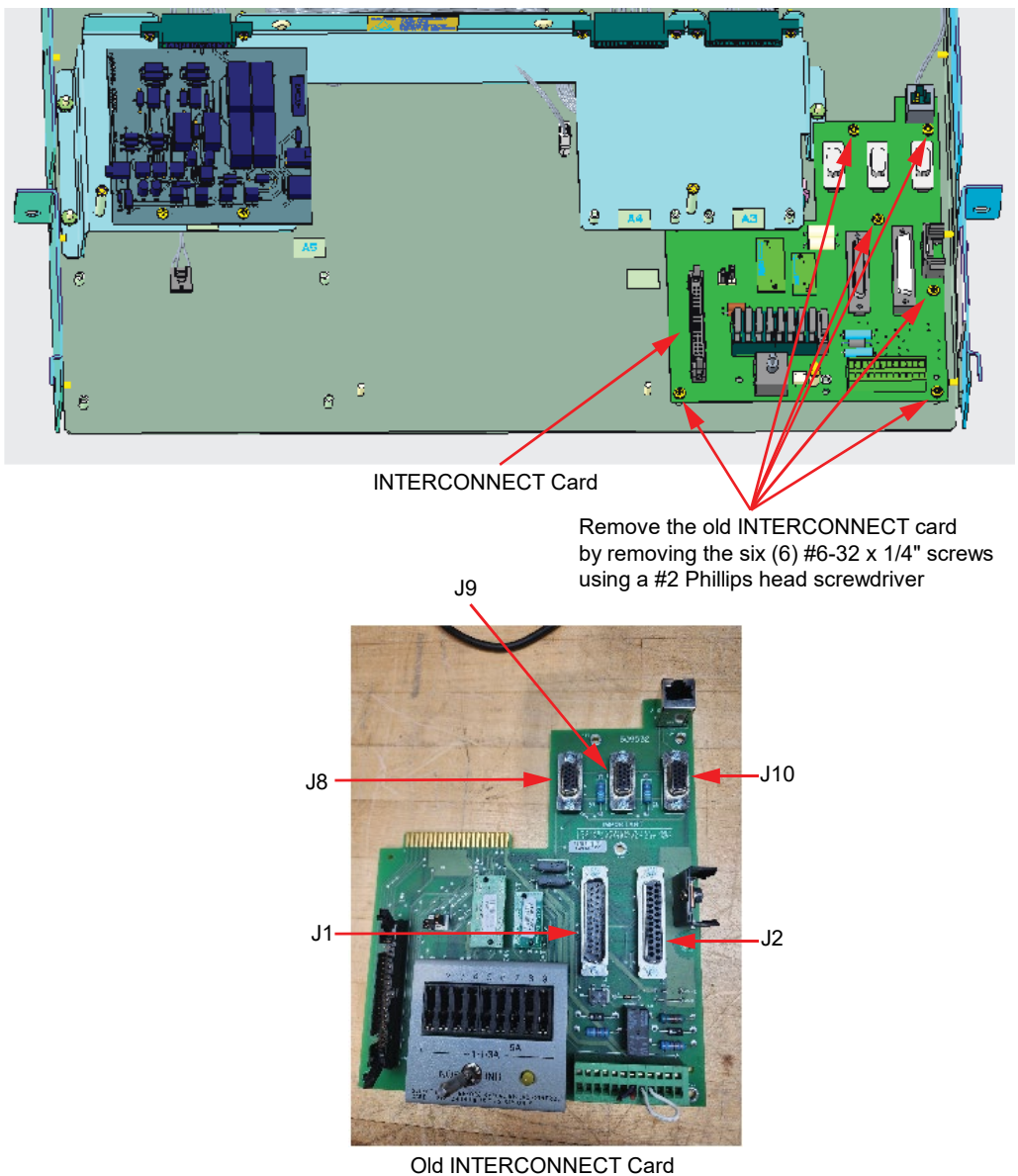

- [] 3. Before installing the board, remove the three (3) fuses from the new INTERFACE board as shown in Figure 1.19. Save these three (3) fuses for later reuse. These fuses are for auxiliary power. Refer to the “INTERFACE board” section in the Retrofit Kit User Manual (UM60124057) for more information.

Figure 1.19 Removing the Fuses

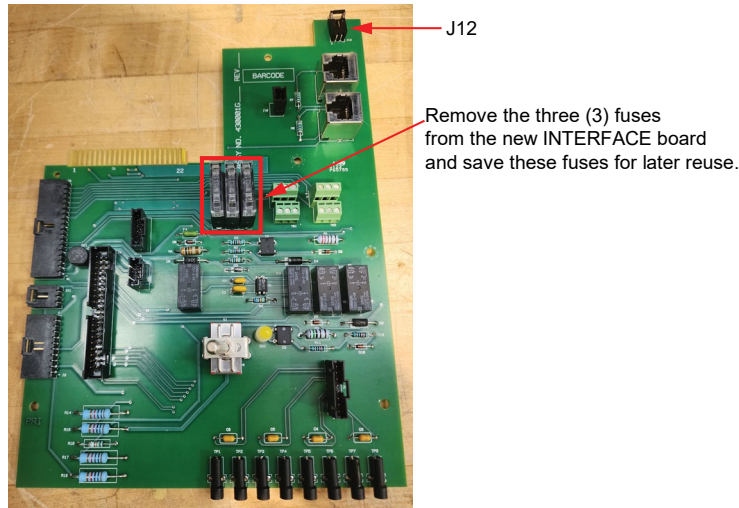

- [] 4. Connect one end of CAN jumper P/N 10060320 (provided in the jumper kit bag, P/N 10060325) to the J12 on the new INTERFACE board. See Figure 1.20. The connector on the other end will be secured to the last rectifier shelf connector in the later steps.

Figure 1.20 Connecting the CAN Jumper P/N 10060320

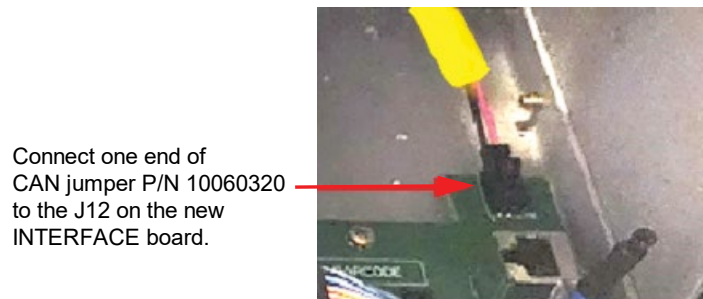

- [] 5. Plug in the new INTERFACE board in the location shown in Figure 1.21 aligning the six (6) mounting screw locations.



NOTE! The INTERFACE board should be plugged into a connector that is located under the sheet metal.

Figure 1.21 INTERFACE Board Plug In

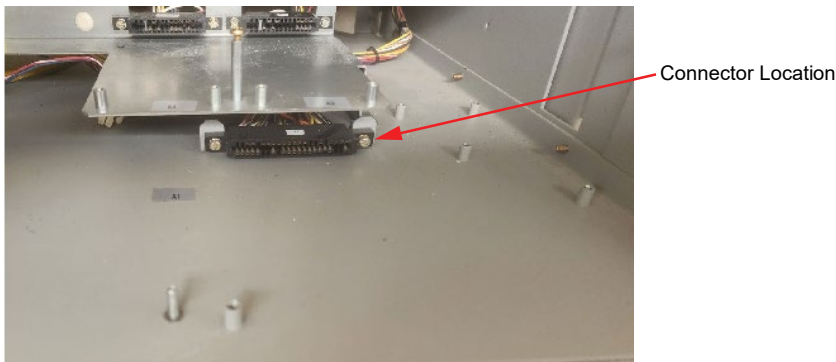
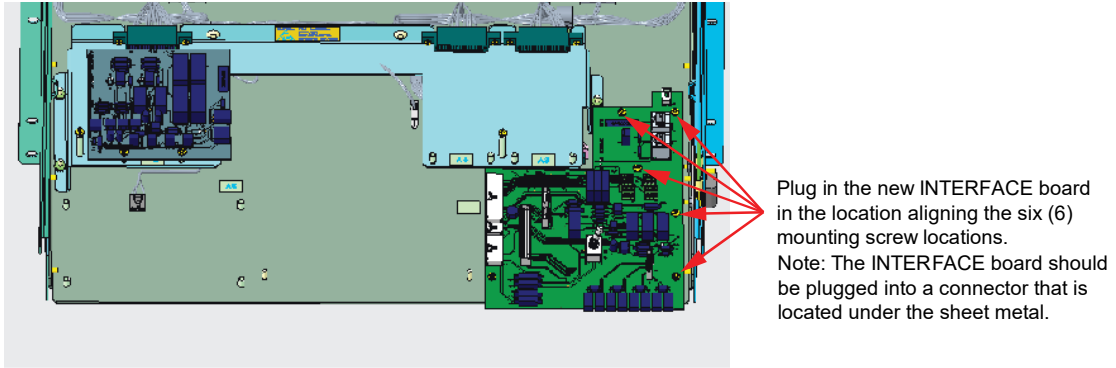

- [] 6. Secure the new INTERFACE board with the provided six (6) #6-32 x 1/4" screws using a #2 Phillips head screwdriver. See Figure 1.22.

Figure 1.22 Installing the INTERFACE Board

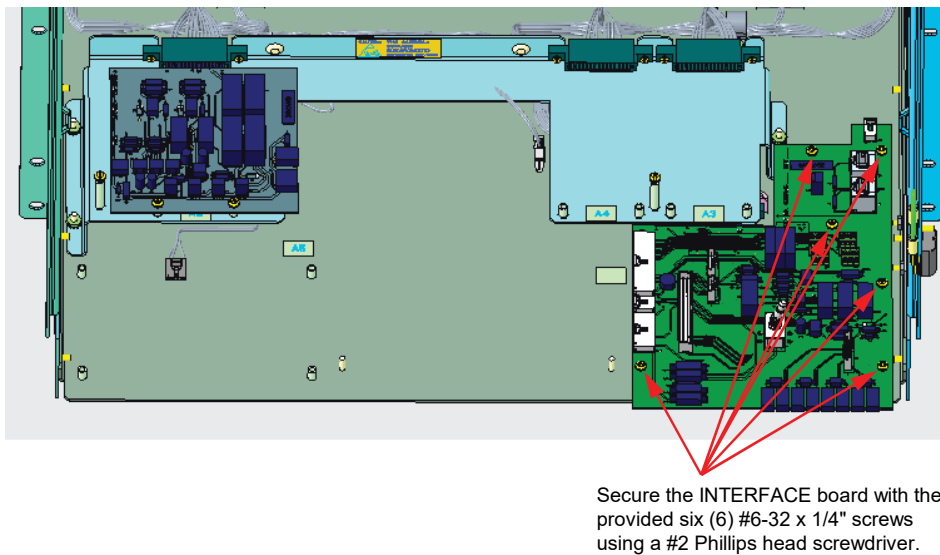

- [] 7. Turn ON the inhibit switch. Make sure that the Yellow LED on the INTERFACE board comes on.

Figure 1.23 Inhibit Switch Location

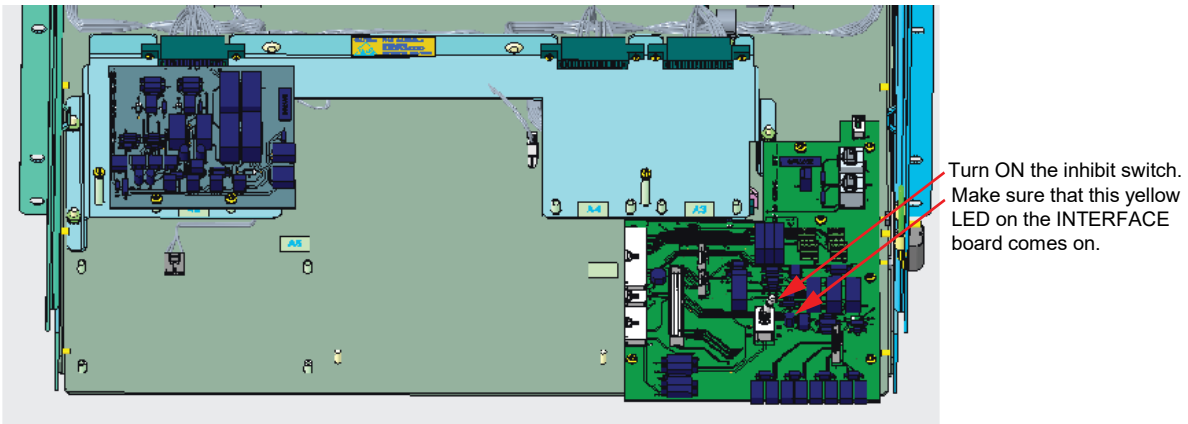

- [] 8. Route the other end of CAN jumper P/N 10060320 through the back of the system to the last rectifier shelf. Remove the terminator (if applicable) from the cable on the rectifier shelf and connect the connector to CAN jumper P/N 10060320. See Figure 1.24. Slack cable has to be ty wrapped and tucked away from sharp edges.

Figure 1.24 Routing of the CAN Jumper P/N 10060320 and Connection (cont'd on next page)

Note: For some systems, the CAN connector in the last rectifier shelf is accessible from the bottom of the shelf.

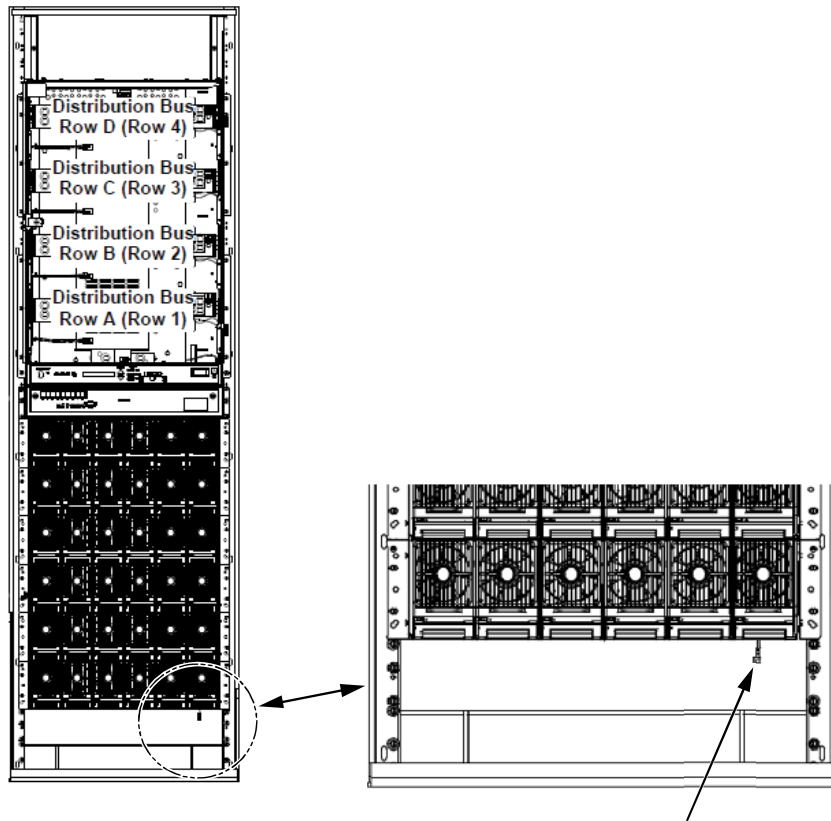

Route the other end of CAN jumper P/N 10060320 through the back of the system to the last rectifier shelf. Remove the terminator (if applicable) and connect the connector.

Figure 1.24 Routing of the CAN Jumper P/N 10060320 and Connection (cont'd from previous page)

Note: For some systems, the CAN connector has to be accessed from the back of the system.

+24V System:

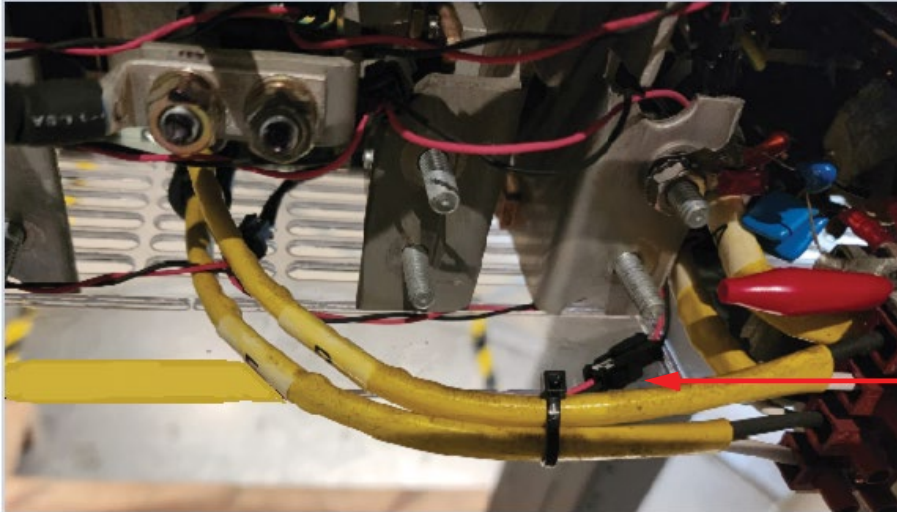

+24V System:

Route the other end of CAN jumper P/N 10060320 through the back of the system to the last rectifier shelf. Remove the terminator (if applicable) and connect the connector.

-48V System:

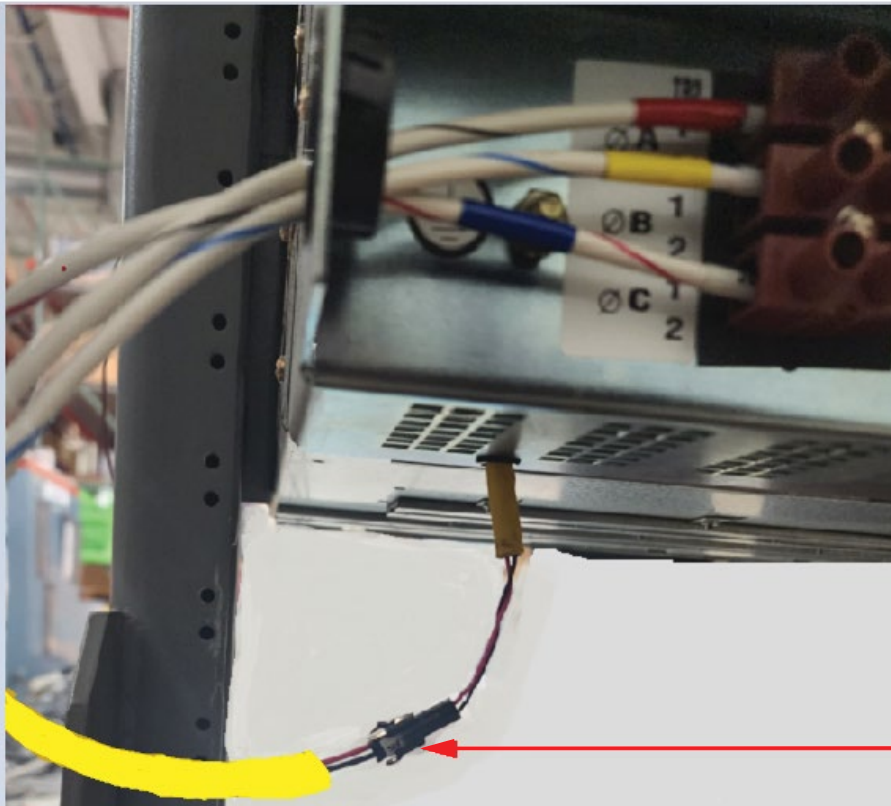

-48V System:

Route the other end of CAN jumper P/N 10060320 through the back of the system to the last rectifier shelf. Remove the terminator (if applicable) and connect the connector.

Installing the NCU Plate Assembly (P/N 60121396)

- [] 1. Set the EIB board DIP switches to the OFF/OFF position. See Figure 1.25.

Figure 1.25 Setting the EIB board (P/N MA455U41) DIP Switches

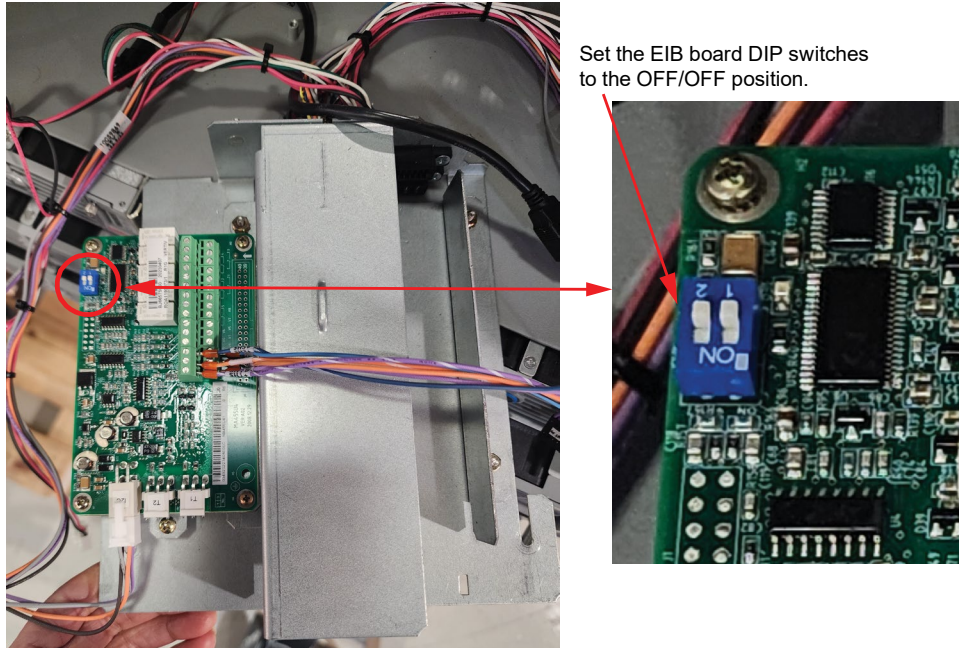

- [] 2. Connect the connectors J2, J11, and J8 on the INTERFACE board with the mating connectors (match by label markings) of the NCU assembly. See Figure 1.26.

Figure 1.26 Connections of NCU Plate Assembly to the INTERFACE Board

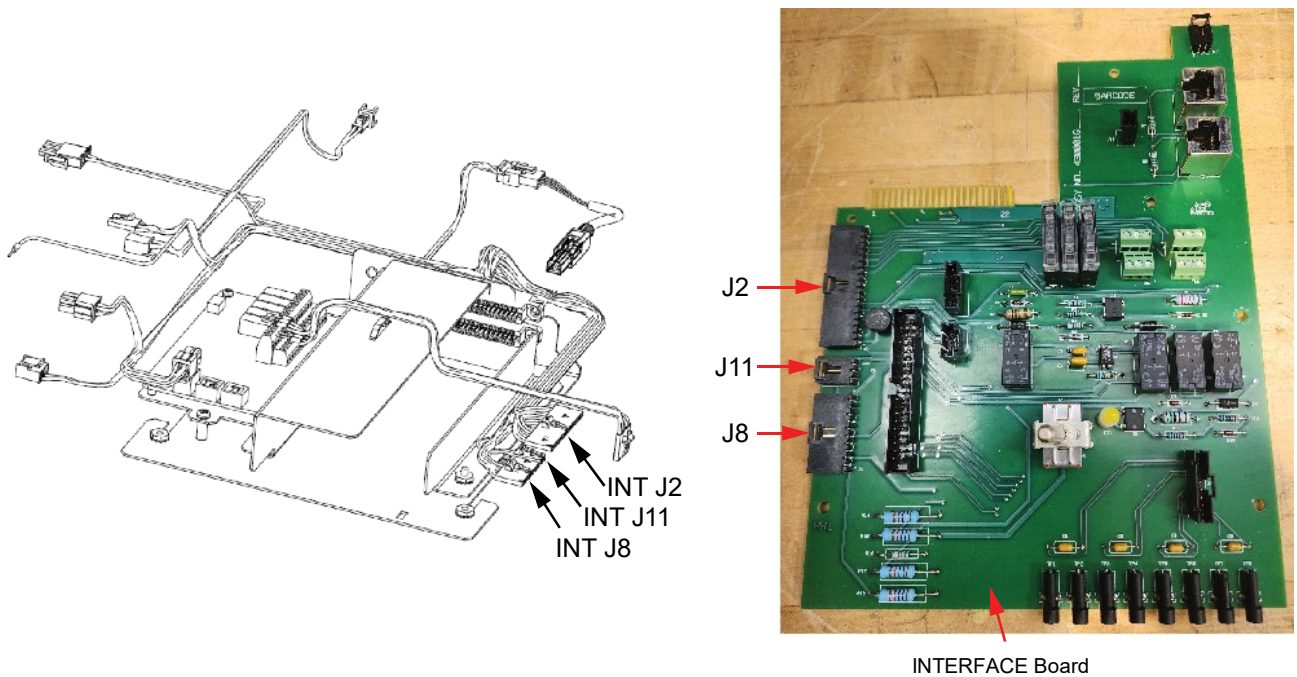

- [] 3. Slide in the NCU plate assembly between the two studs and ensure the USB cable is routed as shown in Figure 1.27. The connector on the open end of the USB cable will be connected to the IB4 assembly which will be installed in the later steps. Secure the NCU plate assembly with the provided two (2) #6-32 keps nuts using a 1/2-inch nut driver.

Figure 1.27 Installing the NCU Plate Assembly

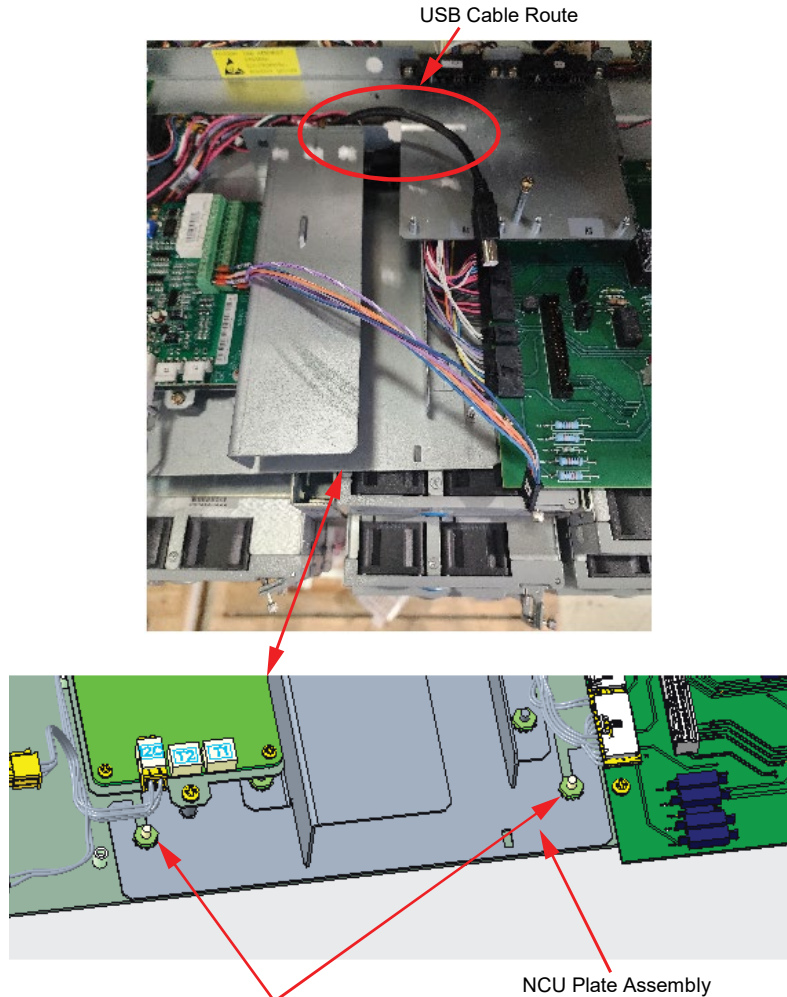

Slide in the NCU plate assembly between the two studs and ensure the USB cable is routed as shown above. Secure the NCU plate assembly with the provided two (2) #6-32 keps nuts using a 1/2-inch nut driver.

- [] 4. Secure the connector that was removed in step 9a or 10 (see Figure 1.6 on page 11) to its mating connector (labelled FRS on the NCU plate assembly harness) as shown in Figure 1.28.

Figure 1.28 Securing the Connector

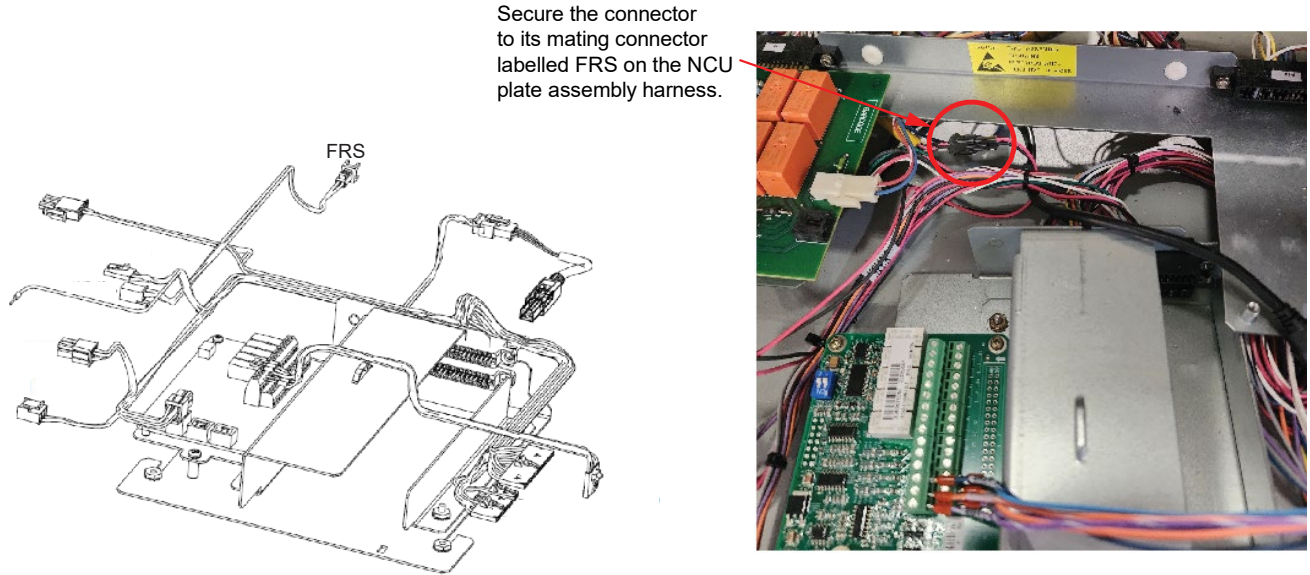

- [] 5. Plug in the 4-position black connector (labelled LVD J2 on the NCU plate assembly harness) to the J2 connector on the LVD board. See Figure 1.29.

Figure 1.29 4-Position Black Connector Plug In

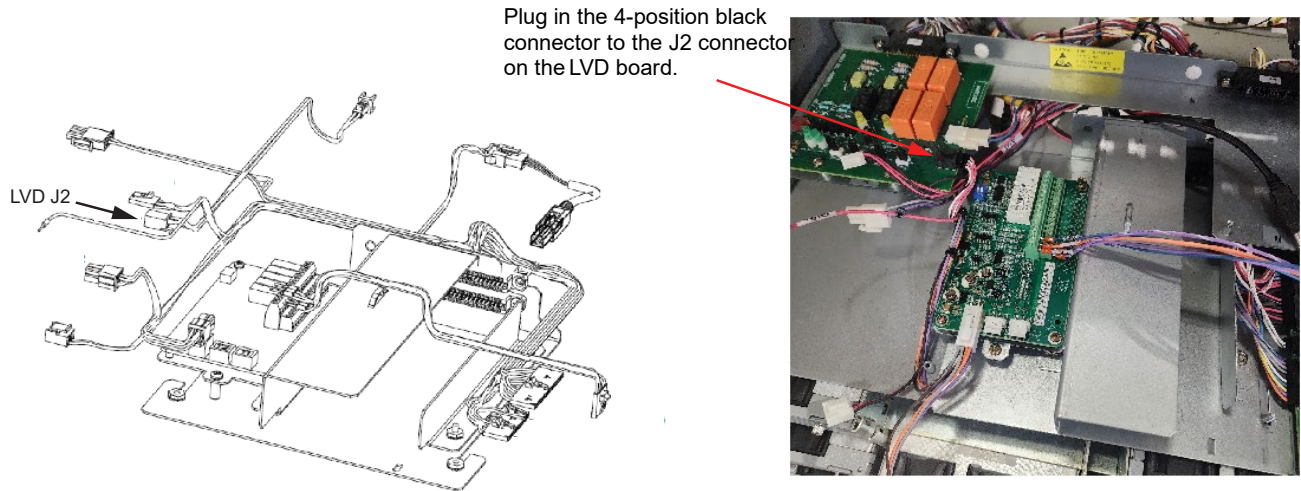

- [] 6. Connect the other end of the EIB cable to the J9 on the INTERFACE board. See Figure 1.30.

Figure 1.30 Connecting the Other End of the EIB Cable to the INTERFACE Board

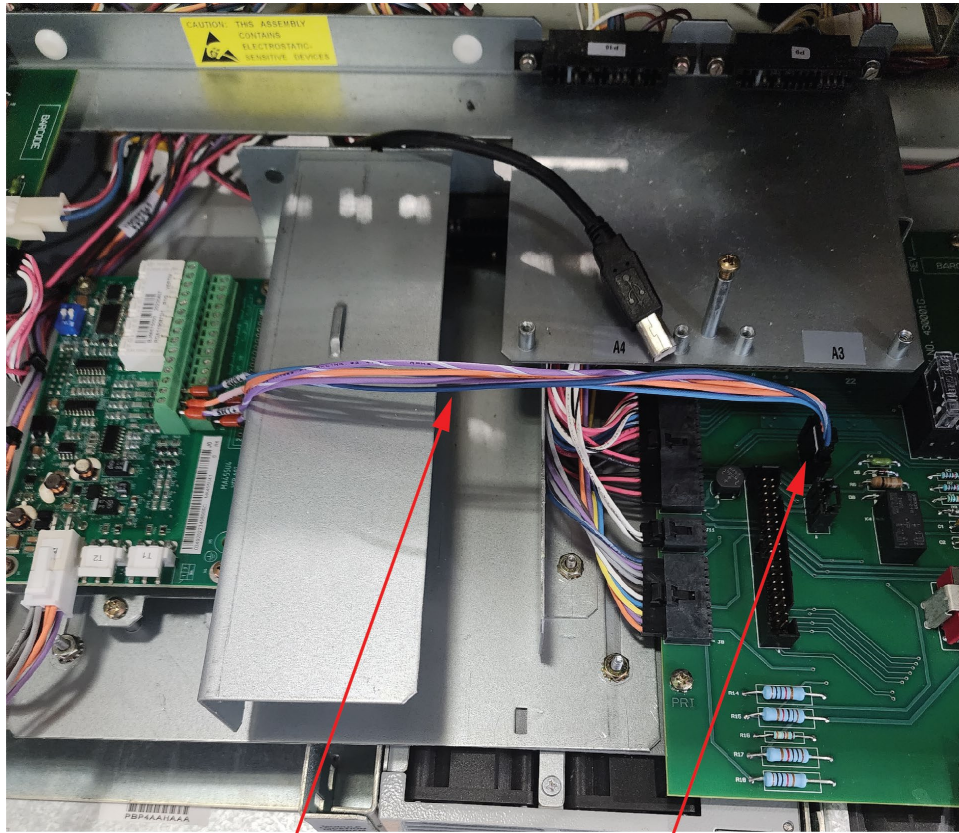

EIB Cable

Connect the other end of the EIB cable to the J9 on the INTERFACE board.

Installing the IB2 Board assembly (P/N 60121402) and Optional SMDU+ Assembly (P/N 60121401)

To install only the IB2 board assembly in the system, perform steps from 11 to 15 of this section.

If the optional SMDU+ assembly is ordered for use with the retrofit kit, then, to install both the IB2 board assembly and the optional SMDU+ assembly, perform steps from 1 to 15 of this section.

- [] 1. Make sure that the DIP switch positions of the assembly are set as shown in the below Figure 1.31. Address is set on SW2 DIP 5, 6, and 7. Other positions to be OFF. Refer to Table 1.9 for SW2 settings.
- [] 2. SW1 is set to Address #1 but can be any desired address from 1 to 8 as long as it is a unique address.
- [] 3. When setting Address for SMDU+ in supplemental bays you must make sure the Address is not used in another bay.

Figure 1.31 DIP Switches Positions of SMDU+ Board (P/N SMDU2)

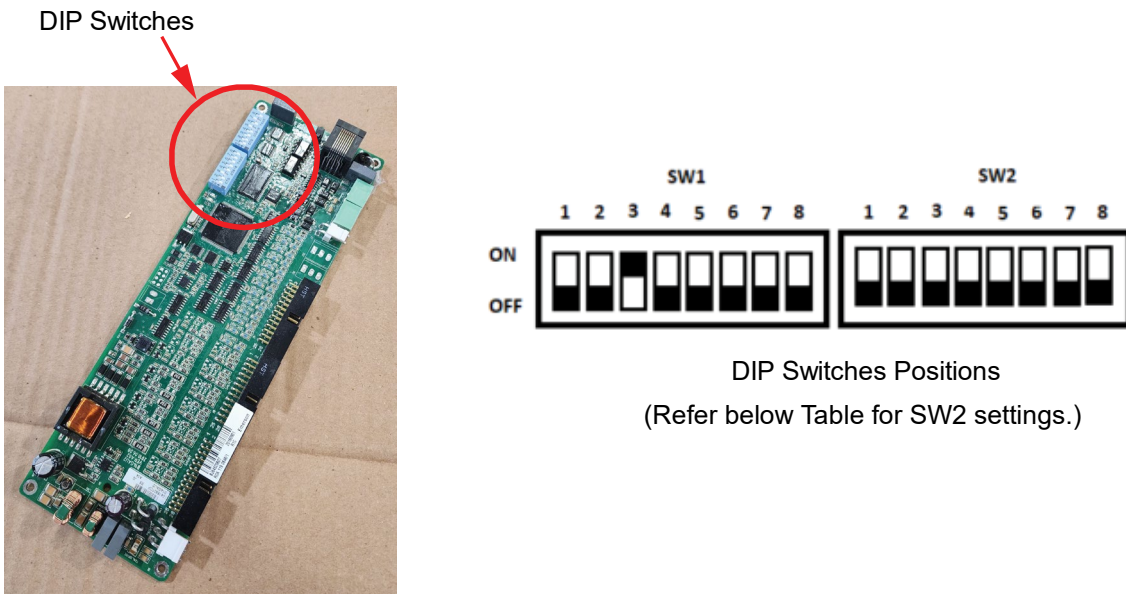
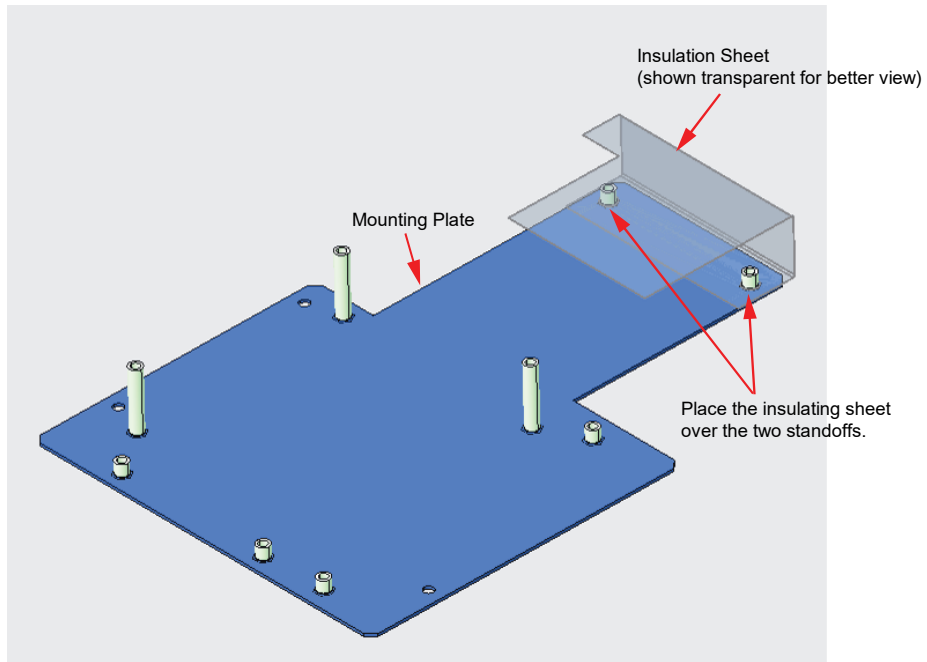

Table 1.9 Switch Settings

DIP Switch SW2			
Communications Address			Descriptions of Status
5	6	7	
OFF	OFF	OFF	Address 1#
OFF	OFF	ON	Address 2#
OFF	ON	OFF	Address 3#
OFF	ON	ON	Address 4#
ON	OFF	OFF	Address 5#
ON	OFF	ON	Address 6#
ON	ON	OFF	Address 7#
ON	ON	ON	Address 8#

- [] 4. Place the insulating sheet over the two standoffs of the mounting plate. See Figure 1.32.

Figure 1.32 Placing the Insulation Sheet to the Mounting Plate (part of P/N 60121402)



- [] 5. Install the SMDU+ board (P/N SMDU2) to the mounting plate with the provided four (4) #6-32 x 1/4" screws using a #2 Phillips head screwdriver. See Figure 1.33.

Figure 1.33 Installing the SMDU+ Board (P/N SMDU2)

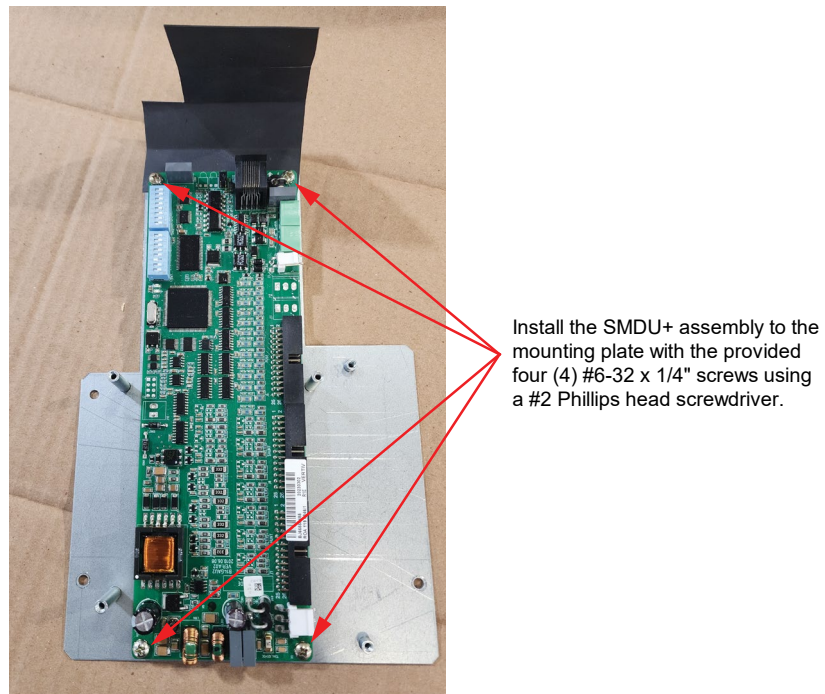

- [] 6. Plug in the two (2) ribbon cables of the shunt interface board (P/N 541277) to the corresponding connectors in the SMDU+ (P/N SMDU2) board as shown in Figure 1.34.

Figure 1.34 Connecting the Ribbon Cables of Shunt Interface Board (P/N 541277) to the SMDU+ Board (P/N SMDU2)

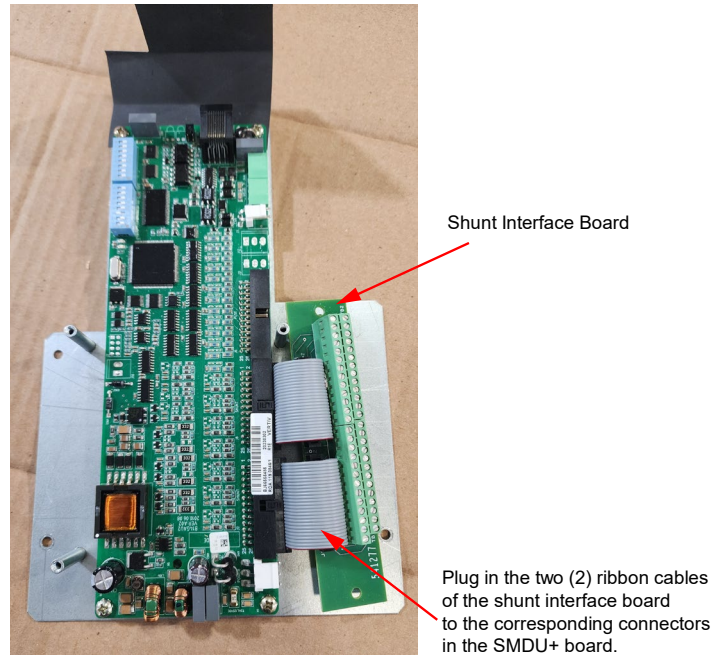

- [] 7. Install the shunt interface board (P/N 541277) to the mounting plate with the provided two (2) #6-32 x 1/4" screws using a #2 Phillips head screwdriver. See Figure 1.35.

Figure 1.35 Installing the Shunt Interface Board

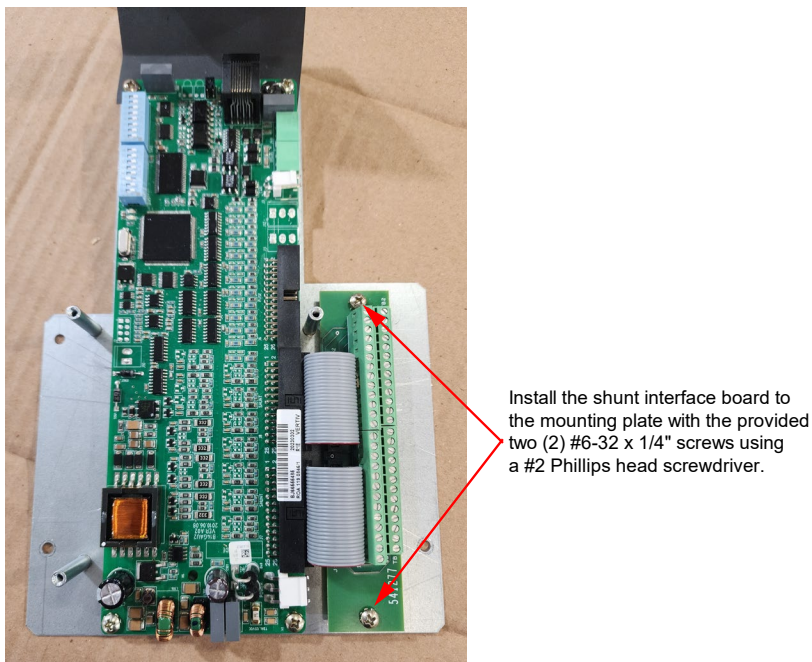

- [] 8. Connect the CAN connection of the SMDU+ (P/N SMDU2) to the corresponding connector from the NCU assembly (connector labelled SMDU+J3). See Figure 1.36.

Figure 1.36 CAN Connection of the SMDU+

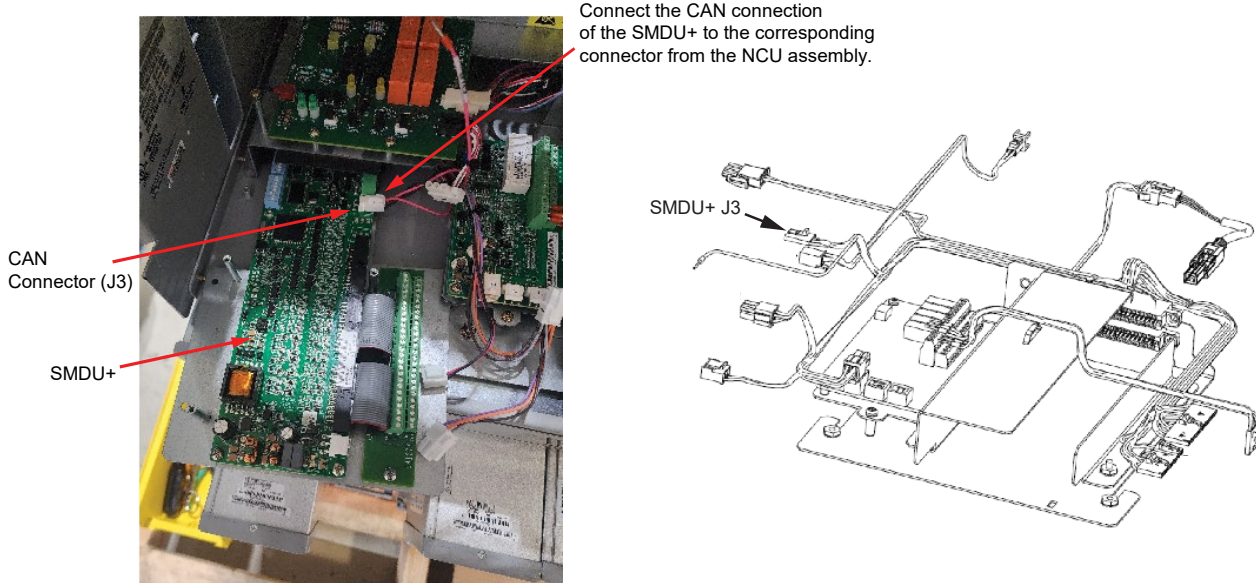

- [] 9. Secure the mounting plate to the base of the system with the provided three (3) #6-32 x 1/4" screws using a #2 Phillips head screwdriver. See Figure 1.37.

Figure 1.37 Installing the Assembly

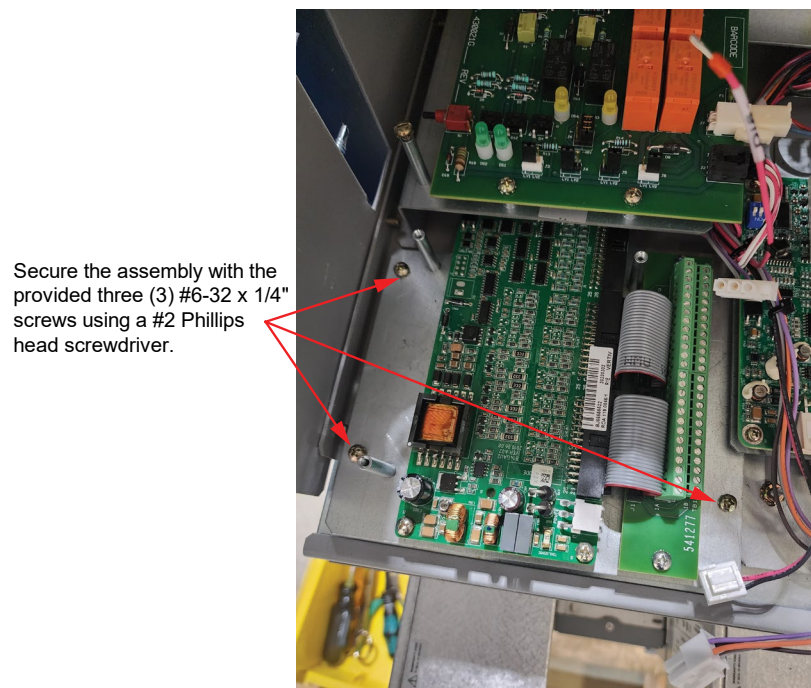

- [] 10. Connect the power connection of the SMDU+ (P/N SMDU2) to the corresponding connector from the NCU assembly (connector labelled SMDU+J1). See Figure 1.38.

Figure 1.38 Power Connections of SMDU+

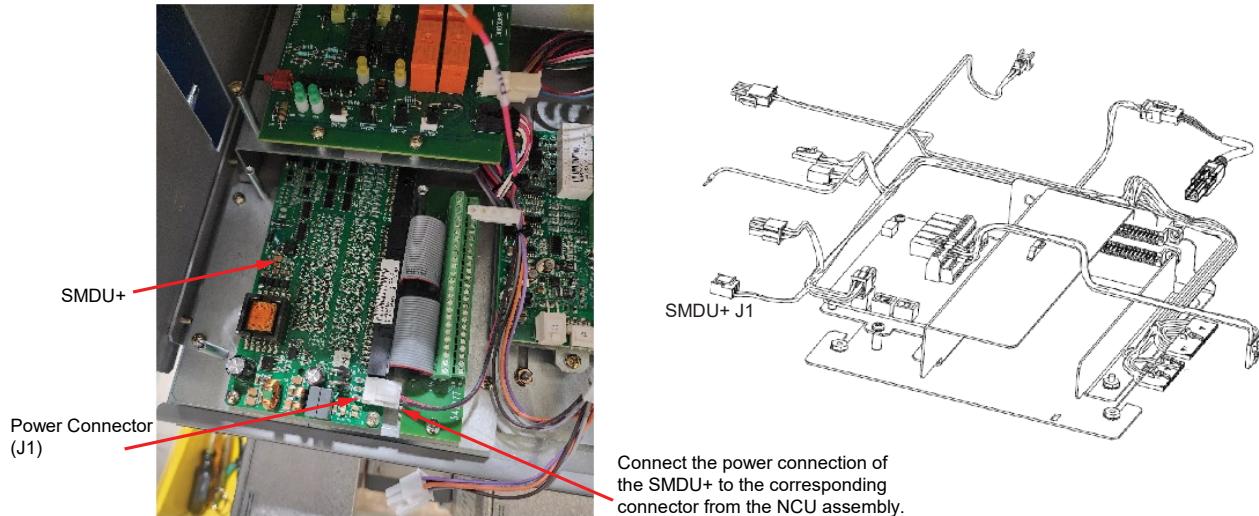

- [] 11. Set the IB2 board DIP switches to the OFF/OFF position. See Figure 1.39.



NOTE! If installing only the IB2 board (optional SMDU+ assembly is not ordered), also perform the below steps.

- Sleeve the connector labelled 'SMDU+J3' of the NCU plate assembly harness with the black shrink sleeving (P/N 73-78-440) provided in the kit using the ty wrap (do not use the heat gun).
- Secure only the mounting plate to the base of the system with the provided three (3) #6-32 x 1/4" screws using a #2 Phillips head screwdriver.
- Sleeve the connector labelled 'SMDU+J1' of the NCU plate assembly harness with the black shrink sleeving (P/N 73-78-440) provided in the kit using the ty wrap (do not use the heat gun).

Figure 1.39 Setting the IB2 Board DIP Switches

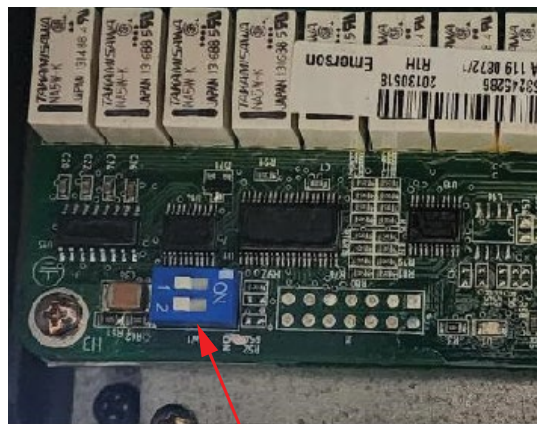

Set the IB2 board DIP switches to the OFF/OFF position.

- [] 12. Remove the three (3) #6-32 x 1/4" screws from the long standoffs using a #2 Phillips head screwdriver. See Figure 1.40.

Figure 1.40 Removing the Screws

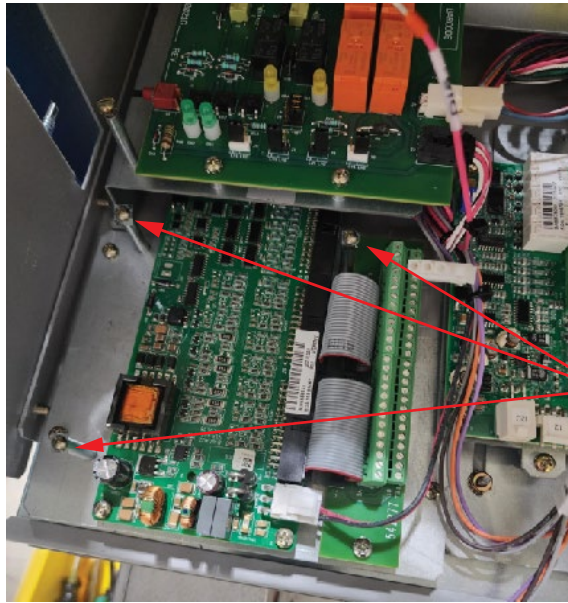

Remove these three (3) #6-32 x 1/4" screws from the long standoffs using a #2 Phillips head screwdriver.

- [] 13. Connect the wire to the DI8- location in a -48V system or DI8+ in a +24V system. See Figure 1.41.

Figure 1.41 Connecting the Wire

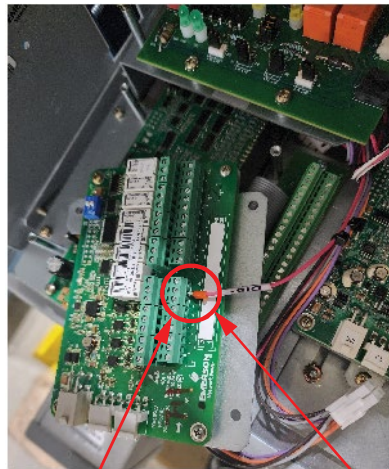

Connect the wire to the DI8- location in a -48V system.



Connect the wire to the DI8+ location in a +24V system.

- [] 14. Install the IB2 board assembly to standoffs with the three (3) #6-32 x 1/4" screws (removed in the above step) using a #2 Phillips head screwdriver. See Figure 1.42.

Figure 1.42 Installing the IB2 Board

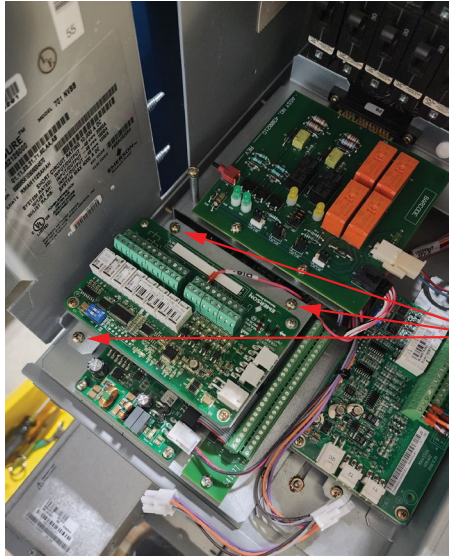

Install the IB2 board assembly to standoffs with the three (3) #6-32 x 1/4" screws (removed in the above step) using a #2 Phillips head screwdriver.

- [] 15. Connect the power and communication connector to the IB2 board. Install similar connector to the EIB board. See Figure 1.43.

Figure 1.43 Connecting Power and Communication Connector to the IB2 Board and EIB Board

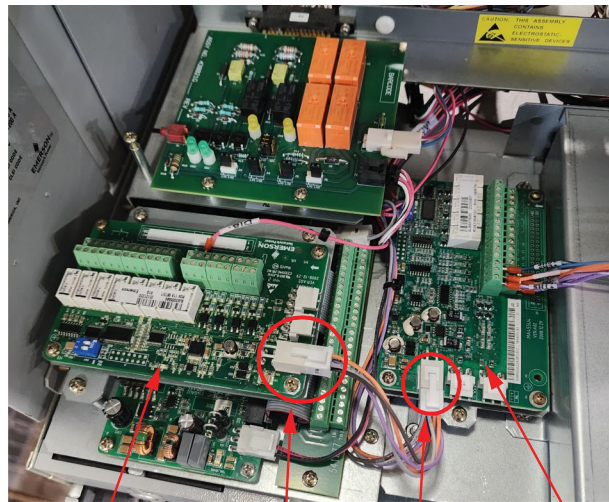

IB2 Board

EIB Board

Connect the power and communication connector to the IB2 board.

Install similar connector to the EIB board.

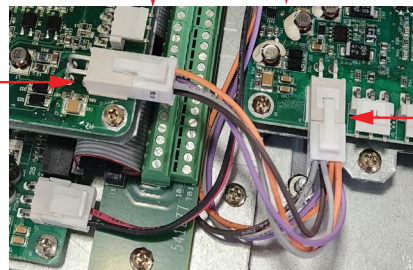

Installing the IB4 Board Assembly (P/N 60121198)

- [] 1. Install the IB4 board assembly with the provided two (2) #6-32 x 1/4" screws using a #2 Phillips head screwdriver and connect the other end of the USB cable to the IB4 board. See Figure 1.44.



NOTE! Make sure that the IB4 board is placed from underneath the EIB cables that are routed to the INTERFACE board.

Figure 1.44 Installing the IB4 Board Assembly



IB4 Board Assembly

1. Install the IB4 assembly with the provided two (2) #6-32 x 1/4" screws using a #2 Phillips head screwdriver.

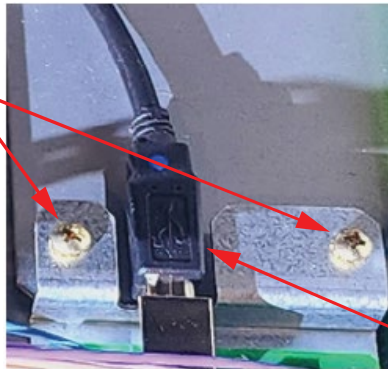

2. Connect the other end of the USB cable to the IB4 board.

Installing the Front Plate (P/N 60121478)



NOTE! While installing the front plate, make sure that the insulation piece is adhered to the inside of the bottom flange.

- [] 1. Loosen the two (2) #6-32 keps nuts that secure the NCU plate assembly using a 1/2-inch nut driver tool and slide the front plate between the two studs on top of the NCU mounting plate. Tighten the keps nuts using the same tool. See Figure 1.45.

Figure 1.45 Installing the Front Plate

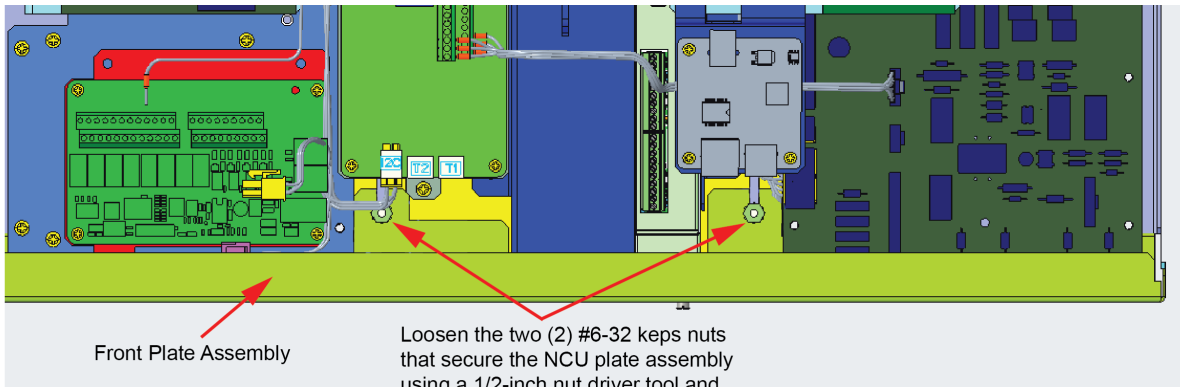

Loosen the two (2) #6-32 keps nuts that secure the NCU plate assembly using a 1/2-inch nut driver tool and slide the front plate between the two studs on top of the NCU mounting plate. Tighten the keps nuts using the same 1/2-inch nut driver tool.

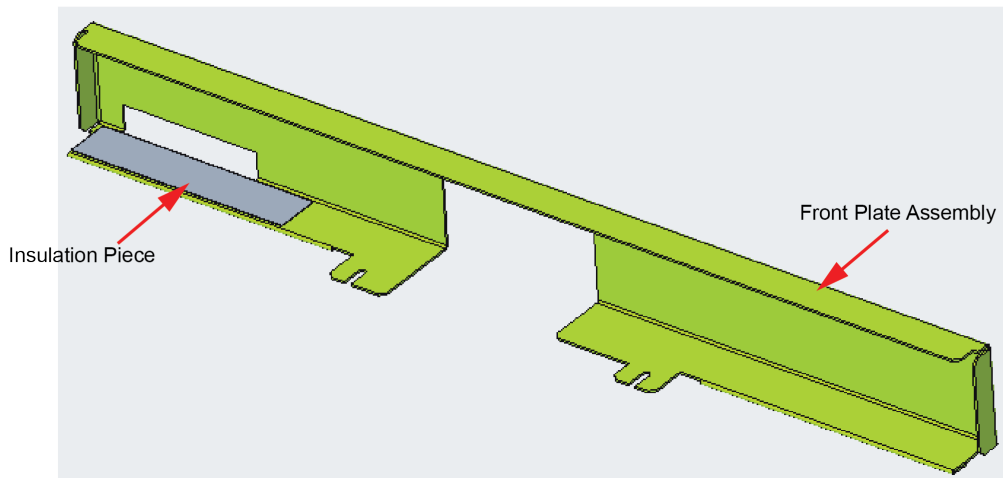

Installing the SHUNT I/O Board (P/N 430011G1)

1. To install the SHUNT I/O board, perform the procedure in Figure 1.46.

Figure 1.46 Installing the SHUNT I/O Board

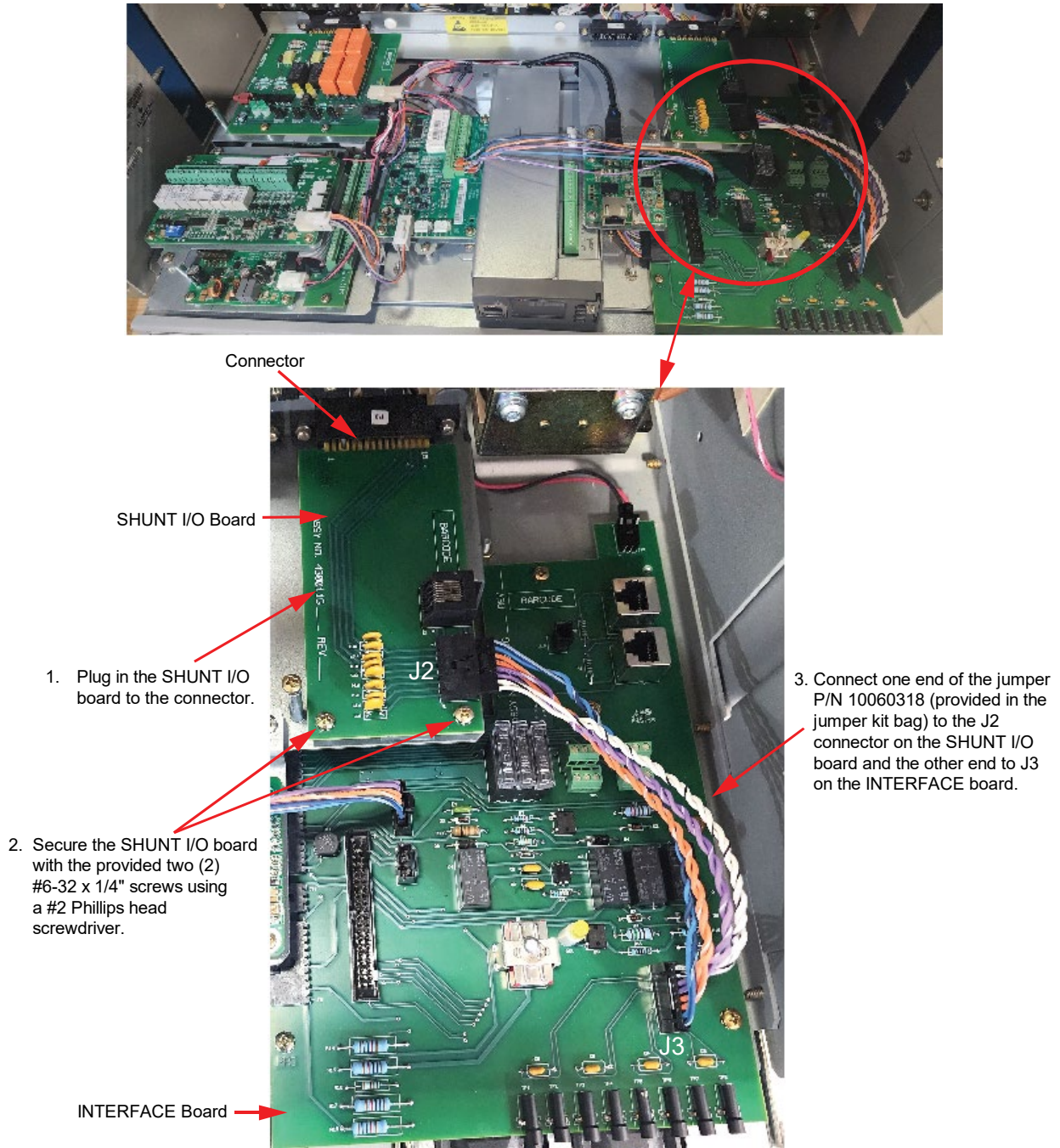

Installing the Jumper (If System Equipped with Battery Shunt Option)

1. Connect the jumper P/N 10060319 from J10 on the INTERFACE board through the back of the system and connect spade lugs on the battery shunt. Sleeve old wires on shunt. See Figure 1.47.

Figure 1.47 Installing the Jumper

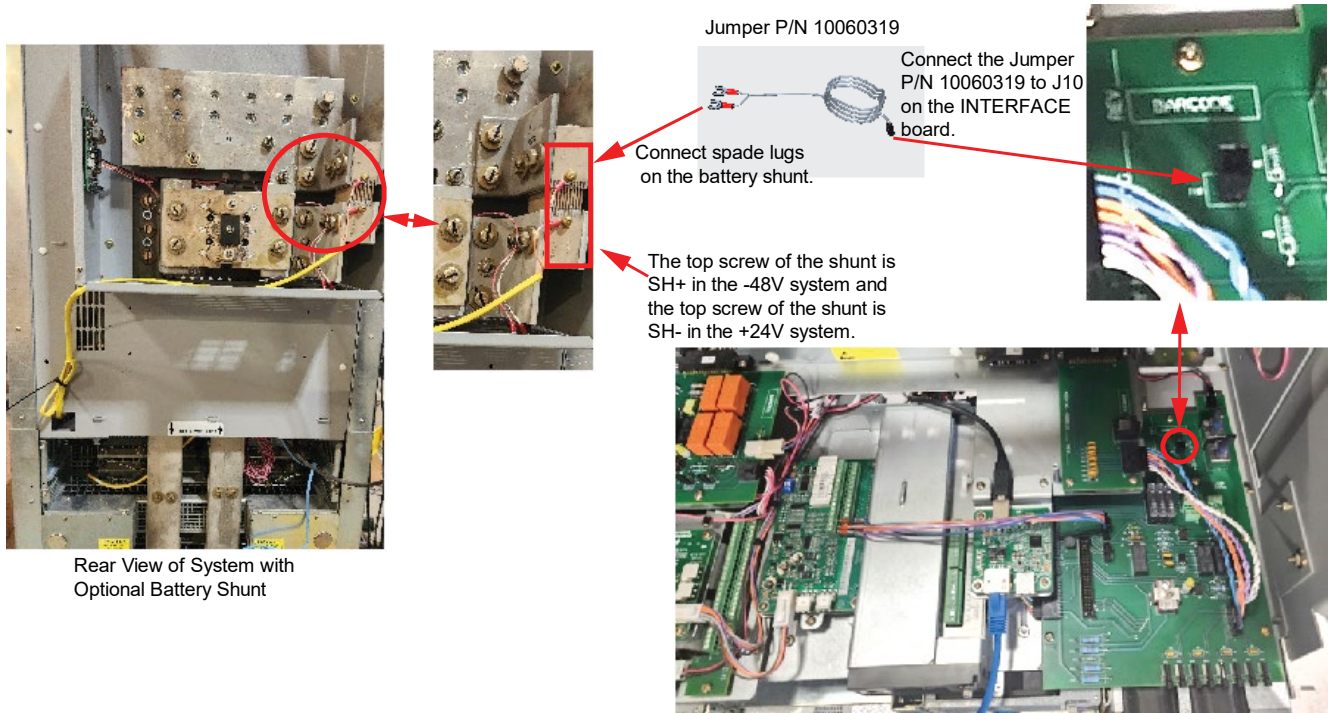

Rear View of System with Optional Battery Shunt

Installing the Jumper (If System Equipped with Manual Battery Disconnect (MBD) Option)

1. Connect one end of jumper P/N 10063152 (provided in the jumper kit bag) to the main harness connector labelled MBD and the other end to the existing jumper connector located at the top of the system as shown in Figure 1.48.

Figure 1.48 Installing the Jumper

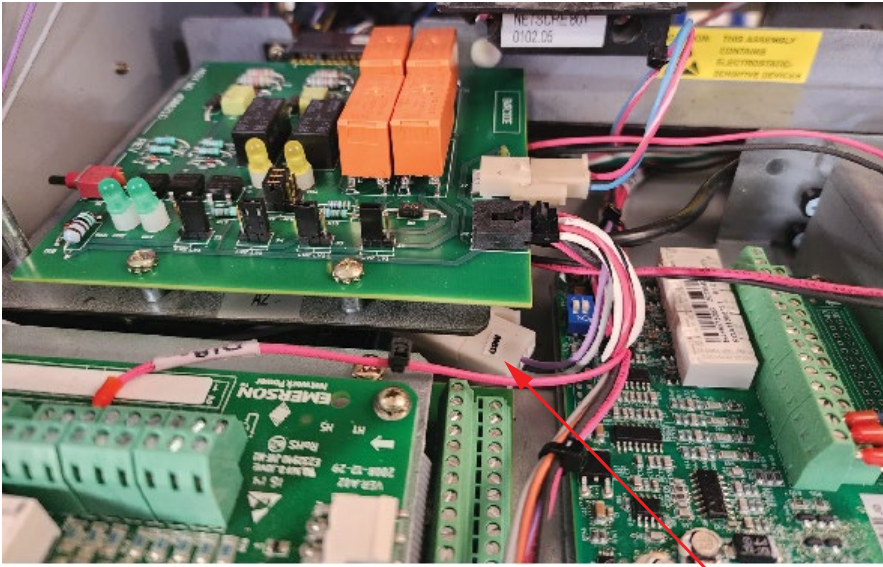

1. Connect one end of jumper P/N 10063152 (provided in the jumper kit bag) to the main harness connector labelled MBD.

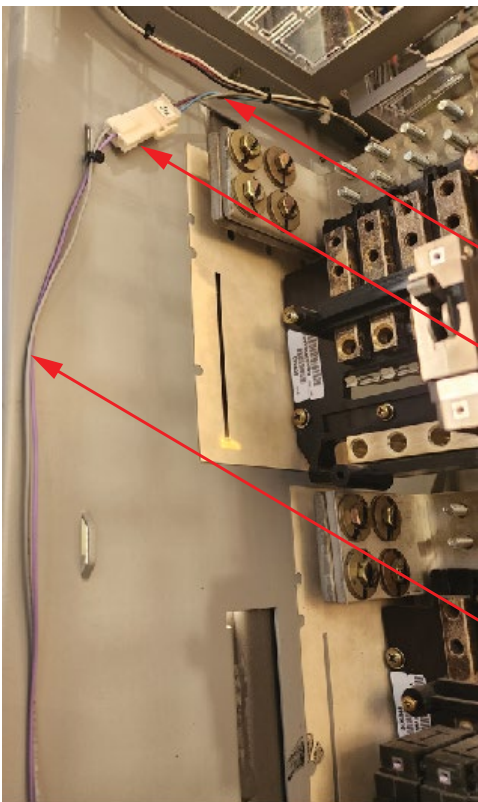

Existing cable in the system

2. Connect the other end of jumper P/N 10063152 to the existing jumper connector located at the top of the system as shown.

Jumper P/N 10063152

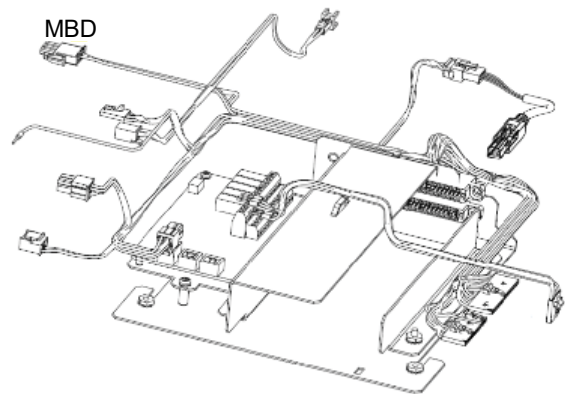

Installing the Fuses and Terminators on the INTERFACE Board

- [] 1. Install the fuses (that were removed from the new INTERFACE board in Figure 1.19) and terminators (provided in the jumper kit bag) on the INTERFACE board. See Figure 1.49. Fuses are for auxiliary power. Refer to the “INTERFACE board” section in the Retrofit Kit User Manual (UM60124057) for more information.

Figure 1.49 Installing the Fuses and Terminators

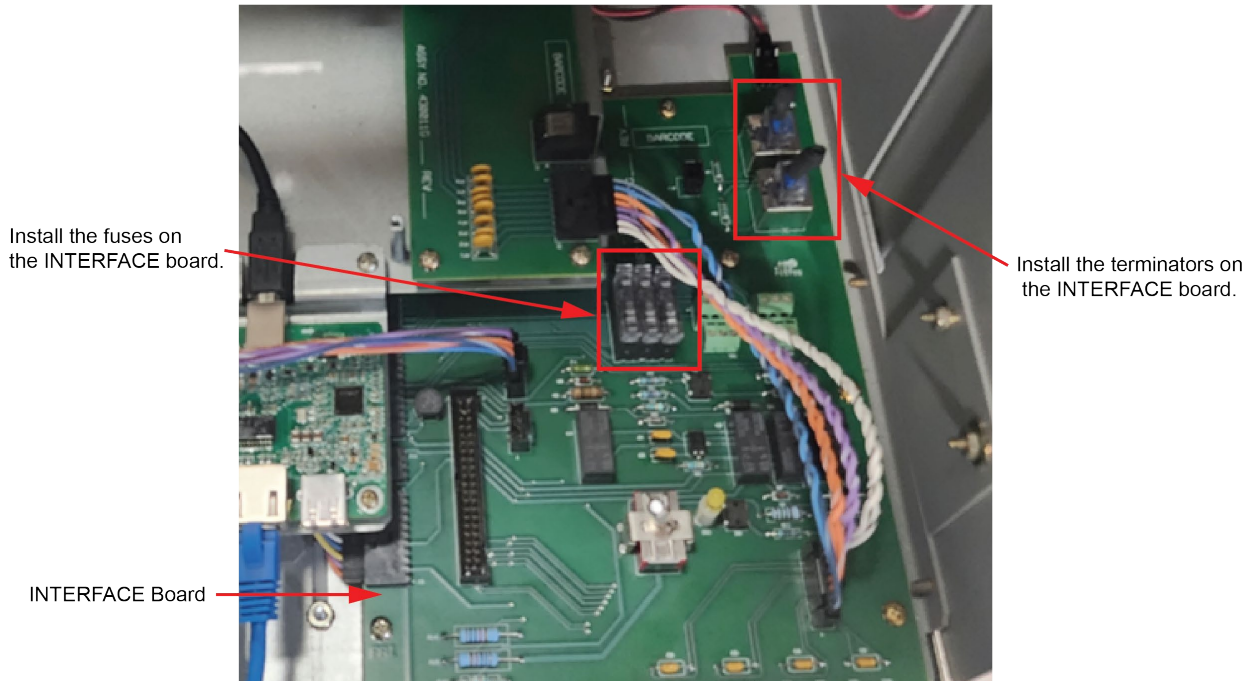

Refer to the “IB2 (Controller Interface Board) Connections (if required) (Main Bay Only)” section in the Retrofit Kit User Manual (UM60124057) to connect any wires that were removed from the old INTERCONNECT card to the new INTERFACE board.

Adhering Labels

- [] 1. Select the retrofit labels based on the retrofitted system (701NVBB or 700NVBA). See Figure 1.50.

Figure 1.50 Labels

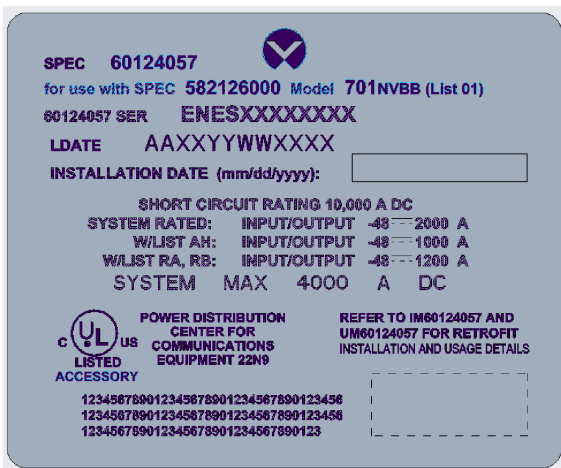

Label for NetSure™ 701NVBB DC Power System

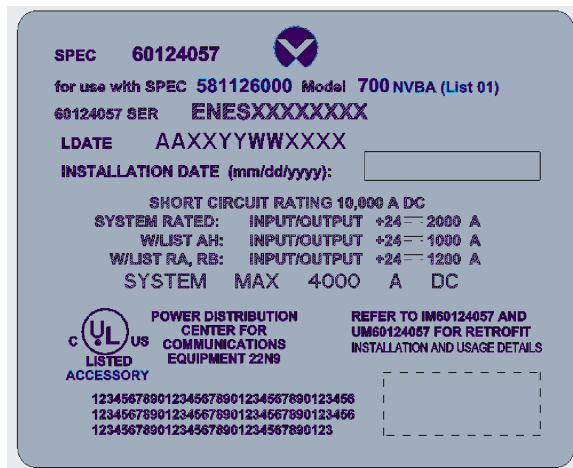

Label for NetSure™ 700NVBA DC Power System

- [] 2. Adhere the selected labels in the specific locations as shown in Figure 1.51. Use a permanent marker to write the Installation date in the appropriate field of the labels. The remaining labels to be discarded along with the carton.

Figure 1.51 Location for the Labels

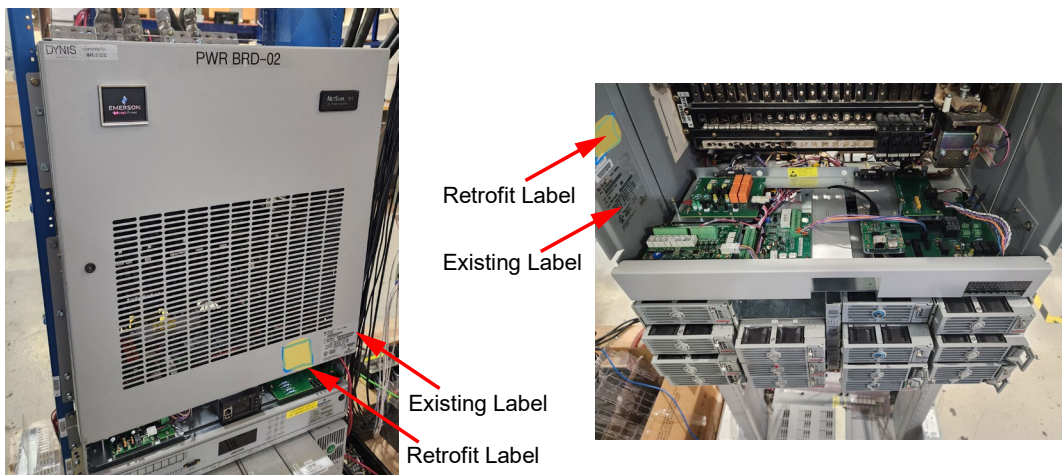
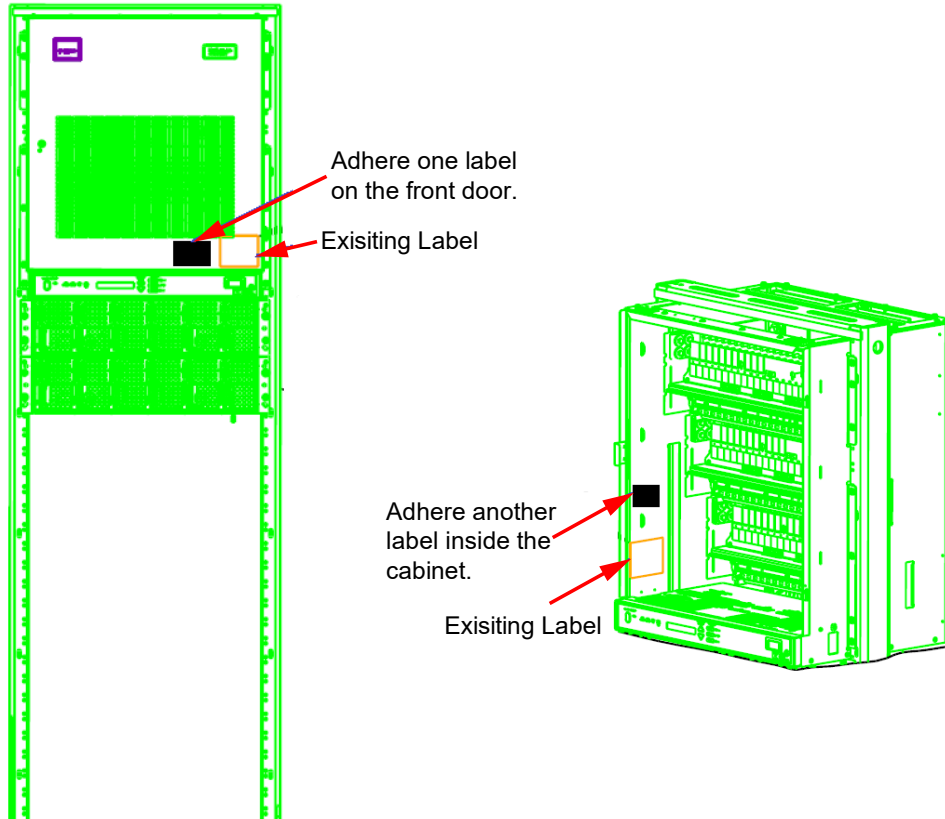

Final Procedure

If supplemental bay retrofit kit is not required:

- [] 1. From the kit, take out the lexan panel (P/N 60128403) and align its keyholes with the loosened screws (see Figure 1.4). Slide the lexan panel inwards (to the end of the keyholes) and tighten the two (2) #6-32 x 1/2" Phillips head screws using a #2 Phillips head screwdriver. See Figure 1.52.

Figure 1.52 Installing the Lexan Panel

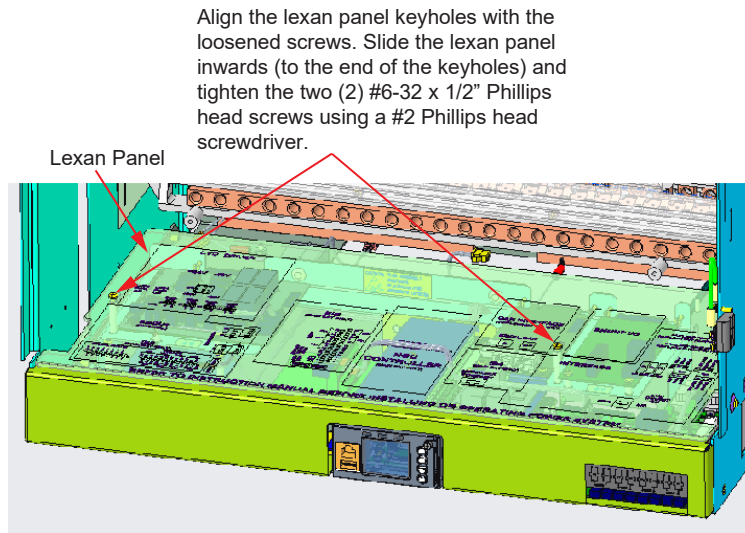

- [] 2. Close the front door. The door latch automatically gets engaged and it secures the door.
- [] 3. Proceed to section “Installing the NCU Controller” on page 75 installing the controller.
- [] 4. Refer to the Retrofit Kit User Manual (UM60124057) for the controller programming information.

If supplemental bay retrofit kit is required:

- [] 1. Refer to the “Vertiv™ NetSure™ Control Unit (NCU) Retrofit Kit (Supplemental Bay) Installation Instructions” on page 42 to install the Supplemental Bay retrofit kit in the supplemental bay.
- [] 2. Refer to the Retrofit Kit User Manual (UM60124057) for the bay-to-bay connections information.
- [] 3. Install the Lexan panel. See Figure 1.52.
- [] 4. Close the front door. The door latch automatically gets engaged and it secures the door.
- [] 5. Proceed to section “Installing the NCU Controller” on page 75 to install the controller.
- [] 6. Refer to the Retrofit Kit User Manual (UM60124057) for the controller programming information.

2 Vertiv™ NetSure™ Control Unit (NCU) Retrofit Kit (Supplemental Bay) Installation Instructions



NOTE! This chapter is applicable for installing the retrofit kit in the supplemental bay. If you are not installing this kit in the supplemental bay, go to chapter 3 “Installing the NCU Controller” on page 75.

2.1 Kit Description

These instructions provide a step-by-step procedure to field install this kit into a Vertiv™ NetSure™ 701 Series DC Power System (Spec. No. 582126000, Supplemental Bay). Installation of this kit in other equipment should not be attempted.

2.2 Kit Contents of P/N 60135833

Table 2.1 lists the items furnished as a part of this kit. Before installing the kit, check the items furnished against those listed to ensure that there are no shortages.

Table 2.1 Kit Contents

P/N	Description	Qty.
430021G1	LVD Driver Board	1
430001G1	INTERFACE Board	1
524410	Cable Assy, RS-485, 8 COND, 24"	1
10060005	-48V Supplemental Bay Harness, Kit (this kit includes items with ***)	1
*** 10060318	Jumper, Interface, Shunt	1
*** 10060320	Jumper, Interface, Last Rectifier Shelf	1
*** 10060323	Assembly, -48V Supplemental Bay, Harness	1
*** 10063153	Jumper, CAN Input, w/connectors (Option-1)	1
*** 10063154	Jumper, CAN Input, Splicing (Option-2)	1
*** 60150618	Label, Name Plate, Supplemental Bay	2
*** 73-78-440	Shrink Sleeving, Size 3/4in.	12 inches
*** 237650200	Cable Tie, 3-7/8" Long	6
*** 225120700	Screw, Phil PH 6-32 x 1/2" Screws (additional hardware)	2
*** 233394000	Screw, Phil PH 6-32 x 1/4" Screws (additional hardware 4 qty)	7
60122807	SMDU Assembly	1
430011G1	SHUNT I/O Board	1
430161G1	CAN INTERFACE Board	1
60122808	Front Plate	1
60128403	Lexan Panel	1
10062782	IDC Socket and Terminal Cable	1
60121399	Support Plate, SMDU+	1

Additional Items (not included in kit, ordered separately)		
P/N	Description	Qty.
60121401	SMDU+ Assembly, Internal (optional) (this kit includes items with ***)	1
***SMDU2	SMDU+	1
***541277	Assembly, Shunt Interface Board	1
***60131605	Insulation Piece, SMDU+	1
***233394000	Screw, Phil PH 6-32 x 1/4in (additional hardware)	6

2.3 Tools and Material Required

Table 2.2 lists the items required to install this kit.

Table 2.2 Tools and Material Required

Description
Flat head screwdriver
1/2-inch Nut Driver
#2 Phillips Screwdriver
3 mm Slotted Screwdriver
Stripper
Ty wrap Cutter

2.4 Recording LVD Switch Settings

Manually record the original LVD card switch settings (if applicable) in Table 2.3. Refer to Figure 2.1 for the location of switches S1–S4 on the LVD card and refer to Table 2.4 for the LVD card voltage switch setting.

Table 2.3 Original LVD Card Switch Settings

Switch Number	Distribution Row	Section 1 Setting (ON or OFF)	Section 2 Setting (ON or OFF)
S1	Row 1 (Bottom)		
S2	Row 2		
S3	Row 3		
S4	Row 4		

Figure 2.1 Original LVD Card Switches S1-S4 Location

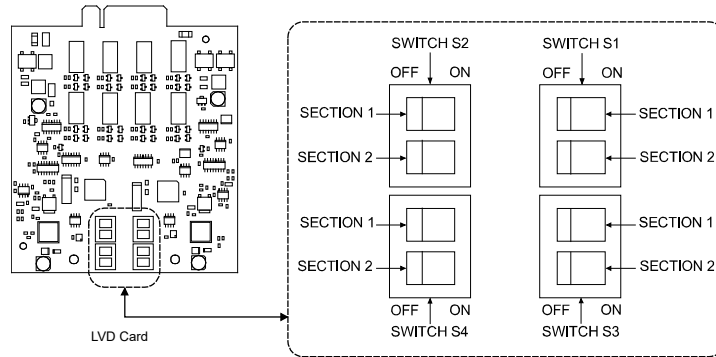

Table 2.4 Original LVD Card Disconnect Voltage Based on Switch Settings

LVD Voltage Setting	Section 1 Setting	Section 2 Setting
Disabled	OFF	OFF
LVD1	OFF	ON
LVD2	ON	OFF
LVD3	ON	ON

2.5 Installation Procedure

THESE INSTRUCTIONS SHOULD BE READ THROUGH COMPLETELY BEFORE INSTALLING THE KIT.

The following is a step-by-step procedure to install the kit. The procedure has been written for ease of use and to minimize the possibility of contact with potentially hazardous energy. This procedure should be performed in the sequence given, and each step should be completely read and fully understood before performing that step. Observe all “Important Safety Instructions” starting on page vi and also those presented in the following procedure. As each step of the procedure is completed, the box adjacent to the respective step should be checked. This will minimize the possibility of inadvertently skipping any steps. If the step is not required to be performed for your site, also check the box to indicate that it was read.



DANGER! This kit can be installed with the system operating. Observe the “Important Safety Instructions” starting on page vi and those listed in the power system manual.



CAUTION! When performing any step in procedures that requires removal or installation of hardware, use caution to ensure no hardware is dropped and left inside the unit; otherwise service interruption or equipment damage may occur.



NOTE! When performing any step in this procedure which requires removal of existing hardware, retain all hardware for use in subsequent steps, unless otherwise stated.

Items to be Removed (May Vary Based on Configuration)

See Figure 2.2 for the items that needs to be removed from the existing system before the installation of this kit.

Figure 2.2 Items to be Removed (May Vary Based on Configuration)

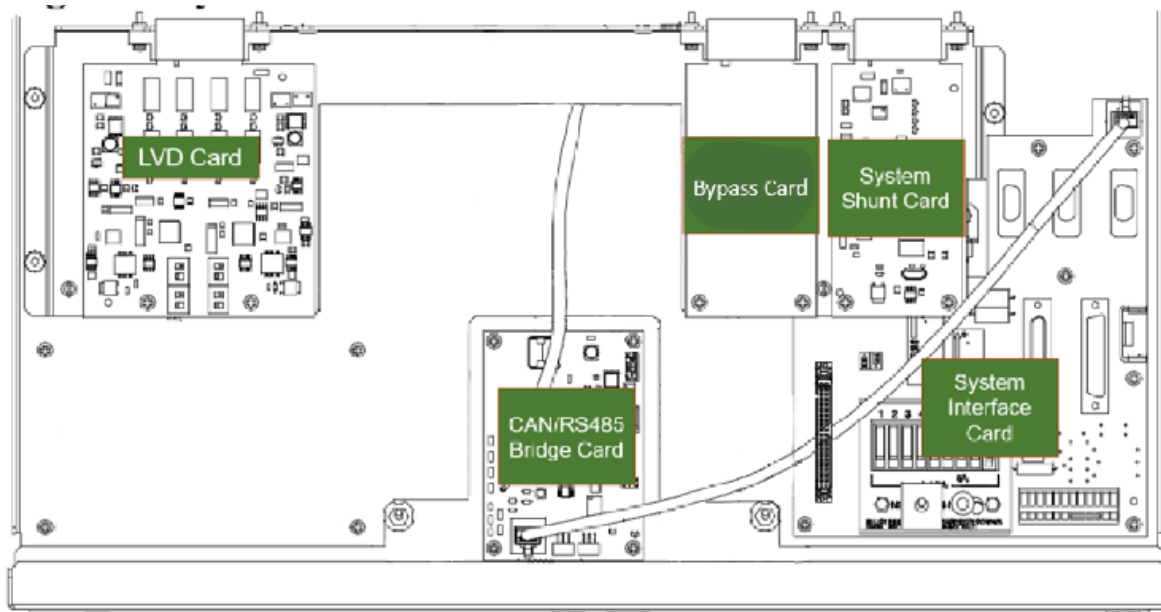

Initial Procedure

- [] 1. Performing this procedure may activate external alarms. Do one of the following. If possible, disable these alarms. If these alarms cannot be easily disabled, notify the appropriate personnel to disregard any future alarms associated with this system while the procedure is being performed.

- [] 2. Open the front door of the bay by turning the latch in the counterclockwise direction using a flat head screwdriver. See Figure 2.3.

Figure 2.3 Opening of the Front Door

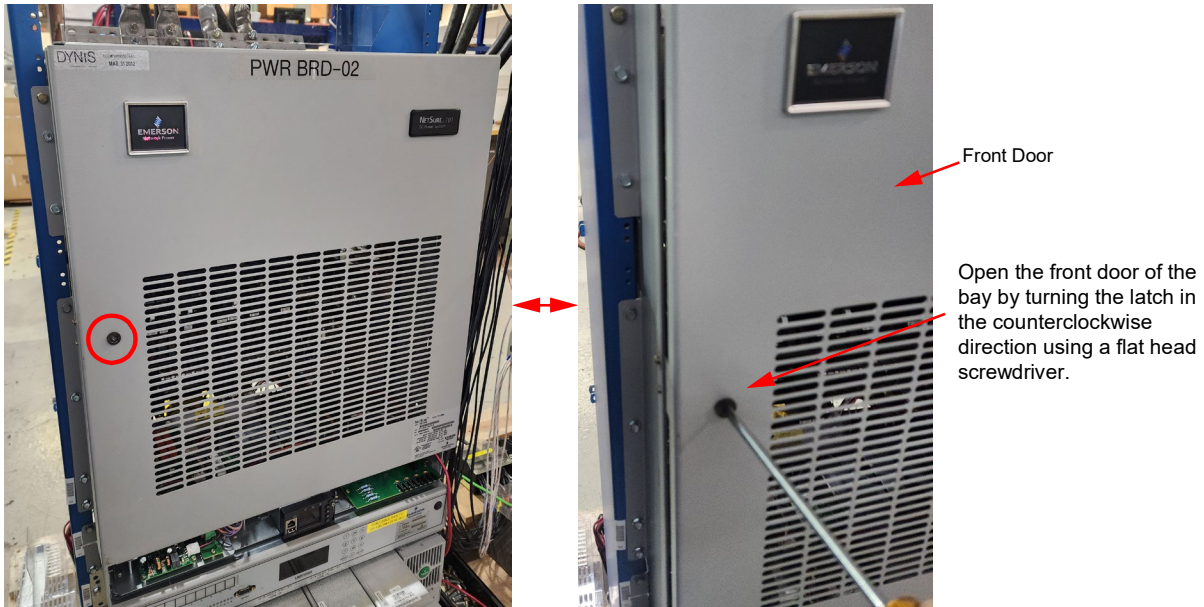

Removing the Front Plate Assembly

- [] 1. Loosen the two (2) #6-32 x 1/2" screws that secure the lexan panel using a #2 Phillips head screwdriver. Slide the lexan panel towards the front side of the system and lift the lexan panel through its key holes. See Figure 2.4.

Figure 2.4 Removing the Lexan Panel

Loosen the two (2) #6-32 x 1/2" screws that secure the lexan panel using a #2 Phillips head screwdriver. Slide and lift the lexan panel through its key holes.

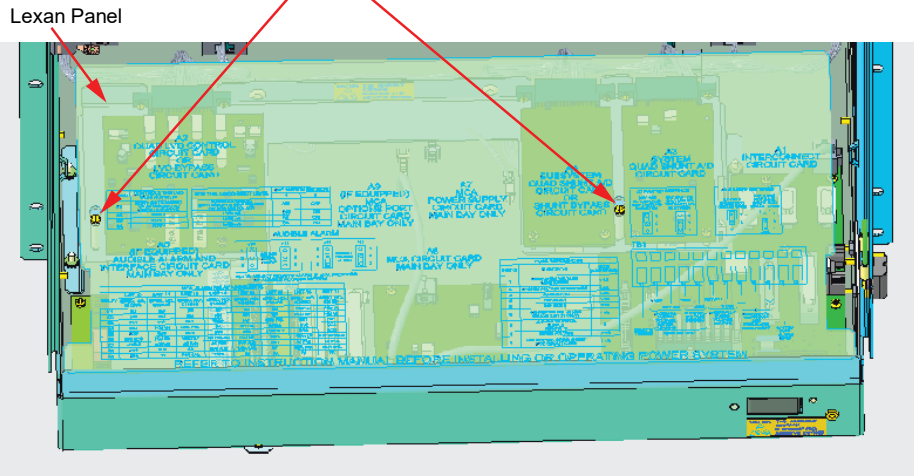

- [] 2. Turn on the inhibit switch on the INTERCONNECT card. Make sure that the yellow LED is “ON”. See Figure 2.5.



NOTE! If the inhibit switch for LVDs is not turned on, then they could disconnect and drop the loads.

Figure 2.5 The Inhibit Switch Location

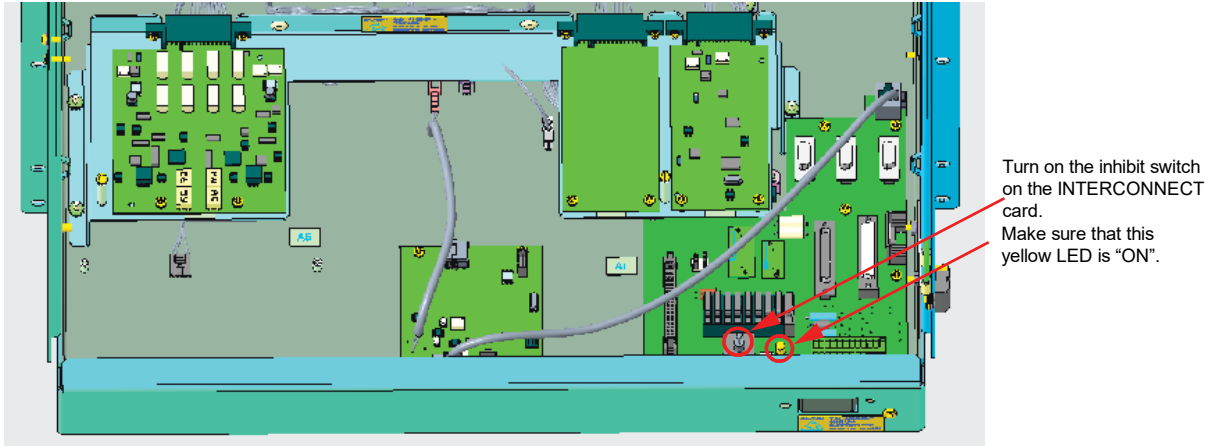

- [] 3. Disconnect the cables. See Figure 2.6.



NOTE! Some cables/connections may not be present depending on the original system configuration.

Figure 2.6 Disconnecting the Cables (cont'd on next page)

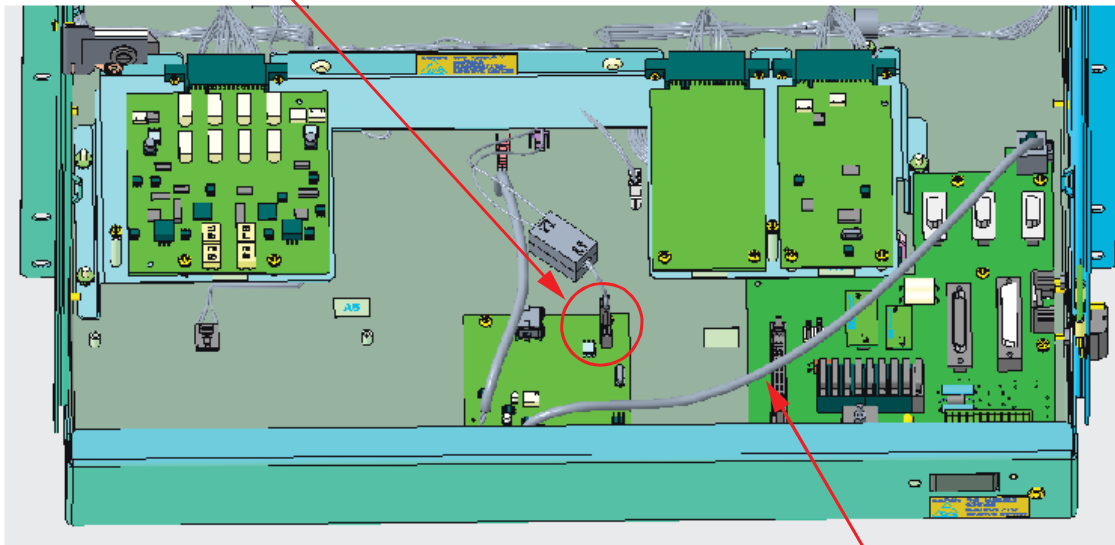
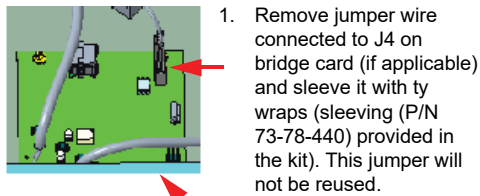

2. Remove this cable.

Figure 2.6 Disconnecting the Cables (cont'd from previous page)

- 3a. If reachable, unplug this connector (mating connector not shown). If this connector is unreachable, perform the step 4.
- 3b. Move mating connector cable towards the front side of the system.

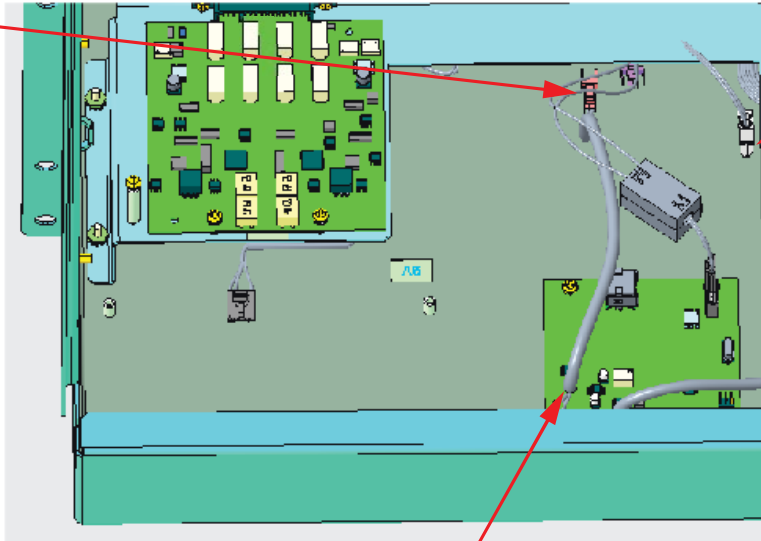

5. This connector J15 will be plugged into the new LVD board in the later steps. Keep this connector accessible.

4. If the connector is unreachable in step 3a, cut these wires from the PCB and join them with the jumper P/N 10063154 using the provided splices and heat shrink. (if heat gun is available) or using sleeving and ty wraps provided in the kit.

Jumper P/N 10063154 Splicing Procedure

- Cut the wires (red and black) as close to the bridge card as possible
- Open the jumper bag labelled P/N 10063154 and take out the jumper, splices, and heat shrink (to use if heat gun is available). Alternatively, have the sleeving and ty wraps provided with the kit accessible

Using heat shrink:

- Slide one piece of heat shrink on to one of the wires of P/N 10063154.
- Insert the red color wire from P/N 10063154 into one side of splice and the red wire from the yellow jacketed cable into the other side of the splice and crimp both sides of the splice using a crimping tool.
- Slide the heat shrink onto the splice and seal it by using a heat gun.
- Repeat the same for joining the black wires using another splicer and heat shrink piece.

Using the black shrink sleeving (P/N 73-78-440 provided in the kit) :

- Cut 1 inch of black shrink sleeving and slide it on to one of the wires of P/N 10063154.
- Insert the red color wire from P/N 10063154 into one side of splice and the red wire from the yellow jacketed cable into the other side of the splice and crimp both sides of the splice using a crimping tool.
- Slide the black shrink sleeving onto the splice and seal it by using ty wraps on both sides of the sleeve (do not use the heat gun).
- Repeat the same for joining the black wires using another splicer and heat shrink piece.

- [] 4. Remove the two (2) #6-32 Keps nuts that secure the front plate assembly using a #2 Phillips head screwdriver. See Figure 2.7. Pull out the front plate assembly from the system.

Figure 2.7 Removing the Front Plate Assembly

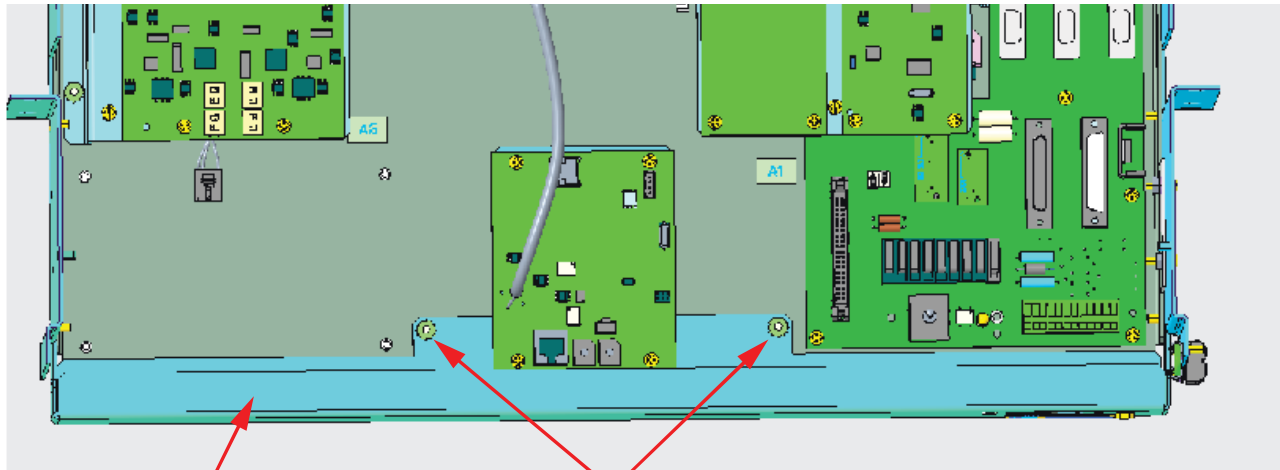

Front Plate Assembly

Remove these two (2) #6-32 keps nuts that secure the front plate assembly using a #2 Phillips head screwdriver and pull out the front plate assembly from the system.

Removing the LVD Driver Board

- [] 1. Make sure that LVD switch settings are recorded in Table 2.3 If not, record the LVD switch settings.
- [] 2. Remove the two (2) #6-32 x 1/4" screws that secure the LVD driver board using a #2 Phillips head screwdriver and unplug the LVD driver board from the connector. See Figure 2.8.

Figure 2.8 Removing the LVD Driver Board

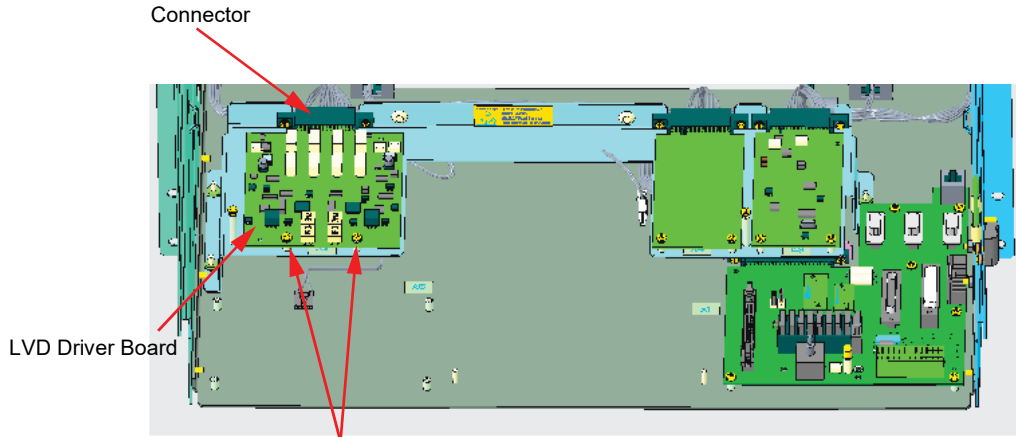

Remove these two (2) #6-32 x 1/4" screws that secure the LVD driver board using a #2 Phillips head screwdriver and unplug the LVD driver board from the connector.

Removing the Shunt Cards

- [] 1. Remove the four (4) #6-32 x 1/4" screws that secure the shunt card and bypass card using a #2 Phillips head screwdriver and unplug both cards from the connector. See Figure 2.9.

Figure 2.9 Removing the Shunt Cards

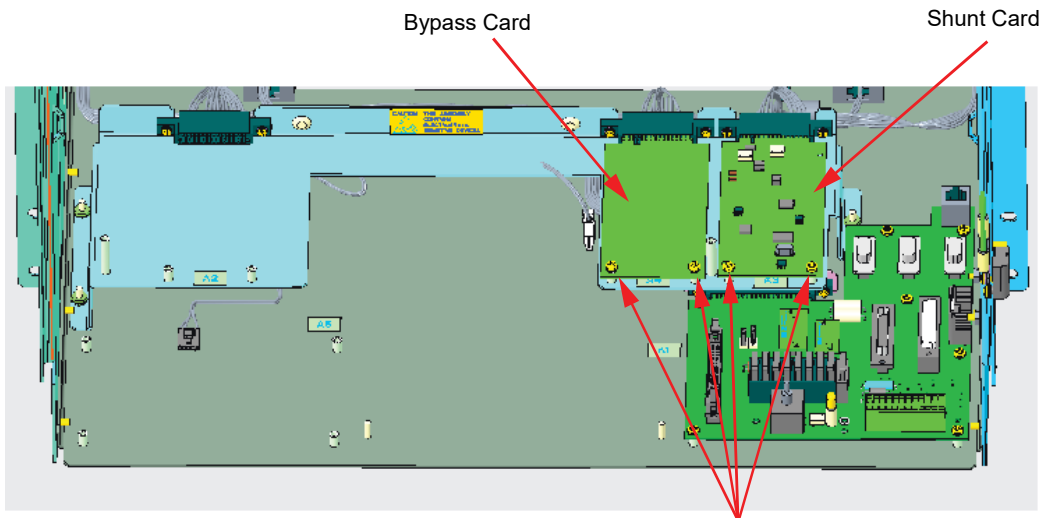

Remove these four (4) #6-32 x 1/4" screws that secure the shunt card and bypass card using a #2 Phillips head screwdriver and unplug both cards from the connector.

Installing the New LVD Driver Board (P/N 430021G1)

- [] 1. J8 is a system voltage selection connector. Set J8 to the correct voltage setting matching the primary/system voltage (-48V or +24V) of the system that is being retrofitted.

Figure 2.10 Setting the J8 to the Correct Voltage Setting

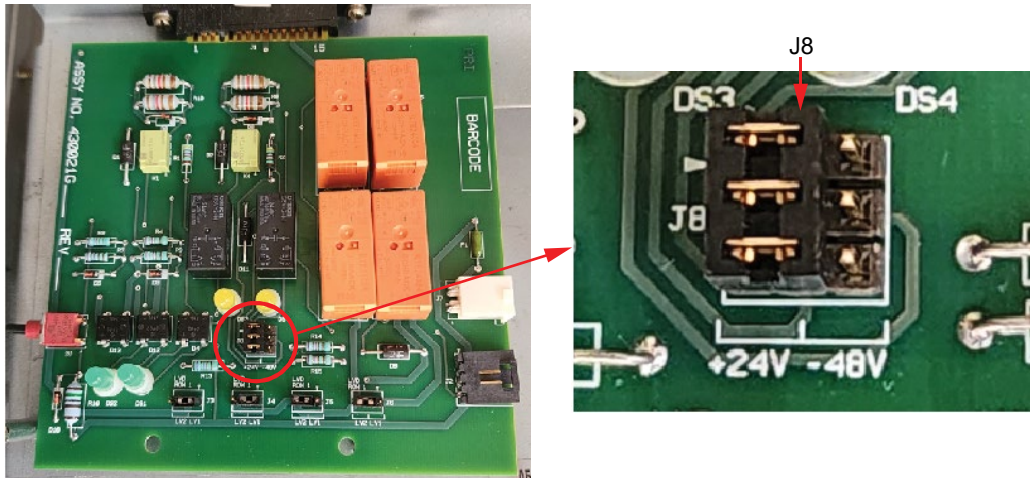

- [] 2. The SMDU has two (2) Low Voltage Disconnect (LVD) levels to control the operation of the LVDs. For each LVD in the bay, select by pulling out and reseating the jumper to the desired level you want the specific LVD to be controlled by. J3 is for LVD in Row 1 (bottom row), J4 is for LVD in Row 2, J5 is for LVD in Row 3, and J6 is for LVD in Row 4 as shown in Figure 2.11. If no LVD in that specific row, then the respective connector can stay as it is set.



WARNING! After the Bay LVD INHIBIT is reset, removing any of the connectors J3-J6 will result in the LVD opening.

Figure 2.11 Setting J3-J6 (LVD Row 1 through LVD Row 4) to the Correct Voltage Level for Each LVD

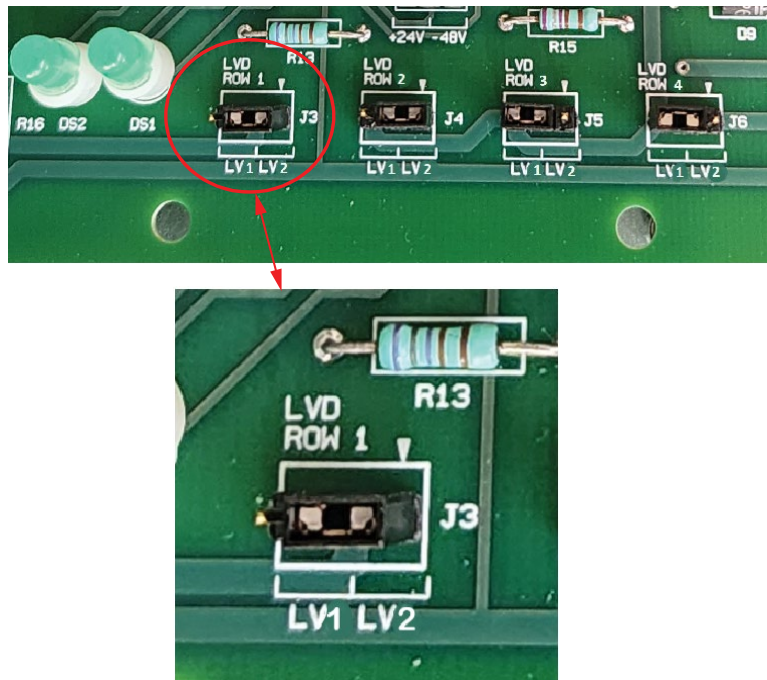

- [] 3. Plug the new LVD driver board to the connector and secure the LVD driver board with the provided two (2) #6-32 x 1/4" screws using a #2 Phillips head screwdriver. See Figure 2.12.

Figure 2.12 Installing the New LVD Driver Board

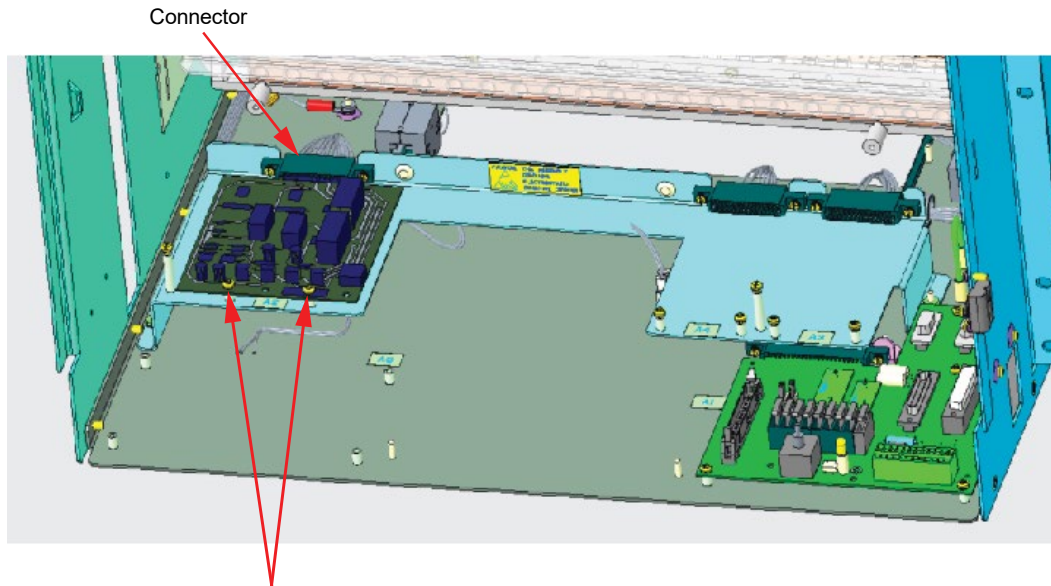

Plug the new LVD driver board to the connector and secure the LVD driver board with the provided two (2) #6-32 x 1/4" screws using a #2 Phillips head screwdriver.

- [] 4. Connect the connector J15 of the wire jumper to the connector J7 of the LVD driver board. See Figure 2.13.

Figure 2.13 Connecting the Wire Jumper

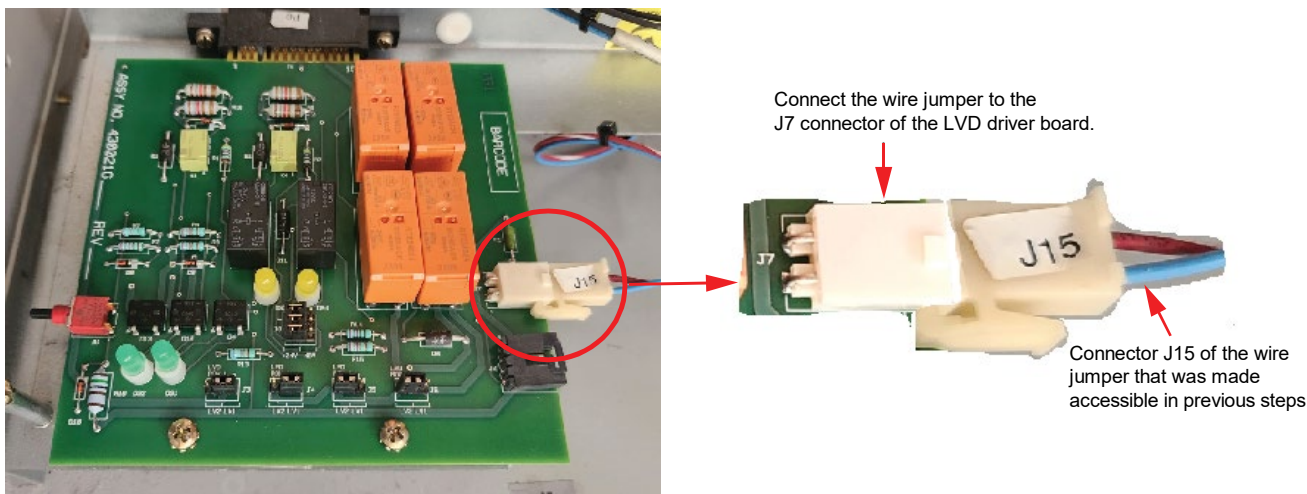

- [] 5. Check if the correct yellow LED comes on for the system voltage (+24V on the left and -48V on the right). If the correct yellow LED does not come on, stop the installation. Troubleshoot the fault for the wrong system type (check J8 is set correctly), power failure (check input voltage is present), or a faulty LVD driver board (replace the board).

Figure 2.14 Yellow LED for the System Voltage

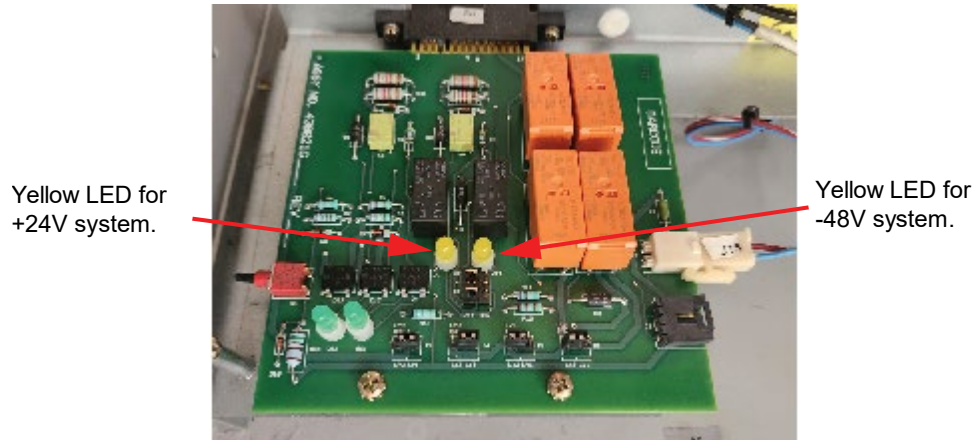

- [] 6. Check if the two (2) green LEDs come on as shown in Figure 2.15. Green LEDs represent power is being applied to the LVDs. If the two (2) green LEDs do not come on, press the Push button on the LVD driver board as shown in Figure 2.15. Ensure that the two (2) green LEDs come on. Even after pressing the Push button, if both green LEDs do not come on, STOP the installation. The LVD driver board is faulty and needs to be replaced.



NOTE! Two (2) green LED lights and one (1) yellow LED light should be ON continuously.

Figure 2.15 Green LEDs on the LVD Driver Board

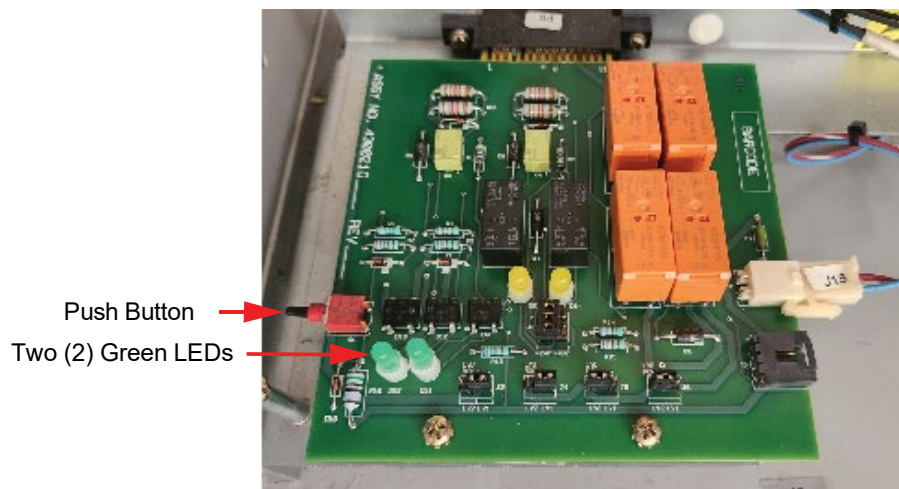

Installing the New INTERFACE Board (P/N 430001G1)

- [] 1. Remove all connections to the original INTERCONNECT card. The cables connected to J1 and J2 (if present) will not be re-used.

Figure 2.16 Removing the Connections

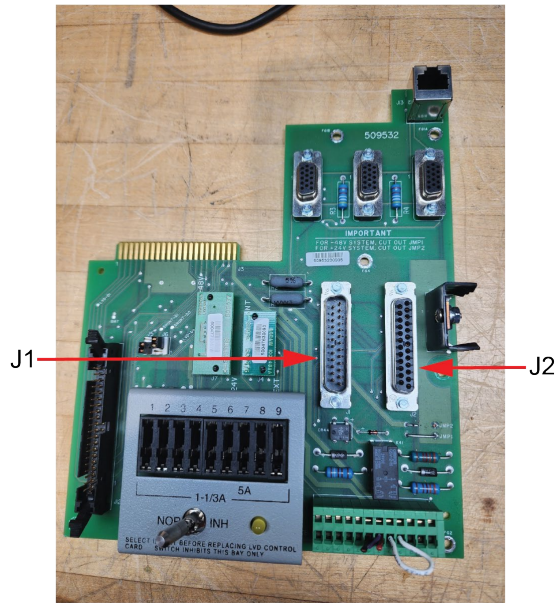

Old INTERCONNECT Card

- [] 2. Remove the old INTERCONNECT card by removing the six (6) #6-32 x 1/4" screws using a #2 Phillips head screwdriver. See Figure 2.17.

Figure 2.17 Removing the INTERCONNECT Card

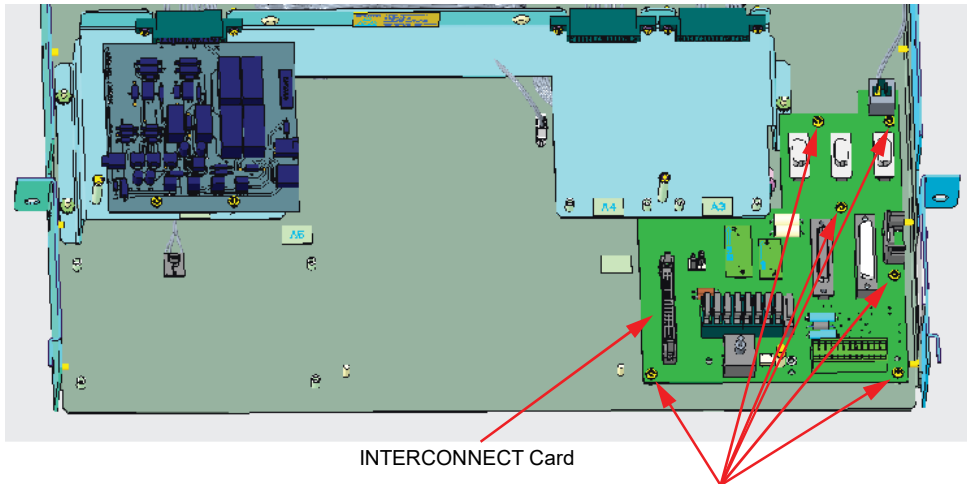

INTERCONNECT Card

Remove the old INTERCONNECT card by removing the six (6) #6-32 x 1/4" screws using a #2 Phillips head screwdriver.

- [] 3. Before installing the board, remove the three (3) fuses from the new INTERFACE board as shown in Figure 2.18. Save these three (3) fuses for later reuse. These fuses are for auxiliary power. Refer to the “INTERFACE board” section in the Retrofit Kit User Manual (UM60124057) for more information.

Figure 2.18 Removing the Fuses

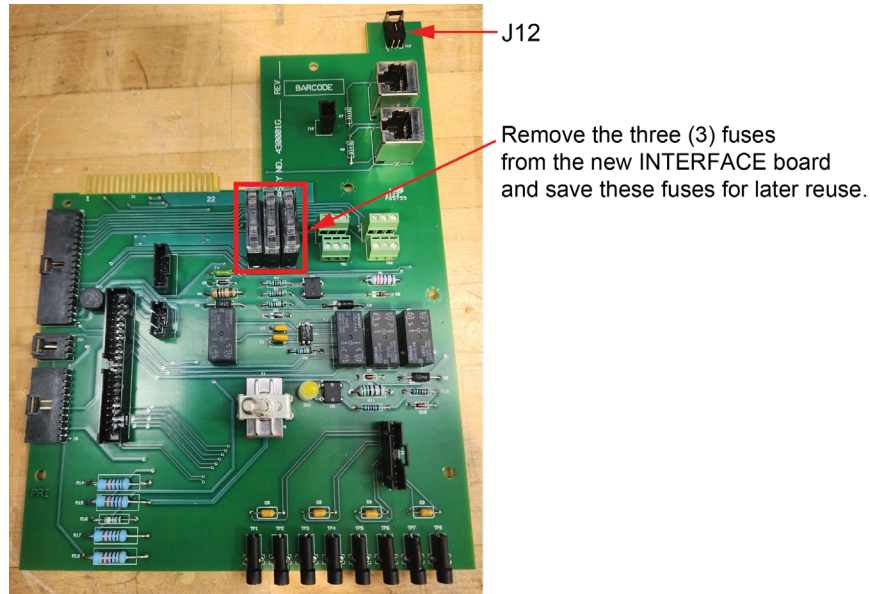

- [] 4. Connect one end of CAN jumper P/N 10060320 (provided in the jumper kit bag, P/N 10060005) to the J12 on the new INTERFACE board. See Figure 2.19. The connector on the other end will be secured to the last rectifier shelf connector in the later steps.

Figure 2.19 Connecting the CAN Jumper P/N 10060320

Connect one end of CAN jumper P/N 10060320 to the J12 on the new INTERFACE board.

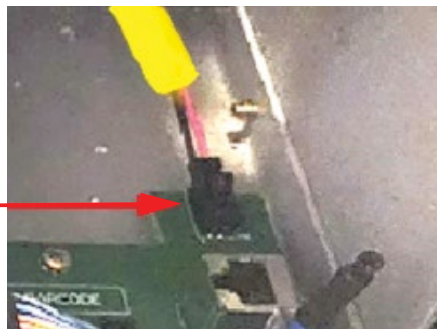

- [] 5. Plug in the new INTERFACE board in the location shown in Figure 2.20 aligning the six (6) mounting screw locations.



NOTE! The INTERFACE board should be plugged into a connector that is located under the sheet metal.

Figure 2.20 INTERFACE Board Plug In

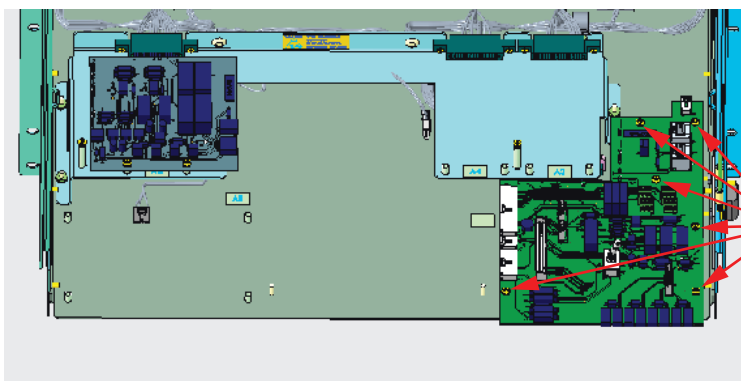

Plug in the new INTERFACE board in the location aligning the six (6) mounting screw locations.
Note: The INTERFACE board should be plugged into a connector that is located under the sheet metal.

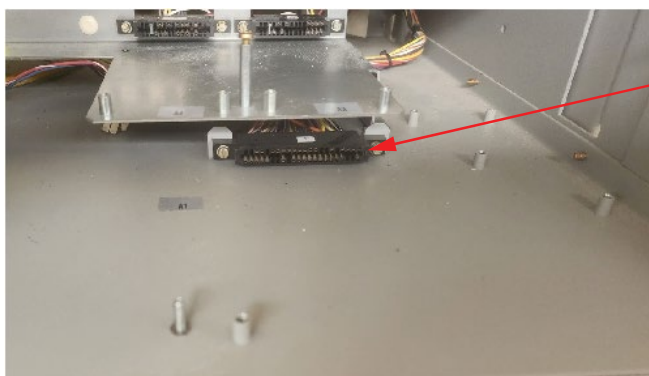

Connector Location

- [] 6. Secure the new INTERFACE board with the provided six (6) #6-32 x 1/4" screws using a #2 Phillips head screwdriver. See Figure 2.21.

Figure 2.21 Installing the INTERFACE Board

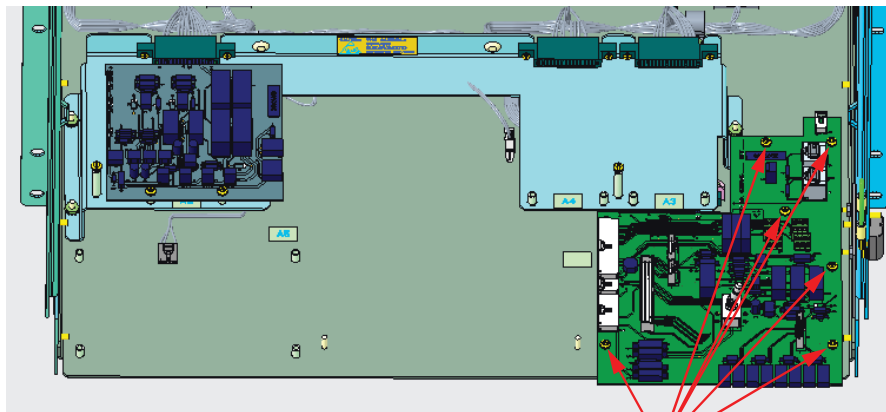

Secure the INTERFACE board with the provided six (6) #6-32 x 1/4" screws using a #2 Phillips head screwdriver.

- [] 7. Turn ON the inhibit switch. Make sure that the yellow LED on the INTERFACE board comes on.

Figure 2.22 Inhibit Switch Location

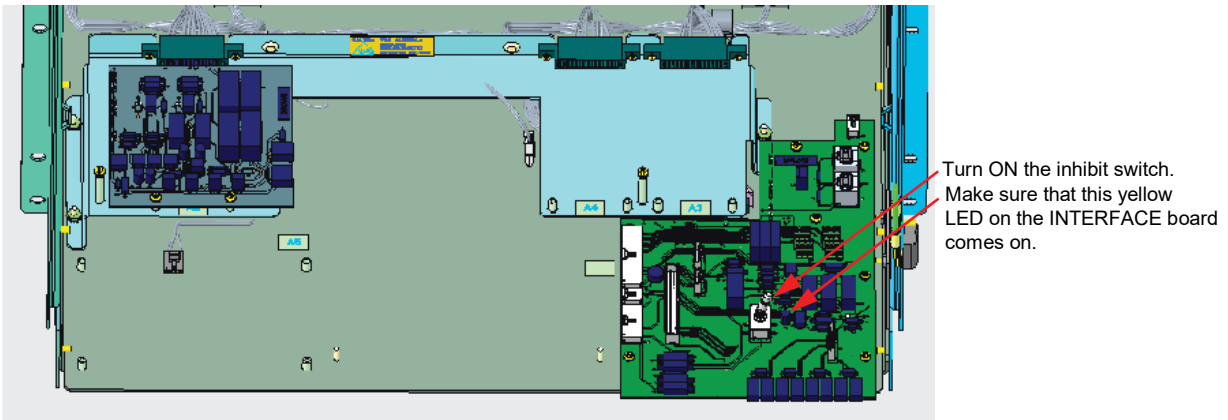

- [] 8. Route the other end of CAN jumper P/N 10060320 through the back of the system to the last rectifier shelf. Remove the terminator (if applicable) from the cable on the rectifier shelf and connect the connector to CAN jumper P/N 10060320. See Figure 2.23. Slack cable has to be ty wrapped and tucked away from sharp edges.



NOTE! For systems without any rectifiers, the P/N 10060320 jumper does not need to be routed to the back towards the bottom of the system. The connector on the open end of this jumper needs to remain accessible from the front for later installation steps (see Figure 2.34).

Figure 2.23 Routing of the CAN Jumper P/N 10060320 and Connection (cont'd on next page)

Note: For some systems, the CAN connector in the last rectifier shelf is accessible from the bottom of the shelf.

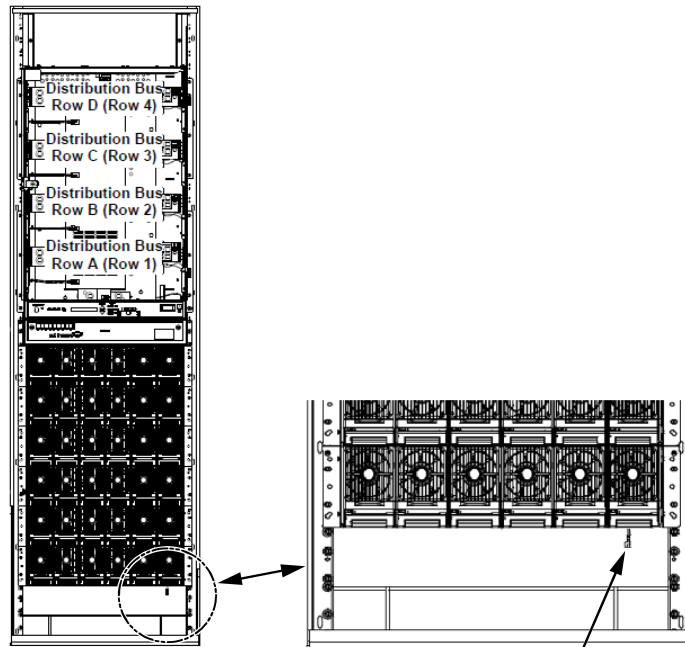

Route the other end of CAN jumper P/N 10060320 through the back of the system to the last rectifier shelf. Remove the terminator (if applicable) from the cable on the rectifier shelf and connect the connector to CAN jumper P/N 10060320.

Figure 2.23 Routing of the CAN Jumper P/N 10060320 and Connection (cont'd from previous page)

Note: For some systems, the CAN connector has to be accessed from the back of the system.

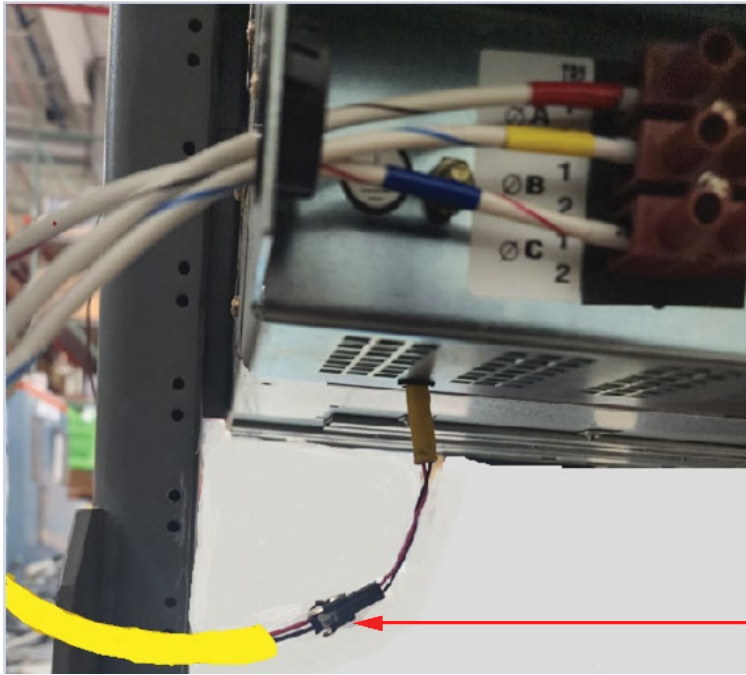

Route the other end of CAN jumper P/N 10060320 through the back of the system to the last rectifier shelf. Remove the terminator (if applicable) and connect the connector.

Installing the Optional SMDU+ Assembly (P/N 60121401)

- [] 1. Make sure that the DIP switch positions of the assembly are set as shown in the below Figure 2.24. Address is set on SW2 DIP 5, 6, and 7. Other positions to be OFF. Refer to Table 2.5 for SW2 settings.
- [] 2. SW1 is set to Address #2 (for first supplemental bay) but can be any desired address from 1 to 8 as long as it is a unique address.
- [] 3. When setting Address, you must make sure the Address is not used in another bay.

Figure 2.24 DIP Switches Positions of the SMDU+ Board (P/N SMDU2)

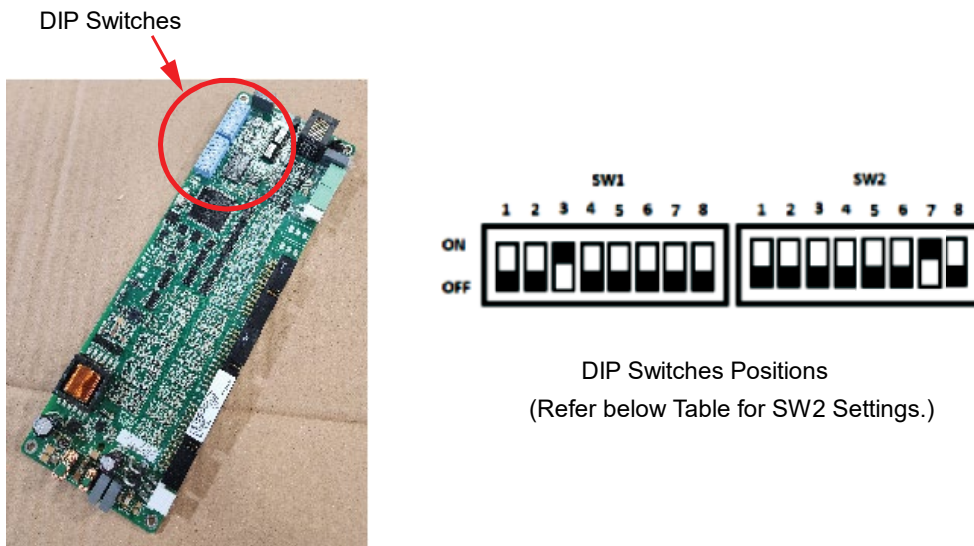

DIP Switches Positions
(Refer below Table for SW2 Settings.)

Table 2.5 Switch Settings

DIP Switch SW2			
Communications Address			Descriptions of Status
5	6	7	
OFF	OFF	OFF	Address 1#
OFF	OFF	ON	Address 2#
OFF	ON	OFF	Address 3#
OFF	ON	ON	Address 4#
ON	OFF	OFF	Address 5#
ON	OFF	ON	Address 6#
ON	ON	OFF	Address 7#
ON	ON	ON	Address 8#

- [] 4. Place the insulating sheet over the two standoffs of the mounting plate. See Figure 2.25.

Figure 2.25 Placing the Insulation Sheet to the Mounting Plate (P/N 60121399)

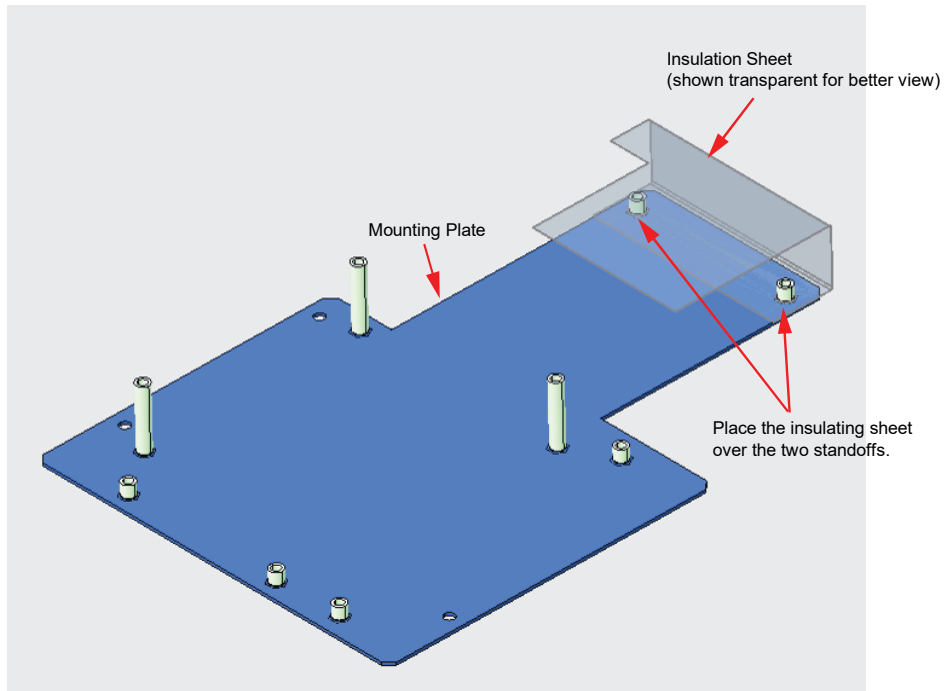

- [] 5. Install the SMDU+ assembly to the mounting plate with the provided four (4) #6-32 x 1/4" screws using a #2 Phillips head screwdriver. See Figure 2.26.

Figure 2.26 Installing the SMDU+ Board (P/N SMDU2)

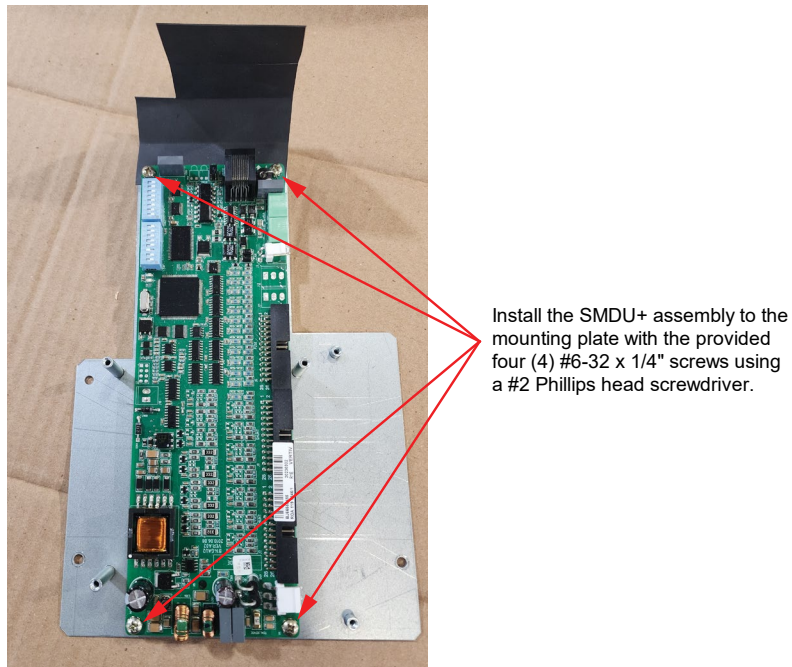

- [] 6. Plug in the two (2) ribbon cables of the shunt interface board (P/N 541277) to the corresponding connectors in the SMDU+ board (P/N SMDU2) as shown in Figure 2.27.

Figure 2.27 Connecting the Ribbon Cables of the Shunt Interface Board (P/N 541277) to the SMDU+ Board (P/N SMDU2)

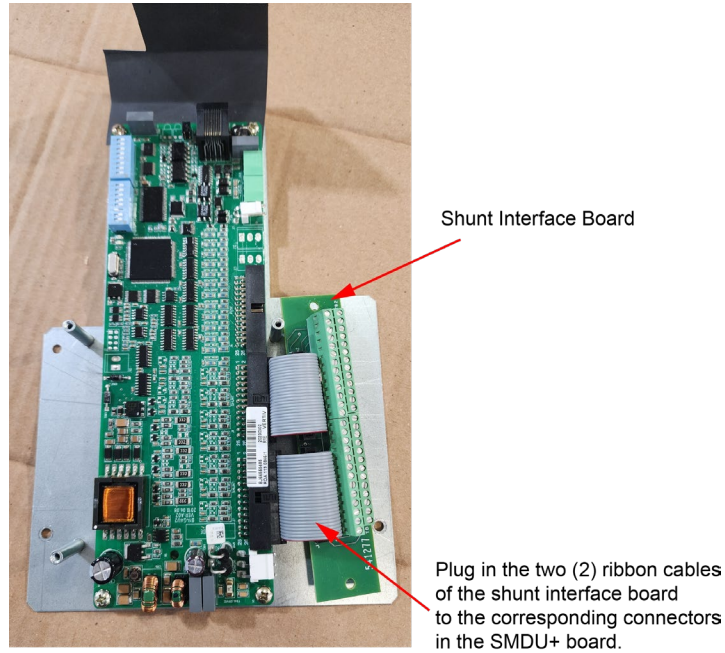

- [] 7. Install the shunt interface board (P/N 541277) to the mounting plate with the provided two (2) #6-32 x 1/4" screws using a #2 Phillips head screwdriver. See Figure 2.28.

Figure 2.28 Installing the Shunt Interface Board

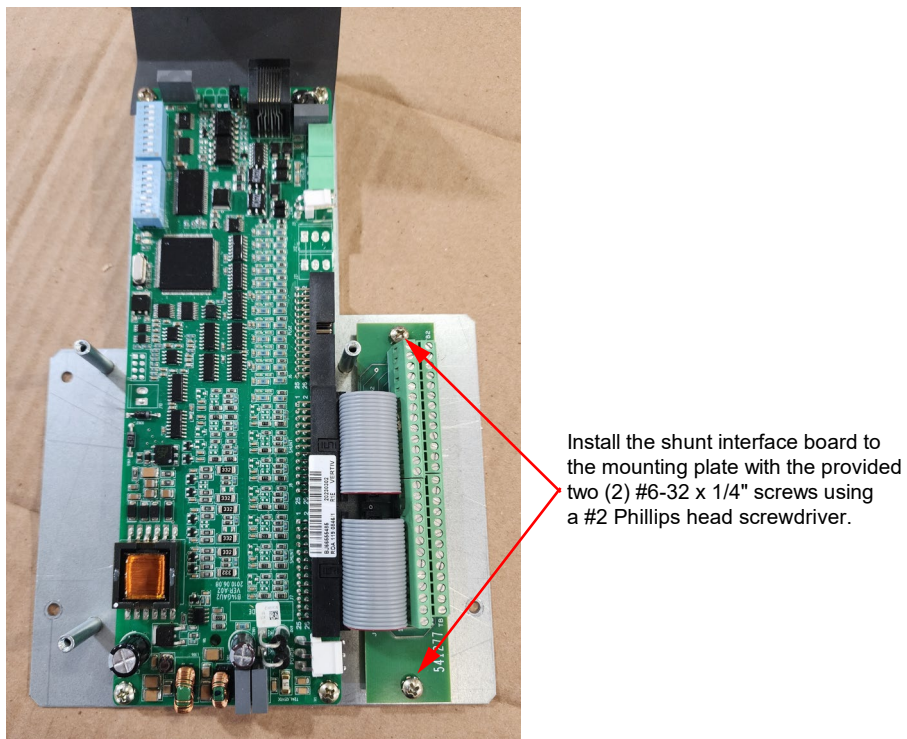

- [] 8. Connect the harness P/N 10060323 (connector labelled SMDU+J3) to the SMDU+ (P/N SMDU2) CAN connector J3 in the PC board. See Figure 2.29.

Figure 2.29 Connecting SMDU+ CAN Connector

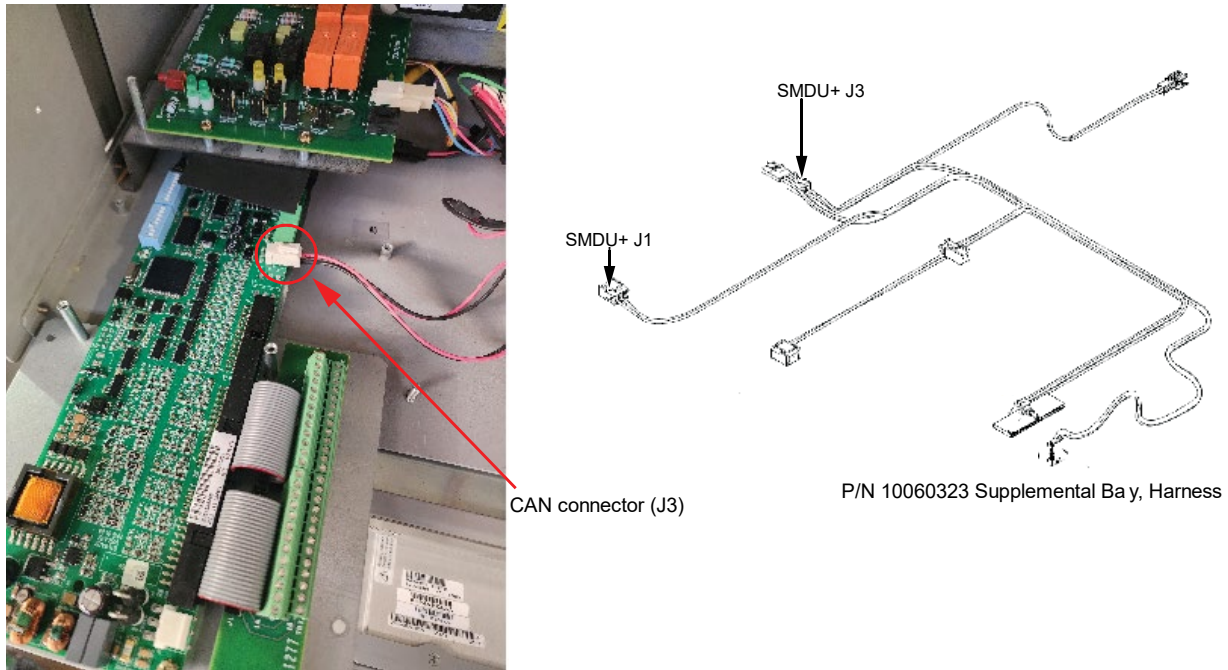

- [] 9. Secure the mounting plate to the base of the system with the provided three (3) #6-32 x 1/4" screws using a #2 Phillips head screwdriver. See Figure 2.30.

Figure 2.30 Installing the Assembly

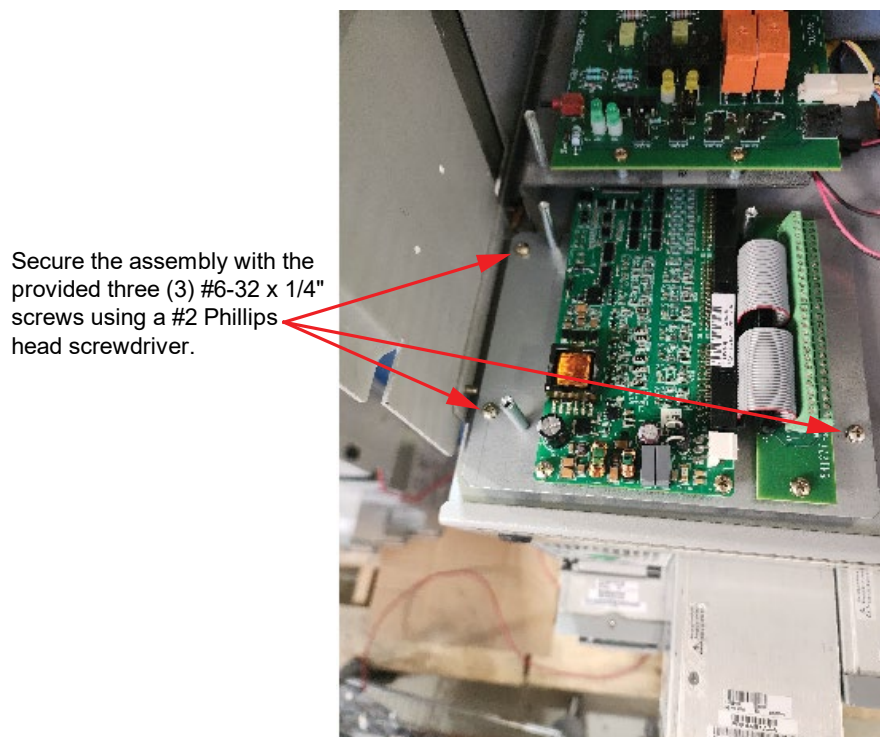

- [] 10. Connect the harness P/N 10060323 (connector labelled SMDU+J1) to the SMDU+ (P/N SMDU2) power connector J1 in the PC board.

Figure 2.31 Connecting SMDU+ Power Connector

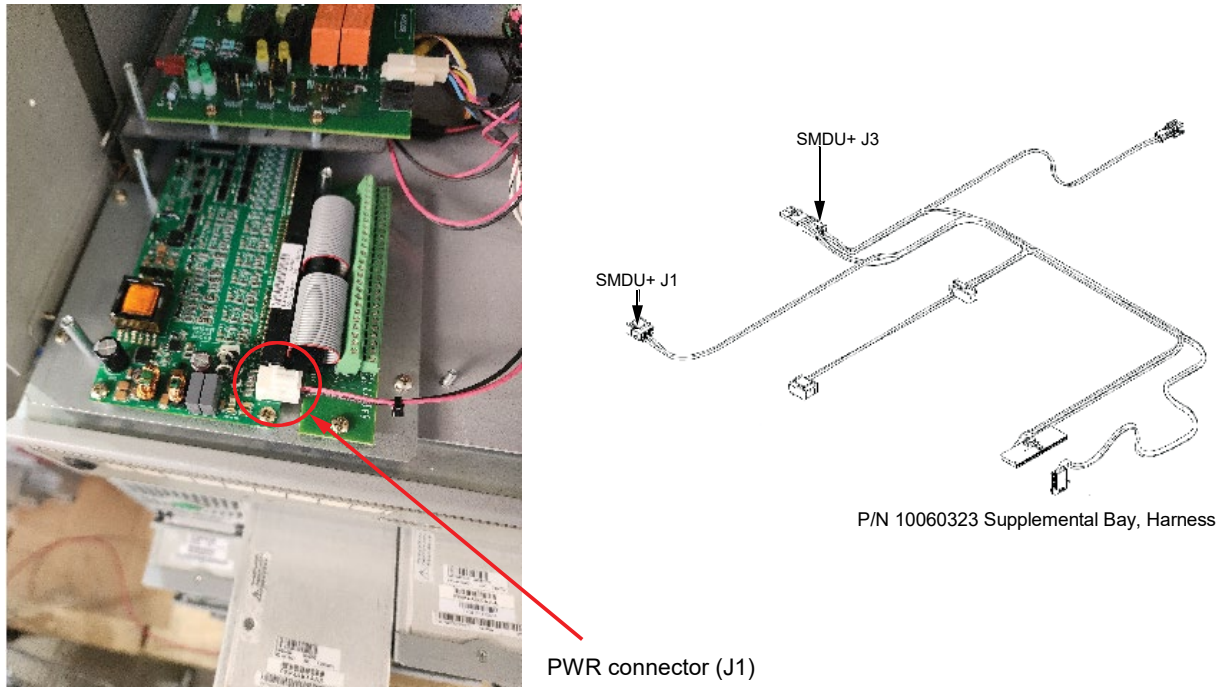

If Not Installing the Optional SMDU+ Assembly (P/N 60121401)

Perform the below steps if you are not installing the optional SMDU+ assembly.

- [] 1. Sleeve the connector (connector labelled SMDU+J3) of the P/N 10060323 harness with the black shrink sleeve (P/N 73-78-440) and ty wrap provided in the jumper kit package (do not use the heat gun).
- [] 2. Install only the mounting plate to the base of the system with the provided three (3) #6-32 x 1/4" screws using a #2 Phillips head screwdriver.
- [] 3. Sleeve the connector (connector labelled SMDU+J1) of P/N 10060323 harness with the black shrink sleeve (P/N 73-78-440) and ty wrap provided in the jumper kit package (do not use the heat gun).

Installing the SHUNT I/O Board (P/N 430011G1)

1. To install the SHUNT I/O board, perform the procedure in Figure 2.32.

Figure 2.32 Installing the SHUNT I/O Board

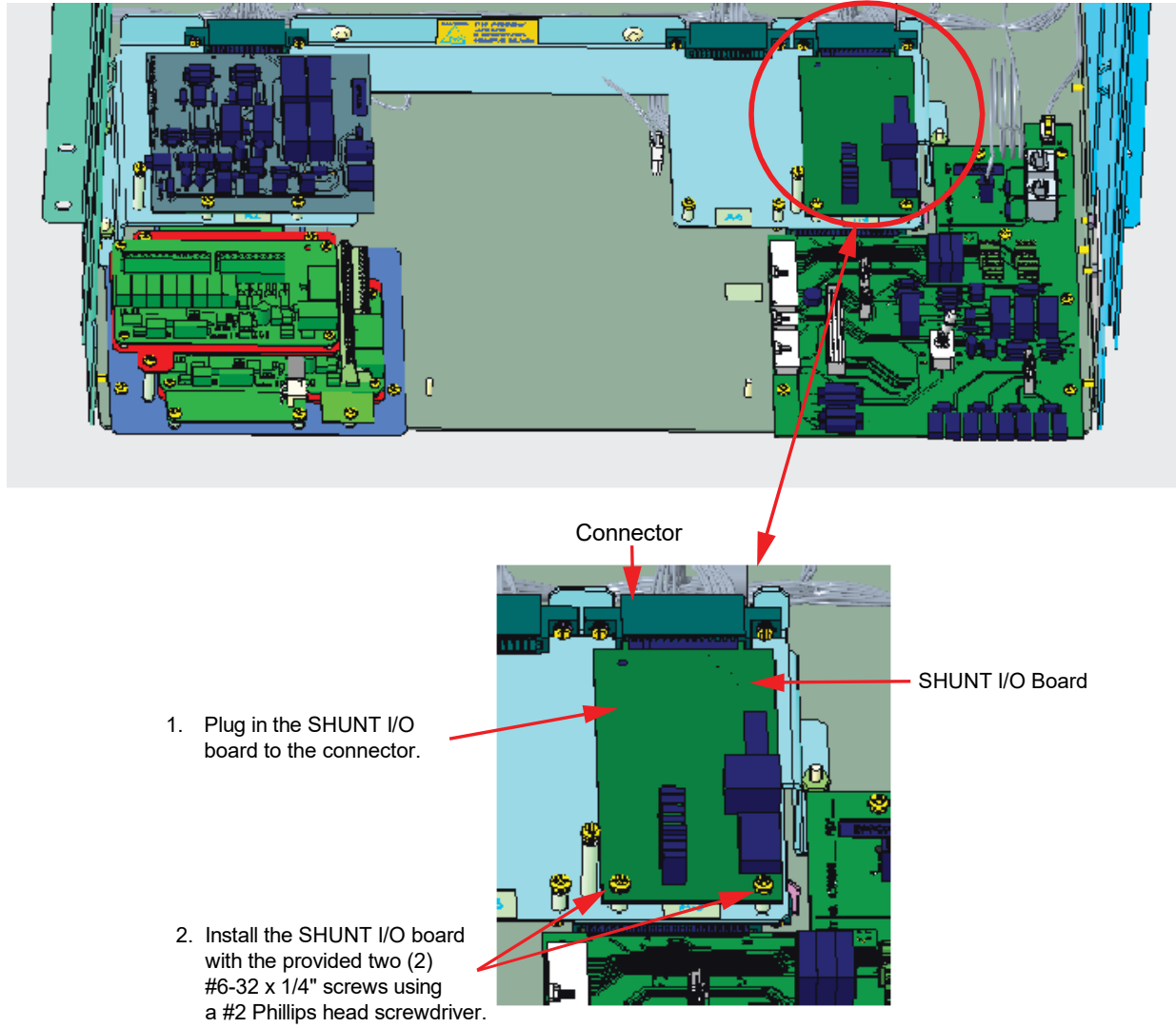

Installing the SMDU Assembly (P/N 60122807)

- [] 1. Make sure that the DIP switch positions of the assembly are set as shown in the below Figure 2.33. Address is set on S1 DIP 1, 2, and 3. Refer to Table 2.6 for S1 settings.

Figure 2.33 DIP Switches Positions



DIP Switches Positions

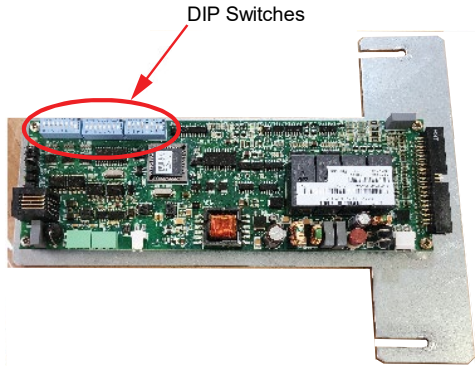
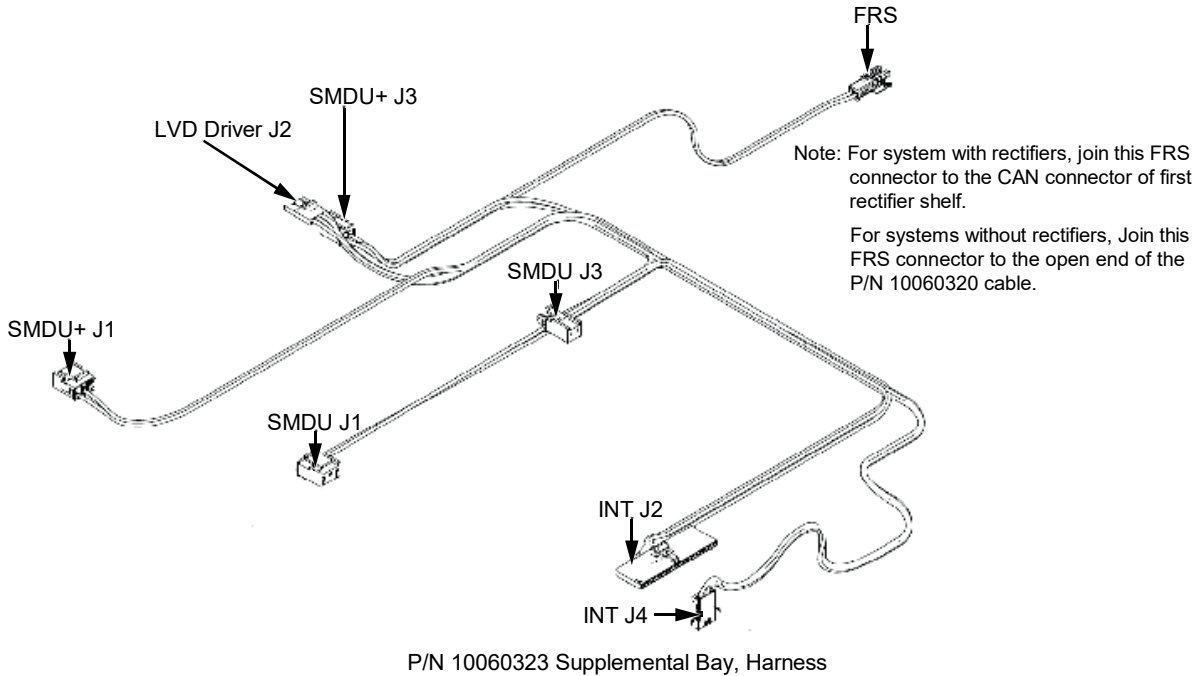

Table 2.6 Switch Settings

DIP Switch S1			
Communications Address			Descriptions of Status
1	2	3	
ON	ON	OFF	Address 6# (1 st NetSure™ 701 supplemental bay)
ON	ON	ON	Address 7# (2 nd NetSure™ 701 supplemental Bay)
OFF	OFF	OFF	Address 8# (3 rd NetSure™ 701 supplemental bay)

- [] 2. Connect the connectors of the P/N 10060323 supplemental bay, harness to the LVD driver board, SMDU assembly and INTERFACE board. See Figure 2.34.

Figure 2.34 Connecting Connectors



- 1. Connect the LVD driver J2 connector to the J2 on the LVD driver board.

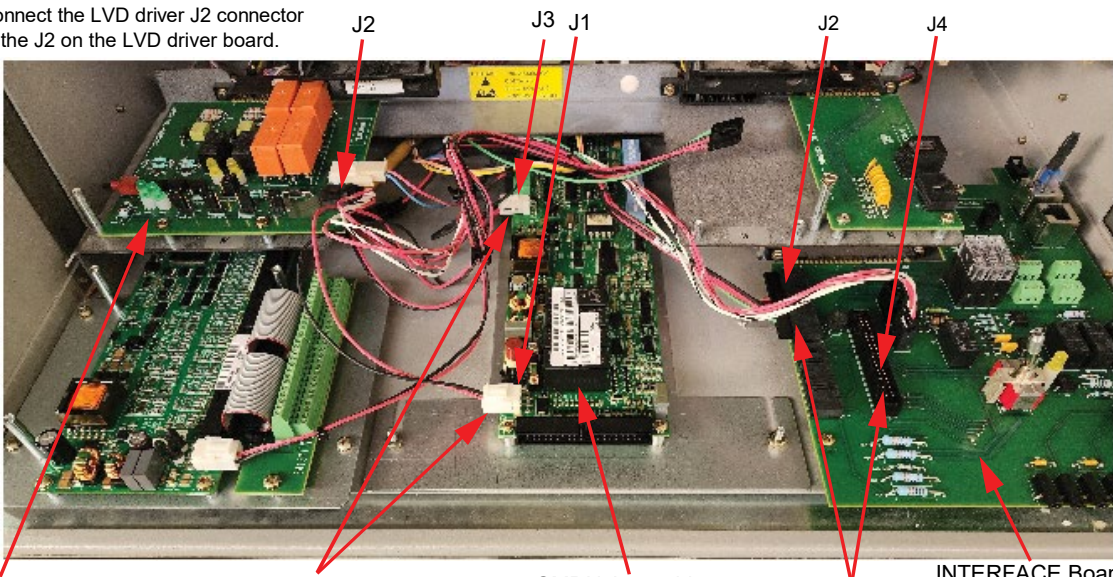

LVD Driver Board

- 2. Connect the SMDU J1 connector to the J1 on the SMDU assembly.
- 3. Connect the SMDU J3 connector to the J3 on the SMDU assembly.

SMDU Assembly

- 4. Connect the INT J2 connector to the J2 on the INTERFACE board.
- 5. Connect the INT J4 connector to the J4 on the INTERFACE board.

INTERFACE Board

- [] 3. Slide in the SMDU assembly (P/N 60122807) between the two studs and secure with the provided two (2) #6-32 keps nuts using a 1/2-inch nut driver tool. See Figure 2.35.

Figure 2.35 Installing the SMDU Assembly

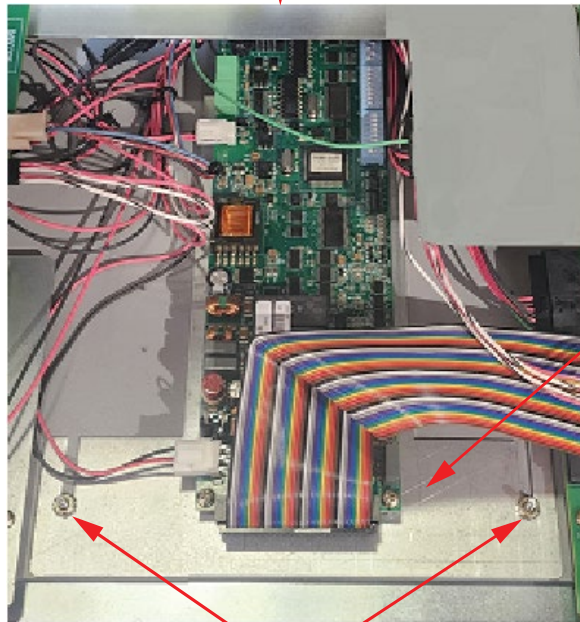
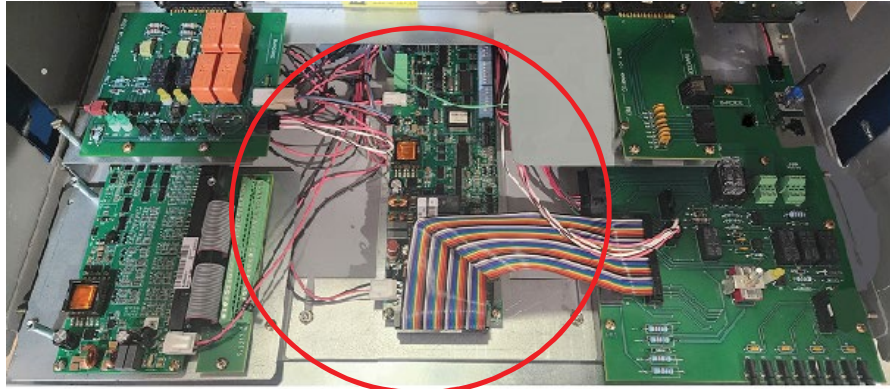

SMDU
Assembly

Slide in the SMDU assembly between the two studs and secure with the provided two (2) #6-32 keps nuts using a 1/2-inch nut driver tool.

- [] 4. Plug in one end of ribbon cable P/N 10062782 to the SMDU and the other end to J6 on the INTERFACE board. See Figure 2.36.

Figure 2.36 Connecting the Ribbon Cable P/N 10062782

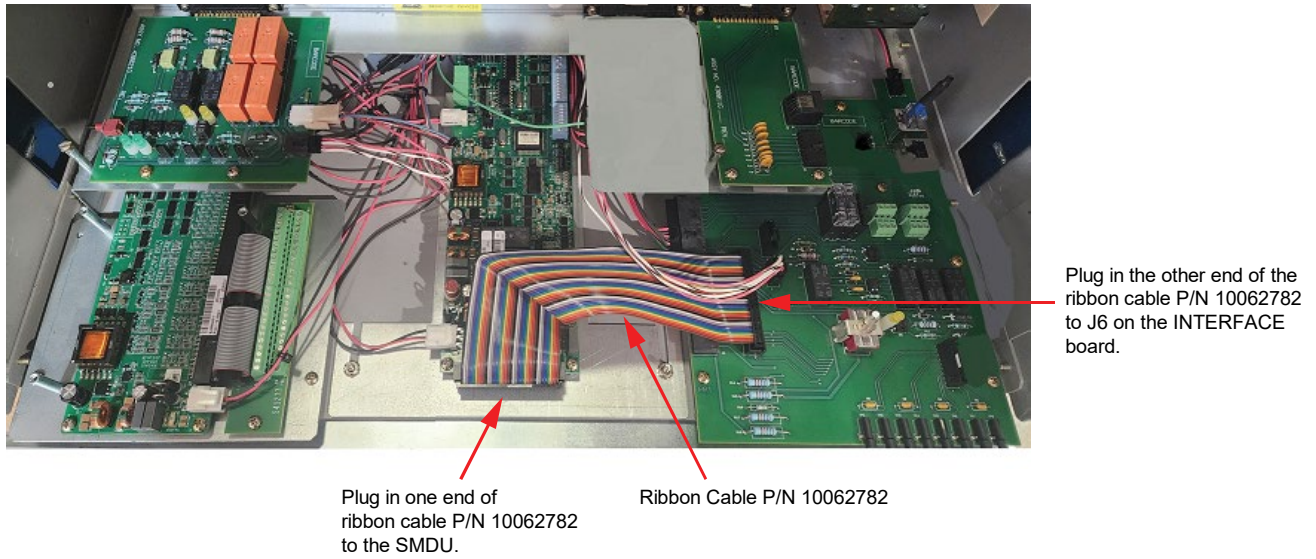

Installing the CAN INTERFACE Board (P/N 430161G1)

1. To install the CAN INTERFACE board, perform the procedure in Figure 2.37.

Figure 2.37 Installing CAN INTERFACE Board

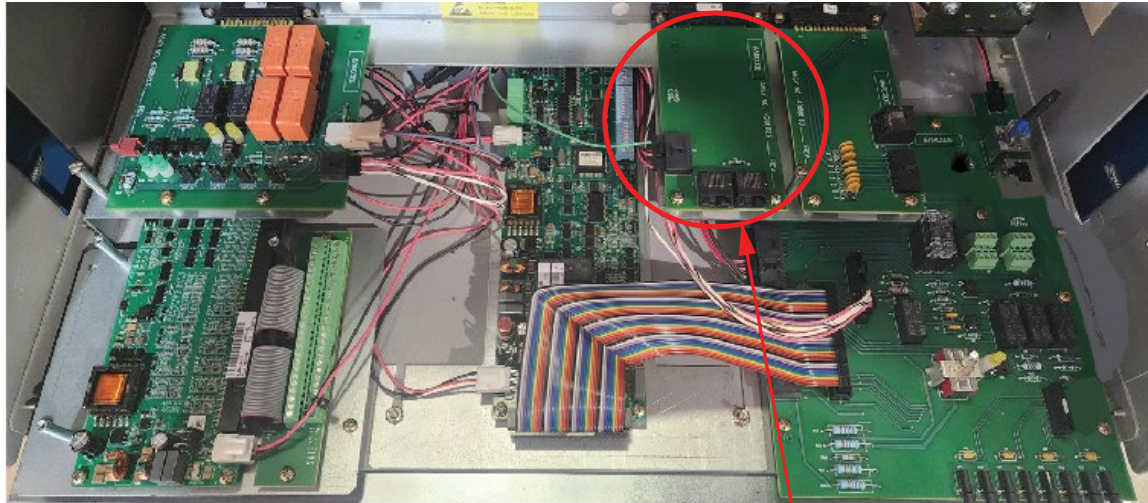

Connector

CAN INTERFACE Board

1. Plug in the CAN INTERFACE board to the connector.
2. Install the CAN INTERFACE board with the provided two (2) #6-32 x 1/4" screws using a #2 Phillips head screwdriver.
3. Connect the connector to J3 Connector.

ASSEMBLY NO. 430161G1
PART NO. 430161G1
REV. 1.0
BARCODE
ASSEMBLY NO. 430161G1

Installing the Front Plate (P/N 60122808)



NOTE! While installing the front plate, make sure that the insulation piece is adhered to the inside of the bottom flange.

1. Loosen the two (2) #6-32 keps nuts that secure the SMDU assembly using a 1/2-inch nut driver tool and slide the front plate between the two studs on top of the SMDU mounting plate. Tighten the keps nuts using a same 1/2-inch nut driver tool. See Figure 2.38.

Figure 2.38 Installing the Front Plate

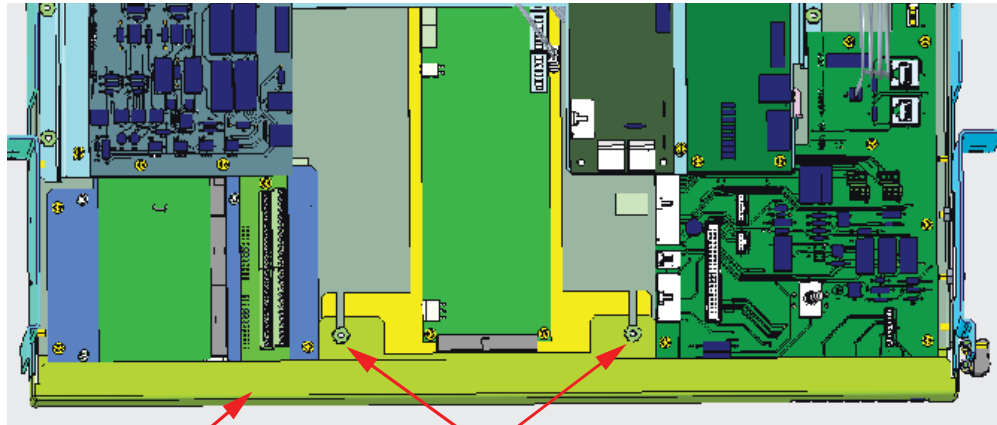

Front Plate Assembly

Loosen the two (2) #6-32 keps nuts that secure the SMDU assembly using a 1/2-inch nut driver tool and slide the front plate between the two studs on top of the SMDU mounting plate. Tighten the keps nuts using the same 1/2-inch nut driver tool.

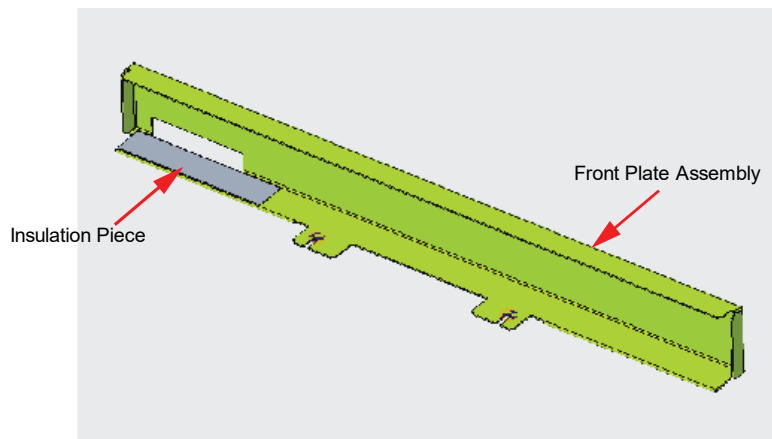

Insulation Piece

Front Plate Assembly

Installing the Fuses on the INTERFACE Board

1. Install the fuses (that were removed from the new INTERFACE board in Figure 2.18) on the INTERFACE board. See Figure 2.39. Fuses are for auxiliary power. Refer to the “INTERFACE board” section in the Retrofit Kit User Manual (UM60124057) for more information.

Figure 2.39 Installing the Fuses

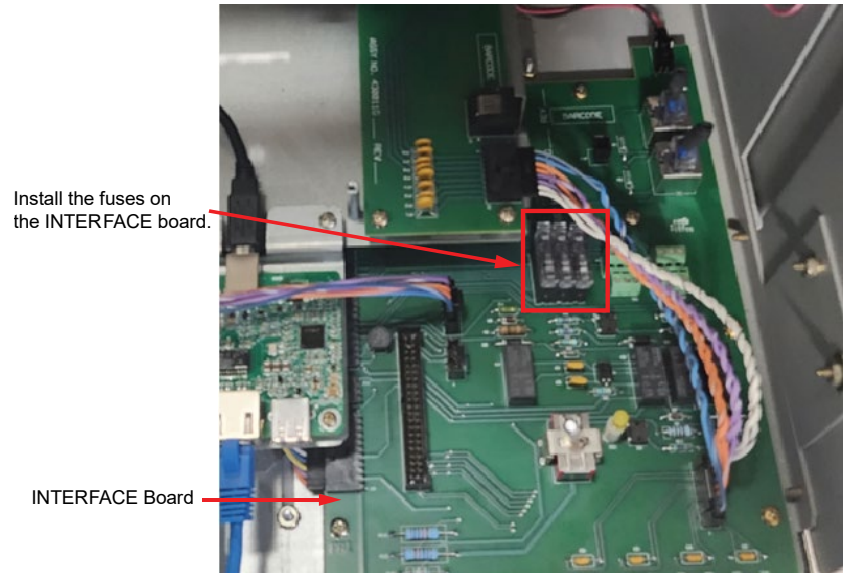

SHUNT I/O Board, CAN INTERFACE Board and INTERFACE Board Connections

- [] 1. Connect one end of the jumper P/N 10060318 (provided in the jumper kit labelled P/N 10060005) to the J2 connector on the SHUNT I/O board and the other end to J3 on the INTERFACE board. See Figure 2.40.

Figure 2.40 Connecting jumper P/N 10060318

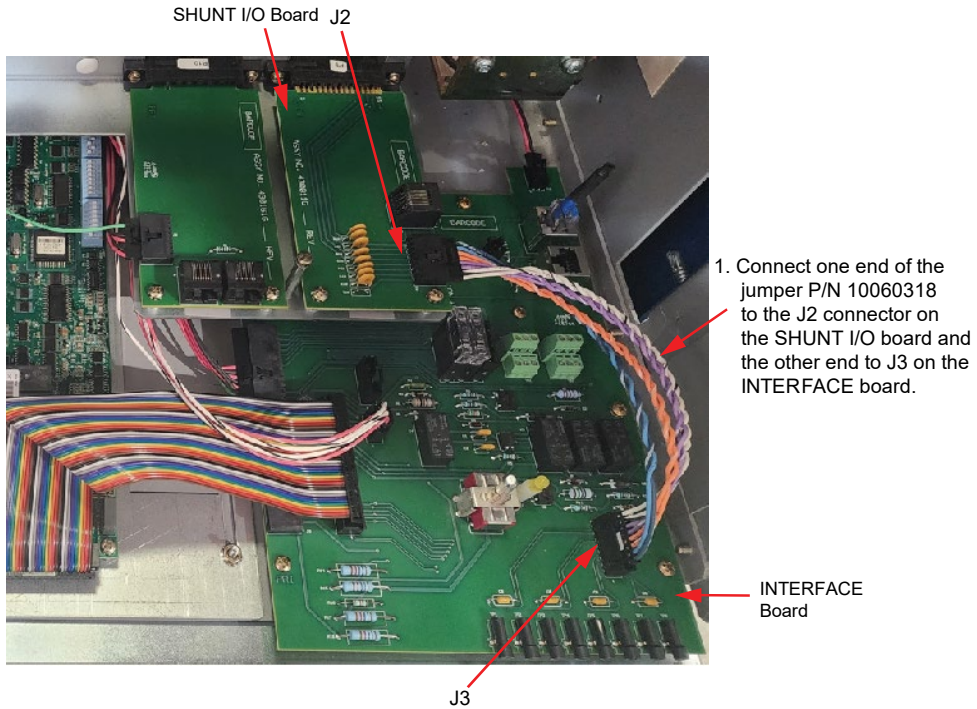

- [] 2. Refer to the “Main Bay to Supplemental Bay Communications Cable Connections” section in the Retrofit Kit User Manual (UM60124057) for the connection of jumper P/N 528520 to the CAN INTERFACE board and to the INTERFACE board.

Figure 2.41 Connecting Jumper P/N 528520

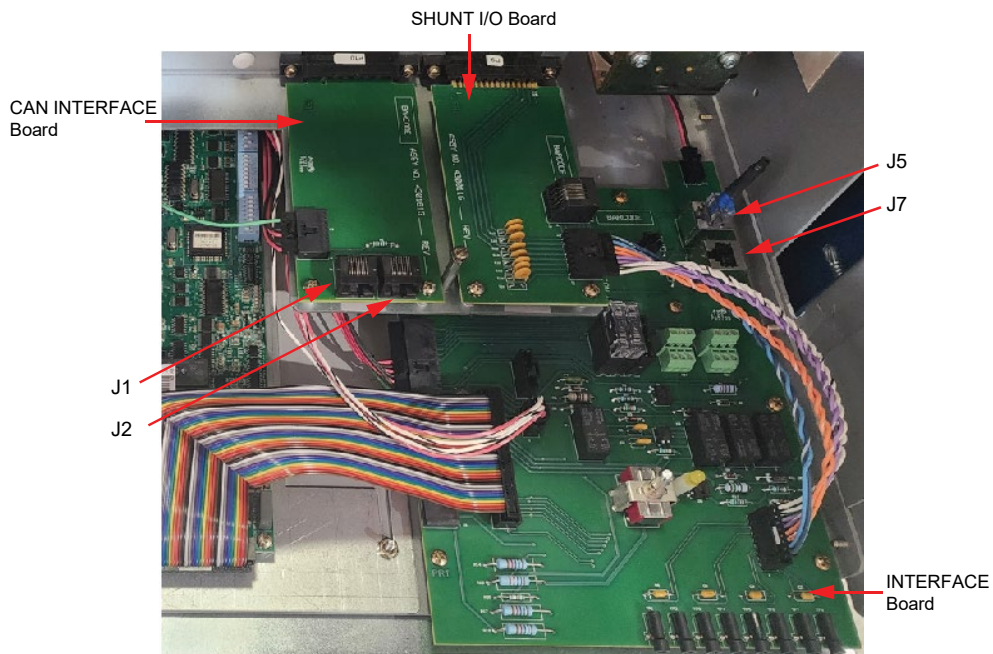

- [] 3. Select the appropriate configuration in the “Bay-to-Bay Communications Cable Connections” sections in the Retrofit Kit User Manual (UM60124-057) based on the number of supplemental bays.

Adhering Labels

- [] 1. Adhere labels provided in the retrofit kit, in the specific locations. See Figure 2.42 and Figure 2.43. Use a permanent marker to write the Installation date in the appropriate field of the labels.

Figure 2.42 Label

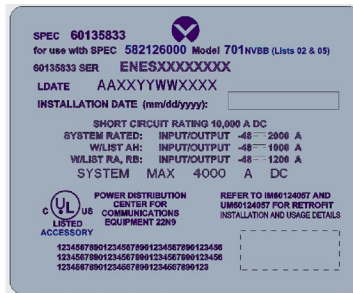
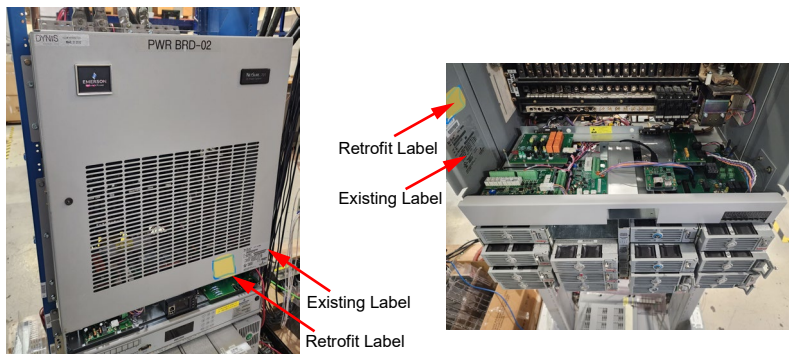
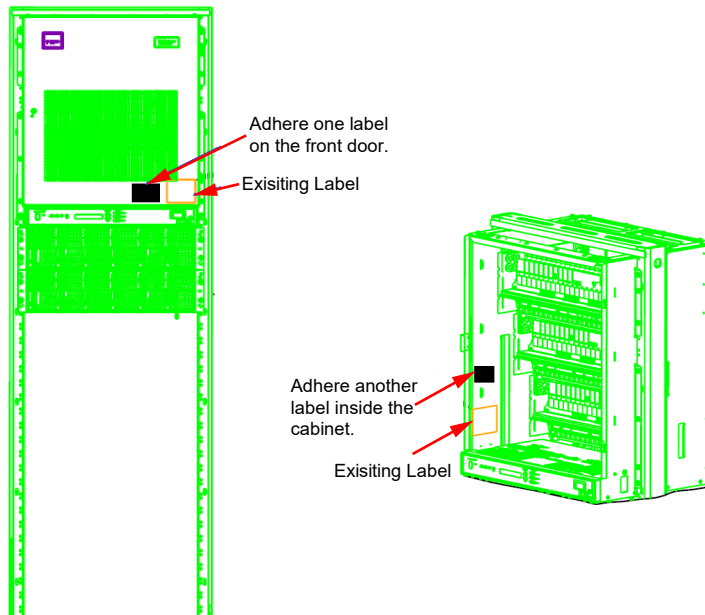

Figure 2.43 Location for the Labels



Final Procedure

- [] 1. From the kit, take out the lexan panel (P/N 60128403) and align its keyholes with the loosened screws (see Figure 2.4). Slide the lexan panel inwards (to the end of the keyholes) and tighten the two (2) #6-32 x 1/2" Phillips head screws using a #2 Phillips head screwdriver. See Figure 2.44.

Figure 2.44 Installing the Lexan Panel

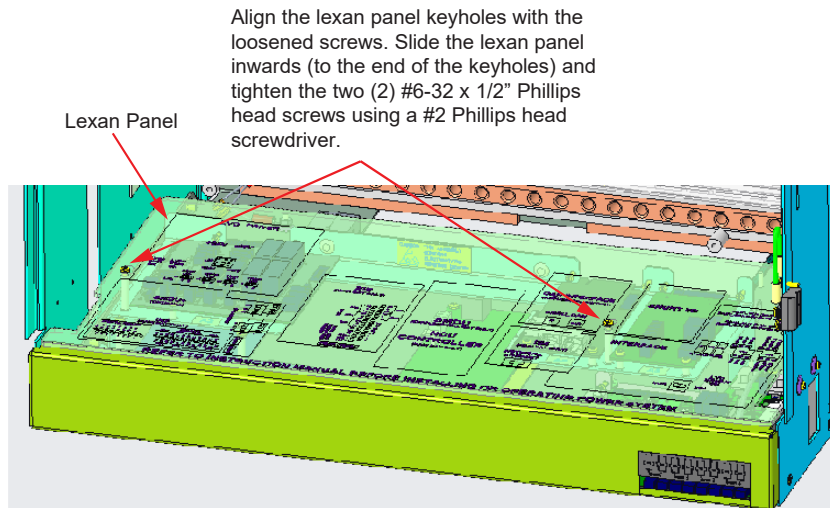

- [] 2. Close the front door. The door latch automatically gets engaged, and it secures the door.
- [] 3. Proceed to section "Installing the NCU Controller" on page 75 to install the controller in the main bay.
- [] 4. Refer to the Retrofit Kit User Manual (UM60124057) for the controller programming information.

3 Installing the NCU Controller (1M830BNA)



DANGER! Adhere to the “Important Safety Instructions” presented at the front of this document.



DANGER! Respecter les « Instructions de sécurité importantes » présentées au début du présent document.



ALERT! CONTROLLER HANDLING. Installation or removal of the controller requires careful handling. To avoid possibility of controller damage from static discharge, a static wrist strap grounded through a one megohm resistor should always be worn when handling the controller. ESD-protective packaging material must also be used when carrying/shipping the controller.



ALERTE! GESTION DES CONTRÔLEURS. L'installation ou le retrait du contrôleur nécessite une manipulation prudente. Pour éviter la possibilité de dommages au contrôleur dus à une décharge statique, une sangle de poignet statique mise à la terre à travers une résistance megohm doit toujours être portée lors de la manipulation du contrôleur. Des matériaux d'emballage de protection contre l'ESD doivent également être utilisés lors du transport ou de l'expédition du contrôleur.



WARNING! To prevent damage to the latching mechanism, ensure the handle is in the open position when installing or removing a controller. NEVER hold the handle in the closed position when installing a controller into a shelf.



ATTENTION! Pour éviter d'endommager le mécanisme de verrouillage, assurez-vous que la poignée est en position ouverte lors de l'installation ou du retrait d'un contrôleur. Ne tenez JAMAIS la poignée en position fermée lors de l'installation d'un contrôleur dans une étagère.

Procedure

- [] 1. Connect an approved grounding strap to your wrist. Attach the other end to a suitable ground.
- [] 2. Place the controller in the slot through the front panel dedicated for controller mounting without sliding it completely as shown in Figure 3.1.
- [] 3. Loosen the captive fastener securing the latch mechanism to the front of the controller. Pull the latch mechanism away from the controller (this will retract the latch mechanism located on the bottom of the controller).
- [] 4. Slide the controller completely into its mounting position.
- [] 5. Push the latch mechanism into the front panel of the controller, and secure by tightening the captive fastener. This locks the controller securely to the shelf.
- [] 6. Refer to the Retrofit Kit User Manual (UM60124-057) provided with the kit for the controller programming information.

Figure 3.1 Installing the Controller (1M830BNA)

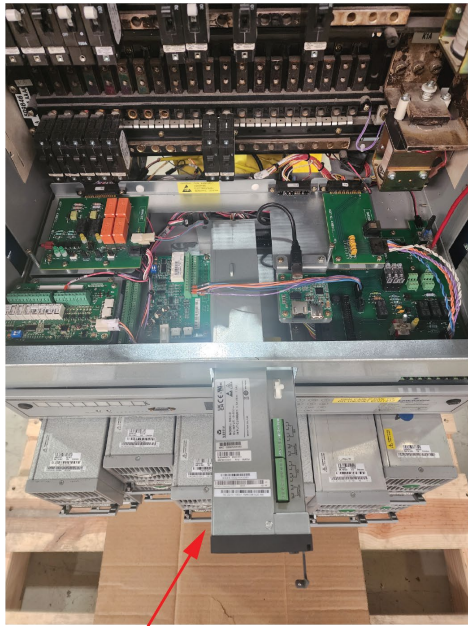
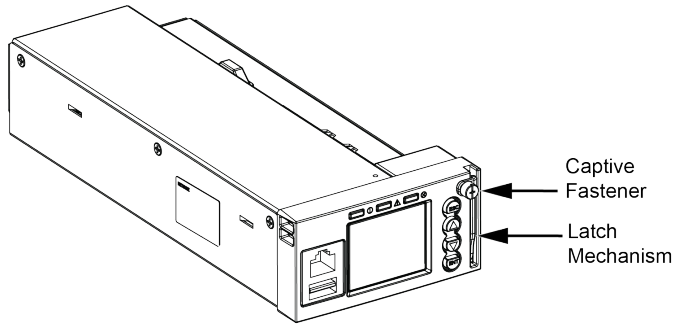

NCU Controller

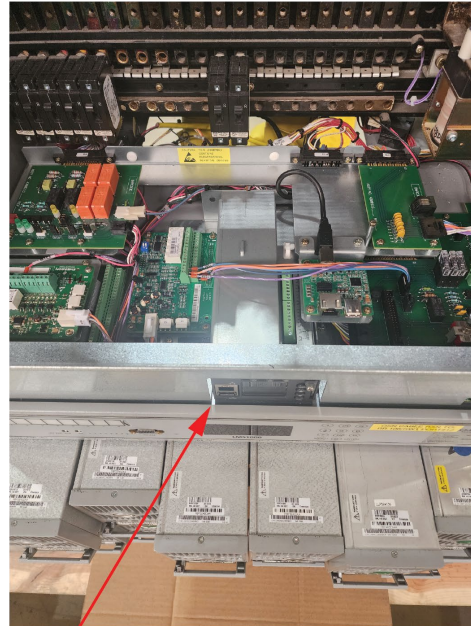

NCU Controller
Installed View

Connect with Vertiv on Social Media



<https://www.facebook.com/vertiv/>



<https://www.instagram.com/vertiv/>



<https://www.linkedin.com/company/vertiv/>



<https://www.x.com/vertiv/>



Vertiv.com | Vertiv Headquarters, 505 N Cleveland Ave, Westerville, OH 43082, USA

© 2024 Vertiv Group Corp. All rights reserved. Vertiv™ and the Vertiv logo are trademarks or registered trademarks of Vertiv Group Corp. All other names and logos referred to are trade names, trademarks or registered trademarks of their respective owners. While every precaution has been taken to ensure accuracy and completeness here, Vertiv Group Corp. assumes no responsibility, and disclaims all liability, for damages resulting from use of this information or for any errors or omissions.