



Liebert® XDU450

Coolant Distribution Unit

Application and Planning Guide

The information contained in this document is subject to change without notice and may not be suitable for all applications. While every precaution has been taken to ensure the accuracy and completeness of this document, Vertiv assumes no responsibility and disclaims all liability for damages resulting from use of this information or for any errors or omissions.

Vertiv recommends installing a monitored fluid detection system that is wired to activate the automatic closure of field-installed coolant fluid supply and return shut off valves, where applicable, to reduce the amount of coolant fluid leakage and consequential equipment and building damage. Refer to local regulations and building codes relating to the application, installation, and operation of this product. The consulting engineer, installer, and/or end user is responsible for compliance with all applicable laws and regulations relating to the application, installation, and operation of this product.

The products covered by this instruction manual are manufactured and/or sold by Vertiv. This document is the property of Vertiv and contains confidential and proprietary information owned by Vertiv. Any copying, use, or disclosure of it without the written permission of Vertiv is strictly prohibited.

Names of companies and products are trademarks or registered trademarks of the respective companies. Any questions regarding usage of trademark names should be directed to the original manufacturer.

Technical Support Site

If you encounter any installation or operational issues with your product, check the pertinent section of this manual to see if the issue can be resolved by following outlined procedures.

Visit <https://www.vertiv.com/en-us/support/> for additional assistance.

TABLE OF CONTENTS

1 Important Safety Instructions	1
1.1 General	6
1.2 Installation/Handling	6
1.3 Application	7
1.4 Warranty	7
1.5 Electrical Connection	7
1.6 Replacement Parts	8
1.7 Waste Disposal	8
1.8 Documentation	8
2 Agency	9
2.1 Product Standards and Approvals	9
2.2 ROHS 2 Compliance	9
3 Product Description	11
3.1 General	11
3.2 Features and Benefits	11
3.3 Vertiv™ Liebert® XDU450 Model Number Nomenclature	12
3.4 Product Views	14
3.5 Cabinet and Piping Views	17
3.6 Product Accessories	20
4 Technical Data	23
4.1 General	23
4.2 Electrical Data	25
4.3 Pipe Connections	26
4.4 Pressure Limitations	27
4.5 Primary (Facility) Circuit	27
4.6 Secondary Circuit	32
4.7 Wetted Materials	33
5 Communications	35
5.1 Group Control	35
5.2 Remote Monitoring and Control	36
Appendices	37
Appendix A: Technical Support and Contacts	37
Appendix B: Pipe Schematic Vertiv™ Liebert® XDU450	39
Appendix C: Graphs	41
Appendix D: Modbus Register Table	47
Appendix E: Vertiv™ Liebert® XDU450 BACnet Points List	53
Appendix F: Warranty Details	57
Appendix G: Notes	59

Appendix H: Disposal Information 61

1 Important Safety Instructions

Save These Instructions

This manual contains important instructions that should be followed during operation and maintenance of the Vertiv™ Liebert® XDU450.



WARNING! Arc flash and electric shock hazard. Can cause serious injury or death. Building and equipment damage may also result. Disconnect all local and remote electric power supplies and wear appropriate, OSHA-approved personal protective equipment (PPE) per NFPA 70E before working within the electric control enclosure. Customer must provide earth ground to unit, per NEC, CEC and local codes, as applicable.

Verify with a voltmeter that power is Off. The Vertiv™ Liebert® iCOM™ controller does not isolate power from the unit, even in the “Unit Off” mode. Some internal components still require and receive power even during the “Unit Off” mode of the Liebert® iCOM™ controller. The factory-supplied, disconnect switch is inside the unit. The line side of this switch contains live high voltage. The only way to ensure that there is NO voltage inside the unit is to install and open a remote disconnect switch. Refer to unit electrical schematic.

Before proceeding with installation, read all instructions, verify that all the parts are included and check the nameplate to be sure the voltage matches available utility power. Follow all local codes.



WARNING! Risk of electric shock. Can cause serious injury or death. Building and equipment damage may also result. Open all local and remote electric power supply disconnect switches and verify that power is off with a voltmeter before working within any electric connection enclosures. The Liebert® iCOM™ controller does not isolate power from the unit, even in the "Unit Off" mode. Some internal components require and receive power even during the "unit off" mode of the Liebert® iCOM™ controller.

Installation, service, and maintenance work must be performed only by properly trained and qualified personnel and in accordance with applicable regulations and manufacturers' specifications. Opening or removing the covers to any equipment may expose personnel to lethal voltages within the unit even when it is apparently not operating and the input wiring is disconnected from the electrical source.



WARNING! Risk of short circuits and electric shock. Can cause serious injury or death. Building and equipment damage can result from cut insulation or damaged wires. Can cause overheated wiring, smoke, fire, and activation of fire suppression systems and EMS personnel. Verify that all wiring connections are tight and that all wiring is contained within the junction box prior to closing and securing the cover.

Insert CSA-certified or UL-listed bushings into holes and/or knockouts used to route wiring through metal panels to protect the wire insulation from contact with sheet metal edges.



WARNING! Risk of improper wire sizing/rating and loose electrical connections causing overheated wire and electrical connection terminals resulting in smoke or fire. Can cause serious injury or death. Building and equipment damage may also result. Use correctly sized copper wire only and verify that all electrical connections are tight before turning power On. Check all electrical connections periodically and tighten as necessary.



WARNING! Risk of improper wiring, piping, moving, lifting and handling. Can cause serious injury or death. Building and equipment damage may also result. Installation and service of this equipment should be done only by qualified personnel who have been specially-trained in the installation of air-conditioning equipment and who are wearing appropriate, OSHA-approved PPE.



WARNING! Risk of improper moving. Can cause serious injury or death. Building and equipment damage may also result. Use only lifting equipment that is rated for the unit weight by an OSHA-certified rating organization. Shipping weights and unit weights are listed in the tables in [General](#) on page 23 . Use the center of gravity indicators on the unit to determine the position of the slings.



WARNING! Risk of top-heavy unit falling over when improperly lifted or moved. Can cause serious injury or death. Building and equipment damage may also result. Read all of the following instructions and verify that all lifting and moving equipment is rated for the weight of the unit before attempting to move, lift, remove packaging from or prepare the unit for installation. Unit weights are specified in [General](#) on page 23 .



WARNING! Risk of unsecured unit rolling off pallet. Can cause serious injury or death. Building and equipment damage may also result. The unit is on casters. Ensure that the unit and pallet is located on a flat surface before loosening the hardware securing the unit to its shipping pallet.



CAUTION: Risk of contact with extremely hot or cold surfaces. Can cause injury. Verify that all components have reached a temperature that is safe for human contact or wear appropriate, OSHA-approved PPE before working with the electric connection enclosures or unit cabinet. Perform maintenance only when the system is de-energized and component temperatures have become safe for human contact.



CAUTION: Risk of contact with sharp edges, splinters and exposed fasteners. Can cause injury. Only properly trained and qualified personnel wearing appropriate, OSHA-approved PPE should attempt to move, lift, remove packaging from or prepare the unit for installation.



CAUTION: Risk of improper handling heavy and lengthy parts. Can cause injury. Building and equipment damage may also result. Cabinet panels can exceed 5 ft. (1.5 m) in length and weigh more than 35 lb (15.9 kg). Follow relevant OSHA lifting recommendations and consider using a two-person lift for safe and comfortable removal and installation of cabinet panels. Only properly trained and qualified personnel wearing appropriate, OSHA-approved PPE should attempt to remove or install cabinet panels.



CAUTION: Risk of improper piping installation, leak checking, fluid chemistry and fluid maintenance. Can cause injury. Building and equipment damage may also result. Installation and service of this equipment should be done only by qualified personnel who have been specially-trained in the installation of air-conditioning equipment and who are wearing appropriate, OSHA-approved PPE.

NOTICE

Risk of improper power-supply connection. Can cause equipment damage and loss of warranty coverage. Prior to connecting any equipment to a main or alternate power source (for example back-up generator systems) for start-up, commissioning, testing, or normal operation, ensure that these sources are correctly adjusted to the nameplate voltage and frequency of all equipment to be connected. In general, power-source voltages should be stabilized and regulated to within +/- 5% of the load nameplate nominal voltage. Also, ensure that no three-phase sources are single-phased at any time. See transformer label for primary tap connections. Installer will need to change transformer primary taps if applied unit voltage is other than pre-wired tap voltage.

NOTICE

Risk of improper electrical connection of three-phase input power. Can cause backward pump rotation and unit damage. Service technicians should use a gauge set on the system during the initial start up to verify that the three-phase power is connected properly. Three-phase power must be connected to the unit line voltage terminals in the proper sequence so that the pump rotates in the proper direction. Incoming power must be properly phased to prevent pump from running backward. We recommend checking the unit's phasing with proper instrumentation to ensure that the power connections were made correctly. We also recommend verifying discharge and suction pressures during start up to ensure that the pumps are running in the correct direction.

NOTICE

Risk of piping-system corrosion and freezing fluids. Can cause leaks resulting in equipment and very expensive building damage. Heat exchangers and piping systems are at high risk of freezing and premature corrosion. Fluids in these systems must contain the proper antifreeze and inhibitors to prevent freezing and premature coil and piping corrosion. When the cooling unit or piping may be exposed to freezing temperatures, charge the system with coolant fluid based on the coldest ambient design temperature. Automotive antifreeze is unacceptable and must NOT be used in any fluid system. Use only coolant fluid solution that meets the requirements of recommended industry practices. Do not use galvanized pipe.

The system coolant fluid must be analyzed by a competent fluid-treatment specialist before start up to establish the inhibitor and antifreeze solution requirement and evaluated at regularly scheduled intervals throughout the life of the system to determine the pattern of inhibitor depletion.

The fluid complexity and variants of required treatment programs make it extremely important to obtain the advice of a competent and experienced fluid-treatment specialist and follow a regularly scheduled coolant-fluid system-maintenance program.

Fluid chemistry varies greatly as do the required additives, called inhibitors, that reduce the corrosive effect of the fluids on the piping systems and components.

The chemistry of the coolant fluid used must be considered, because some sources may contain corrosive elements that reduce the effectiveness of the inhibited formulation. Sediment deposits prevent the formation of a protective oxide layer on the inside of the coolant system components and piping. The coolant fluid must be treated and circulating through the system continuously to prevent the buildup of deposits and/or growth of sulfate reducing bacteria. Proper inhibitor maintenance must be performed to prevent corrosion of the system.

Consult fluid manufacturer for testing and maintenance of inhibitors.

Commercial-grade coolant fluid is generally less corrosive to the common metals of construction than water itself. It will, however, assume the corrosivity of the coolant fluid from which it is prepared and may become increasingly corrosive with use if not properly inhibited.

Vertiv recommends installing a monitored fluid-detection system that is wired to activate the automatic-closure of field-installed coolant-fluid supply and return shut-off valves to reduce the amount of coolant-fluid leakage and consequential equipment and building damage. The shut-off valves must be sized to close-off against the maximum coolant-fluid system pressure in case of a catastrophic fluid leak.

NOTICE

Risk of no-flow condition. Can cause equipment damage. Do not leave the water/coolant fluid-supply circuit in a no-flow condition. Idle fluid allows the collection of sediment that prevents the formation of a protective oxide layer on the inside of the tubes. Keep unit switched On and water/ coolant fluid-supply circuit system operating continuously.

NOTICE

Risk of leaking chilled water lines. Can cause equipment and building damage.

Lines and joints must be inspected regularly. Improper installation, application and service practices can result in water leakage from the unit. Water leakage can result in severe property damage and loss of critical data center equipment. Do not locate unit directly above any equipment that could sustain water damage.

Vertiv recommends installing monitored leak detection equipment for the unit and supply and return lines.

NOTICE

Risk of a catastrophic water circuit rupture. Can cause expensive building and equipment damage.

Install an overflow drain pan under the unit with a monitored leak detection system in the pan and shutoff valves in the supply and return water lines that automatically close if water is detected by the leak detection system. The shutoff valves should be spring return and must be rated for a close-off pressure that is the same as or higher than the supply water pressure. If it is not possible to install an overflow drain pan, then a monitored leak detection system should be installed in the base of the unit or under the unit to actuate the shutoff valves immediately on a leak detection signal.

The overflow drain pan should have a drain line connected to it that flows to a floor drain or maintenance sink in case of a shutoff valve or leak detection system malfunction.

NOTICE

Risk of passageway interference. Can cause unit and/or structure damage. The unit may be too large to fit through a passageway while on or off the skid. Measure the unit and passageway dimensions, and refer to the installation plans prior to moving the unit to verify clearances.

NOTICE

Risk of damage from forklift. Can cause unit damage. Keep tines of the forklift level and at a height suitable to fit below the skid and/or unit to prevent exterior and/or underside damage.

NOTICE

Risk of improper storage. Can cause unit damage.

Keep the unit upright, indoors and protected from dampness, freezing temperatures and contact damage.

NOTICE

Risk of improper control circuits. Can cause equipment damage.

When using jumpers for troubleshooting, always remove jumpers when maintenance is complete. Jumpers left connected could override controls and cause equipment damage.

1.1 General

Mechanical and electrical equipment such as fluid distribution units present potential mechanical and electrical hazards. All safety, installation, operation, and maintenance instructions must be adhered to. Any work on or use of the equipment must only be carried out by technically competent personnel who are fully trained. This product is designed to minimize all potential hazards by restricting access through unit casings, doors, and covers while equipment is operational.

Before any maintenance work being carried out, ensure:

1. Equipment is switched OFF.
2. Equipment and controls are disconnected from the electrical supply.
3. All rotating parts such as pumps and 3-way valve have come to rest.

If in any doubt over anything regarding safety, installation, operation or maintenance instructions, it is essential that the manufacturer, their agent or appointed representative is consulted for clarification and advice.

1.2 Installation/Handling



WARNING! Risk of improper wiring, piping, moving, lifting and handling. Can cause serious injury or death. Building and equipment damage may also result. Installation and service of this equipment should be done only by qualified personnel who have been specially-trained in the installation of air-conditioning equipment and who are wearing appropriate, OSHA-approved PPE.



WARNING! Risk of improper moving. Can cause serious injury or death. Building and equipment damage may also result. Use only lifting equipment that is rated for the unit weight by an OSHA-certified rating organization. Shipping weights and unit weights are listed in the tables in [General](#) on page 23 .



WARNING! Risk of top-heavy unit falling over when improperly lifted or moved. Can cause serious injury or death. Building and equipment damage may also result. Read all of the following instructions and verify that all lifting and moving equipment is rated for the weight of the unit before attempting to move, lift, remove packaging from or prepare the unit for installation. Unit weights are specified in [General](#) on page 23 .



WARNING! Risk of unsecured unit rolling off pallet. Can cause serious injury or death. Building and equipment damage may also result. The unit is on casters. Ensure that the unit and pallet is located on a flat surface before loosening the hardware securing the unit to its shipping pallet.



CAUTION: Risk of contact with sharp edges, splinters and exposed fasteners. Can cause injury. Only properly trained and qualified personnel wearing appropriate, OSHA-approved PPE should attempt to move, lift, remove packaging from or prepare the unit for installation.

NOTICE

Risk of passageway interference. Can cause unit and/or structure damage. The unit may be too large to fit through a passageway while on or off the skid. Measure the unit and passageway dimensions, and refer to the installation plans prior to moving the unit to verify clearances.

NOTICE

Risk of damage from forklift. Can cause unit damage. Keep tines of the forklift level and at a height suitable to fit below the skid and/or unit to prevent exterior and/or underside damage.

Installation and operation must be conducted in accordance with local and national regulations and normal codes of good practice. When moving or lifting the product, caution must be observed to ensure the safety of personnel. Only the appropriate lifting equipment must be used.

1.3 Application

This product is to be used indoors only and must only be used for the application it was designed for. This product must not be used in a hazardous environment.

1.4 Warranty

Failure to comply with the Vertiv installation, maintenance, and operation instructions may affect the reliability and performance of the unit and invalidate any warranty.

1.5 Electrical Connection



WARNING! Arc flash and electric shock hazard. Can cause serious injury or death. Building and equipment damage may also result. Disconnect all local and remote electric power supplies and wear appropriate, OSHA-approved personal protective equipment (PPE) per NFPA 70E before working within the electric control enclosure. Customer must provide earth ground to unit, per NEC, CEC and local codes, as applicable.

Verify with a voltmeter that power is Off. The Vertiv™ Liebert® iCOM™ controller does not isolate power from the unit, even in the "Unit Off" mode. Some internal components still require and receive power even during the "Unit Off" mode of the Liebert® iCOM™ controller. The factory-supplied, optional disconnect switch is inside the unit. The line side of this switch contains live high voltage. The only way to ensure that there is NO voltage inside the unit is to install and open a remote disconnect switch. Refer to unit electrical schematic.

Before proceeding with installation, read all instructions, verify that all the parts are included and check the nameplate to be sure the voltage matches available utility power. Follow all local codes.



WARNING! Risk of electric shock. Can cause serious injury or death. Building and equipment damage may also result. Open all local and remote electric power supply disconnect switches and verify that power is off with a voltmeter before working within any electric connection enclosures. The Liebert® iCOM™ controller does not isolate power from the unit, even in the "Unit Off" mode. Some internal components require and receive power even during the "unit off" mode of the Liebert® iCOM™ controller.

Installation, service, and maintenance work must be performed only by properly trained and qualified personnel and in accordance with applicable regulations and manufacturers' specifications. Opening or removing the covers to any equipment may expose personnel to lethal voltages within the unit even when it is apparently not operating and the input wiring is disconnected from the electrical source.



WARNING! Risk of improper wire sizing/rating and loose electrical connections causing overheated wire and electrical connection terminals resulting in smoke or fire. Can cause serious injury or death. Building and equipment damage may also result. Use correctly sized copper wire only and verify that all electrical connections are tight before turning power On. Check all electrical connections periodically and tighten as necessary.

NOTICE

Risk of improper power-supply connection. Can cause equipment damage and loss of warranty coverage.

Prior to connecting any equipment to a main or alternate power source (for example back-up generator systems) for start-up, commissioning, testing, or normal operation, ensure that these sources are correctly adjusted to the nameplate voltage and frequency of all equipment to be connected. In general, power-source voltages should be stabilized and regulated to within +/- 5% of the load nameplate nominal voltage. Also, ensure that no three-phase sources are single-phased at any time.

See transformer label for primary tap connections. Installer will need to change transformer primary taps if applied unit voltage is other than pre-wired tap voltage.

NOTICE

Risk of improper electrical connection of three-phase input power. Can cause backward pump rotation and unit damage. Service technicians should use a gauge set on the system during the initial start up to verify that the three-phase power is connected properly. Three-phase power must be connected to the unit line voltage terminals in the proper sequence so that the pump rotates in the proper direction. Incoming power must be properly phased to prevent pump from running backward. We recommend checking the unit's phasing with proper instrumentation to ensure that the power connections were made correctly. We also recommend verifying discharge and suction pressures during start up to ensure that the pumps are running in the correct direction.

Electrical connections should be carried out in accordance with local and national regulations by a qualified electrician. Never make any electrical connections inside, or to the unit unless the electricity supply has been switched OFF at the disconnect (isolator).

1.6 Replacement Parts

Any parts replaced during maintenance or servicing must be the same specification as those being replaced and should only be obtained from Vertiv.

The use of incorrect replacement parts may affect the operation or reliability of the unit and invalidate any warranty.

1.7 Waste Disposal

Any waste or single use materials must be disposed of in a responsible manner and in strict adherence to local and national environmental regulations. For details, consult local environmental agencies.

1.8 Documentation

Operation and maintenance documentation together with commissioning, maintenance or service records must remain with the unit always.

2 Agency

2.1 Product Standards and Approvals

Vertiv products installed and operated in compliance with this document, the operation and maintenance guide and installation and commissioning guide, conform to the Low Voltage directive 2014/35/EU, the EMC directive 2014/30/EU and the Pressure Equipment directive 2014/68/EU. As manufactured, Vertiv products are designed to comply with an IP21 rating. This product is cUL listed for the appropriate voltage models and certificates will be made available on request (cUL certificate pending).



2.2 ROHS 2 Compliance

Vertiv certifies that all products manufactured and supplied by Vertiv are fully RoHS compliant in accordance with EU RoHS Directives 2002/95/EC – 2011/65/EU and the Council of 8 June 2011 directives, unless specified otherwise.



This page intentionally left blank

3 Product Description

3.1 General

This document describes the performance, possible configurations, application, and specification of the Vertiv™ Liebert® XDU450.

The Liebert® XDU450 contains a Secondary closed loop circuit that provides a supply of cooling fluid to IT equipment, either through indirect cooling (e.g. rack mounted rear door heat exchangers), or direct cooling (e.g. cold plates at chip level).

The Secondary circuit is a low pressure sealed system with the heat removed from the high heat density areas of IT equipment rejected to an external cooled water source (Primary circuit) via a low pressure drop plate heat exchanger.

The Secondary circuit ensures that the cooling fluid in a data center environment can be kept to a minimum volume, is closely controlled for flow, pressure, and temperature (with condensation control) and can be accurately maintained for fluid quality (with filtration and additives).

The Primary cooling source can be a chilled water system (either dedicated or from building system), fluid cooler, cooling tower or drycooler, depending on the desired Secondary temperature and heat transfer duty (refer to [Primary \(Facility\) Circuit](#) on page 27 and [Secondary Circuit](#) on page 32 for more information).

3.2 Features and Benefits

- Essential separation of the primary (facility) water from the IT equipment, providing low pressure, clean water to liquid cooled IT equipment.
- Low water volume in secondary loop, reducing leak risk.
- N+N pumps, inverters, expansion vessels, pressure and temperature sensors for built-in redundancy.
- Large pipe diameter and optimal hydraulic design with low pressure drop, provides maximum secondary flow up to 132 gpm (500 l/m) at external pressure drop of 49.3 psi (3.4 bar) - without filtration **both pumps running**. For **single pump operation** maximum secondary flow up to 119 gpm (450 l/m) at external pressure drop of 24.0 psi (1.6 bar) - without filtration).
- Sanitary flange and clamp design, easy installation, maintenance and retrofit of pipework parts.
- Connection options available for top or bottom pipe exit and manifolds giving application flexibility.
- Large surface area heat exchanger to provide high cooling capacity with low approach temperatures.
- Secondary water control in differential pressure control mode or flow rate control mode to suit various application requirements.
- Secondary water temperature controlled within $\pm 1.8^{\circ}\text{F}$ (1°C), to ensure cooling stability with variable heat load.
- Group control available for multiple XDUs via CANbus, enables N+X redundancy design for larger installations.
- Modbus RTU RS485 and TCP/IP communication with data center monitoring system for easy integration.
- Full alarm monitoring, providing real-time status of the IT equipment and the local environment.
- Data, alarm and system logging over the full product lifetime to on-board SD card (minimum size 4 GB).
- 4.3 kW power consumption (single pump running mode) to provide up to 500 kW cooling capacity, high energy efficiency.
- Supports warm water cooling in direct contact liquid cooling applications, very low partial PUE cooling, energy saving and OpEx benefits for user.
- Small footprint 23.6 x 41.1 in. (600 x 1043 mm), black textured finish to blend in with computer room environment.
- International service team, to provide professional and all in one services from installation to maintenance and troubleshooting.
- Primary circuit is insulated to prevent sweating. The secondary circuit to the customer connected equipment is not insulated (typically secondary loop is above the ambient dew point).

3.3 Vertiv™ Liebert® XDU450 Model Number Nomenclature

The Liebert® XDU450 can be configured for Voltage option to suit any global location, Primary/Secondary filtration, Primary Top/Bottom connections and Secondary Top/Bottom connections, or Secondary Manifold ready (i.e. ready to accept an external manifold across the rear of the XDU450, or multiple XDU450s).

Table 3.1 below is an example of the Liebert® XDU450 model number, fully configured. **Table 3.2** below describes each digit of the model number.

Table 3.1 Liebert® XDU450 Model Number

Digit	1	2	3	4	5	6	7	8	9	10	11	12	13	14	15	16	17	18	19	20	21	22	23	24	25	
Model #	X	D	U	0	4	5	0	A	A	0	0	A	2	B	B	0	0	0	0	0	0	1	2	3	4	E

Table 3.2 Liebert® XDU450 Model Number Definitions

Digit	Description
Digit 1-7, Model	Liebert® XDU450
Digit 8, Revision	A
Digit 9, Voltage	A = 460V/3PH/60Hz C = 208V/3PH/60Hz
Digit 10, ATS	0 = None C = ATS 200/208V A = ATS 440/480V
Digit 11, Communication	0 = Standard (Modbus) 1 = Standard with BACnet Gateway
Digit 12, Primary Filtration	0 = None 1 = Fitted (500µ)
Digit 13, Secondary Filtration	0 = None (includes 6 bar relief) 2 = Fitted (50µ) (includes 3 bar relief)
Digit 14, Primary Connection	T = Top Connection B = Bottom Connection
Digit 15, Secondary Connection	T = Top Connection Kit B = Bottom Connection Kit M = Manifold Ready

Table 3.2 Liebert® XDU450 Model Number Definitions (continued)

Digit	Description
Digit 16, Manifolding	O = None P = 6-way header with 1" BSP(P) thread R = 6-way header with 1" BSP BV valve S = 6-way header with 1" BSP BV/DRV valve T = 8-way header with 1" BSP thread U = 8-way header with 1" BSP BV valve V = 6-way header with 1" NPT (P) thread W = 6-way header with 1" NPT 8V valve X = 6 way header with 1" NPT/DRV valve Y = 8-way header with 1" NPT thread Z = 8-way header with 1" NPT BV valve
Digit 17	Open
Digit 18	Open
Digit 19	Open
Digit 20	Open
Digit 21-24, Factory Configuration	-
Digit 25, Configuration Code Digit	A-Z = Standard Configuration (excluding S) S = Special Feature Authorization

3.4 Product Views

Figure 3.1 Front View of Vertiv™ Liebert® XDU450 (without panels)

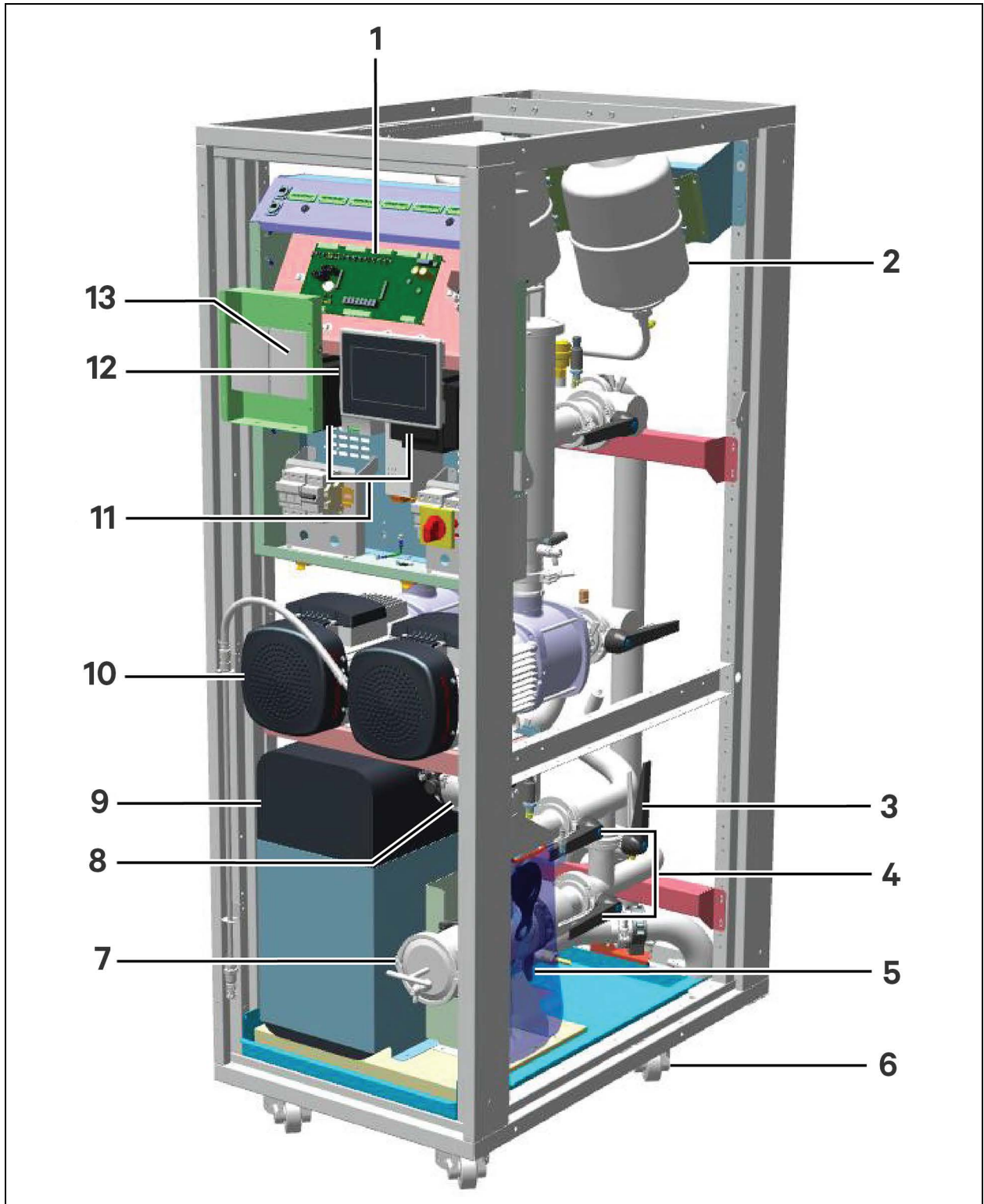

Number	Description
1	Controller/processor
2	Expansion vessels
3	Primary filter by-pass valve (if fitted)
4	Primary filter isolation valves (if fitted)
5	Water make-up container
6	Wheels and adjustable feet
7	Primary filter (optional)
8	Filling pump
9	Plate heat exchanger
10	Secondary pumps (dual pump unit shown)
11	Pump inverter drives
12	Controller touch screen (mounted to front door)
13	Room temperature and RH sensors (mounted to front door)

Figure 3.2 Rear View of Vertiv™ Liebert® XDU450 (with bottom exit Primary and Secondary tails)

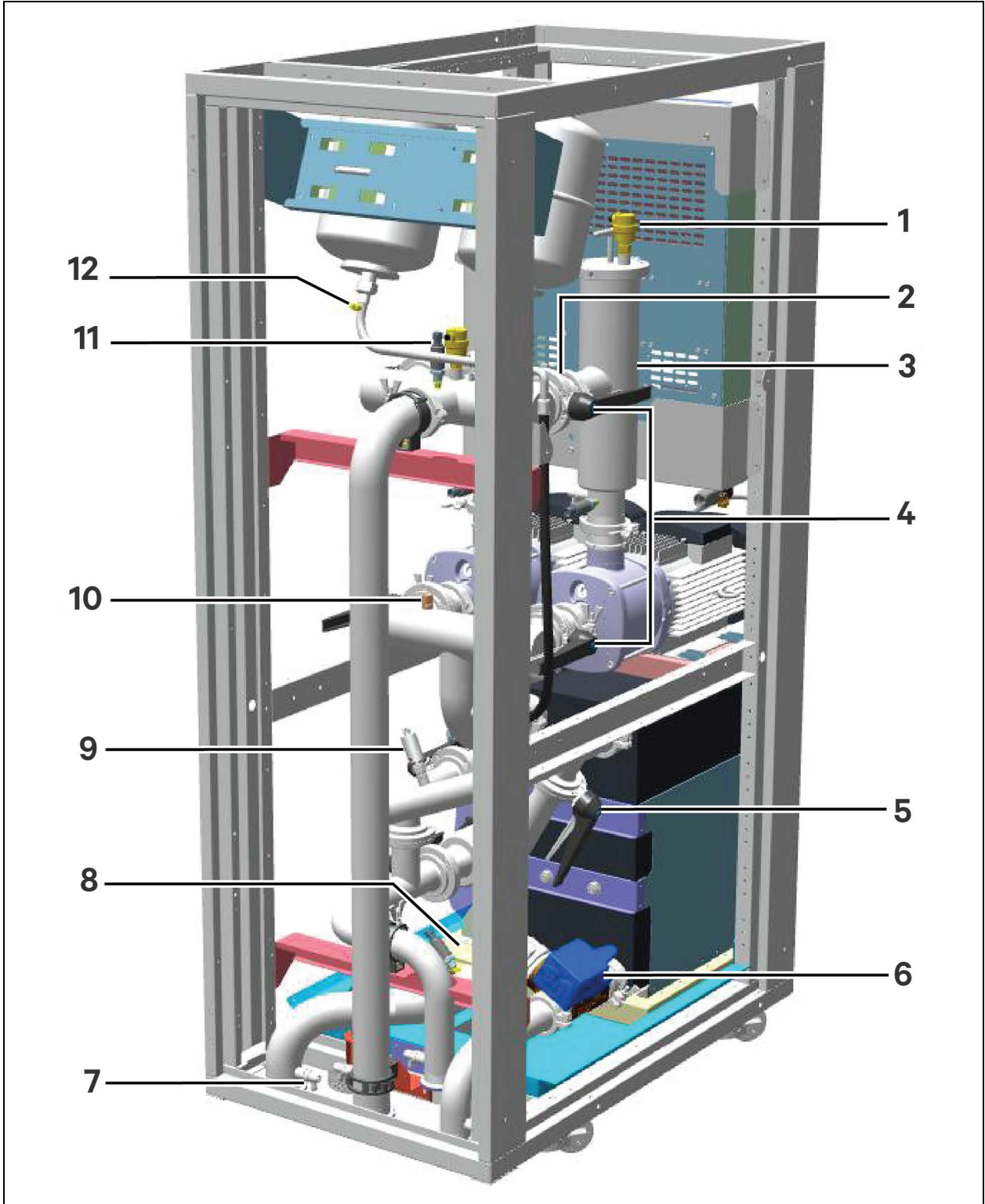

Number	Description
1	Auto air vent (fitted to each filter housing)
2	Pressure relief valve (6 bar standard)
3	Optional secondary filters (includes 3 bar pressure relief valve in place of standard 6 bar)
4	Filter/pump isolation valves
5	By-pass shut-off valve (Closed to convert 3-way primary control valve to 2-way)
6	Primary cooling valve (3-way with manual override)
7	Drain valves
8	Secondary flow meter
9	Primary flow meter
10	Level sensors
11	Pressure sensors
12	Manual air vents (fitted beneath expansion vessels)

3.5 Cabinet and Piping Views

Unit primary connections to facility water source can be configured for top or bottom connection. Connections are made to 2 inch (DN50) sanitary style flanges directly to field piping system or through optional Vertiv supplied flexible hoses.

The secondary 2-1/2 inch (DN65) connections to the IT loop can be configured for top, bottom or manifold connections. The top and bottom connection are made to sanitary style flanges directly to field piping system or through optional Vertiv supplied flexible hoses.

Figure 3.3 Rear Section Showing Primary and Secondary Pipe Connection Locations

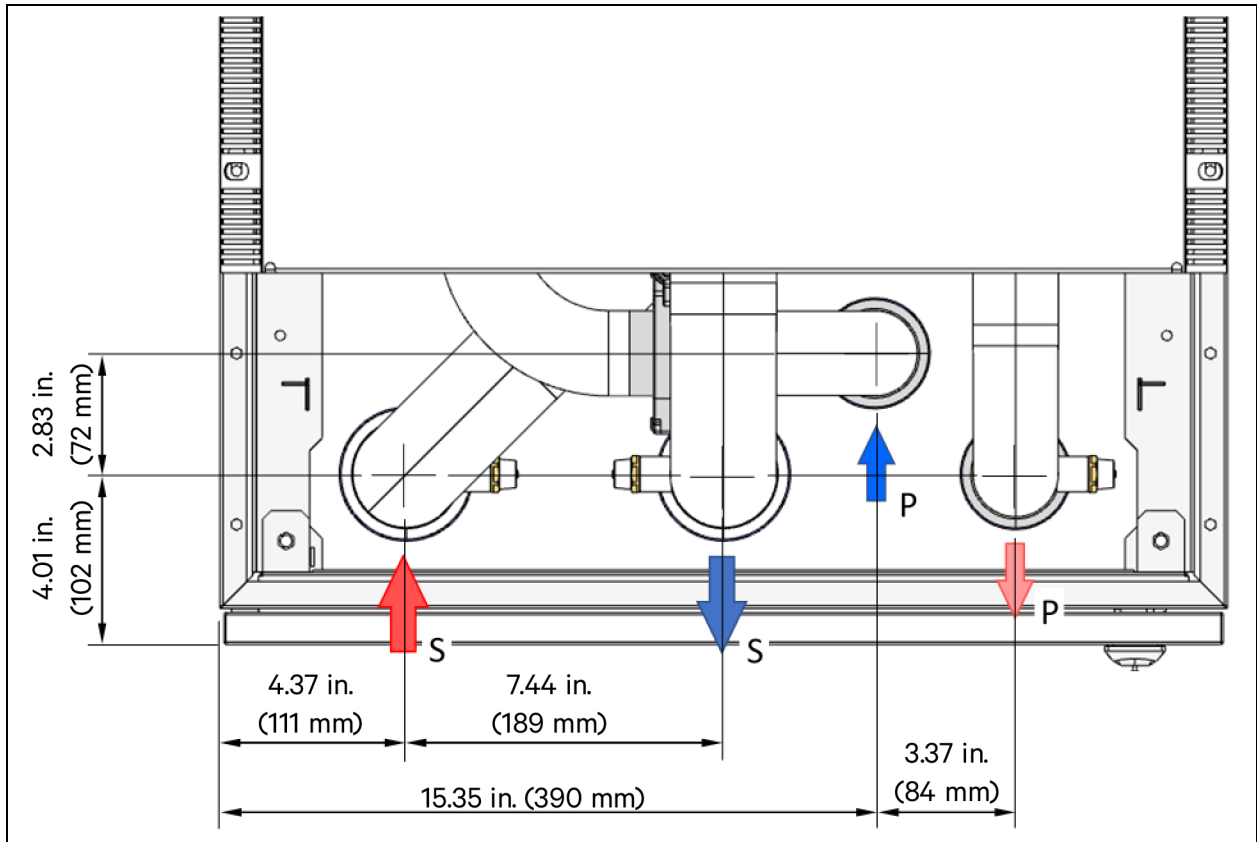

Plan view of Vertiv™ Liebert® XDU450 rear section showing Primary and Secondary circuit pipe connection locations. Positions will be the same for both Bottom and Top Exit pipework.

- S = Secondary Circuit
- P = Primary Facility Circuit

Adapters for the Primary 2 inch (DN50) and Secondary 2½ inch (DN65) sanitary flanges can be provided if required to suit site requirements.

See also a list of available accessories in [Product Accessories](#) on page 20 .

Units provided with the manifold connection option include a cabinet extension for housing the manifolds. The Secondary manifolds are available with 6 or 8-way connections. The connections are available in 1 inch NPT or BSP(P) thread and can be selected as threaded, threaded ball valve or threaded ball valve/threaded regulating valve and fitted in a cabinet 6.18 inch (157 mm) extension (see **Figure 3.4** below).

Figure 3.4 Vertiv™ Liebert® XDU450 Cabinet and Piping Dimensions

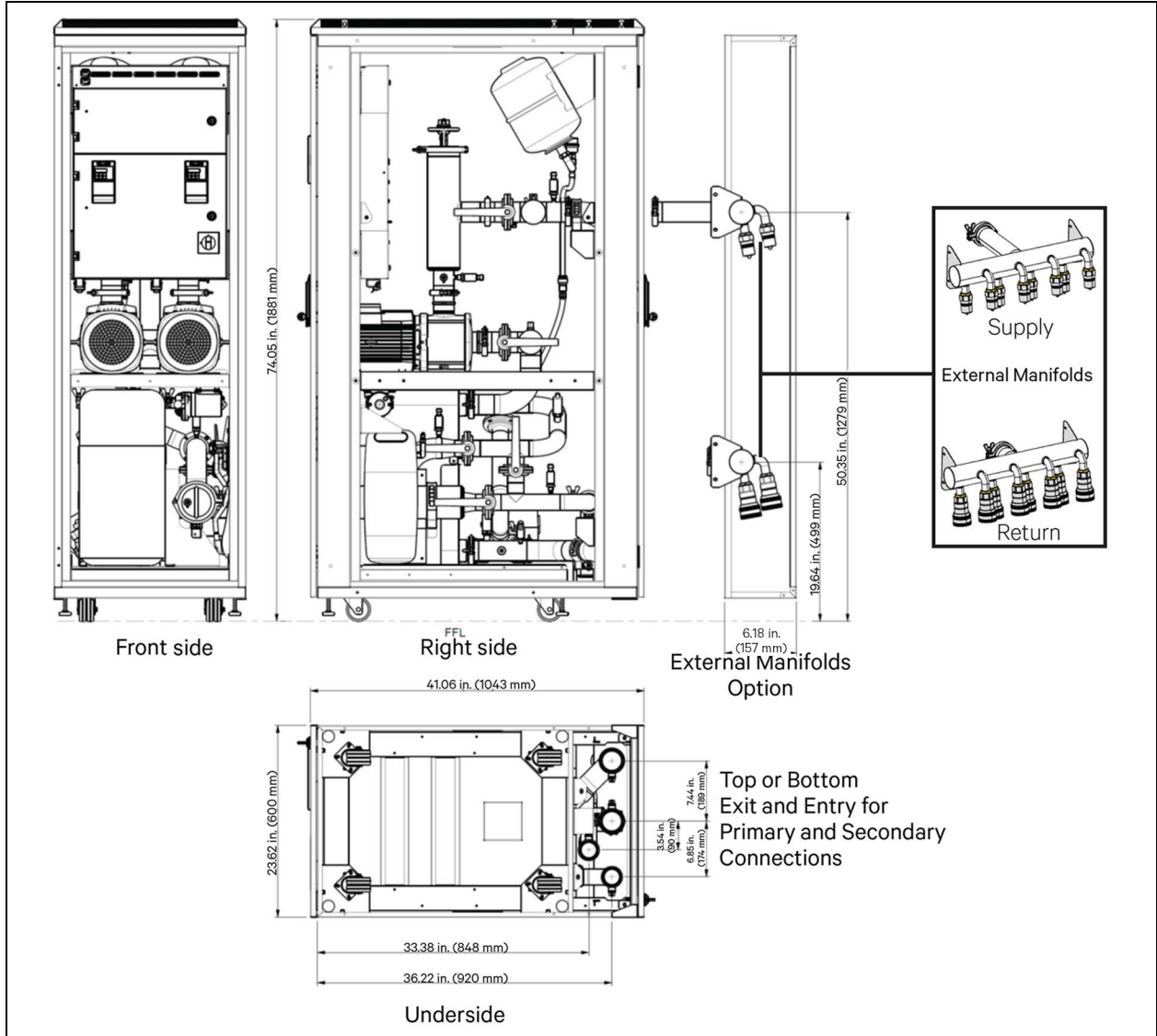

3.6 Product Accessories

For a complete installation solution, any of the following accessories may be ordered as optional extras, if required. Please contact the Vertiv™ Liebert® XDU450 manufacturer for more details.

Table 3.3 Factory Installed Accessories

Description
Automatic Transfer Switch (ATS) for dual power supplies (400/480 v)
Automatic Transfer Switch (ATS) for dual power supplies (200/208 v)
Primary connections 2 in. Top
Primary Connections 2 in. Bottom
Secondary Connections 2-1/2 in. Top
Secondary Connections 2-1/2 in. Bottom
Manifold Ready and Cabinet Extension
Internal Manifold (X-no. of ways, Y-connection type)
** See Table 3.5 on the facing page for options.

Table 3.4 Ship Loose Accessories

Description
Leak Detection Tape (32 ft./10 m) - other lengths available
Tie Down Unit
2 in. Stainless Steel Connection Hose Set - Primary Facility Hose Set
2-1/2 in. Stainless Steel Connection Hose Set - Secondary Hose Set
** See Table 3.5 on the facing page for options.

Table 3.5 Hose and Manifold Options

<p>Number of manifold connections:</p> <ul style="list-style-type: none"> • 6-way • 8-way 	<p>Connection type:</p> <ul style="list-style-type: none"> • 1 in. BSP(P) thread connection/thread connection • 1 in. BSP(P) ball valve/ball valve • 1 in. BSP(P) ball valve/regulating valve (6-way only) • 1 in. NPT thread connection/thread connection • 1 in. NPT ball valve/ball valve • 1 in. NPT ball valve/regulating valve (6-way only)
<p>Primary Facility hose length set:</p> <ul style="list-style-type: none"> • 1.64 ft. (0.5 m) • 3.28 ft. (1 m) • 4.92 ft. (1.5 m) • 6.56 ft. (2 m) • 8.2 ft. (2.5 m) • 9.84 ft. (3 M) 	<p>Primary Facility hose end connection:</p> <p>2 in. ANSI 150# flange</p>
<p>Secondary hose length set:</p> <ul style="list-style-type: none"> • 1.64 ft. (0.5 M) • 3.28 ft. (1 M) • 4.92 ft. (1.5 M) • 6.56 ft. (2 M) • 8.2 ft. (2.5 M) • 9.84 ft. (3 M) 	<p>Secondary hose end connection:</p> <p>2-1/2 in. ANSI 150# flange</p>
<p>NOTE: Contact Vertiv for exact requirements.</p>	

This page intentionally left blank

4 Technical Data

4.1 General

Table 4.1 Vertiv™ Liebert® XDU450 Specifications

XDU450 Specifications:						
Nominal Cooling Capacity	453 kW at 7.2°F (4.0°C) Approach Temperature Difference (ATD)*					
Maximum Cooling Capacity	975 kW at 14.4°F (8.0°C) Approach Temperature Difference (ATD)*					
Maximum Flow - Single Pump Running	119 gpm (450 l/m) at 29 psi (2.0 bar) External Differential Pressure to XDU (DP)					
Maximum Flow - Dual Pump Running for N+ Operation	132 gpm (500 l/m) at 49.3 psi (3.4 bar) External Differential Pressure to XDU (DP)					
Coolant Type	Water, water/glycol or any compatible sensible phase liquid					
Primary Coolant Type	Water, water/glycol					
Pump Redundancy	Single pump (N), dual pumps (N+N) or dual pump run mode					
Primary Pressure Drop	11.5 psi (0.8 bar) at typical 79.2 gpm (300 l/m) with 20% glycol					
Secondary Coolant Temperature Range	50 to 131°F (10 to 55°C) with dew point control standard					
Maximum Power Consumption	4.5 kW at maximum flow and external pressure drop					
Dimensions	Height		Width		Depth	
Unit	in.	mm	in.	mm	in.	mm
Standard Cabinet	74.8	1900	23.6	599	41	1041
With Manifold and extended cabinet	74.8	1900	23.6	599	47	1194
Standard Cabinet with ATS	81.1	2060	23.6	599	41	1041
With Manifold extended cabinet and ATS	81.1	2060	23.6	599	47	1194
Shipping (Domestic)						
Standard Cabinet	82.7	2101	29.5	749	47.2	1199
With Manifold and extended cabinet	82.7	2101	29.5	749	57.1	1450
Standard Cabinet with ATS	89	2261	29.5	749	47.2	1199
With Manifold, extended cabinet and ATS	89	2261	29.5	749	57.1	1450
Weight	Dry		Operating		Shipping	
	lbs.	kg	lbs.	kg	lbs.	kg
Standard Cabinet	848	385	910	413	1143	518
With Manifold and extended cabinet	890	404	938	425	1225	556
Standard Cabinet with ATS	881	400	943	428	1196	543
With Manifold, extended cabinet and ATS	923	419	971	440	1258	571

Table 4.1 Vertiv™ Liebert® XDU450 Specifications (continued)

XDU450 Specifications:		
Circuit Fluid Volume		
Primary	Gallons	Liters
Base Unit	5.86	22.18
Filters	1.08	4.09
Bottom Connection Piping	0.34	1.29
Top Connection Piping	1.63	6.17
Secondary		
Base Unit	8.4	31.80
Filters	1.32	5.00
Bottom Connection Piping	1.45	5.49
Top Connection Piping	2.13	8.06
Manifolds	1.96	7.42
Noise Level at 3m (10 ft.)	< 54 dBA (sound pressure)	
Dual Power Feeds (ATS)	Optional feature	
Other Sensors	Ambient/Room RH and Temperature (redundancy option)	
Agency Approvals and Certification	CE, cULus, RoHS	
*ATD - Approach Temperature Difference		

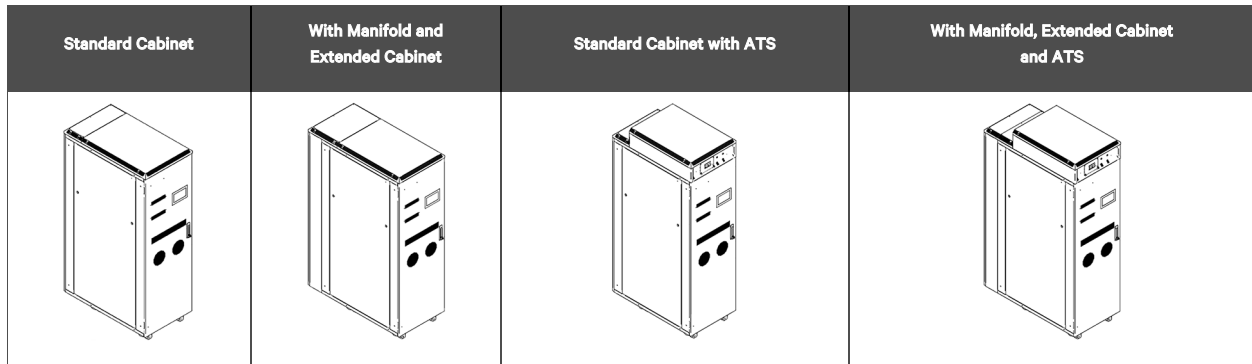

4.2 Electrical Data

Table 4.2 Supported Power Supplies

Voltage	FLA	WSA	OPD
208*	16.8 A	30 A	50 A
480**	15.0 A	30 A	40 A
Installed load	12.5 kVA (max.)		
Typical Power	7.5 kW		
* Tolerance on three phase power is 208 V (+/- 5%), 60 Hz (+/- 3 Hz)			
** Tolerance on three phase power is 480 V (+/- 5%), 60 Hz (+/- 3 Hz)			

4.3 Pipe Connections



CAUTION: Risk of improper piping installation, leak checking, fluid chemistry and fluid maintenance. Can cause injury. Building and equipment damage may also result. Installation and service of this equipment should be done only by qualified personnel who have been specially-trained in the installation of air-conditioning equipment and who are wearing appropriate, OSHA-approved PPE.

NOTICE

Risk of piping-system corrosion and freezing fluids. Can cause leaks resulting in equipment and very expensive building damage. Heat exchangers and piping systems are at high risk of freezing and premature corrosion. Fluids in these systems must contain the proper antifreeze and inhibitors to prevent freezing and premature coil and piping corrosion. When the cooling unit or piping may be exposed to freezing temperatures, charge the system with coolant fluid based on the coldest ambient design temperature. Automotive antifreeze is unacceptable and must NOT be used in any fluid system. Use only coolant fluid solution that meets the requirements of recommended industry practices. Do not use galvanized pipe.

The system coolant fluid must be analyzed by a competent fluid-treatment specialist before start up to establish the inhibitor and antifreeze solution requirement and evaluated at regularly scheduled intervals throughout the life of the system to determine the pattern of inhibitor depletion.

The fluid complexity and variants of required treatment programs make it extremely important to obtain the advice of a competent and experienced fluid-treatment specialist and follow a regularly scheduled coolant-fluid system-maintenance program.

Fluid chemistry varies greatly as do the required additives, called inhibitors, that reduce the corrosive effect of the fluids on the piping systems and components.

The chemistry of the coolant fluid used must be considered, because some sources may contain corrosive elements that reduce the effectiveness of the inhibited formulation. Sediment deposits prevent the formation of a protective oxide layer on the inside of the coolant system components and piping. The coolant fluid must be treated and circulating through the system continuously to prevent the buildup of deposits and/or growth of sulfate reducing bacteria. Proper inhibitor maintenance must be performed to prevent corrosion of the system. Consult fluid manufacturer for testing and maintenance of inhibitors.

Commercial-grade coolant fluid is generally less corrosive to the common metals of construction than water itself. It will, however, assume the corrosivity of the coolant fluid from which it is prepared and may become increasingly corrosive with use if not properly inhibited.

Vertiv recommends installing a monitored fluid-detection system that is wired to activate the automatic-closure of field-installed coolant-fluid supply and return shut-off valves to reduce the amount of coolant-fluid leakage and consequential equipment and building damage. The shut-off valves must be sized to close-off against the maximum coolant-fluid system pressure in case of a catastrophic fluid leak.

NOTICE

Risk of no-flow condition. Can cause equipment damage. Do not leave the water/coolant fluid-supply circuit in a no-flow condition. Idle fluid allows the collection of sediment that prevents the formation of a protective oxide layer on the inside of the tubes. Keep unit switched On and water/ coolant fluid-supply circuit system operating continuously. In multiple unit teams, allow standby units to enter the rotation automatically or schedule regular manual rotations.

NOTICE

Risk of leaking chilled water lines. Can cause equipment and building damage.

Lines and joints must be inspected regularly. Improper installation, application and service practices can result in water leakage from the unit. Water leakage can result in severe property damage and loss of critical data center equipment. Do not locate unit directly above any equipment that could sustain water damage.

Vertiv recommends installing monitored leak detection equipment for the unit and supply and return lines.

NOTICE

Risk of a catastrophic water circuit rupture. Can cause expensive building and equipment damage.

Install an overflow drain pan under the unit with a monitored leak detection system in the pan and shutoff valves in the supply and return water lines that automatically close if water is detected by the leak detection system. The shutoff valves should be spring return and must be rated for a close-off pressure that is the same as or higher than the supply water pressure. If it is not possible to install an overflow drain pan, then a monitored leak detection system should be installed in the base of the unit or under the unit to actuate the shutoff valves immediately on a leak detection signal.

The overflow drain pan should have a drain line connected to it that flows to a floor drain or maintenance sink in case of a shutoff valve or leak detection system malfunction.

Pipe connections for both Primary and Secondary circuits are made at the rear of the cabinet and can be either top or bottom exit according to how the unit has been specified.

4.4 Pressure Limitations

Primary (facility) circuit:	145 psi (10 Bar) max. working pressure
Secondary circuit:	43 or 87 psi (3 or 6 Bar) max. working pressure (depending on rating of pressure relief valve installed)

4.5 Primary (Facility) Circuit

To ensure responsive control of secondary supply temperature, the Vertiv™ Liebert® XDU must be supplied with the primary flow rate and temperature appropriate to the heat load and level of glycol, as determined from **Figure 4.1** on the next page and **Figure 4.2** on page 29 .

Excess primary flow reduces the effective range of movement of the control valve, potentially restricting fine control, and possibly leading to instability of the secondary supply temperature. An external means of restricting or by-passing excessive primary flow should be available in the external pipework.

Figure 4.1 below illustrates the maximum primary circuit pressure drop through the Liebert® XDU450, with and without filtration, for plain water and water with 20% Propylene Glycol. See **Figure 4.1** below or [Graphs](#) on page 41 .

Figure 4.1 Primary Circuit Pressure Drop Graph

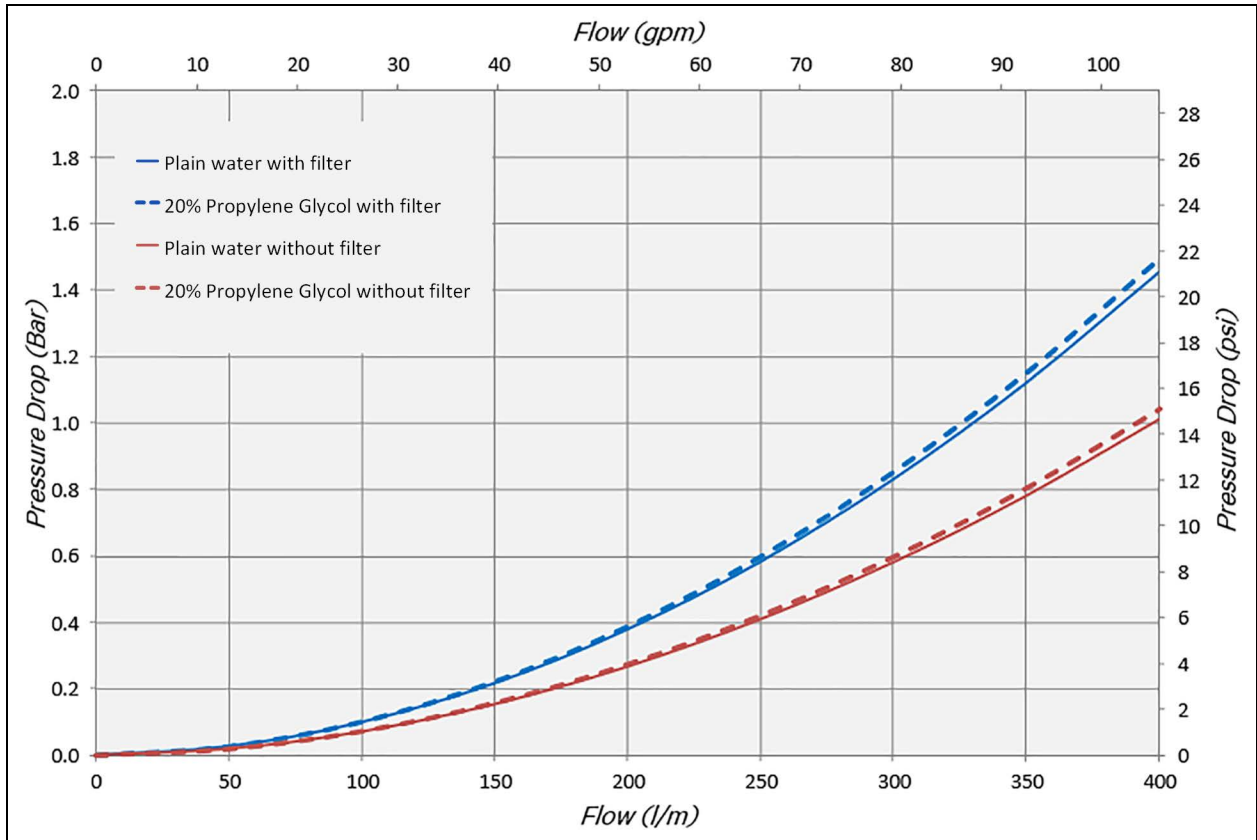

Figure 4.2 on the facing page, Figure 4.3 on page 30, and Figure 4.4 on page 31 are a guide for the primary (facility) water flow, based on required heat transfer at 5.4, 9.0, and 12.6 °F (3, 5, and 7 °C) approach temperature differences (ATD), for a variety of primary inlet temps (including Ashrae conditions). See Figure 4.3 on page 30 for example at 9 °F (5 °C) ATD.

Figure 4.2 Primary Flow/Temperature Graph for 5.4°F (3°C) ATD

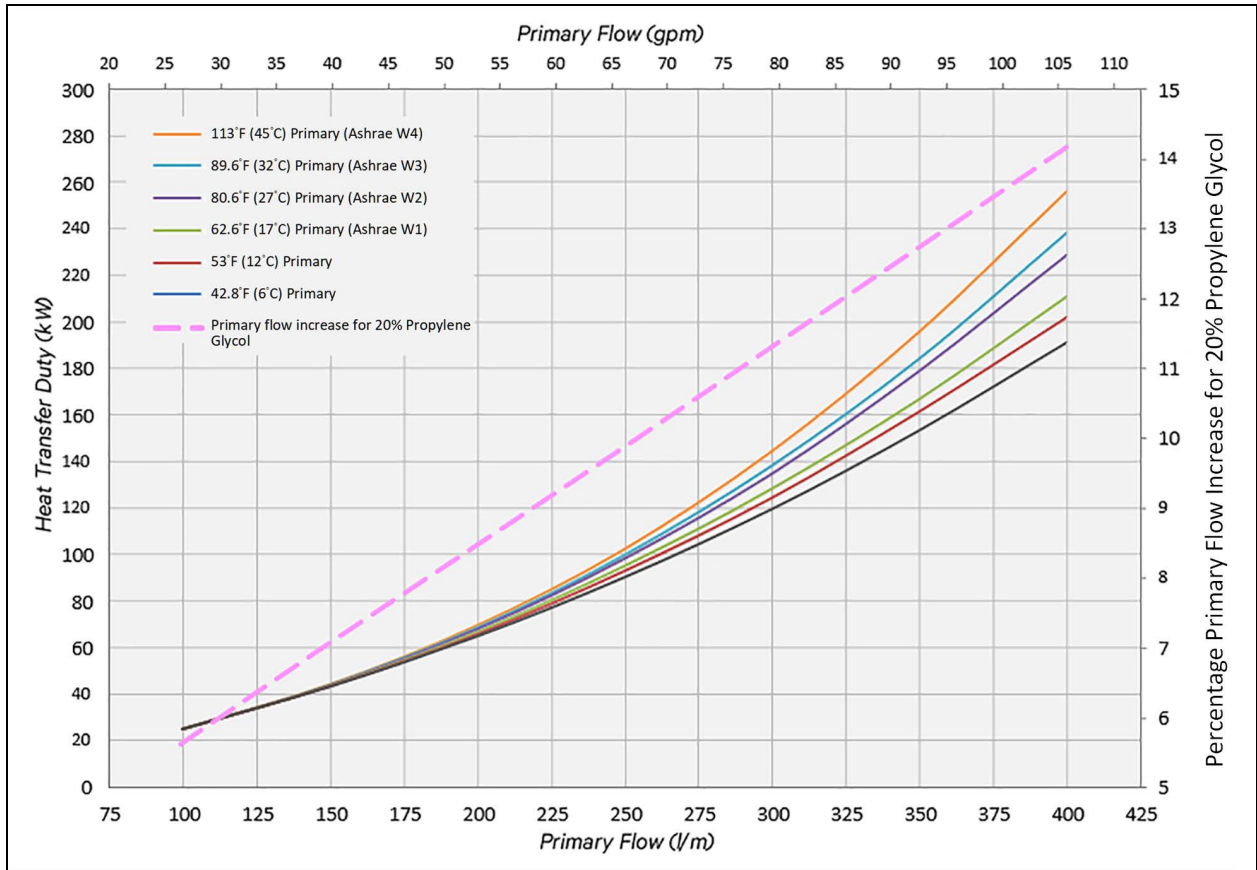
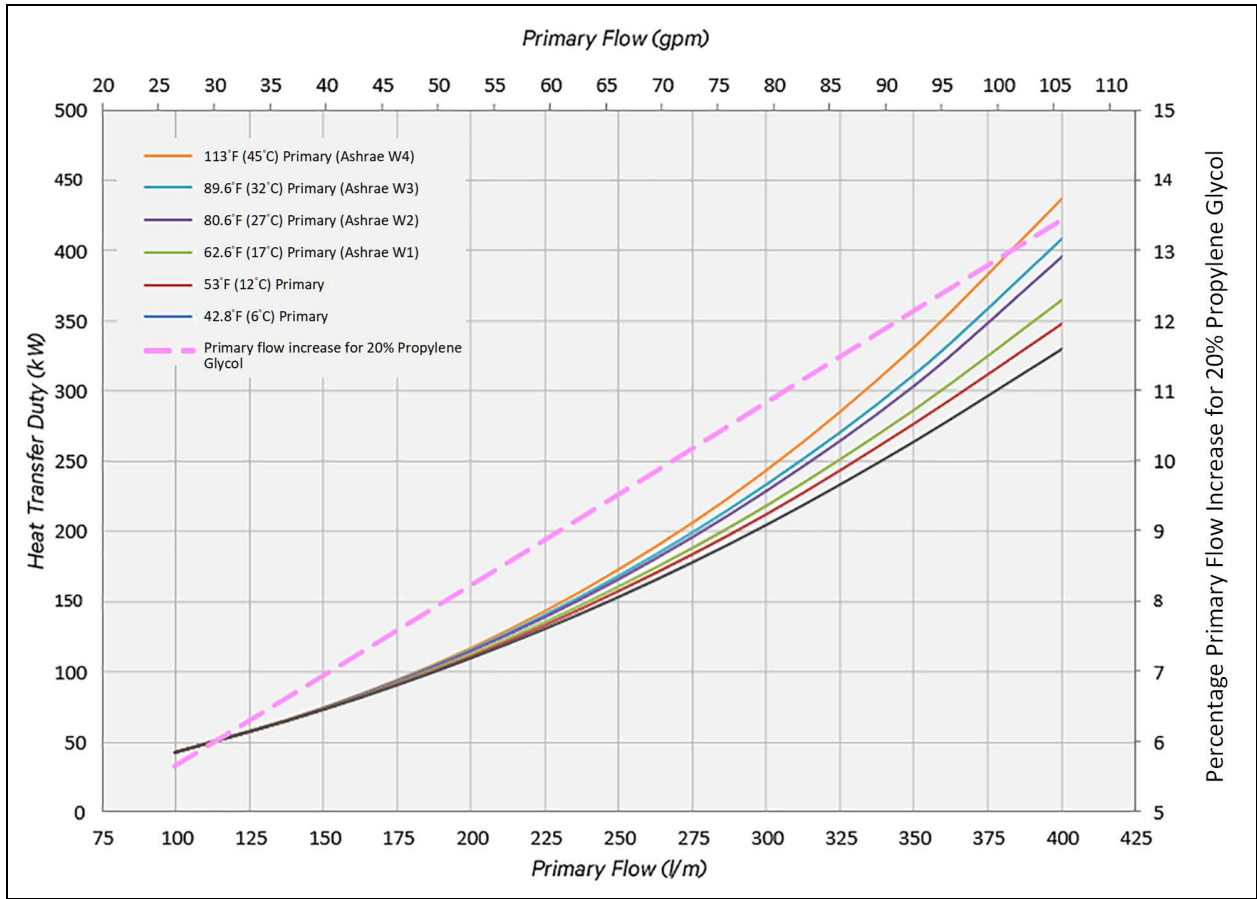
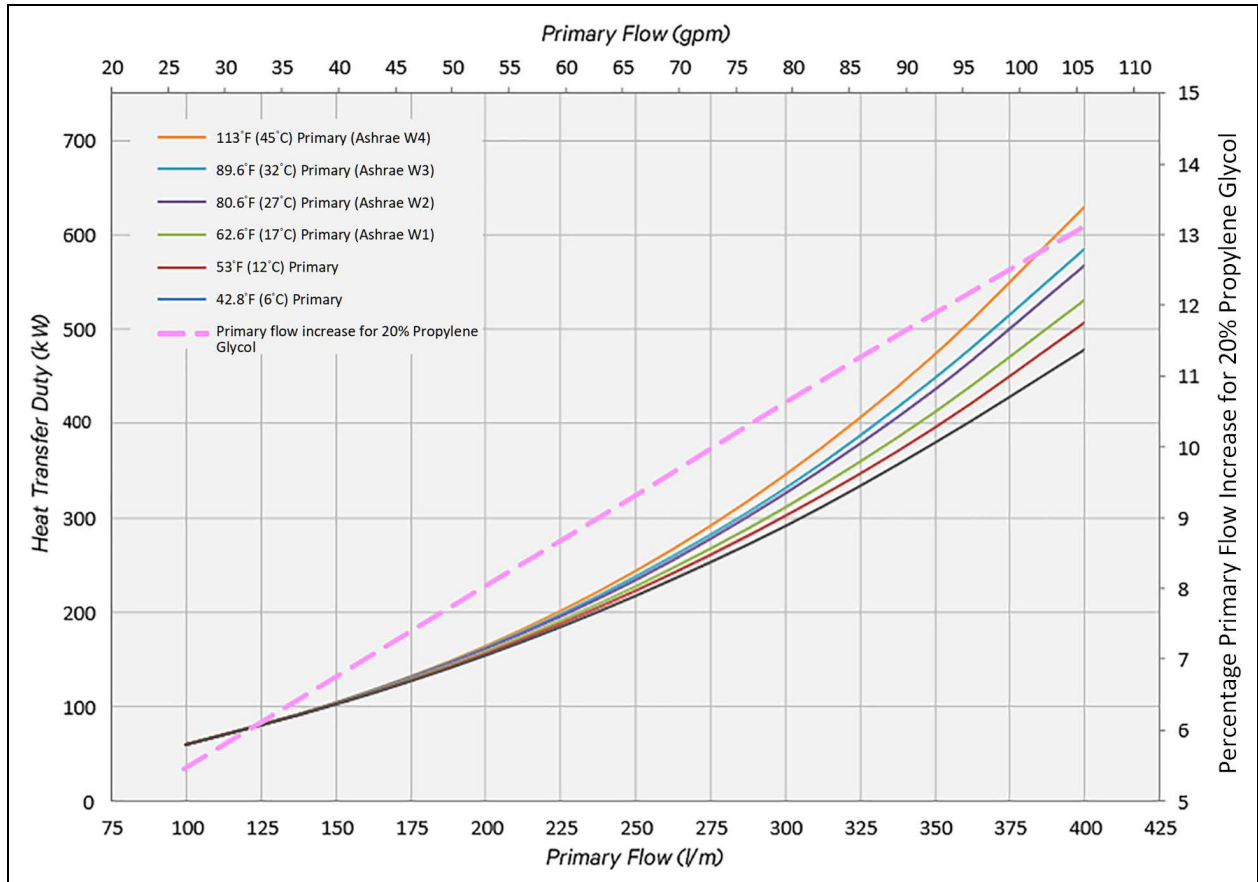

Figure 4.3 Primary Flow/Temperature Graph for 9°F (5°C) ATD



Example: If the required heat transfer (IT load) is 300 kW and the primary facility water temperature is 62.6 °F (17 °C) - so for a 9 °F (5 °C) ATD = a minimum secondary setpoint of 71.6 °F (22 °C), then the minimum required primary flow will be 94.8 gpm (359 l/m). If primary water contains 20% Propylene Glycol, then the 94.8 gpm (359 l/m) flow will need to be increased by 12.4% to 106.7 gpm (404 l/m) for the same 300 kW duty (dashed red arrows in **Figure 4.3** above).

Figure 4.4 Primary Flow/Temperature Graph for 12.6°F (7°C) ATD

**NOTE:**

1. All three Primary Flow/Temperature graphs shown are assuming nominal secondary flow rate of 105.7 gpm (400 l/m). If 25% Propylene Glycol is the preferred fluid, then some loss in heat transfer performance can be expected (see Note 4).
2. For stable control, the primary fluid flow should not be more than 20% above the values illustrated.
3. Minimum secondary supply temperature (i.e. secondary set point) will be the primary facility water temperature plus the ATD (approach temperature difference).
4. Absolute heat transfer performance for specific flow and temperature conditions, or for specific fluids can be calculated by the manufacturer if required (see [Technical Support and Contacts](#) on page 37).

The Vertiv™ Liebert® XDU450 can be specified with a factory fitted primary filter (screen size of 500 microns/35 mesh) – refer to [Vertiv™ Liebert® XDU450 Model Number Nomenclature](#) on page 12 for configuration options. If this option is not specified, then alternative arrangements should be made for a similar level of filtration to be provided at point of installation.

The Primary circuit of the Liebert® XDU450 is rated for a max. working pressure of 145 psi (10 bar). If the pressure at installation exceeds this, then arrangements should be made to fit a pressure reducing valve.

NOTE: Both Primary inlet and return connections should be fitted with full port isolation valves at point of installation, for maintenance purposes.

4.6 Secondary Circuit

Secondary pipework components must be clean and free of debris and organic matter. Clean water must be used in assembly operations, and any residual water blown out and the pipework dried before filling with the secondary fluid to be used.

If load banks are to be used in commissioning and site-acceptance tests, the load banks must be clean and free of debris and organic matter. The fluid circuit can be protected by use of:

- a. A filter appropriate to the intended use (refer to the ITE cooling system manufacturer for further advice) and no coarser than 50µ if the CDU is fitted with secondary filters and 500µ if the CDU is not fitted with secondary filters.
- b. A heat exchanger to separate the load bank circuit from the secondary pipework

Threaded joints must not be sealed with polytetrafluoroethylene tape as particles from the tape may enter the fluid stream and cause clogging. Instead, a thread sealant must be used to seal threaded fittings.

Overhead secondary field piping should be fitted by the installer with high point air vents to remove air during filing and commissioning. These maybe manual or automatic style vents. Automatic vents should not be placed in lines overhead of cabinets containing sensitive electronics or other electrical equipment.

Figure 4.5 below shows the flow/pressure differential available at the secondary supply and return connections of the Vertiv™ Liebert® XDU450 (manifold QCs have not been allowed for).

Figure 4.5 Available Secondary External Differential Pressure

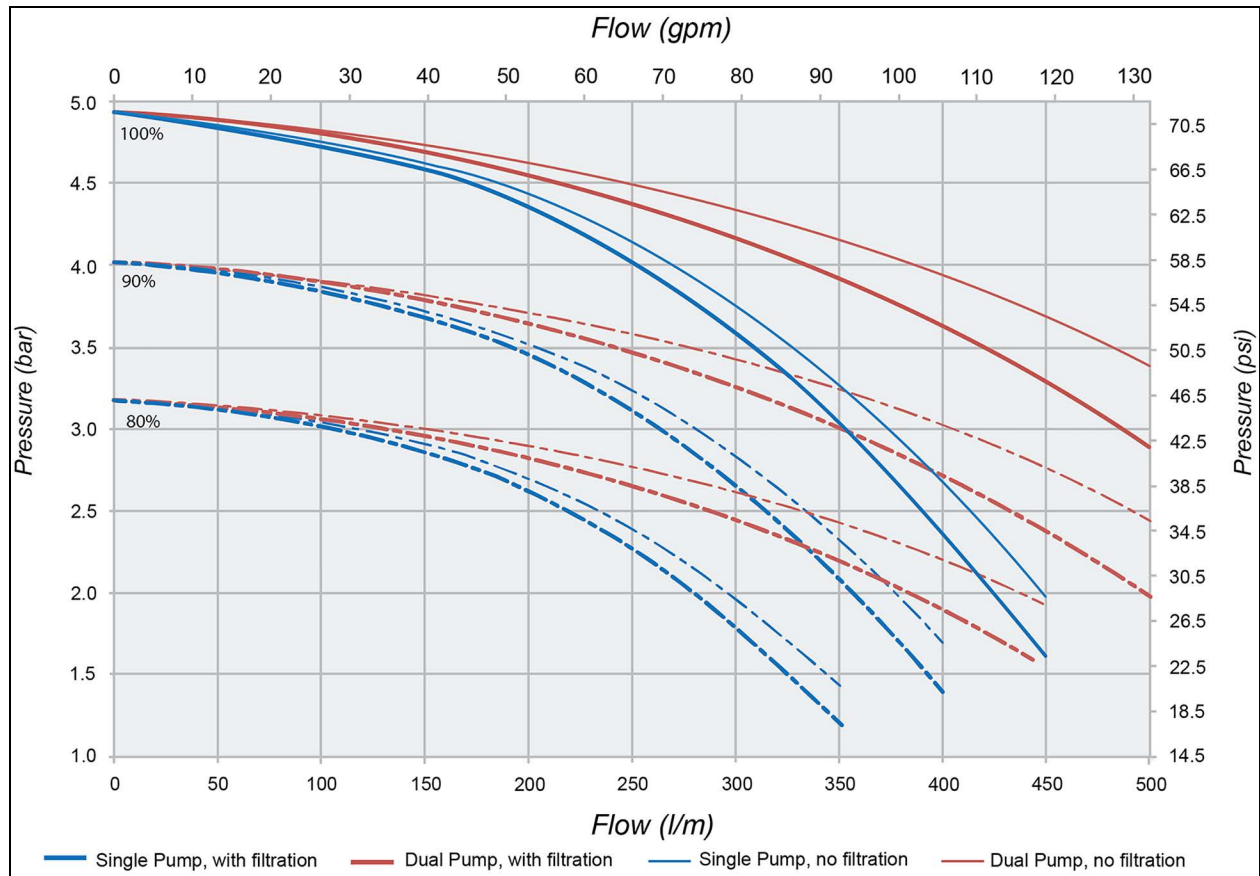
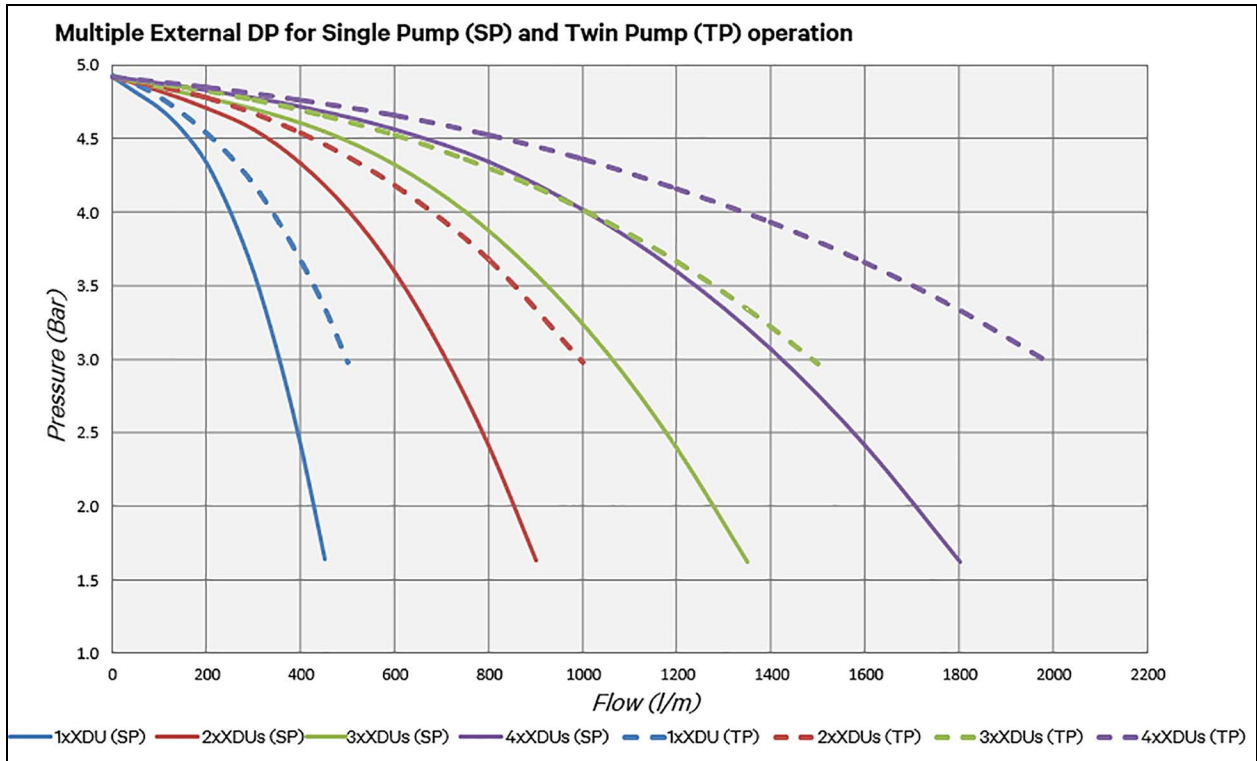

Figure 4.6 Flow/Pressure Graphs for Multiple Units (pumps) in Parallel



NOTE: Both Secondary inlet and return connections should be fitted with full bore isolation valves at point of installation, for maintenance purposes.

4.7 Wetted Materials

For fluid compatibility purposes, all component materials in both Primary and Secondary circuits are listed below:

Table 4.3 Primary Facility Circuit Connections

Component	Materials
Hygienic fittings	316 Stainless Steel, EPDM seals
Butterfly hygienic valves	316 Stainless Steel, EPDM seals
Pipe work	304 Stainless Steel (316 optional)
Machined pipe fittings	304 Stainless Steel (316 optional)
3-way cooling valve	Brass DZR (body), Stainless steel (ball and stem), with PTFE seats and EPDM (O-ring seals)
Plate heat exchanger	304 Stainless Steel, copper brazed (316 optional)
Schrader valves	Brass (body), Stainless Steel (valve insert)
Pressure sensors	17-4PH (630) Stainless Steel

Table 4.3 Primary Facility Circuit Connections (continued)

Component	Materials
Flow meter	316 Stainless Steel, 316 (compression fitting)
Filter	304 and 316 Stainless steel, EPDM (O-ring seals)
Drain valves	Nickel plated brass, Nylon 6, EPDM (O-ring seal)

Table 4.4 Secondary Circuit Connections

Component	Materials
Hygienic fittings	316 Stainless steel, EPDM seals
Butterfly hygienic valves	316 Stainless steel, EPDM seals
Pipe work	304 Stainless steel (316 optional)
Machined pipe fittings	304 Stainless steel (316 optional)
Main pump(s)	316 Stainless steel, EPDM (O-ring seals)
Insert non-return valve	Acetal (body and valve), EPDM (O-ring seals), Stainless steel (spring)
Fill pump	EPDM (diaphragm), polyamide body
Plate heat exchanger	304 Stainless steel, copper brazed (316 optional)
Schrader valves	Brass (body), Stainless Steel (valve insert)
Pressure sensors	17-4PH (630) Stainless Steel
Flow meter	316 Stainless Steel, 316 (compression fitting)
Filter	304 and 316 Stainless steel, EPDM (O-ring seals)
Drain valves	Nickel plated brass, Nylon 6, EPDM (O-ring seal)
Automatic air vent	Brass (body), Stainless steel (spring), Expanded polythene (float), Polyacetal (vacuum breaker), Polyphenylene oxide (leaver, cap), NBR (seals)
Pressure Relief Valve	Brass (body), Ni-Cr (spring), EPDM (seal)
Expansion vessel	304 Stainless steel (connector), Butyl (membrane)
Exp. Vessel hose	EPDM (hose), chrome plated brass (connections)
Fill quick coupler and hose	Acetal (body), Buna-N (seal), 316 Stainless Steel (spring), PVC (hose), Brass (hose tail),
Fill non-return valve	Brass chrome plated (shell), Acetal (body and valve), EPDM (O-ring seals), Stainless steel (spring)
Push-fit fittings (fill hose)	Nickel Plated Brass (body), NBR (seal), Stainless Steel (tube grip)
Optical level sensor	Polysulfone (body), Viton (O-ring seal)

5 Communications

5.1 Group Control

Groups of Vertiv™ Liebert® XDU450 units can be networked using a twisted pair of CANbus wires in order to provide coordinated control in larger installations and N+X redundancy.

Figure 5.1 Liebert® XDU450 Group Control (max number of units in a single group is 8)

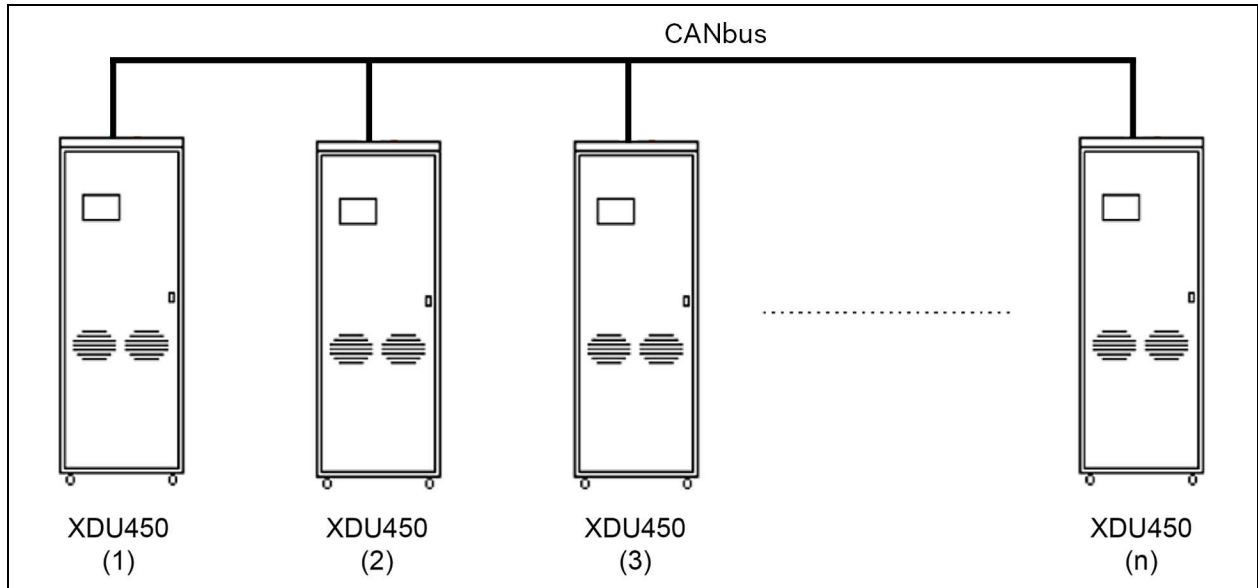

Once each Liebert® XDU450 has been assigned a unique address, the system becomes self-organizing. One Liebert® XDU450 automatically assumes the role of the master and as such coordinates the running state of the other units based on the configured level of redundancy, the system pressure requirements and any alarm conditions.

Changes to the group settings (e.g., number of run units) or system settings (e.g. DP setpoint) can be made via any Liebert® XDU450 touchscreen user-interface at any time and will result in changes to all units of the connected network.

5.2 Remote Monitoring and Control

The Vertiv™ Liebert® XDU450 provides a RS-485 and 2 off 10/100 Ethernet communication ports for external and remote monitoring and control via customer BMS and/or DCIM and/or super computer control nodes. BACnet can be provided as an option for external and remote monitoring and control.

RS-485 Port

MODBUS RTU is supported.

Refer to [Modbus Register Table](#) on page 47 for further details.

10/100 Ethernet Ports

Each port can be configured with its own IP address or both ports can share a single IP address for failover operation in 1+1 LANs (A and B switches). See the Operation and Maintenance Manual.

Standard TCP/IPv4 application protocols and services are supported, including

- SNMPv2/3 (Simple Network Management Protocol)
- HTTP (Web Server)
- FTP (File Server)

BACnet

Optional BACnet gateway support

- BACnet IP – Ethernet 10/100
- BACnet MSTP -RS485

Refer to [Vertiv™ Liebert® XDU450 BACnet Points List](#) on page 53 for further details.

Appendices

Appendix A: Technical Support and Contacts

A.1 Technical Support/Service in the United States

Vertiv Group Corporation

24x7 dispatch of technicians for all products.

1-800-543-2378

Liebert® Thermal Management Products

1-800-543-2778

Liebert® Channel Products

1-800-222-5877

Liebert® AC and DC Power Products

1-800-543-2378

A.2 Locations

United States

Vertiv Headquarters

1050 Dearborn Drive

Columbus, OH, 43085, USA

Europe

Via Leonardo Da Vinci 8 Zona Industriale Tognana

35028 Piove Di Sacco (PD) Italy

Asia

7/F, Dah Sing Financial Center

3108 Gloucester Road, Wanchai

Hong Kong

This page intentionally left blank

Appendix B: Pipe Schematic Vertiv™ Liebert® XDU450

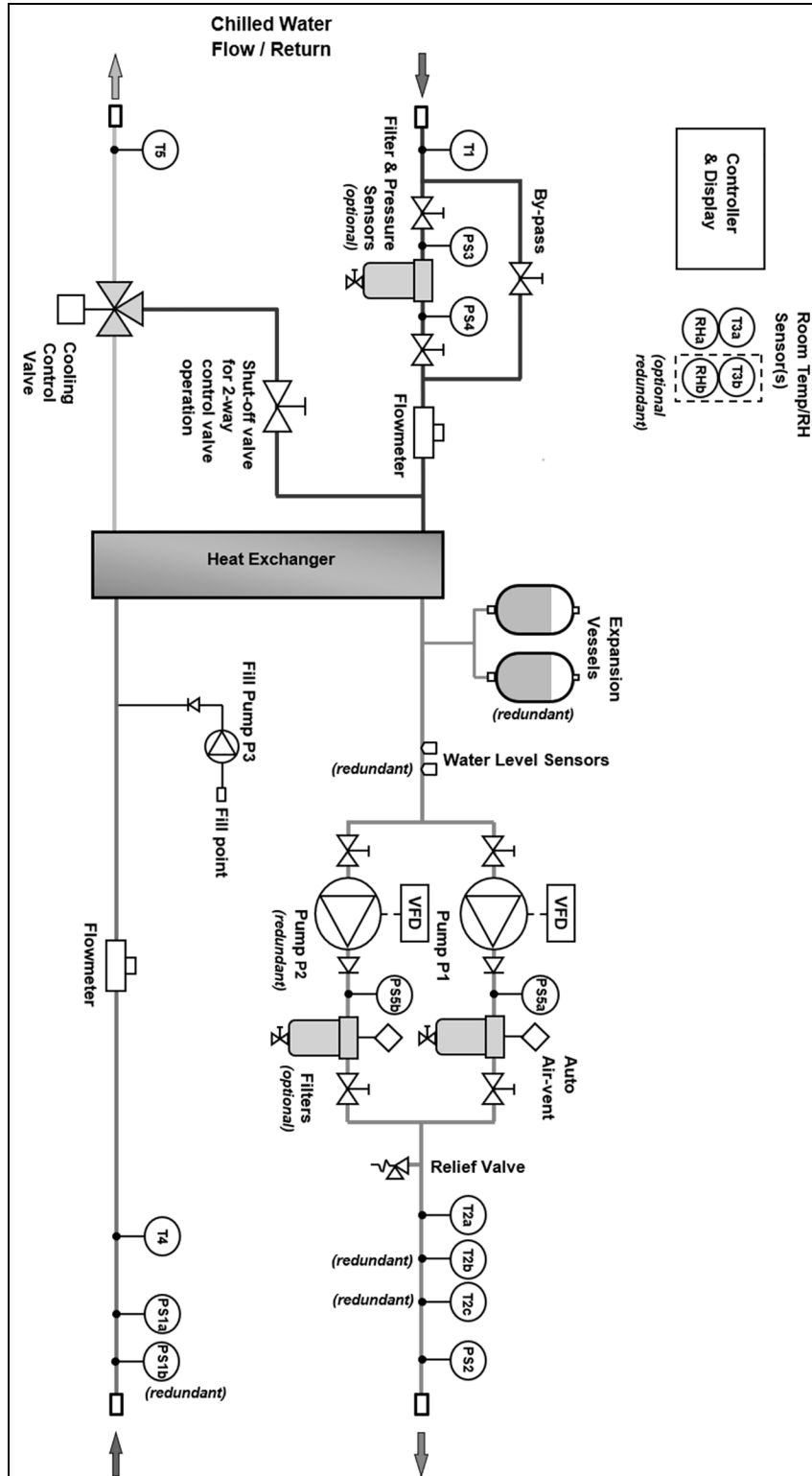

This page intentionally left blank

Appendix C: Graphs

Figure C.1 Primary Circuit Pressure Drop Graph

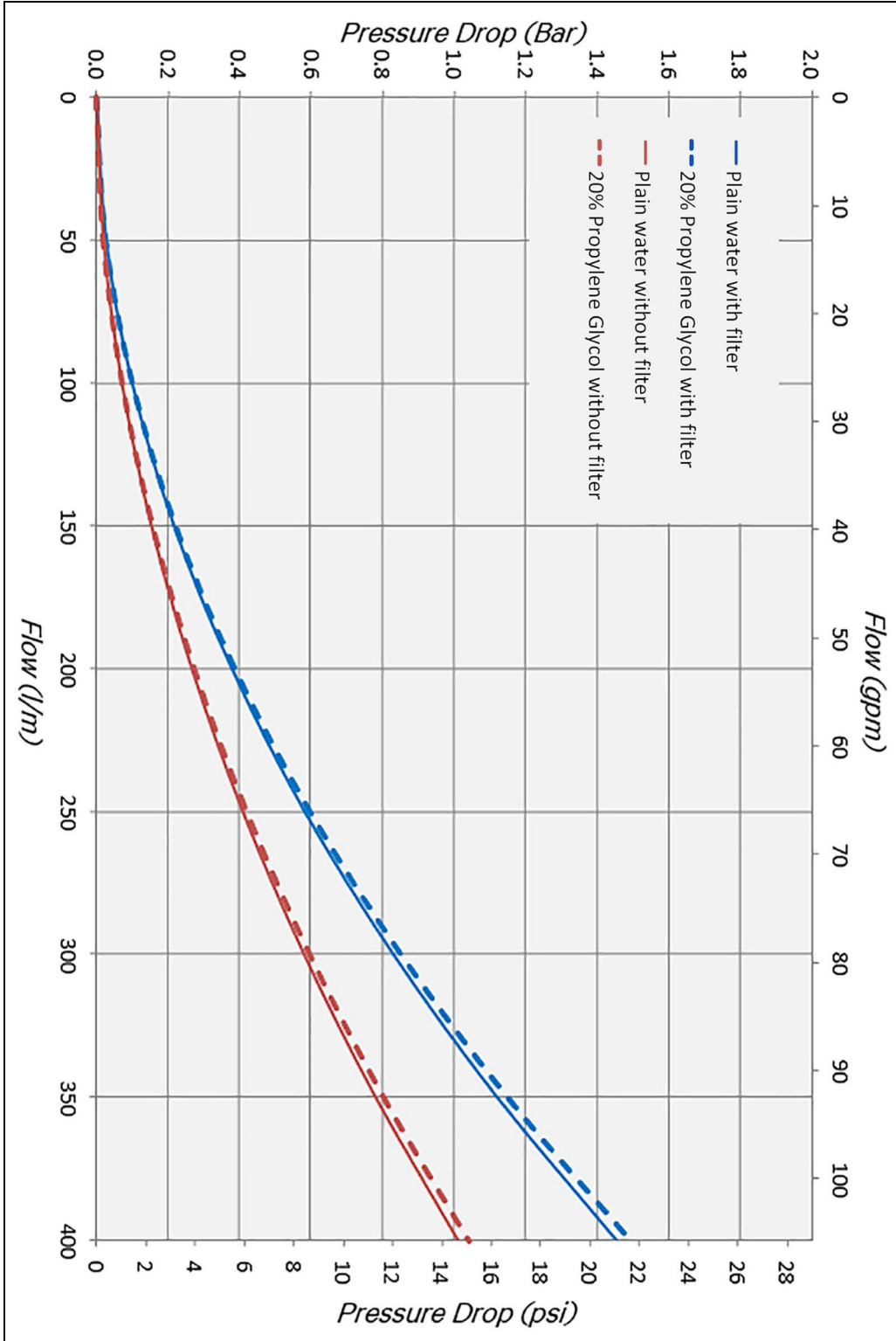

Figure C.2 Primary Flow/Temperature Graph for 5.4°F (3°C) ATD

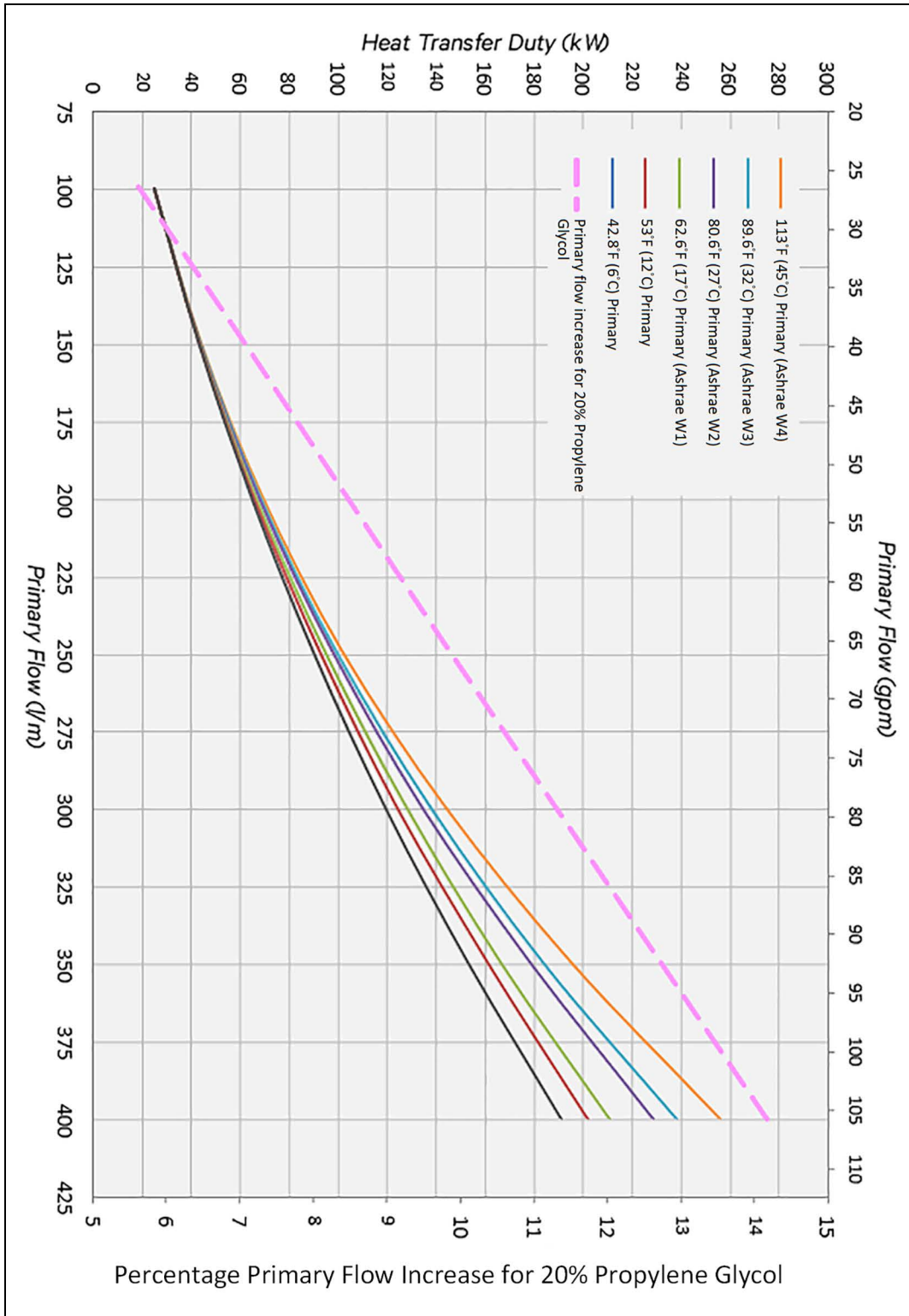

Figure C.3 Primary Flow/Temperature Graph for 9°F (5°C) ATD

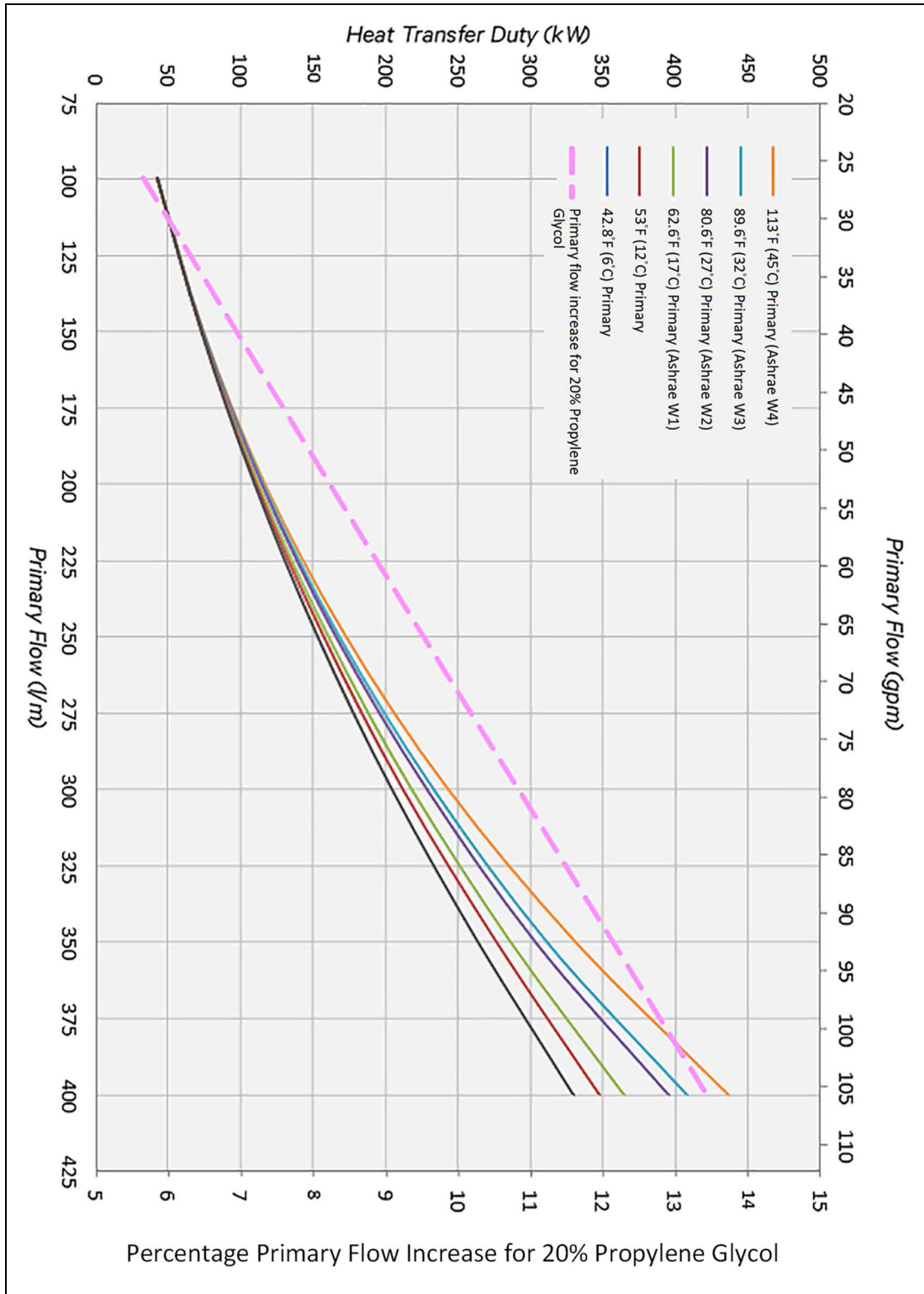

Figure C.4 Primary Flow/Temperature Graph for 12.6°F (7°C) ATD

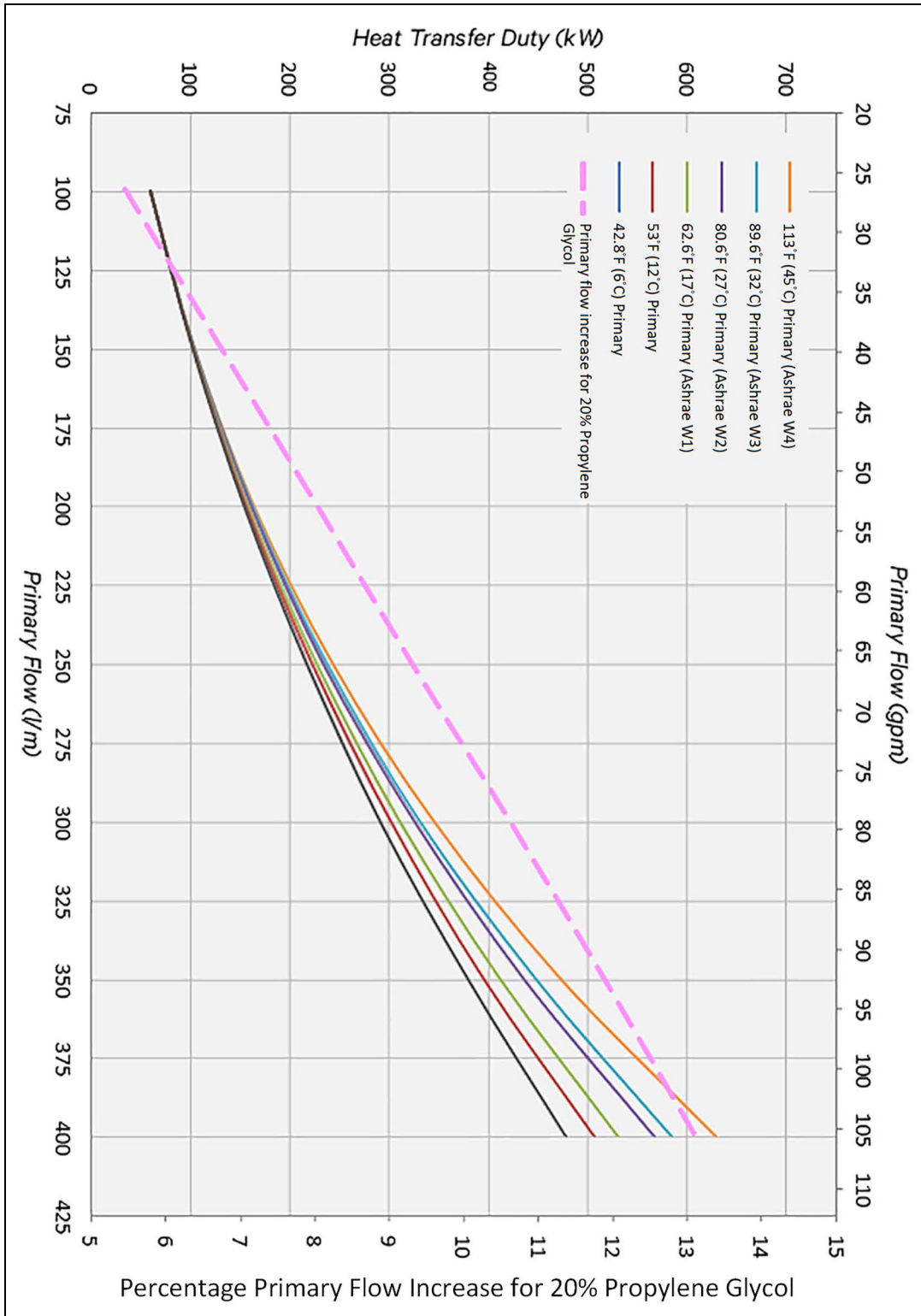

Figure C.5 Available Secondary External Differential Pressure

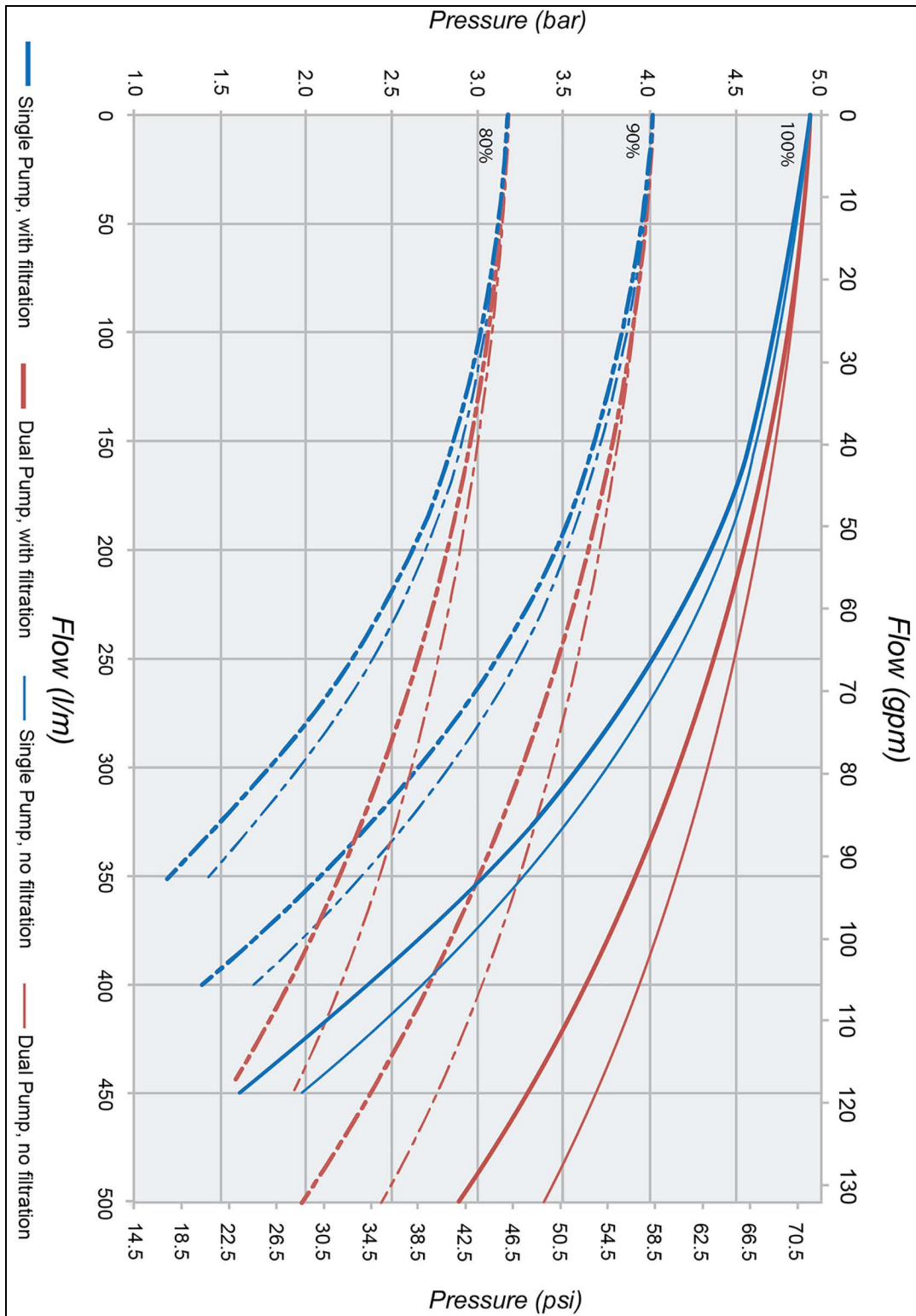
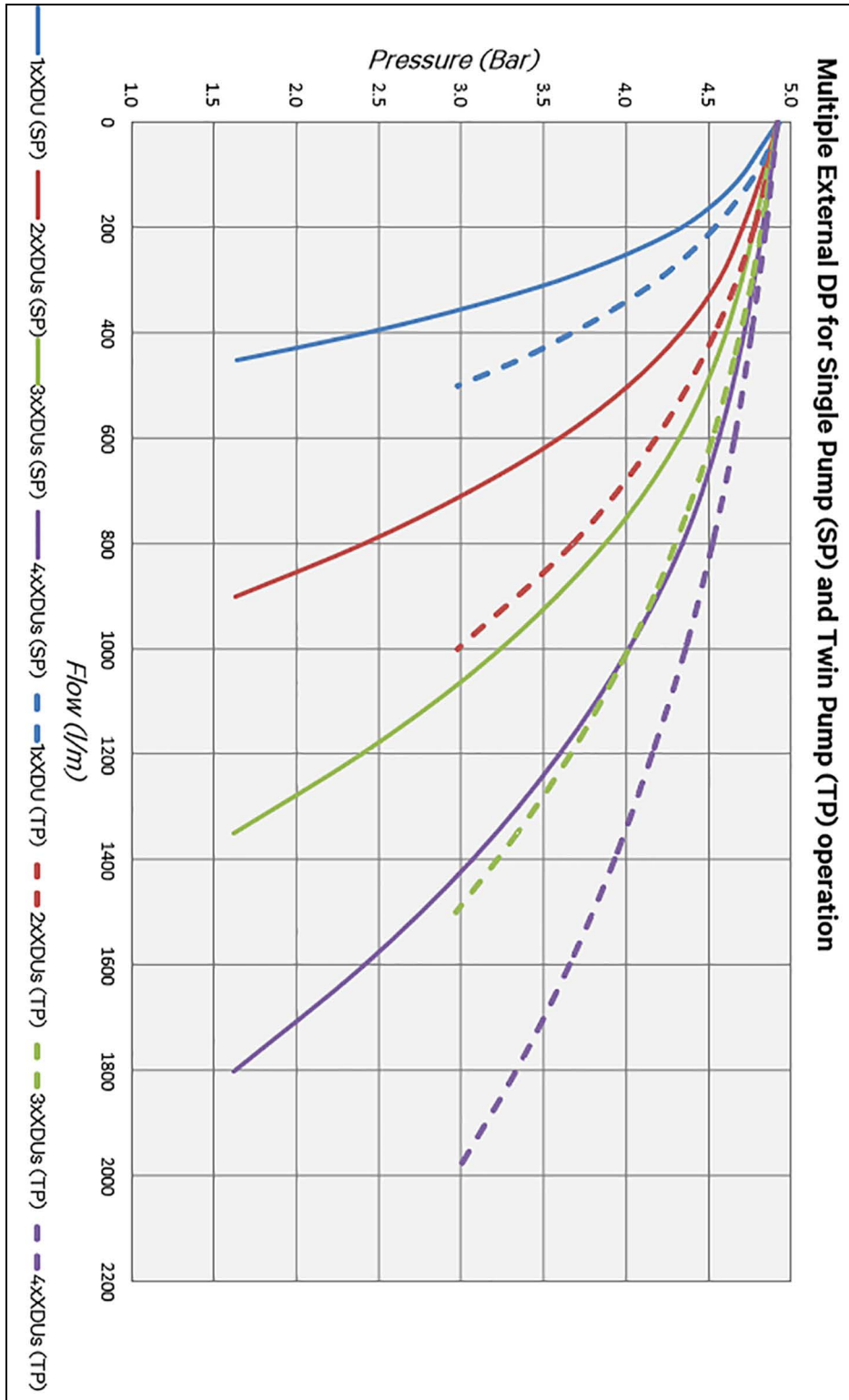

Figure C.6 Flow/Pressure Graphs for Multiple Units (pumps) in Parallel



Appendix D: Modbus Register Table

Table D.1 Discrete Inputs

Register Number	Register Description	Liebert® XDU450 Alarm Code
Register Number	Register Description	
1	Critical Alarm (0 = Inactive, 1 = Active)	-
2	Non-Critical Alarm (0 = Inactive, 1 = Active)	-
3	Alarm : T1 Temperature Sensor Fault	A01
4	Alarm : T2a Temperature Sensor Fault	A02
5	Alarm : T2b Temperature Sensor Fault	A03
6	Alarm : T2c Temperature Sensor Fault	A04
7	Alarm : T3a Temperature Sensor Fault	A05
8	Alarm : T3b Temperature Sensor Fault	A06
9	Alarm : T4 Temperature Sensor Fault	A07
10	Alarm : RHa Relative Humidity Sensor Fault	A08
11	Alarm : RHb Relative Humidity Sensor Fault	A09
12	Alarm : PS1a Pressure Sensor Fault	A10
13	Alarm : PS1b Pressure Sensor Fault	A11
14	Alarm : PS2 Pressure Sensor Fault	A12
15	Alarm : PS3 Pressure Sensor Fault	A13
16	Alarm : PS4 Pressure Sensor Fault	A14
17	Alarm : PS5a Pressure Sensor Fault	A15
18	Alarm : PS5b Pressure Sensor Fault	A16
19	Alarm : Secondary Flow Meter Sensor Fault	A17
20	Alarm : Primary Flow Meter Sensor Fault	A18
21	Alarm : microSD Card Fault	A19
22	Alarm : Leak Fault / Water make-up empty	A20
23	Alarm : Leak Shutdown / Insufficient Water Level	A21
24	Alarm : P1 Inverter Fault	A22
25	Alarm : P1 Inverter Low Flow	A23
26	Alarm : P2 Inverter Fault	A24
27	Alarm : P2 Inverter Low Flow	A25
28	Alarm : Sec Pump Flow Shutdown	A26
29	Alarm : Valve Fault	A27
30	Alarm : Primary Water Low Flow	A28

Table D.1 Discrete Inputs (continued)

Register Number	Register Description	Liebert® XDU450 Alarm Code
31	Alarm : Primary Filter Dirty	A29
32	Alarm : Primary Water Low Temp	A30
33	Alarm : Primary Water High Temp	A31
34	Alarm : Secondary Water Low Temp	A32
35	Alarm : Secondary Water High Temp	A33
36	Alarm : Flood 1 Unit	A34
37	Alarm : Sec Temp Diff Out Of Limits	A35
38	Alarm : Sec Over Pressure	A36
39	Alarm : Flood Under floor	A37
40	Alarm : Check Water Make-up Level	A38
41	Alarm : System Low Pressure	A39
42	Alarm : Secondary Over-pressure	A40
43	Alarm : Primary Water No Flow	A41
44	Alarm : Level Sensor – No Water Detected	A42
45	Alarm : Illegal Water Sensor Condition	A43
46	Alarm : Group Control Network Fault	A44
47	Alarm : Inverter 1 Communications Error	A45
49	Alarm : Inverter 2 Communications Error	A46
50	Alarm : Secondary Filter 1 Dirty	A47
51	Alarm : Secondary Filter 2 Dirty	A48
52	Alarm : Secondary Temperature T2a Diff Fault	A49
53	Alarm : Secondary Temperature T2b Diff Fault	A50
54	Alarm : Secondary Temperature T2c Diff Fault	A51
55	Alarm : Group Control Insufficient Units Available	A52
56	Alarm : Restricted Pump Performance	A53
57	Alarm : T5 Temperature Sensor Fault	A54

Access to the Discrete Inputs table is provided by MODBUS function code 02 – Read Input Status.

For all discrete input registers which contain an alarm status, a value of 1 indicates the presence of the alarm condition, while a value of 0 indicates the healthy (no alarm) condition.

Table D.2 Input Registers

Register Number	Description	Units	Scaling	Data Type
1	Mode 0 = not configured, 1 = shutdown – remote start/stop, 2 = shutdown - network, 3 = full manual control 4 = standby 5 = online (running) 6 = online (filling) 7 = filling 8 = shutdown – fault 9 = group standby	n/a	1	Unsigned
2	Group Control Mode 0 = standalone 1 = primary 2 = secondary 3 = independent (due to network fault)	n/a	1	Unsigned
3	Current Pump 0 = pump 1 and 2 1 = pump 1 2 = pump 2	n/a	1	Unsigned
4	Pump 1 Speed	%	1	Unsigned
5	Pump 2 Speed	%	1	Unsigned
6	Control Valve (Cooling) Demand	%	1	Unsigned
7	Control Valve Feedback	%	1	Unsigned
8	Primary Supply Temperature T1	°C	0.1	Signed
9	Secondary Supply Temperature T2a	°C	0.1	Signed
10	Secondary Supply Temperature T2b	°C	0.1	Signed
11	Secondary Supply Temperature T2c	°C	0.1	Signed
12	Secondary Supply Temperature T2	°C	0.1	Signed
13	Room Temperature T3a	°C	0.1	Signed
14	Room Relative Humidity RHa	% RH	0.1	Unsigned
15	Dew Point DWa	°C	0.1	Signed
16	Room Temperature T3b	°C	0.1	Signed
17	Room Relative Humidity RHb	% RH	0.1	Unsigned
18	Dew Point DWb	°C	0.1	Signed

Table D.2 Input Registers (continued)

Register Number	Description	Units	Scaling	Data Type
19	Secondary Return Temperature T4	°C	0.1	Signed
20	Secondary Return Pressure PS1a	Bar	0.01	Signed
21	Secondary Return Pressure PS1b	Bar	0.01	Signed
22	Secondary Return Pressure PS1	Bar	0.01	Signed
23	Secondary Supply Pressure PS2	Bar	0.01	Signed
24	Secondary Differential Pressure (PS2 – PS1)	Bar	0.01	Signed
25	Primary Filter Inlet Pressure PS3	Bar	0.01	Signed
26	Primary Filter Outlet Pressure PS4	Bar	0.01	Signed
27	Primary Filter Differential Pressure (PS3 – PS4)	Bar	0.01	Signed
28	Primary Flow Rate	L/m	1	Unsigned
29	Secondary Flow Rate	L/m	1	Unsigned
30	Secondary Duty	kW	1	Unsigned
31	Temperature Setpoint	°C	0.1	Signed
32	Pump P1 Runtime	Hours	1	Unsigned
33	Pump P2 Runtime	Hours	1	Unsigned
34	Secondary Filter 1 Inlet Pressure PS5a	Bar	0.01	Signed
35	Secondary Filter 2 Inlet Pressure PS5b	Bar	0.01	Signed
36	Secondary Filter 1 Differential Pressure (PS5a – PS2)	Bar	0.01	Signed
37	Secondary Filter 2 Differential Pressure (PS5b – PS2)	Bar	0.01	Signed
38	Controller Software Version Number Format is x.yy where x = major version number, yy = minor version number	n/a	0.01	Unsigned
39	Controller Up-time	Mins	1	Unsigned
40	System (Group) Average Secondary Differential Pressure	Bar	0.01	Signed
41	System (Group) Total Secondary Flow Rate	L/m	1	Unsigned
42	Primary Return Temperature T5	°C	0.1	Signed
43	Primary Duty	kW	1	Unsigned

Access to the Input Register table is provided by MODBUS function code 04 – Read Input Registers.

Table D.3 Coils

Register Number	Description
1	Remote Shutdown To switch on the CDU write OFF. To switch off the CDU write ON.

Read access to the Coil table is provided by MODBUS function code 01 – Read Coil Status.

Write Access to the Coil table is provided by MODBUS function code 05 – Write Single Coil.

This page intentionally left blank

Appendix E: Vertiv™ Liebert® XDU450 BACnet Points List

Name	Type	Instance
Comm Error Device 0	3: BI	0
Alarm	5: BV	1
Alarm A01: T1 Temperature Sensor Fault	5: BV	2
Alarm A02: T2a Temperature Sensor Fault	5: BV	3
Alarm A03: T2b Temperature Sensor Fault	5: BV	4
Alarm A04: T2c Temperature Sensor Fault	5: BV	5
Alarm A05: T3a Temperature Sensor Fault	5: BV	6
Alarm A06: T3b Temperature Sensor Fault	5: BV	7
Alarm A07: T4 Temperature Sensor Fault	5: BV	8
Alarm A08: RHa Relative Humidity Sensor Fault	5: BV	9
Alarm A09: RHb Relative Humidity Sensor Fault	5: BV	10
Alarm A10: PS1a Pressure Sensor Fault	5: BV	11
Alarm A11: PS1b Pressure Sensor Fault	5: BV	12
Alarm A12: PS2 Pressure Sensor Fault	5: BV	13
Alarm A13: PS3 Pressure Sensor Fault	5: BV	14
Alarm A14: PS4 Pressure Sensor Fault	5: BV	15
Alarm A15: PS5a Pressure Sensor Fault	5: BV	16
Alarm A16: PS5b Pressure Sensor Fault	5: BV	17
Alarm A17: Secondary Flow Meter Sensor Fault	5: BV	18
Alarm A18: Primary Flow Meter Sensor Fault	5: BV	19
Alarm A19: microSD Card Fault	5: BV	20
Alarm A20: Leak Fault / Water make-up empty	5: BV	21
Alarm A21: Leak Shutdown / Insufficient Water Level	5: BV	22
Alarm A22: P1 Inverter Fault	5: BV	23
Alarm A23: P1 Inverter Low Flow	5: BV	24
Alarm A24: P2 Inverter Fault	5: BV	25
Alarm A25: P2 Inverter Low Flow	5: BV	26
Alarm A26: Sec Pump Flow Shutdown	5: BV	27
Alarm A27: Valve Fault	5: BV	28
Alarm A28: Primary Water Low Flow	5: BV	29
Alarm A29: Primary Filter Dirty	5: BV	30
Alarm A30: Primary Water Low Temp	5: BV	31

Name	Type	Instance
Alarm A31 : Primary Water High Temp	5: BV	32
Alarm A32 : Secondary Water Low Temp	5: BV	33
Alarm A33 : Secondary Water High Temp	5: BV	34
Alarm A34 : Flood 1 Unit	5: BV	35
Alarm A35 : Sec Temp Diff Out Of Limits	5: BV	36
Alarm A36 : Sec Over Pressure	5: BV	37
Alarm A37 : Flood Under floor	5: BV	38
Alarm A38 : Check Water Make-up Level	5: BV	39
Alarm A39 : System Low Pressure	5: BV	40
Alarm A40 : Secondary Over-pressure	5: BV	41
Alarm A41 : Primary Water No Flow	5: BV	42
Alarm A42 : Level Sensor – No Water Detected	5: BV	43
Alarm A43 : Illegal Water Sensor Condition	5: BV	44
Alarm A44 : Group Control Network Fault	5: BV	45
Alarm A45 : Inverter 1 Communications Error	5: BV	46
Alarm A46 : Inverter 2 Communications Error	5: BV	47
Alarm A47 : Secondary Filter 1 Dirty	5: BV	48
Alarm A48 : Secondary Filter 2 Dirty	5: BV	49
Alarm A49 : Secondary Temperature T2a Diff Fault	5: BV	50
Alarm A50 : Secondary Temperature T2b Diff Fault	5: BV	51
Alarm A51: Secondary Temperature T2c Diff Fault	5: BV	52
Alarm A52 : Group Control Insufficient Units Available	5: BV	53
Alarm A53 : Restricted Pump Performance	5: BV	54
Alarm A54 : T5 Temperature Sensor Fault	5: BV	55
Alarm A55 : Pump 1 Fault	5: BV	56
Alarm A56 : Pump 2 Fault	5: BV	57
Mode	2: AV	58
Group Control Mode	2: AV	59
Pump 1 Speed	2: AV	61
Pump 2 Speed	2: AV	62
Control Valve (Cooling) Demand	2: AV	63
Control Valve Feedback	2: AV	64
Primary Supply Temperature T1	2: AV	65
Secondary Supply Temperature T2a	2: AV	66

Name	Type	Instance
Secondary Supply Temperature T2b	2: AV	67
Secondary Supply Temperature T2c	2: AV	68
Secondary Supply Temperature T2	2: AV	69
Room Temperature T3a	2: AV	70
Room Relative Humidity Rha	2: AV	71
Dew Point DWa	2: AV	72
Secondary Return Temperature T4	2: AV	76
Secondary Return Pressure PS1a	2: AV	77
Secondary Return Pressure PS1b	2: AV	78
Secondary Return Pressure PS1	2: AV	79
Secondary Supply Pressure PS2	2: AV	80
Secondary Differential Pressure	2: AV	81
Primary Filter Inlet Pressure PS3	2: AV	82
Primary Filter Outlet Pressure PS4	2: AV	83
Primary Filter Differential Pressure (PS3 – PS4)	2: AV	84
Primary Flow Rate	2: AV	85
Secondary Flow Rate	2: AV	86
Secondary Duty	2: AV	87
Temperature Setpoint	2: AV	88
Pump P1 Runtime	2: AV	89
Pump P2 Runtime	2: AV	90
Secondary Filter 1 Inlet Pressure PS5a	2: AV	91
Secondary Filter 2 Inlet Pressure PS5b	2: AV	92
Secondary Filter 1 Differential Pressure (PS5a – PS2)	2: AV	93
Secondary Filter 2 Differential Pressure (PS5b – PS2)	2: AV	94
Controller Up-time	2: AV	96
System (Group) Average Secondary Differential Pressure	2: AV	97
System (Group) Total Secondary Flow Rate	2: AV	98
Primary Return Temperature T5	2: AV	99
Primary Duty	2: AV	100

This page intentionally left blank

Appendix F: Warranty Details

F.1 Limited Product and Service Warranty

Extended warranties, service and maintenance programs are available in most locations, details available upon request. To obtain further details of limited warranty, also after sales service offerings, contact your local sales representative or technical support if you have any questions or problems during unit installation.

This page intentionally left blank

This page intentionally left blank

Appendix H: Disposal Information

NOTE: Waste materials must be disposed of in a responsible manner in line with environmental regulations.

The de-commissioning and disposal of this product should be undertaken by qualified personnel in adherence to local and national safety regulations, particularly for protection of lungs, eyes and skin from chemicals, dust etc. Approved lifting gear and power tools should be used and access to the work area must be restricted to authorized personnel.

The following steps are a guide only and should be adjusted to take into account local site conditions:

1. Disconnect unit from electrical supply.
2. Drain and dispose of any heat transfer fluid through an approved recycling facility.
3. Remove unit to approved recycling facilities only.

This page intentionally left blank

Connect with Vertiv on Social Media



<https://www.facebook.com/vertiv/>



<https://www.instagram.com/vertiv/>



<https://www.linkedin.com/company/vertiv/>



<https://www.twitter.com/Vertiv/>



Vertiv.com | Vertiv Headquarters, 1050 Dearborn Drive, Columbus, OH, 43085, USA

© 2022 Vertiv Group Corp. All rights reserved. Vertiv™ and the Vertiv logo are trademarks or registered trademarks of Vertiv Group Corp. All other names and logos referred to are trade names, trademarks or registered trademarks of their respective owners. While every precaution has been taken to ensure accuracy and completeness here, Vertiv Group Corp. assumes no responsibility, and disclaims all liability, for damages resulting from use of this information or for any errors or omissions. Specifications, rebates and other promotional offers are subject to change at Vertiv's sole discretion upon notice.

SL-70616_REVB_07-22