



Solution: SR2N05020NAA1

1. Change Log.....	3
2. Site Planning Datasheet.....	4
3. Interconnection Guide (ICG).....	5
4. Field Supplied Cable & Part List	20
5. Vertiv MSR2 600mm IT Rack	21
6. Vertiv MSR2 Power Management Cabinet (PMC)	22
7. Vertiv Liebert CR019 with Plenums	23
8. Power Management Unit - 20kW (PMU20).....	24
9. PMU20 Terminal Blocks Size.....	25
10. Vertiv MSR2 – CT300 Cable Tray 300mm	26
11. Vertiv MSR2 - CT600 Cable Tray 600mm	27
12. Scope of Work	28

1. Change Log

Rev	Date	Author	Description	Number of Change
A	1/29/2024	MG	Initial Release	CO-1083702
B	4/4/2024	TK	Updated site planning datasheet, minor changes to interconnection guide, removal of SOW checklist	CO-1087618
C	6/10/2024	TK	Updated connection guide, added updated SOW checklist, updated design	CO-1091967

2. Site Planning Datasheet

Smart Row 2 Site Planning Datasheet (208V, 3 phase, 4 wire + PE)

Configuration Number	Part Number	Max Row Capacity (kW)	IT Racks per Row	Capacity per Rack (kW)	Cooling Units per Row	pdu count	Main Input Breaker Size ⁶	Per Condenser Breaker Size	Per Condenser Dry Weight kg (lbs)	Row Dimensions (L x H x D) mm (in) ⁷	Row Weight kg (lbs)	Min. Staging Area m ² (ft ²)
1	SR2N02010NAA1	10	2	5	1	2	100A	N/A ⁵	60 (132.3)	2100 (82.7) x 2271 (107) x 1400 (55.2)	1463 (3227)	14.41 (155.2)
2	SR2N02010PAA1	10	2	5	1	4	100A	N/A ⁵	60 (132.3)	2100 (82.7) x 2271 (107) x 1400 (55.2)	1491 (3288)	14.99 (161.4)
3	SR2N02010FAA1	10	2	5	2	4	100A	N/A ⁵	60 (132.3)	2400 (94.5) x 2271 (107) x 1400 (55.2)	2112 (4656)	17.67 (190.2)
4	SR2N03010NAA1	10	3	3	1	3	100A	N/A ⁵	60 (132.3)	2700 (106.3) x 2271 (107) x 1400 (55.2)	1633 (3601)	15.76 (169.7)
5	SR2N03010PAA1	10	3	3	1	6	100A	N/A ⁵	60 (132.3)	2700 (106.3) x 2271 (107) x 1400 (55.2)	1675 (3694)	16.34 (175.9)
6	SR2N03010FAA1	10	3	3	2	6	100A	N/A ⁵	60 (132.3)	3000 (118.2) x 2271 (107) x 1400 (55.2)	2296 (5061)	19.02 (204.8)
7	SR2N03020NAA1	20	3	6	1	3	175A	15A	118 (260.2)	2700 (106.3) x 2271 (107) x 1400 (55.2)	1863 (4108)	18.46 (198.8)
8	SR2N03020PAA1	20	3	6	1	6	175A	15A	118 (260.2)	2700 (106.3) x 2271 (107) x 1400 (55.2)	1905 (4201)	20.51 (220.8)
9	SR2N03020FAA1	20	3	6	2	6	175A	15A	118 (260.2)	3000 (118.2) x 2271 (107) x 1400 (55.2)	2526 (5568)	24.42 (262.9)
10	SR2N04020NAA1	20	4	5	1	4	175A	15A	118 (260.2)	3300 (130) x 2271 (107) x 1400 (55.2)	2033 (4483)	19.81 (213.3)
11	SR2N04020PAA1	20	4	5	1	8	175A	15A	118 (260.2)	3300 (130) x 2271 (107) x 1400 (55.2)	2089 (4607)	21.86 (235.3)
12	SR2N04020FAA1	20	4	5	2	8	175A	15A	118 (260.2)	3600 (141.8) x 2271 (107) x 1400 (55.2)	2710 (5974)	25.77 (277.4)
13	SR2N05020NAA1	20	5	4	1	5	175A	15A	118 (260.2)	3900 (153.6) x 2271 (107) x 1400 (55.2)	2203 (4858)	21.16 (227.8)
14	SR2N05020PAA1	20	5	4	1	10	175A	15A	118 (260.2)	3900 (153.6) x 2271 (107) x 1400 (55.2)	2273 (5012)	23.21 (249.9)
15	SR2N05020FAA1	20	5	4	2	10	175A	15A	118 (260.2)	4200 (165.4) x 2271 (107) x 1400 (55.2)	2894 (6380)	27.12 (292)

Notes:

- System Environmental Conditions: Indoors, 41 °F to 104 °F (5 °C to 40 °C), RH to 80% with Max dew point of 82.4 °F (28 °C)
- Floor surface must be level and continuous (expansion joints sealed, raised floor tile gaps sealed, no floor drains, etc).
- No building sprinkler head should be within 19.7 in (0.5 m).
- Install in accordance with national and local electrical codes
- 10kW condenser power is sourced from the indoor unit
- Cable Sizing: 100A = 3 AWG ; 175A = 2/0 AWG
- Row Dimensions do not include necessary space needed for access including per ADA or local codes.

SHEET NO.	DRAWN BY:	© 2023, VERTIV GROUP CORPORATION. CONFIDENTIAL AND PROPRIETARY. ALL RIGHTS RESERVED. VERTIV AND THE VERTIV LOGO ARE TRADEMARKS OR REGISTERED TRADEMARKS OF VERTIV GROUP CORPORATION. THIS DOCUMENT AND THE INFORMATION IT CONTAINS ARE THE PROPERTY OF VERTIV GROUP CORPORATION. BY ACCEPTING IT INTO YOUR POSSESSION, YOU AGREE THAT YOU WILL KEEP THIS DOCUMENT AND ALL INFORMATION CONTAINED HEREIN IN STRICTEST CONFIDENCE AND WILL NOT COPY, REPRODUCE, RETRANSMIT, USE (EXCEPT SOLELY FOR THE BENEFIT OF VERTIV GROUP CORPORATION), SELL, LEND, OR OTHERWISE DISPOSE OF SAME, DIRECTLY OR INDIRECTLY, WITHOUT THE EXPRESS WRITTEN PERMISSION OF VERTIV GROUP CORPORATION. PERMISSION TO REPRODUCE THIS DOCUMENT IS LIMITED TO THE ORIGINAL INTENT AND SHALL BE IMMEDIATELY UPON REQUEST.	DWG. NO. DATE (LATEST REV)	
	DESIGNED BY:			
CO. NO.	TITLE	Smart Row 2 Site Planning Datasheet (208V, 3 phase, 4 wire + PE)		
REF. DWG.	APPROVED BY:			

3. Interconnection Guide (ICG)

<p>0 1 2 3 4 5 6 7 8 9</p>		<p>VERTIV™</p>	<p>Vertiv™ SmartRow™ 2: 5x IT Rack 20kW</p>	<p>Row IT Load Capacity: 20 kW Power Redundancy UPS: No Power Redundancy rPDU: No Cooling Redundancy: No Dimensions: Length: 12.8 ft [3900 mm] Depth: 4.6 ft [1400 mm] Height: 7.38 ft [2250 mm]</p>	<p>SHEET NO. 1 / 15 CHANGE NO. PAGE DESCRIPTION: 1- Title page / cover sheet</p>	<p>DRAWN BY: Nilesch Patil APPROVED BY: Jakub Fencel</p> <p>© 2020 VERTIV GROUP CORPORATION. CONFIDENTIAL AND PROPRIETARY. ALL RIGHTS RESERVED. VERTIV AND THE VERTIV LOGO ARE TRADEMARKS OR REGISTERED TRADEMARKS OF VERTIV GROUP CORPORATION. THIS DOCUMENT (AND THE INFORMATION IT CONTAINS) ARE THE PROPERTY OF VERTIV GROUP CORPORATION. BY ACCEPTING INTO YOUR POSSESSION OR USING THIS DOCUMENT, YOU AGREE THAT YOU WILL KEEP THIS DOCUMENT AND ALL INFORMATION CONTAINED HEREIN IN STRICTEST CONFIDENCE AND WILL NOT COPY, REPRODUCE, RETRANSMIT, USE (EXCEPT SOLELY FOR THE BENEFIT OF VERTIV GROUP CORPORATION), SELL, LEND, OR OTHERWISE DISPOSE OF SAME, DIRECTLY OR INDIRECTLY, WITHOUT THE EXPRESS WRITTEN PERMISSION OF VERTIV GROUP CORPORATION, AND THIS DOCUMENT SHALL BE RETURNED TO VERTIV GROUP CORPORATION IMMEDIATELY UPON REQUEST.</p> <p>TITLE / DESCRIPTION: Vertiv™ SmartRow™ 2: 5x IT Rack 20kW</p> <p>DWG NO. SR2N05020NAA1 DATE (LATEST REV.) REVISION: 505 N. CLEVELAND AVE WESTERVILLE OH 43081</p> <p>VERTIV™</p>
----------------------------	--	-----------------------	---	---	--	--

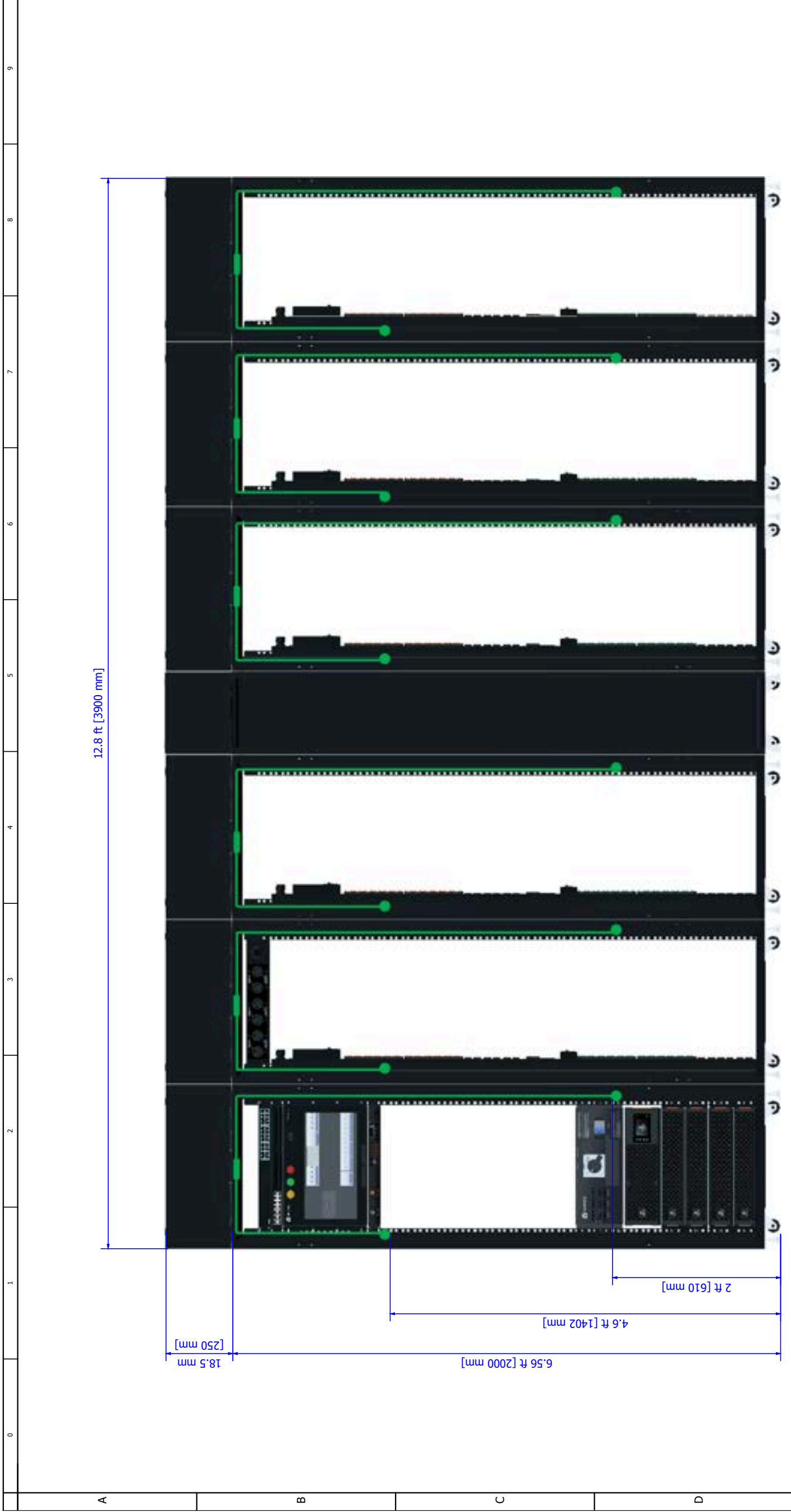

Front View

Notes:

1. Row IT Load Capacity is driven by number of IT-Racks (IT-Rack x 4 kW per rack).
2. System Environmental Conditions: Indoors, 41 F to 104 F (5 C to 40 C), RH to 80% with Max dew point of 82.4 F (28 C).
3. Floor surface must be level and continuous (expansion joints sealed, raised floor tile gaps sealed, no floor drains, etc).
4. No building sprinkler head should be within 19.7 in (0.5 m).

- 2T Sensor mounted on rack roof
- 2T Sensor probe

SHEET NO. 2 / 15	DRAWN BY: Nilesh Patil	DWG NO. SR2N05020NAA1	
CHANGE NO.	APPROVED BY: Jakub Fenc	DATE (LATEST REV.)	
PAGE DESCRIPTION: 2 - vRow Front View	TITLE / DESCRIPTION: Vertiv™ SmartRow™ 2: 5x IT Rack 20kW	REVISION: 505 N. CLEVELAND AVE WESTERVILLE OH 43081	

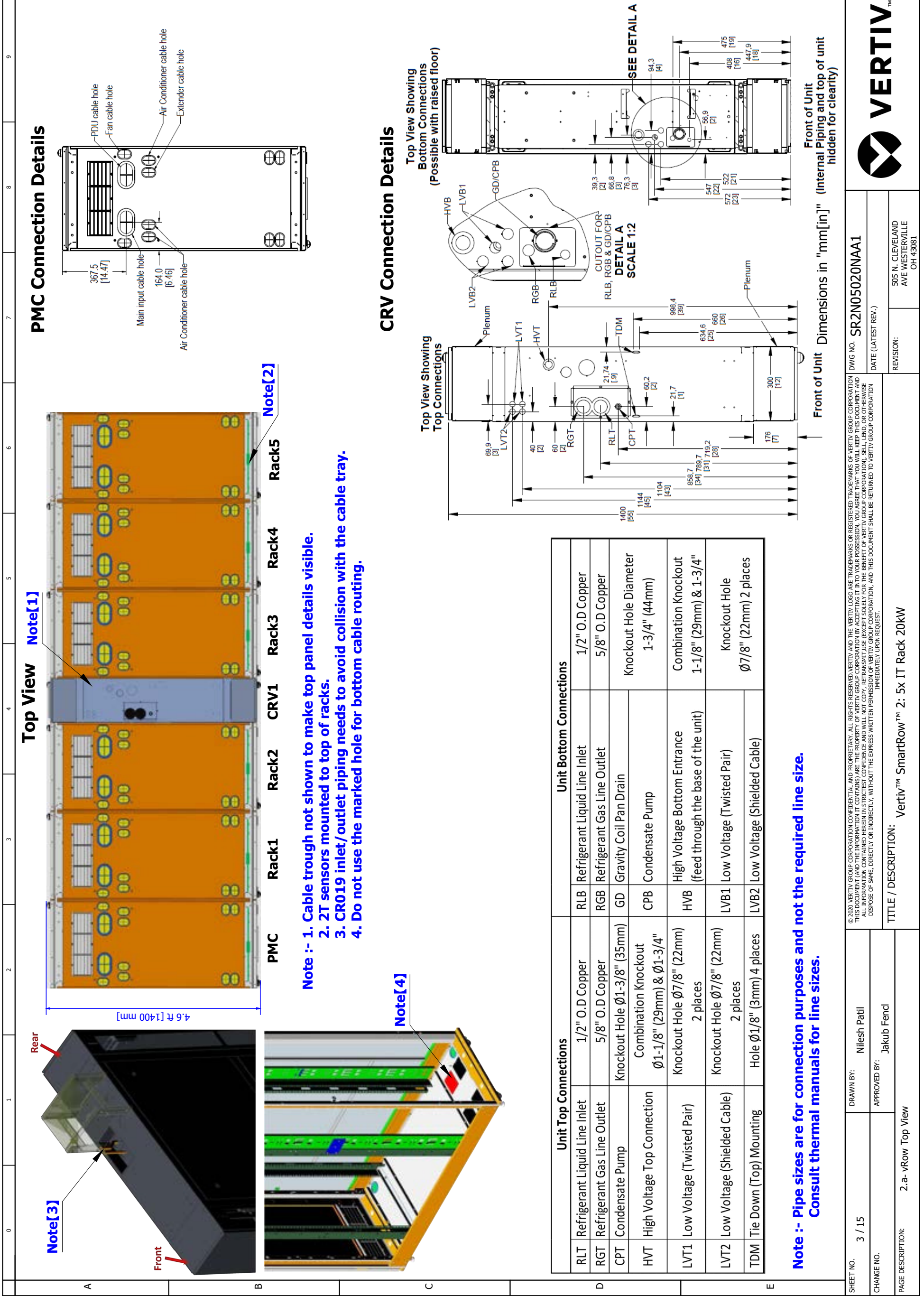

PMC Connection Details

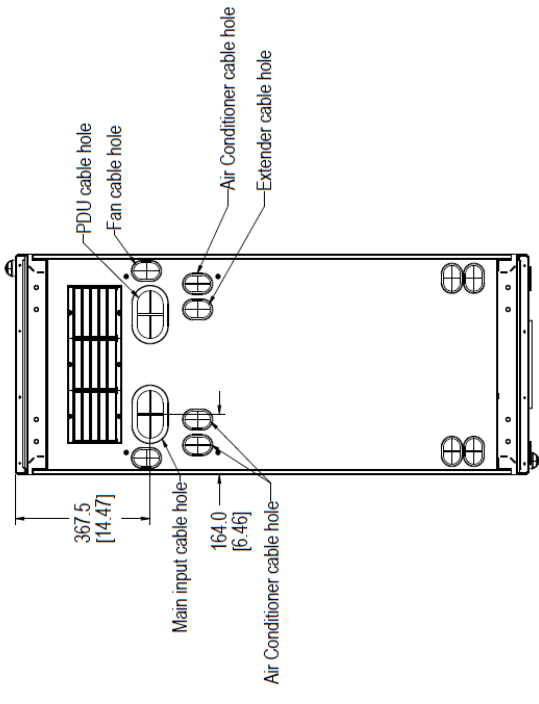

CRV Connection Details

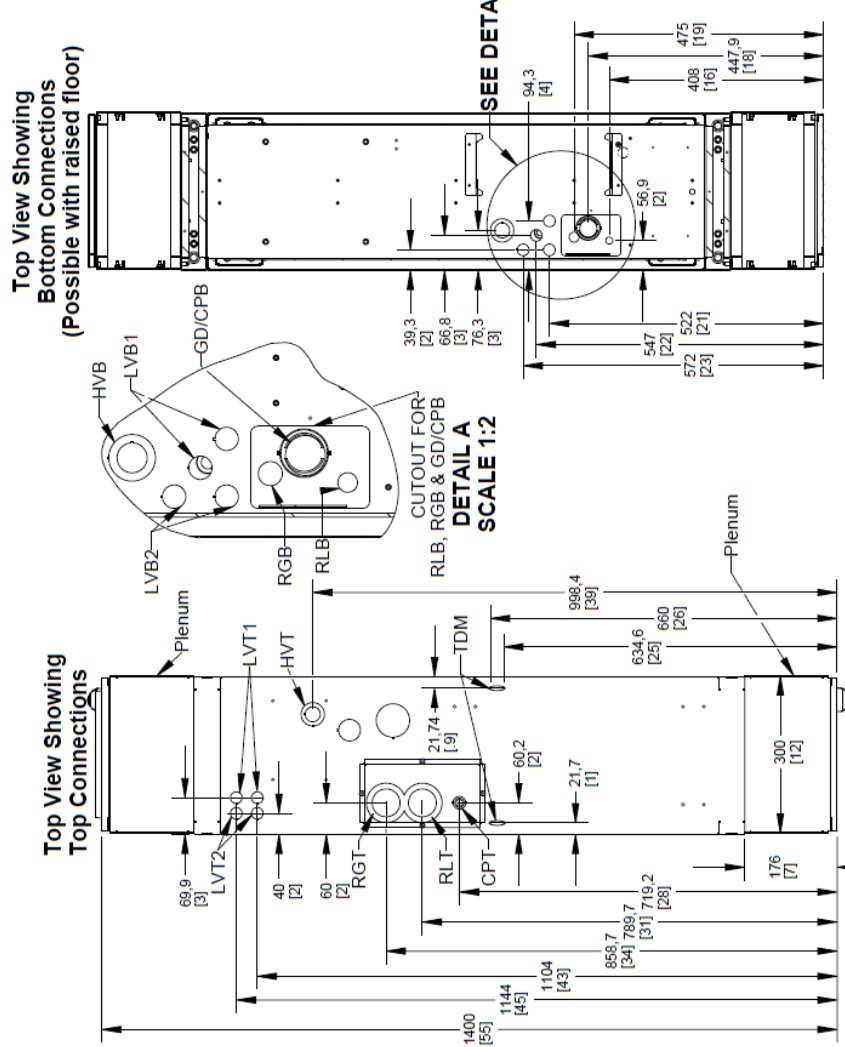

Unit Top Connections		Unit Bottom Connections	
RLT	Refrigerant Liquid Line Inlet	RLB	Refrigerant Liquid Line Inlet
RGT	Refrigerant Gas Line Outlet	RGB	Refrigerant Gas Line Outlet
CPT	Condensate Pump	GD	Gravity Coil Pan Drain
HVT	High Voltage Top Connection	CPB	Condensate Pump
LVT1	Low Voltage (Twisted Pair)	HVB	High Voltage Bottom Entrance (feed through the base of the unit)
LVT2	Low Voltage (Shielded Cable)	LVB1	Low Voltage (Twisted Pair)
TDM	Tie Down (Top) Mounting	LVB2	Low Voltage (Shielded Cable)

- Note :-**
1. Cable trough not shown to make top panel details visible.
 2. 2T sensors mounted to top of racks.
 3. CR019 inlet/outlet piping needs to avoid collision with the cable tray.
 4. Do not use the marked hole for bottom cable routing.

Note :- Pipe sizes are for connection purposes and not the required line size. Consult thermal manuals for line sizes.

SHEET NO. 3 / 15	DRAWN BY: Nilesh Patil	DWG NO. SR2N05020NAA1	
CHANGE NO.	APPROVED BY: Jakub Fend	DATE (LATEST REV.)	
PAGE DESCRIPTION: 2. a-vRow Top View	TITLE / DESCRIPTION: Vertiv™ SmartRow™ 2: 5x IT Rack 20kW	REVISION: 505 N. CLEVELAND AVE WESTERVILLE OH 43081	



Cable overview

Packaging No.	Cable Category	Cable No.	Tag1	Tag2	Length (inch/mm)	Description
0411A817	Water immersion to RDU501	W120	Water Leak1	RDU501_DI1	137.8/3500	Water immersion 1 to RDU501 communication cable
	Smart door lock cascade cable	W201	PMC-LOCK	RACK1-LOCK	33.5/850	PMC to RACK1 power cascade cable
	Smart door lock cascade	W205	FLOCK7	8COM-COM3	137.8/3500	No.7 Lock front door to RDU501_COM3 communication cable
	Smart door lock cascade	W206	RLOCK7	8COM-COM4	189/4800	No.7 Lock rear door to RDU501_COM4 communication cable
	Smart door lock cascade cable	W210	PMC-LOCK	RACK1-LOCK	33.5/850	PMC to RACK1 F-Door communication cascade cable
	Smart door lock cascade cable	W210	PMC-LOCK	RACK1-LOCK	33.5/850	PMC to RACK1 R-Door communication cascade cable
	Smart door lock cascade cable	W201	RACK1-LOCK	RACK2-LOCK	33.5/850	RACK1 to RACK2 power cascade cable
	Smart door lock cascade cable	W210	RACK1-LOCK	RACK2-LOCK	33.5/850	RACK1 to RACK2 F-Door communication cascade cable
	Smart door lock cascade cable	W210	RACK1-LOCK	RACK2-LOCK	33.5/850	RACK1 to RACK2 R-Door communication cascade cable
	Smart door lock cascade cable	W204	CRV1-LOCK	RACK3-LOCK	33.5/850	CRV1 to RACK3 power cascade cable
	CRV's microswitch and Smart door lock cascade	W206/W207	I-LOCK	F-R/BK, R-R/BK	82.7/2100	Smart door lock cable from front door to rear door in CRV1
	Smart door lock cascade cable	W207	CRV1-LOCK	RACK3-LOCK	57.1/1450	CRV1 to RACK3 F-Door communication cascade cable
	Smart door lock cascade cable	W207	RACK2-LOCK	CRV1-LOCK	57.1/1450	RACK2 to CRV1 R-Door communication cascade cable
	Smart door lock cascade cable	W203	RACK2-LOCK	CRV1-LOCK	13.8/350	RACK2 to CRV1 power cascade cable (AC in the middle position)
	Smart door lock cascade cable	W209	RACK2-LOCK	CRV1-LOCK	13.8/350	RACK2 to CRV1 F-Door communication cascade cable
	Smart door lock cascade cable	W209	RACK2-LOCK	CRV1-LOCK	13.8/350	RACK2 to CRV1 R-Door communication cascade cable
	Smart door lock cascade cable	W201	RACK3-LOCK	RACK4-LOCK	33.5/850	RACK3 to RACK4 power cascade cable
	Smart door lock cascade cable	W210	RACK3-LOCK	RACK4-LOCK	33.5/850	RACK3 to RACK4 F-Door communication cascade cable
	Smart door lock cascade cable	W210	RACK3-LOCK	RACK4-LOCK	33.5/850	RACK3 to RACK4 R-Door communication cascade cable
	Smart door lock cascade cable	W201	RACK4-LOCK	RACK5-LOCK	33.5/850	RACK4 to RACK5 power cascade cable
	Front door light cascade cable	W216	PMC_FLIGHT	RACK1_FLIGHT	29.5/750	PMC to RACK1 front door LED light cascade cable
	Front door microswitch cascade cable	W218	PMC_F-SW	RACK1_F-SW	29.5/750	PMC to RACK1 Cascade cables for front door microswitches
	Rear door microswitch cascade cable	W221	PMC_R-SW	RACK1_R-SW	29.5/750	PMC to RACK1 rear door microswitch cascade cable
	Rear door light cascade cable	W225	PMC_RLIGHT	RACK1_R-SW	29.5/750	PMC to RACK1 rear door LED light cascade cable
	CRV's microswitch and Smart door lock cascade	W401-S	RDU:Smoke1	W401-S 385	118.11/3000	Microswitch communication cable from PMC to CRV1
	Front door light cascade cable	W216	RACK1_FLIGHT	RACK2_FLIGHT	29.5/750	RACK1 to RACK2 front door LED light cascade cable
	Front door microswitch cascade cable	W218	RACK1_F-SW	RACK2_F-SW	29.5/750	RACK1 to RACK2 Cascade cables for front door microswitches

SHEET NO. 4 / 15	DRAWN BY: Nilesh Patil	DWG NO. SR2N05020NAA1	
CHANGE NO.	APPROVED BY: Jakub Fendl	REVISION: DATE (LATEST REV.)	REVISION: 505 N. CLEVELAND AVE WESTERVILLE OH 43081
PAGE DESCRIPTION: 3- Cable overview : =vRow+9CRV1-W120 - =vRow+11Rack2-W218		TITLE / DESCRIPTION: Vertiv™ SmartRow™ 2: 5x IT Rack 20kW	
© 2024 VERTIV GROUP CORPORATION. CONFIDENTIAL AND PROPRIETARY. ALL RIGHTS RESERVED. VERTIV AND THE VERTIV LOGO ARE TRADEMARKS OR REGISTERED TRADEMARKS OF VERTIV GROUP CORPORATION. THIS DOCUMENT AND THE INFORMATION IT CONTAINS ARE THE PROPERTY OF VERTIV GROUP CORPORATION. BY ACCEPTING IT INTO YOUR POSSESSION, YOU AGREE THAT YOU WILL KEEP THIS DOCUMENT AND ALL INFORMATION CONTAINED HEREIN IN STRICTEST CONFIDENCE AND WILL NOT COPY, REPRODUCE, TRANSMIT, OR OTHERWISE DISCLOSE IT TO ANY OTHER PERSON OR ENTITY WITHOUT THE WRITTEN PERMISSION OF VERTIV GROUP CORPORATION. THIS DOCUMENT SHALL BE RETURNED TO VERTIV GROUP CORPORATION IMMEDIATELY UPON REQUEST.			

Cable overview

Packaging No.	Cable Category	Cable No.	Tag1	Tag2	Length (inch/mm)	Description
0411A817	Front door microswitch cascade cable	W221	RACK1_F-SW	RACK2_F-SW	29.5/750	RACK1 to RACK2 Cascade cables for rear door microswitches
	Rear door light cascade cable	W225	RACK1_RLIGHT	RACK2_R-SW	29.5/750	RACK1 to RACK2 rear door LED light cascade cable
	Front door light cascade cable	W215	RACK2_FLIGHT	RACK3_FLIGHT	41.3/1050	RACK2 to RACK3 Front door LED light cascade cable
	Front door microswitch cascade cable	W219	RACK2_F-SW	RACK3_F-SW	41.3/1050	RACK2 to RACK3 Cascade cable for front door microswitches
	Front door microswitch cascade cable	W222	RACK2_F-SW	RACK3_F-SW	41.3/1050	RACK2 to RACK3 Cascade cable for rear door microswitches
	Rear door light cascade cable	W224	RACK2_RLIGHT	RACK3_R-SW	41.3/1050	RACK2 to RACK3 rear door LED light cascade cable
	Front door light cascade cable	W216	RACK3_FLIGHT	RACK4_FLIGHT	29.5/750	RACK3 to RACK4 front door LED light cascade cable
	Front door microswitch cascade cable	W218	RACK3_F-SW	RACK4_F-SW	29.5/750	RACK3 to RACK4 Cascade cables for front door microswitches
	Front door microswitch cascade cable	W221	RACK3_F-SW	RACK4_F-SW	29.5/750	RACK3 to RACK4 Cascade cables for rear door microswitches
	Rear door light cascade cable	W225	RACK3_RLIGHT	RACK4_R-SW	29.5/750	RACK3 to RACK4 rear door LED light cascade cable
	Front door light cascade cable	W217	RACK4_FLIGHT	RACK5_FLIGHT	29.5/750	Cascade cable for the end RACK front door light
	Front door microswitch cascade cable	W220	RACK4_F-SW	RACK5_F-SW	29.5/750	RACK4 to RACK5 Cascade cable for microswitches on the front door of the end cabinet
	Front door microswitch cascade cable	W223	RACK4_F-SW	RACK5_F-SW	29.5/750	RACK4 to RACK5 Cascade cable for rear door microswitch of end RACK
	Front door light cascade cable	W226	RACK4_RLIGHT	RACK5_RLIGHT	29.5/750	Cascade cable for the end RACK rear door light
	THD cascading	W212	PMC-THD-RJ2	RACK1-THD-RJ1	33.5/850	PMC to RACK1 Cascade Cable
	Emergency fan to FC	W229	FC Port1	PMC-FAN	59.1/1500	PMC Emergency fan to FC controller cable
	Emergency fan to FC	W213	FC Port2	RACK1-FAN	122/3100	Rack1 Emergency fan to FC controller cable (shorter)
	THD cascading	W212	RACK1-THD-RJ2	RACK2-THD-RJ1	33.5/850	RACK1 to RACK2 Cascade Cable
	Emergency fan to FC	W213	FC Port3	RACK2-FAN	122/3100	Rack2 Emergency fan to FC controller cable (shorter)
	THD cascading	W212	RACK3-THD-RJ2	RACK4-THD-RJ1	33.5/850	RACK3 to RACK4 Cascade Cable
	Emergency fan to FC	W214	FC Port4	RACK3-FAN	177.2/4500	Rack3 Emergency fan to FC controller cable (longer)
	THD cascading	W212	RACK4-THD-RJ2	RACK5-THD-RJ1	33.5/850	RACK4 to RACK5 Cascade Cable
	Emergency fan to FC	W214	FC Port5	RACK4-FAN	177.2/4500	Rack4 Emergency fan to FC controller cable (longer)
	Emergency fan to FC	W214	FC Port6	RACK5-FAN	177.2/4500	Rack5 Emergency fan to FC controller cable (longer)
	THD cascading	W211	RACK2-THD-RJ2	RACK3-THD-RJ1	45.3/1150	RACK2 to RACK3 Cascade Cable
	Smart door lock cascade cable	W205	FLOCK7	8COM-COM3	137.8/3500	No.7 Lock front door to RDU501_ COM3 communication cable
	Smart door lock cascade cable	W206	RLOCK7	8COM-COM4	189/4800	No.7 Lock rear door to RDU501_ COM4 communication cable

SHEET NO. 5 / 15 CHANGE NO.	DRAWN BY: Nilesh Patil APPROVED BY: Jakub Fend	DWG NO. SR2N05020NAA1 REVISION: DATE (LATEST REV.) 505 N. CLEVELAND AVE WESTERVILLE OH 43081	 
3.a- Cable overview : =vRow+11Rack2-W221 - =vRow+COM4-W206		© 2024 VERTIV GROUP CORPORATION. CONFIDENTIAL AND PROPRIETARY. ALL RIGHTS RESERVED. VERTIV AND THE VERTIV LOGO ARE TRADEMARKS OR REGISTERED TRADEMARKS OF VERTIV GROUP CORPORATION. THIS DOCUMENT AND THE INFORMATION IT CONTAINS ARE THE PROPERTY OF VERTIV GROUP CORPORATION. BY ACCEPTING IT INTO YOUR POSSESSION, YOU AGREE THAT YOU WILL KEEP THIS DOCUMENT AND ALL INFORMATION CONTAINED HEREIN IN STRICTEST CONFIDENCE AND WILL NOT COPY, REPRODUCE, RE-TRANSMIT, USE (EXCEPT SOLELY FOR THE BENEFIT OF VERTIV GROUP CORPORATION), SELL, LEND, OR OTHERWISE DISPOSE OF SAME, DIRECTLY OR INDIRECTLY, WITHOUT THE EXPRESS WRITTEN PERMISSION OF VERTIV GROUP CORPORATION. AND THIS DOCUMENT SHALL BE RETURNED TO VERTIV GROUP CORPORATION IMMEDIATELY UPON REQUEST.	
TITLE / DESCRIPTION: Vertiv™ SmartRow™ 2: 5x IT Rack 20kW			

Packaging No.	Cable Category	Cable No.	Tag1	Tag2	Length (inch/mm)	Description
0411A860	Communication cable	W116	PDU1A	PDU2A	157.5/4000	PDU1A to PDU2A communication cable
	Communication cable	W114	FC	Switcher(From FC)	70.9/1800	FC to Switch communication cable
	Communication cable	W115	PDU	Switcher(From PDU)	137.8/3500	PDU to Switch communication cable
	Communication cable	W119	RDU501	Switcher(From RDU501)	47.2/1200	RDU501 to Switch Communication Cable
	Communication cable	W116	PDU2A	PDU3A	157.5/4000	PDU2A to PDU3A communication cable
	Communication cable	W116	PDU3A	PDU3B	157.5/4000	PDU3A to PDU3B communication cable
	Communication cable	W116	PDU4A	PDU5A	157.5/4000	PDU4A to PDU5A communication cable
	Power cable	W11	PMU	CRV1 L1 L2 N G	72/1830	PMU to CRV1 power cable
	Communication cable	W110	CRV1	Switcher(From CRV1)	137.8/3500	CRV1 to Switch communication cable
	Power cable	W01	PMU_TO MBC1 INPUT L1 L2 N G	MBC1 MAIN INPUT L1 L2 N G	51.2/1300	PMU to MBC1 power cable (MBC1 input)
0411A901	Power cable	W03	MBC1 MAIN OUTPUT L1 L2 N	PMU_TO MBC1 OUTPUT L1 L2 N	76.8/1950	MBC1 to PMU power cable (MBC1 output)
	Power cable	W05	MBC1_TO UPS1 INPUT L1 L2 N G	UPS1 INPUT L1 L2 N G	39.4/1000	MBC1 to UPS1 power cable (UPS1 input)
	Power cable	W07	UPS1 OUTPUT L1 L2 N G	MBC1_FROM UPS1 O/P L1 L2 N G	39.4/1000	UPS1 to MBC1 power cable (UPS1 output)
	Power cable	W09	PMU	Extender1 L1 L2 N G	102.4/2600	PMU to Extender1 power cable
	Communication cable	W112	UPS1	Switcher(From UPS1)	177.2/4500	UPS 1 to Switch communication cable
	Communication cable	W118	NVR	Switcher(From NVR)	47.2/1200	NVR to Switch Communication Cable
	Power cable (Factory assembled)	W14	PMU-RLIGHT DC+ DC-	PMC-RLIGHT	47.2/1200	PMU to PMC rear door LED light power cable
	Power cable (Factory assembled)	W16	PMU-FLIGHT FWH FRE FBK FBL	PMC-FLIGHT	68.9/1750	PMU to PMC front door LED light power cable
	Power cable (Factory assembled)	W18	PMU-F-SW FCOM FNC	PMC-F-SW	49.2/1250	PMU to PMC front door microswitch power cable
	Power cable (Factory assembled)	W19	PMU-R-SW FCOM FNC	PMC-R-SW	49.2/1250	PMU to PMC rear door microswitch power cable
0411A901	Power cable (Factory assembled)	W13	PMU-LOCK DC+ DC-	PMC-LOCK	43.3/1100	PMU to PMC intelligent door lock power cable
	Communication cable (factory assembled)	W101	PMC-FLOCK	8COM-COM1	35.4/900	PMC to RDU501_COM1 intelligent door lock front door communication cable
	Communication cable (factory assembled)	W107	PMU-RLOCK	8COM-COM2	70.9/1800	PMC to RDU501_COM2 intelligent door lock rear door communication cable
	Communication cable (factory assembled)	W109	RDU501-Sensor1	THD-RJ1	27.6/700	RDU501 to PMC cabinet THD communication cable
	Power cable (Factory assembled)	W15	HMI-P	PMU-HMI DC+ DC-	59.1/1500	PMU to HMI power cable
	Communication cable (factory assembled)	W102	PMU-DO2	RDU501-DO2	70.9/1800	PMU to RDU501 D02 Control Red Light Cable
	Communication cable (factory assembled)	W104	PMU-DI	4DI-RJ451	66.9/1700	PMU to 4DI SPD communication network cable
	Communication cable (factory assembled)	W104	PMU-DI	4DI-RJ451	66.9/1700	PMU to 4DI SPD communication network cable
	Communication cable (factory assembled)	W104	PMU-DI	4DI-RJ451	66.9/1700	PMU to 4DI SPD communication network cable
	Communication cable (factory assembled)	W104	PMU-DI	4DI-RJ451	66.9/1700	PMU to 4DI SPD communication network cable

SHEET NO. 6 / 15	DRAWN BY: Nilesh Patil	DWC NO. SR2N05020NAA1	DATE (LATEST REV.)	REVISION: 505 N. CLEVELAND AVE WESTERVILLE OH 43081	VERTIV™
	APPROVED BY: Jakub Fend				
CHANGE NO.	TITLE / DESCRIPTION: Vertiv™ SmartRow™ 2: 5x IT Rack 20kW				
PAGE DESCRIPTION: 3.b- Cable overview : =vRow+System blocks drawing-W116 - =vRow±16PMU-W104					

0	1	2	3	4	5	6	7	8	9																													
Cable overview																																						
A	<table border="1" style="width: 100%; border-collapse: collapse;"> <thead> <tr> <th style="width: 15%;">Packaging No.</th> <th style="width: 25%;">Cable Category</th> <th style="width: 15%;">Cable No.</th> <th style="width: 15%;">Tag1</th> <th style="width: 15%;">Tag2</th> <th style="width: 15%;">Length (inch/mm)</th> <th style="width: 20%;">Description</th> </tr> </thead> <tbody> <tr> <td>0411A901</td> <td>Communication cable (factory assembled)</td> <td>W105</td> <td>PMU-RS485</td> <td>RDU501-COM3</td> <td>70.9/1800</td> <td>PMU to RDU501 COM3 meter communication network cable</td> </tr> <tr> <td></td> <td>Communication cable (factory assembled)</td> <td>W106</td> <td>4DI-DI1</td> <td>RDU501-Sensor2</td> <td>11.8/300</td> <td>4DI to RDU501 Smoke 2 SPD Communication Network Cable</td> </tr> <tr> <td></td> <td>Communication cable (factory assembled)</td> <td>W108</td> <td>HMI_485-2</td> <td>HMI-C</td> <td>29.5/750</td> <td>RDU501 COM2 to HMI communication cable</td> </tr> </tbody> </table>		Packaging No.	Cable Category	Cable No.	Tag1	Tag2	Length (inch/mm)	Description	0411A901	Communication cable (factory assembled)	W105	PMU-RS485	RDU501-COM3	70.9/1800	PMU to RDU501 COM3 meter communication network cable		Communication cable (factory assembled)	W106	4DI-DI1	RDU501-Sensor2	11.8/300	4DI to RDU501 Smoke 2 SPD Communication Network Cable		Communication cable (factory assembled)	W108	HMI_485-2	HMI-C	29.5/750	RDU501 COM2 to HMI communication cable								
Packaging No.	Cable Category	Cable No.	Tag1	Tag2	Length (inch/mm)	Description																																
0411A901	Communication cable (factory assembled)	W105	PMU-RS485	RDU501-COM3	70.9/1800	PMU to RDU501 COM3 meter communication network cable																																
	Communication cable (factory assembled)	W106	4DI-DI1	RDU501-Sensor2	11.8/300	4DI to RDU501 Smoke 2 SPD Communication Network Cable																																
	Communication cable (factory assembled)	W108	HMI_485-2	HMI-C	29.5/750	RDU501 COM2 to HMI communication cable																																
B																																						
C																																						
D																																						
E																																						
SHEET NO. 7 / 15 CHANGE NO. PAGE DESCRIPTION: 3.c- Cable overview : =vRow+16PMU-W105 - =vRow+16PMU-W108		DRAWN BY: Nilesch Patil APPROVED BY: Jakub Fendl		© 2024 VERTIV GROUP CORPORATION. CONFIDENTIAL AND PROPRIETARY. ALL RIGHTS RESERVED. VERTIV AND THE VERTIV LOGO ARE TRADEMARKS OR REGISTERED TRADEMARKS OF VERTIV GROUP CORPORATION. THIS DOCUMENT (AND THE INFORMATION IT CONTAINS) ARE THE PROPERTY OF VERTIV GROUP CORPORATION. BY ACCEPTING IT INTO YOUR POSSESSION, YOU AGREE THAT YOU WILL KEEP THIS DOCUMENT AND ALL INFORMATION CONTAINED HEREIN IN STRICTEST CONFIDENCE AND WILL NOT COPY, REPRODUCE, TRANSMIT, USE (EXCEPT SOLELY FOR THE BENEFIT OF VERTIV GROUP CORPORATION), SELL, LEND, OR OTHERWISE DISPOSE OF SAME, DIRECTLY OR INDIRECTLY, WITHOUT THE EXPRESS WRITTEN PERMISSION OF VERTIV GROUP CORPORATION, AND THIS DOCUMENT SHALL BE RETURNED TO VERTIV GROUP CORPORATION IMMEDIATELY UPON REQUEST.				DWG NO. SR2N05020NAA1 REVISION: DATE (LATEST REV.)		 VERTIV™ 505 N. CLEVELAND AVE WESTERVILLE OH 43081																												
TITLE / DESCRIPTION: Vertiv™ SmartRow™ 2: 5x IT Rack 20kW																																						

FC & Geist PDUs -SR2 for 20K(5*ITRack)

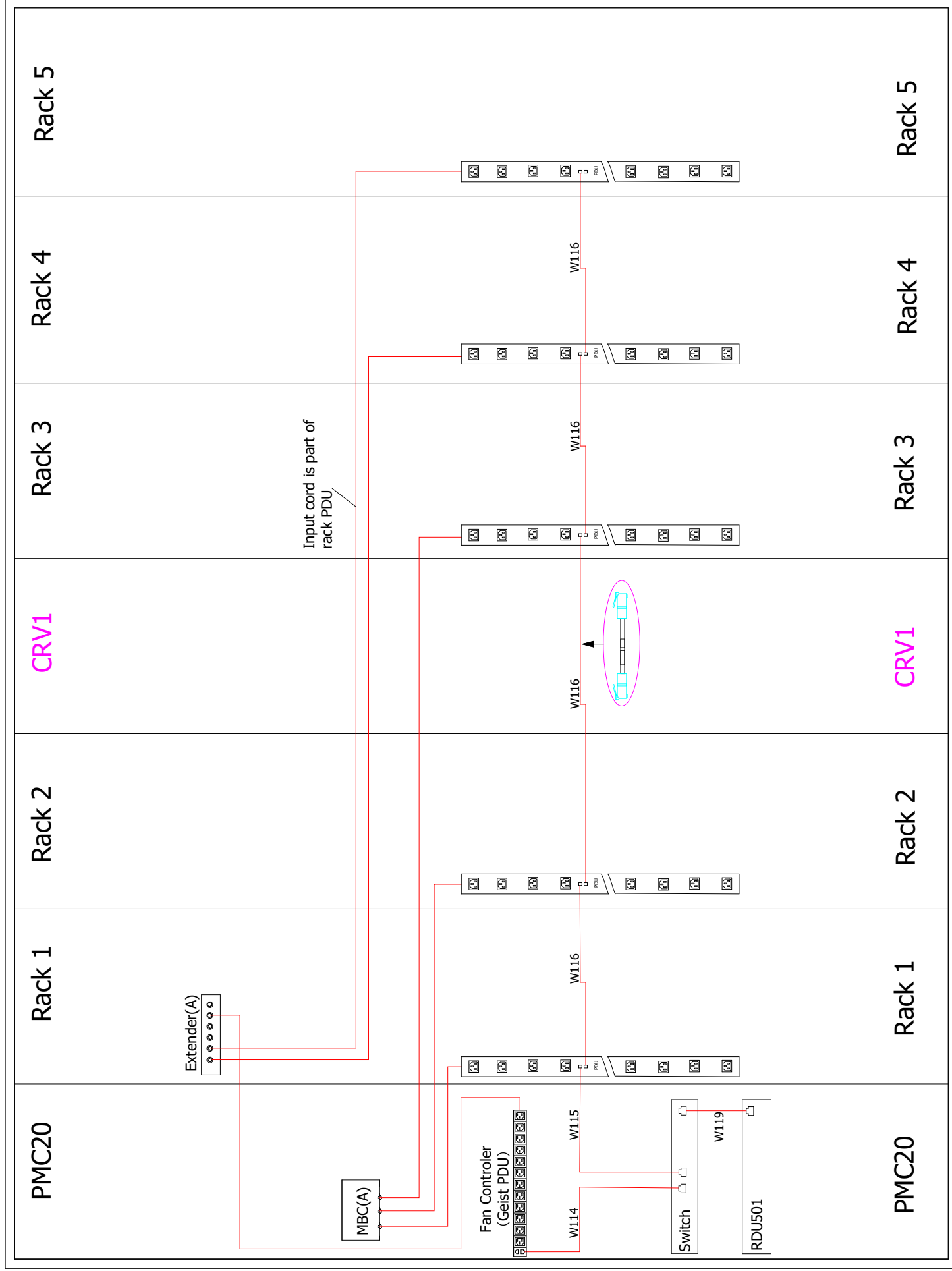

Cables connected at assembly

SHEET NO. 8 / 15	DRAWN BY: Nilesh Patil	DWG NO. SR2N05020NAA1	
CHANGE NO.	APPROVED BY: Jakub Fencel	DATE (LATEST REV.)	
PAGE DESCRIPTION: 4- PDU wiring diagram	TITLE / DESCRIPTION: Vertiv™ SmartRow™ 2: 5x IT Rack 20kW		REVISION: 505 N. CLEVELAND AVE. WESTERVILLE OH 43081

CRVs(CR019)-SR2 for 20K (5*ITRack)

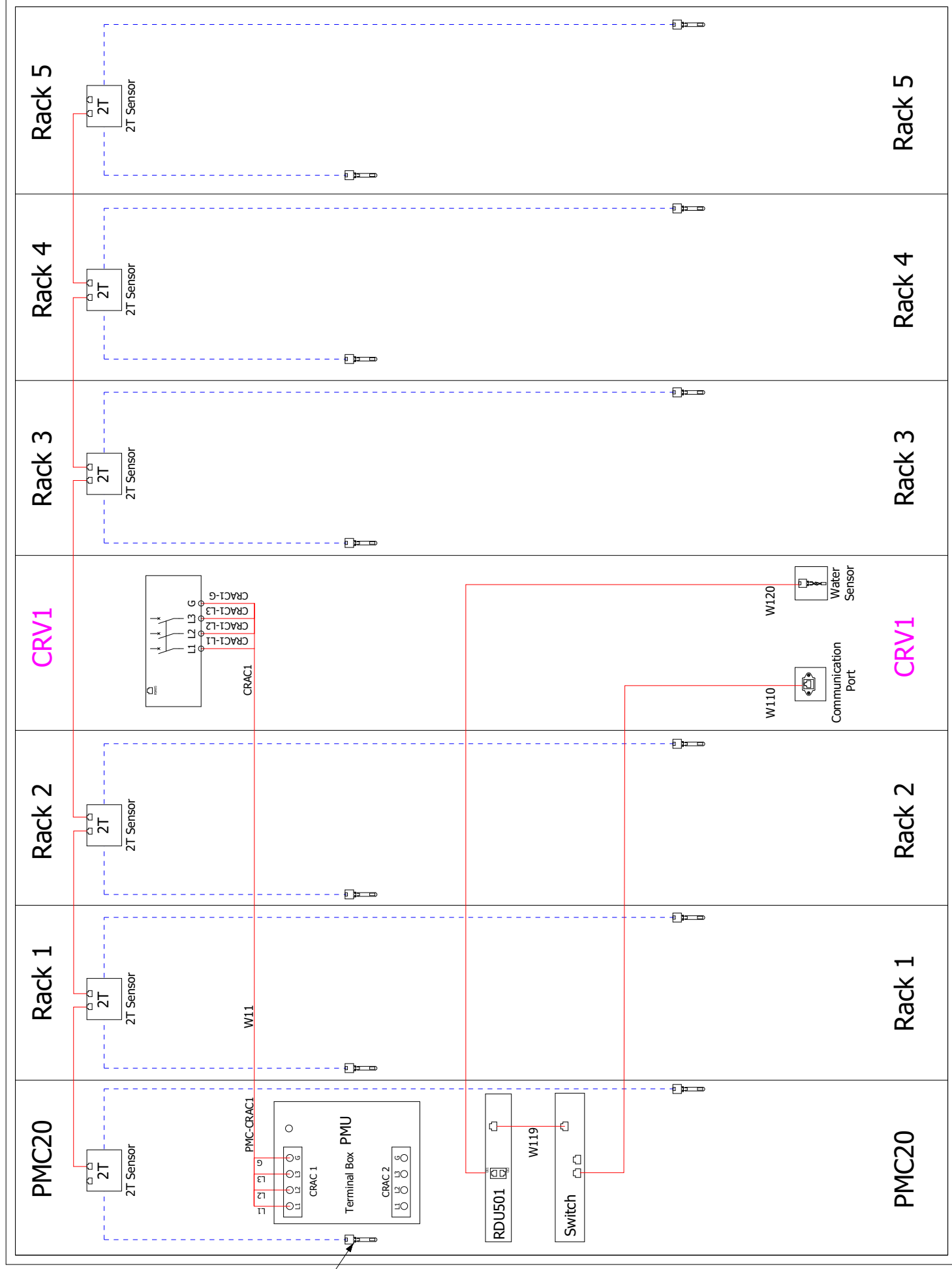

----- Factory connected cables
 _____ Cables connected at assembly

SHEET NO. 9 / 15	DRAWN BY: Nilesh Patil	DWG NO. SR2N05020NAA1	
CHANGE NO.	APPROVED BY: Jakub Fend	REVISION: DATE (LATEST REV.)	
PAGE DESCRIPTION: 4.a- Air conditioner wiring diagram	TITLE / DESCRIPTION: Vertiv™ SmartRow™ 2 : 5x IT Rack 20KW		505 N. CLEVELAND AVE WESTERVILLE OH 43081

Intelligent Locks -SR2 for 20K(Max 5*ITRack)

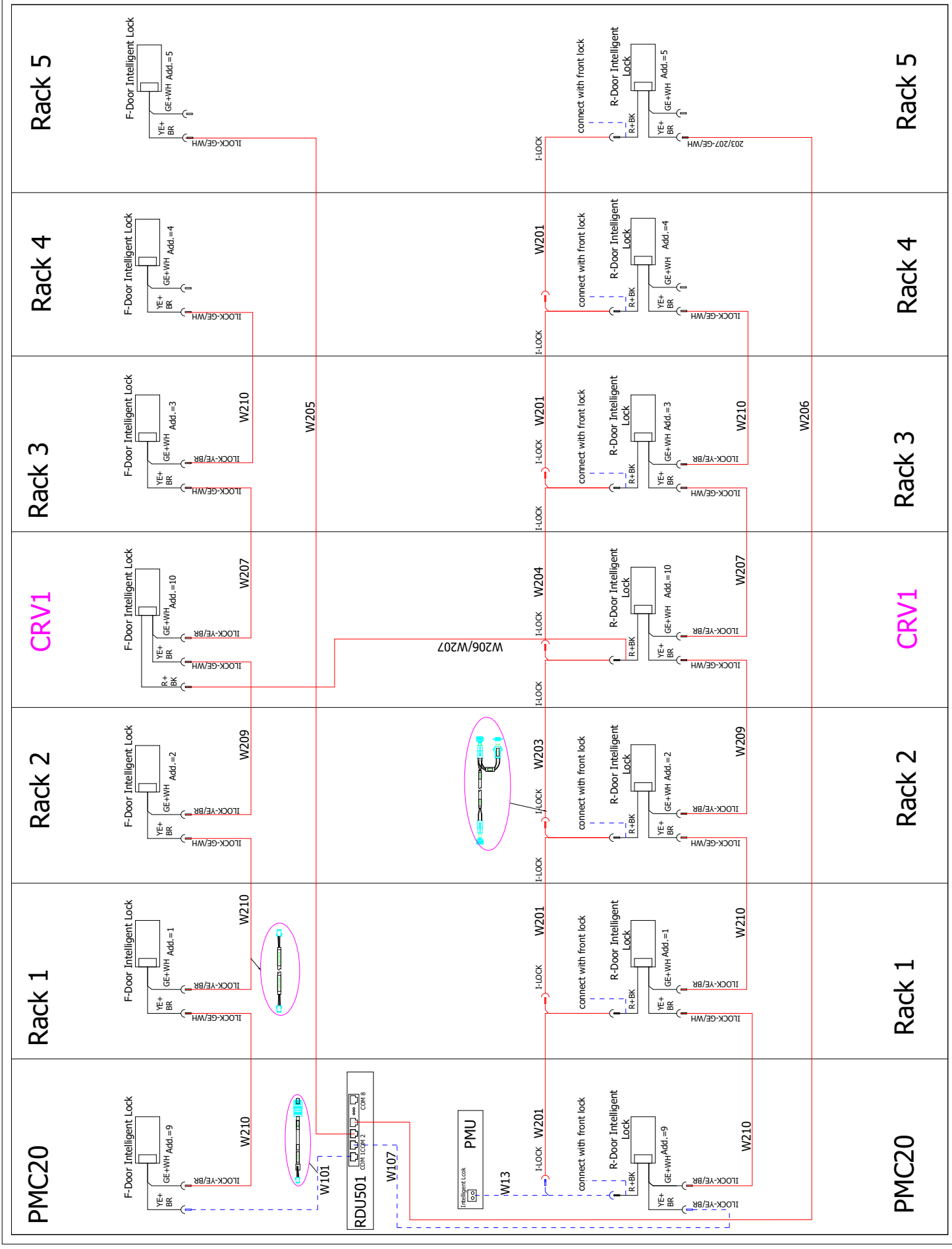

--- Factory connected cables
 --- Cables connected at assembly

0	1	2	3	4	5	6	7	8	9
A	PMC20	Rack 1	Rack 2	CRV1	Rack 3	Rack 4	Rack 5		
B									
C									
D									
E	PMC20	Rack 1	Rack 2	CRV1	Rack 3	Rack 4	Rack 5		

SHEET NO. 10 / 15	DRAWN BY: Nilesch Patil	DWG NO. SR2N05020NAA1
CHANGE NO.	APPROVED BY: Jakub Fencel	DATE (LATEST REV.)
PAGE DESCRIPTION: 4.b- Intelligent lock wiring diagram	TITLE / DESCRIPTION: Vertiv™ SmartRow™ 2: 5x IT Rack 20kW	REVISION: 505 N. CLEVELAND AVE WESTERVILLE OH 43081

LED & Microswitch -SR2 for 20K (5*ITRack)

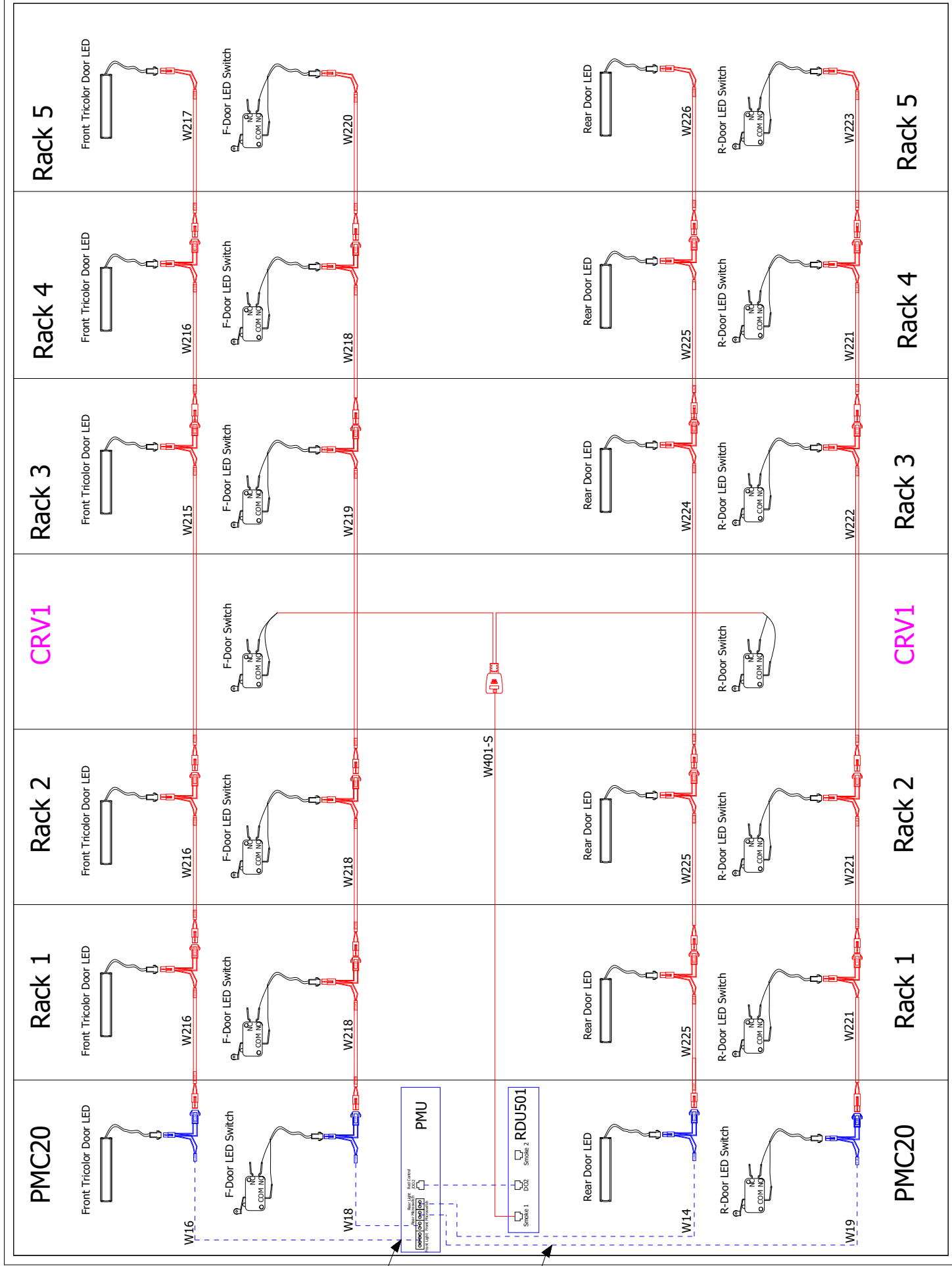

--- Factory connected cables
 --- Cables connected at assembly

SHEET NO. 11 / 15	DRAWN BY: Nilesch Patil	DWG NO. SR2N05020NAA1	
CHANGE NO.	APPROVED BY: Jakub Fencel	DATE (LATEST REV.)	
PAGE DESCRIPTION: 4-c- LED&Micro Switch wiring diagram	TITLE / DESCRIPTION: Vertiv™ SmartRow™ 2: 5x ITRack 20kW		REVISION: 505 N. CLEVELAND AVE WESTERVILLE OH 43081

Fans & THDs -SR2 for 20K (5*ITRack)

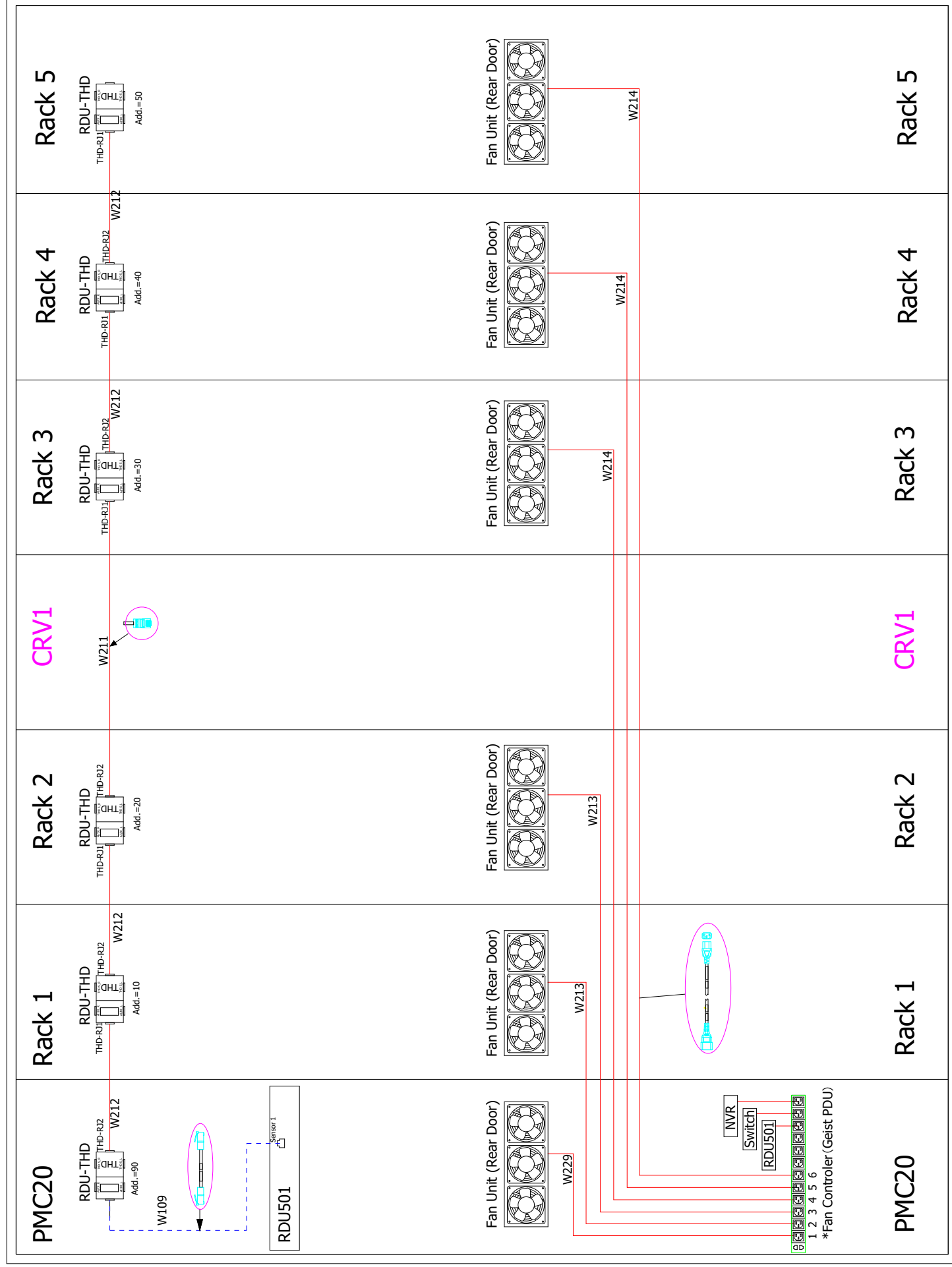

Note :- *Fan controller positions 1 to 6 reserved for emergency fans.

SHEET NO.	12 / 15	DRAWN BY:	Nilesh Patil
CHANGE NO.		APPROVED BY:	Jakub Fencel
PAGE DESCRIPTION:	4.d- THD& Emergency Fan wiring diagram		
DWG NO. SR2N05020NAA1		DATE (LATEST REV.)	
REVISION:		505 N. CLEVELAND AVE WESTERVILLE OH 43081	
TITLE / DESCRIPTION:		Vertiv™ SmartRow™ 2: 5x IT Rack 20kW	
© 2020 VERTIV GROUP CORPORATION. CONFIDENTIAL AND PROPRIETARY. ALL RIGHTS RESERVED. VERTIV AND THE VERTIV LOGO ARE TRADEMARKS OR REGISTERED TRADEMARKS OF VERTIV GROUP CORPORATION. THIS DOCUMENT (AND THE INFORMATION IT CONTAINS) ARE THE PROPERTY OF VERTIV GROUP CORPORATION BY ACCEPTING IT INTO YOUR POSSESSION, YOU AGREE THAT YOU WILL KEEP THIS DOCUMENT AND ALL INFORMATION CONTAINED HEREIN IN STRICTEST CONFIDENCE AND WILL NOT COPY, REPRODUCE, TRANSMIT, USE (EXCEPT FOR THE BENEFIT OF VERTIV GROUP CORPORATION), SELL, LEND, OR OTHERWISE DISPOSE OF SAME, DIRECTLY OR INDIRECTLY, WITHOUT THE EXPRESS WRITTEN PERMISSION, AND THIS DOCUMENT SHALL BE RETURNED TO VERTIV GROUP CORPORATION IMMEDIATELY UPON REQUEST.			

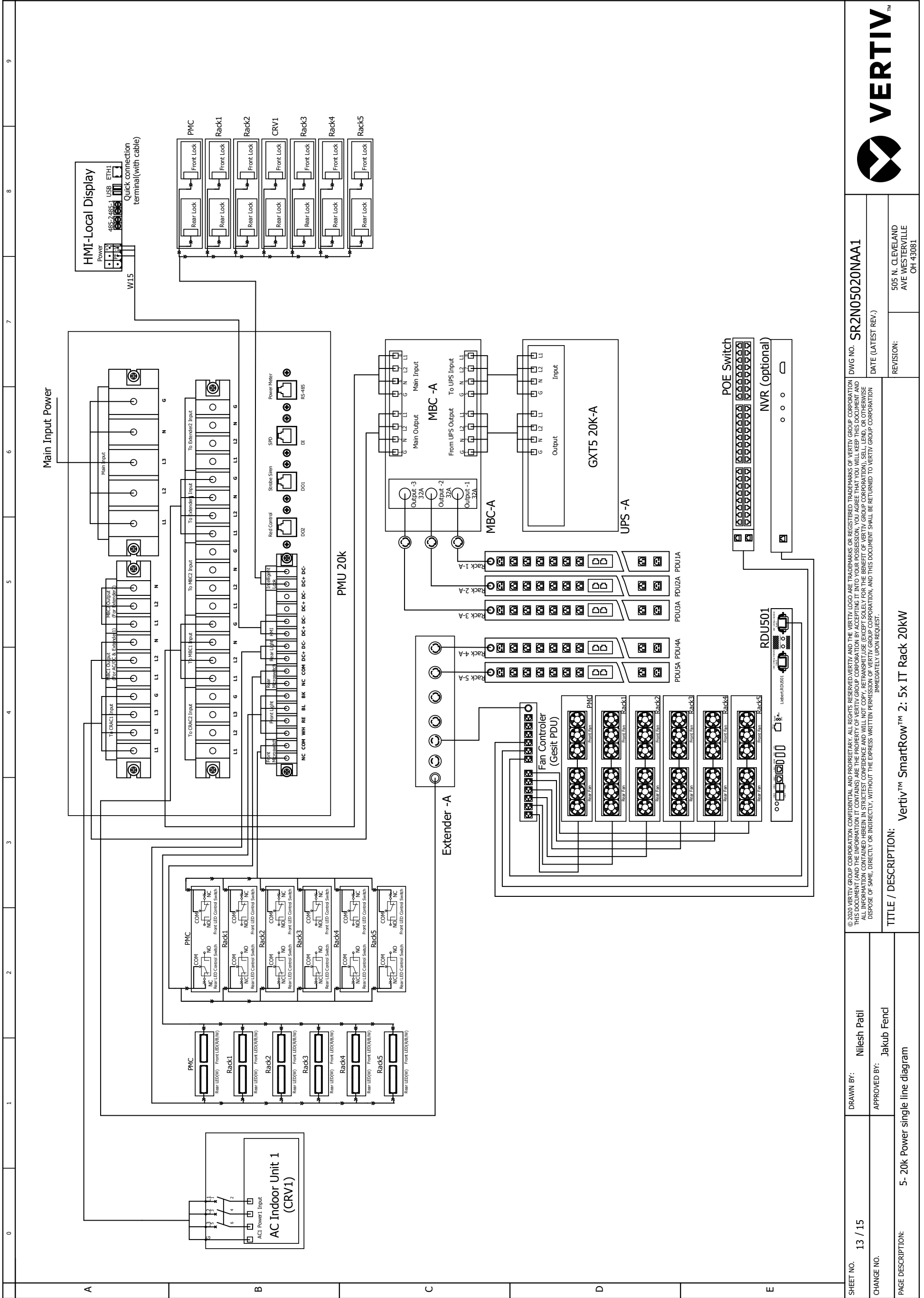

SHEET NO. 13 / 15	DRAWN BY: Nilesh Patil	© 2024 VERTIV GROUP CORPORATION. CONFIDENTIAL AND PROPRIETARY. ALL RIGHTS RESERVED. VERTIV AND THE VERTIV LOGO ARE TRADEMARKS OR REGISTERED TRADEMARKS OF VERTIV GROUP CORPORATION. THIS DOCUMENT AND THE INFORMATION IT CONTAINS ARE THE PROPERTY OF VERTIV GROUP CORPORATION BY ACCEPTING IT INTO YOUR POSSESSION, YOU AGREE THAT YOU WILL KEEP THIS DOCUMENT AND ALL INFORMATION CONTAINED HEREIN IN STRICTEST CONFIDENCE AND WILL NOT COPY, REPRODUCE, REUSE (EXCEPT SOLELY FOR THE BENEFIT OF VERTIV GROUP CORPORATION), SELL, LEND, OR OTHERWISE DISPOSE OF SAME, DIRECTLY OR INDIRECTLY, WITHOUT THE EXPRESS WRITTEN PERMISSION OF VERTIV GROUP CORPORATION, AND THIS DOCUMENT SHALL BE RETURNED TO VERTIV GROUP CORPORATION IMMEDIATELY UPON REQUEST.	DWG NO. SR2N05020NAA1	
CHANGE NO.	APPROVED BY: Jakub Fend		DATE (LATEST REV.)	
PAGE DESCRIPTION: 5- 20k Power single line diagram	TITLE / DESCRIPTION: Vertiv™ SmartRow™ 2: 5x IT Rack 20kW		REVISION: 505 N. CLEVELAND AVE WESTERVILLE OH 43081	

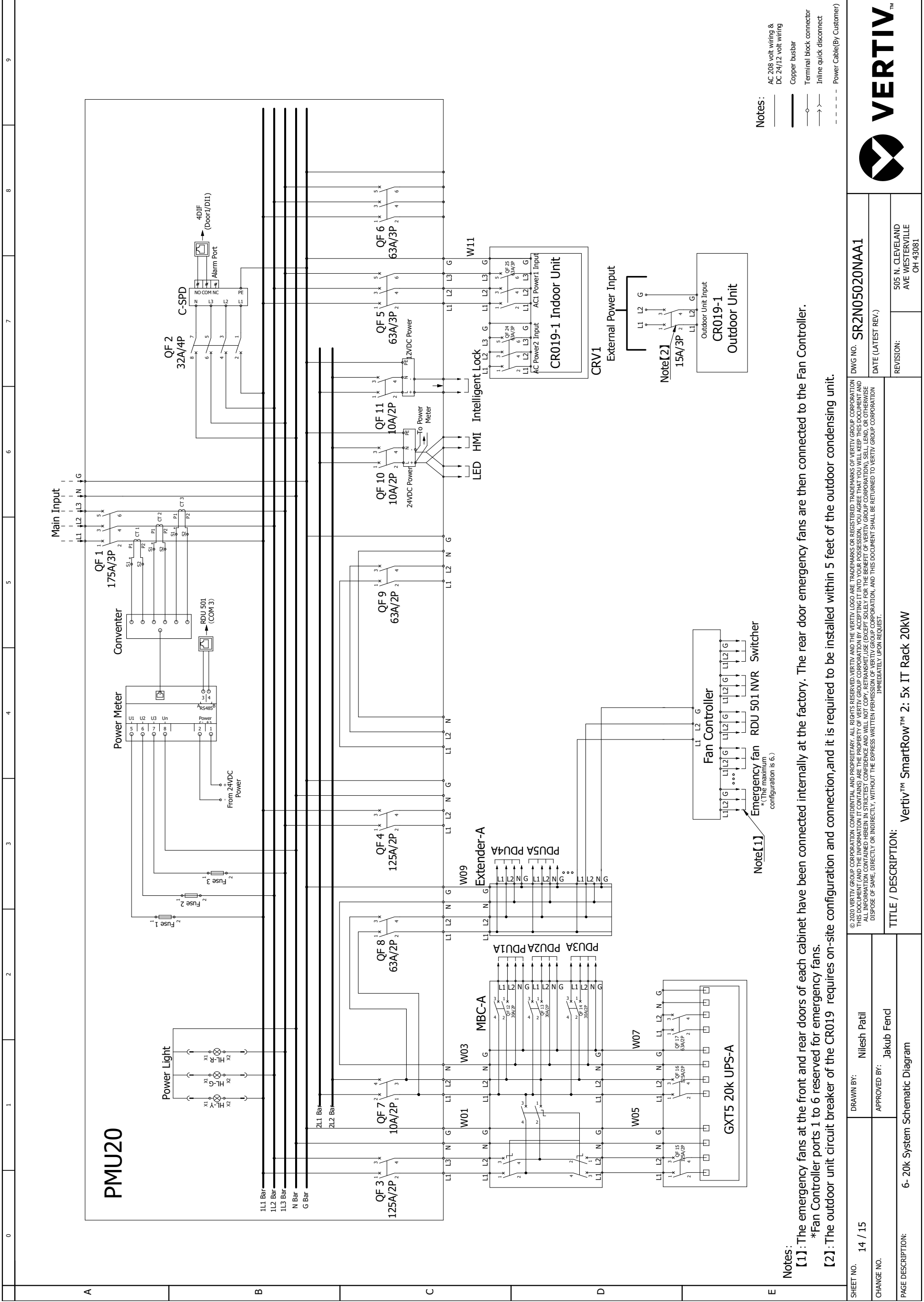

- Notes:**
- AC 208 volt wiring & DC 24/12 volt wiring
 - Copper busbar
 - Terminal block connector
 - Inline quick disconnect
 - Power Cable(By Customer)

Notes:

[1]: The emergency fans at the front and rear doors of each cabinet have been connected internally at the factory. The rear door emergency fans are then connected to the Fan Controller.
 *Fan Controller ports 1 to 6 reserved for emergency fans.

[2]: The outdoor unit circuit breaker of the CR019 requires on-site configuration and connection, and it is required to be installed within 5 feet of the outdoor condensing unit.

SHEET NO. 14 / 15	DRAWN BY: Nilesh Patil	DWG NO. SR2N05020NAA1
CHANGE NO.	APPROVED BY: Jakub Fendl	DATE (LATEST REV.)
PAGE DESCRIPTION: 6- 20k System Schematic Diagram	TITLE / DESCRIPTION: Vertiv™ SmartRow™ 2: 5x IT Rack 20kW	REVISION: 505 N. CLEVELAND AVE WESTERVILLE OH 43081

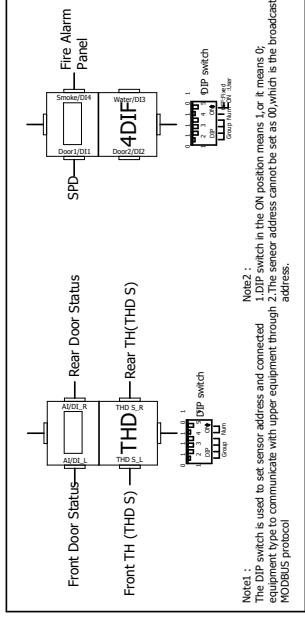
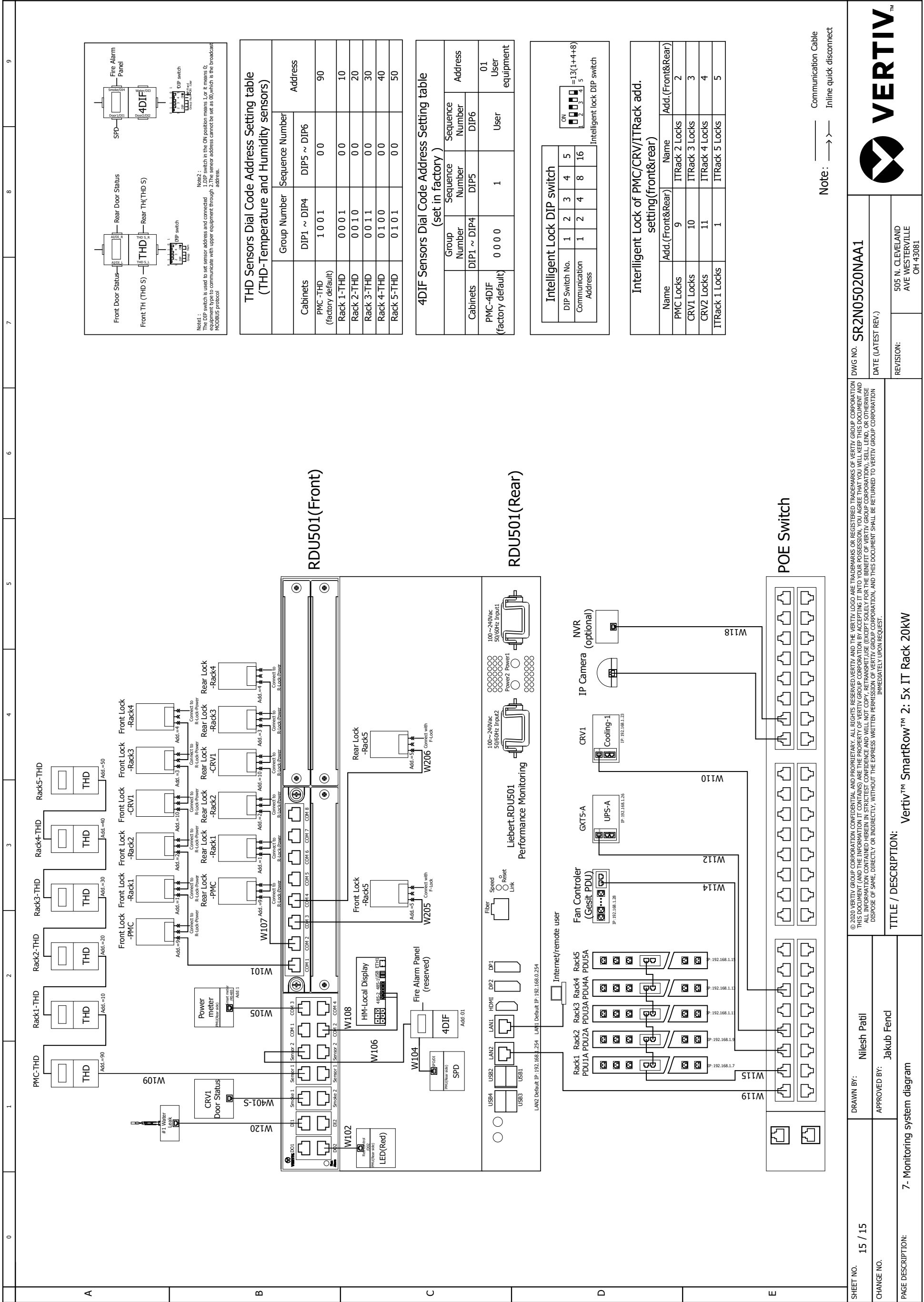

THD Sensors Dial Code Address Setting table (THD-Temperature and Humidity sensors)

Cabinets	Group Number	Sequence Number	Address
PMC-THD (factory default)	DIP1 ~ DIP4	DIP5 ~ DIP6	
Rack 1-THD	1 0 0 1	0 0	90
Rack 2-THD	0 0 0 1	0 0	10
Rack 3-THD	0 0 1 0	0 0	20
Rack 4-THD	0 0 1 1	0 0	30
Rack 5-THD	0 1 0 0	0 0	40
Rack 5-THD	0 1 0 1	0 0	50

4DIF Sensors Dial Code Address Setting table (set in factory)

Group Number	Sequence Number	Address
DIP1 ~ DIP4	DIP5	DIP6
0 0 0 0	1	User equipment
0 0 0 0	0 1	User equipment

Intelligent Lock DIP switch

DIP Switch No.	1	2	3	4	5
Communication Address	1	2	4	8	16

Intelligent lock DIP switch

Interelligent Lock of PMC/CRV/ITRack add. setting (front&rear)

Name	Addr. (Front&Rear)	Name	Addr. (Front&Rear)
PMC Locks	9	ITRack 2 Locks	2
CRV1 Locks	10	ITRack 3 Locks	3
CRV2 Locks	11	ITRack 4 Locks	4
ITRack 1 Locks	1	ITRack 5 Locks	5

Note: ———>——>——> Communication Cable
 ———>——>——> Inline quick disconnect

SHEET NO.	15 / 15	DRAWN BY:	Nilesh Patil	DWG NO.	SR2N05020NAA1
CHANGE NO.		APPROVED BY:	Jakub Fend	DATE (LATEST REV.)	
PAGE DESCRIPTION:	7- Monitoring system diagram	TITLE / DESCRIPTION:		REVISION:	505 N. CLEVELAND AVE WESTERVILLE OH 43081

Vertiv™ SmartRow™ 2: 5x IT Rack 20kW

© 2024 VERTIV GROUP CORPORATION. CONFIDENTIAL AND PROPRIETARY. ALL RIGHTS RESERVED. VERTIV AND THE VERTIV LOGO ARE TRADEMARKS OR REGISTERED TRADEMARKS OF VERTIV GROUP CORPORATION. THIS DOCUMENT AND THE INFORMATION IT CONTAINS ARE THE PROPERTY OF VERTIV GROUP CORPORATION. BY ACCEPTING IT INTO YOUR POSSESSION, YOU AGREE THAT YOU WILL KEEP THIS DOCUMENT AND ALL INFORMATION CONTAINED HEREIN IN STRICTEST CONFIDENCE AND WILL NOT COPY, REPRODUCE, OR OTHERWISE DISCLOSE IT TO ANY OTHER PERSON OR ENTITY WITHOUT THE EXPRESS WRITTEN PERMISSION OF VERTIV GROUP CORPORATION. THIS DOCUMENT SHALL BE RETURNED TO VERTIV GROUP CORPORATION IMMEDIATELY UPON REQUEST.

4. Field Supplied Cable & Part List

0	1	2	3	4	5	6	7	8	9
A	FIELD SUPPLIED CABLE & PART LIST								
PART	DETAILS								
CABbus cable (A)	2 conductors, 22-18AWG shielded cable								
HEAT REJECTION INTERLOCK (B)	2 conductors, 18AWG or greater								
CONDENSER INPUT POWER CABLE (C)	3 conductors + PE, 14 AWG copper cable								
CONDENSATE PUMP TUBE (D)	Used with 3/8 in. nylon adapter hose or 1/2 in. MPT x 3/8 in. hose barb threaded adapter								
B	<p style="text-align: center;">CONNECTION DETAILS REFER TO DPN003036</p>								
C	<p style="text-align: center;">DETAILS REFER TO SL-11975</p>								
D	<p style="text-align: center;">DETAILS REFER TO SL-11975</p>								
E	<p style="text-align: center;">© 2020 VERTIV GROUP CORPORATION. CONFIDENTIAL AND PROPRIETARY. ALL RIGHTS RESERVED. VERTIV AND THE VERTIV LOGO ARE TRADEMARKS OR REGISTERED TRADEMARKS OF VERTIV GROUP CORPORATION. THIS DOCUMENT (AND THE INFORMATION IT CONTAINS) ARE THE PROPERTY OF VERTIV GROUP CORPORATION BY ACCEPTING IT INTO YOUR POSSESSION, YOU AGREE THAT YOU WILL KEEP THIS DOCUMENT AND ALL INFORMATION CONTAINED HEREIN IN STRICTEST CONFIDENCE AND WILL NOT COPY, REPRODUCE, TRANSMIT, USE (EXCEPT SOLELY FOR THE BENEFIT OF VERTIV GROUP CORPORATION), SELL, LEND, OR OTHERWISE DISPOSE OF SAME, DIRECTLY OR INDIRECTLY, WITHOUT THE EXPRESS WRITTEN PERMISSION OF VERTIV GROUP CORPORATION, AND THIS DOCUMENT SHALL BE RETURNED TO VERTIV GROUP CORPORATION IMMEDIATELY UPON REQUEST.</p> <p style="text-align: center;">FIELD SUPPLIED CABLE & PART LIST</p>								
SHEET NO. 1 / 1	DRAWN BY: Petr Harant		DWG NO.		DATE (LATEST REV.) 30.05.2024				
CHANGE NO.	APPROVED BY: Tomáš Krech		REVISION:		505 N. CLEVELAND AVE. WESTERVILLE OH 43081				
PAGE DESCRIPTION:	FIELD SUPPLIED CABLE & PART LIST								

6. Vertiv MSR2 Power Management Cabinet (PMC)

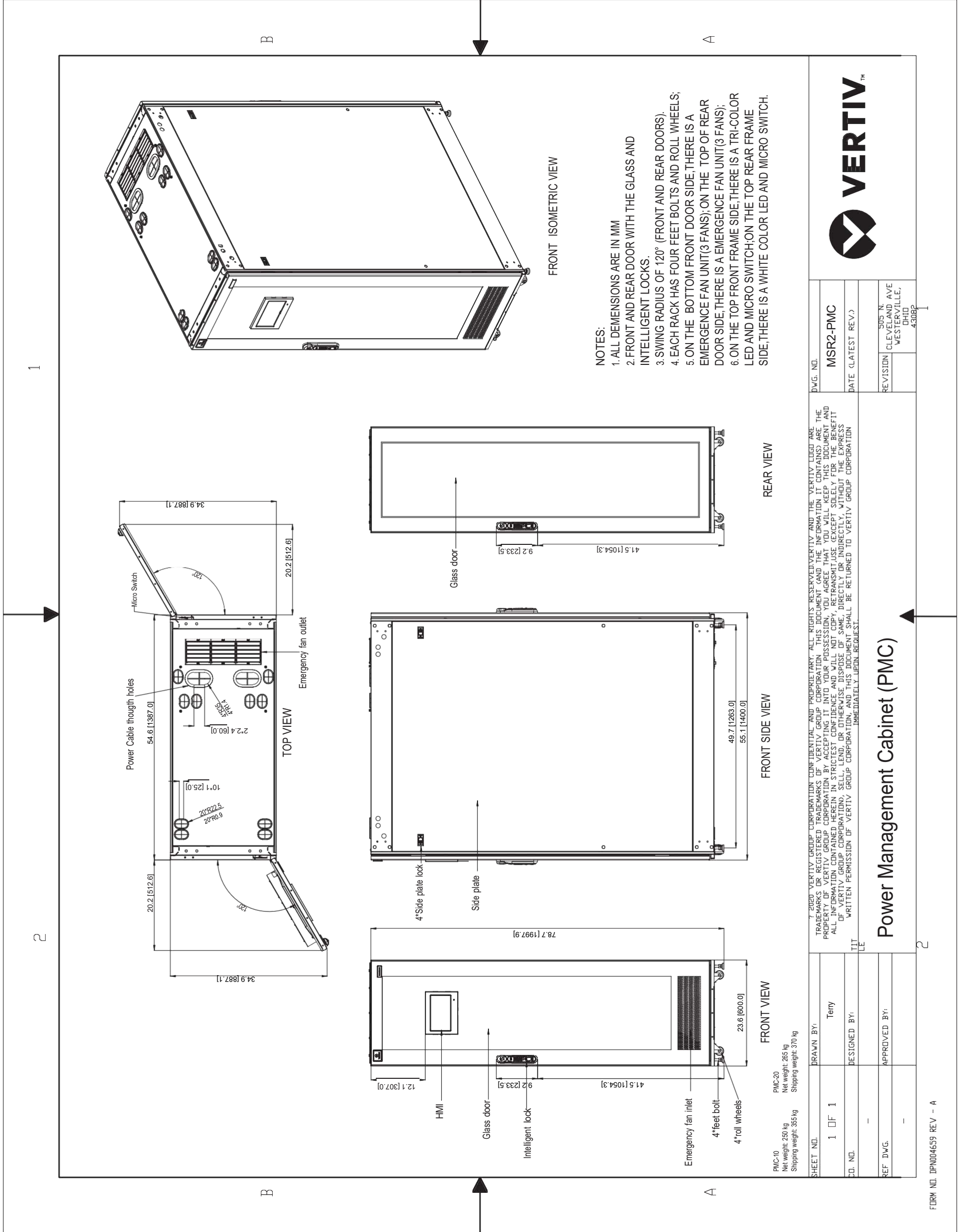

9. PMU20 Terminal Blocks Size

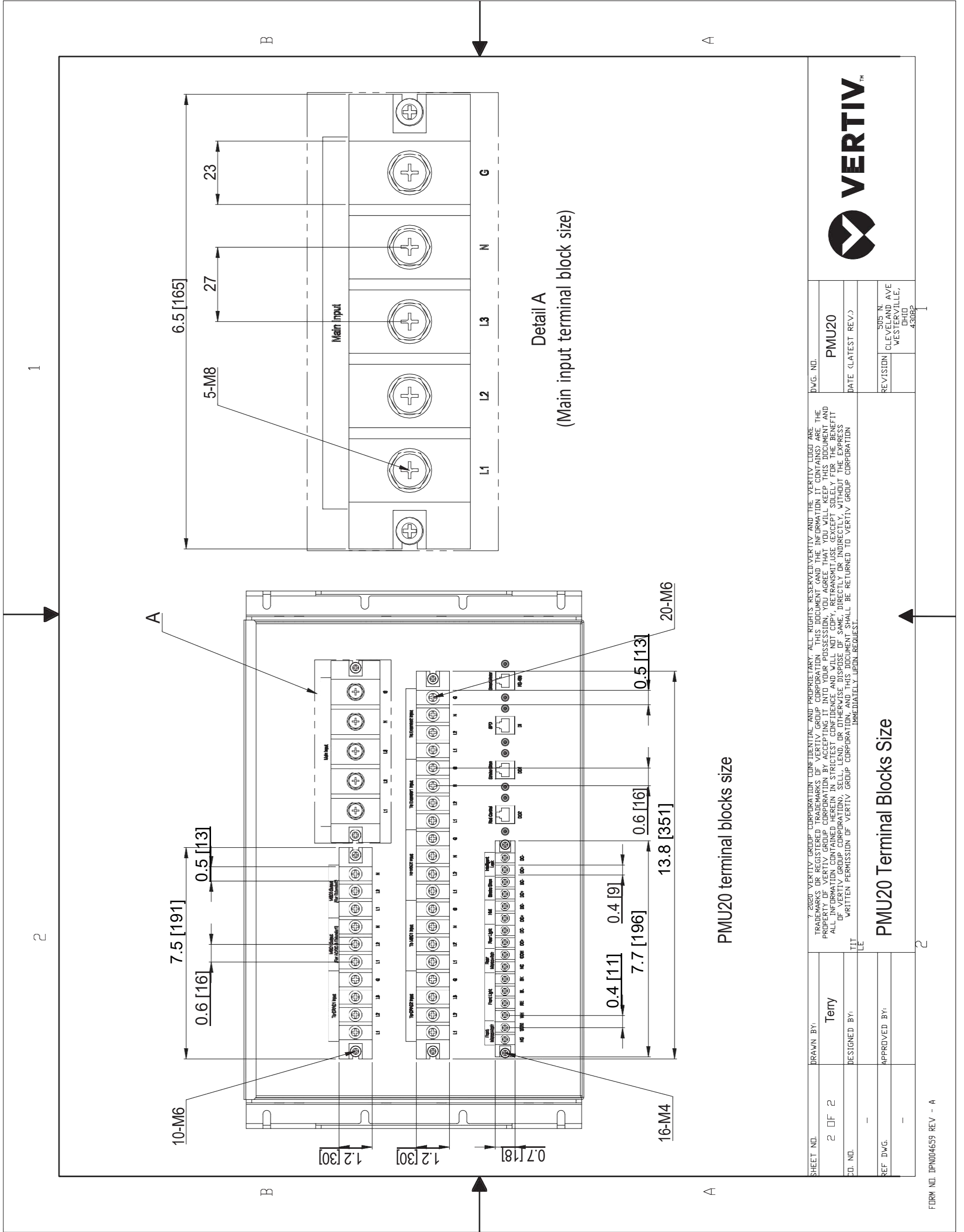

SHEET NO.	2 OF 2	DRAWN BY:	Terry	DWG. NO.	PMU20	
CD. NO.	-	DESIGNED BY:	ITT	DATE (LATEST REV.)		
REF. DWG.	-	APPROVED BY:	LE	REVISION		SUS. N. CLEVELAND AVE WESTERVILLE, OHIO 43082

© 2020 VERTIV GROUP CORPORATION. CONFIDENTIAL AND PROPRIETARY. ALL RIGHTS RESERVED. VERTIV AND THE VERTIV LOGO ARE TRADEMARKS OR REGISTERED TRADEMARKS OF VERTIV GROUP CORPORATION. THIS DOCUMENT (AND THE INFORMATION IT CONTAINS) ARE THE PROPERTY OF VERTIV GROUP CORPORATION. BY ACCEPTING IT INTO YOUR POSSESSION, YOU AGREE THAT YOU WILL KEEP THIS DOCUMENT AND ALL INFORMATION CONTAINED HEREIN IN STRICTEST CONFIDENCE AND WILL NOT COPY, REPRODUCE, TRANSMIT, USE (EXCEPT SOLELY FOR THE BENEFIT OF VERTIV GROUP CORPORATION), SELL, LEND, OR OTHERWISE DISPOSE OF SAME, DIRECTLY OR INDIRECTLY, WITHOUT THE EXPRESS WRITTEN PERMISSION OF VERTIV GROUP CORPORATION, AND THIS DOCUMENT SHALL BE RETURNED TO VERTIV GROUP CORPORATION IMMEDIATELY UPON REQUEST.

PMU20 Terminal Blocks Size

10. Vertiv MSR2 – CT300 Cable Tray 300mm

1
2

B
A

B
A

1
2

B
A

1
2

B
A

1
2

B
A

1
2

B
A

1
2

B
A

1
2

B
A

1
2

B
A

1
2

B
A

1
2

B
A

1
2

B
A

1
2

B
A

1
2

B
A

1
2

B
A

1
2

B
A

1
2

B
A

1
2

B
A

1
2

B
A

1
2

B
A

1
2

B
A

1
2

B
A

1
2

B
A

1
2

B
A

1
2

B
A

1
2

B
A

1
2

B
A

1
2

B
A

1
2

B
A

1
2

B
A

1
2

B
A

1
2

B
A

1
2

B
A

1
2

B
A

1
2

B
A

1
2

B
A

1
2

B
A

1
2

B
A

1
2

B
A

1
2

B
A

1
2

B
A

1
2

B
A

1
2

B
A

1
2

B
A

1
2

B
A

1
2

B
A

1
2

B
A

1
2

B
A

1
2

B
A

1
2

B
A

1
2

B
A

1
2

B
A

1
2

B
A

1
2

B
A

1
2

B
A

1
2

B
A

1
2

B
A

1
2

B
A

1
2

B
A

1
2

B
A

1
2

B
A

1
2

B
A

1
2

B
A

1
2

B
A

1
2

B
A

1
2

B
A

1
2

B
A

1
2

B
A

1
2

B
A

1
2

B
A

1
2

B
A

1
2

B
A

1
2

B
A

1
2

B
A

1
2

B
A

1
2

B
A

1
2

B
A

1
2

B
A

1
2

B
A

1
2

B
A

1
2

B
A

1
2

B
A

1
2

B
A

1
2

B
A

1
2

B
A

1
2

B
A

1
2

B
A

1
2

B
A

1
2

B
A

1
2

B
A

1
2

B
A

1
2

B
A

1
2

B
A

1
2

B
A

1
2

B
A

1
2

B
A

1
2

B
A

1
2

B
A

1
2

B
A

1
2

B
A

1
2

B
A

1
2

B
A

1
2

B
A

1
2

B
A

1
2

B
A

1
2

B
A

1
2

B
A

1
2

B
A

1
2

B
A

1
2

B
A

1
2

B
A

1
2

B
A

1
2

B
A

1
2

B
A

1
2

B
A

1
2

B
A

1
2

B
A

1
2

B
A

1
2

B
A

1
2

B
A

1
2

B
A

1
2

B
A

1
2

B
A

1
2

B
A

1
2

B
A

1
2

B
A

1
2

B
A

1
2

B
A

1
2

B
A

1
2

B
A

1
2

B
A

1
2

B
A

1
2

B

11. Vertiv MSR2 - CT600 Cable Tray 600mm

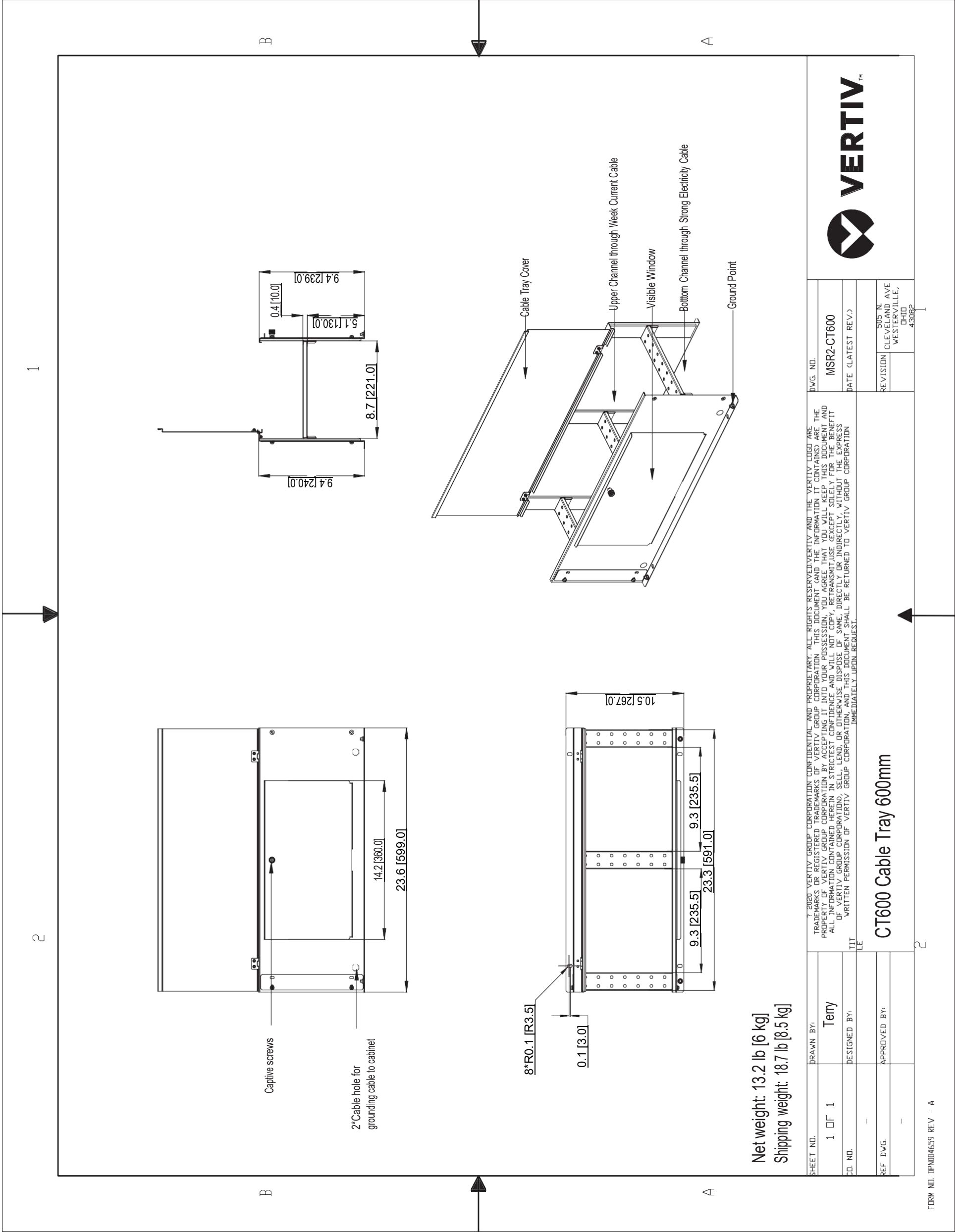

DWG. NO.	MSR2-CT600
REVISION	DATE (LATEST REV.)
505 N. CLEVELAND AVE. WESTERVILLE, OHIO 43082	
© 2020 VERTIV GROUP CORPORATION. ALL RIGHTS RESERVED. VERTIV AND THE VERTIV LOGO ARE TRADEMARKS OR REGISTERED TRADEMARKS OF VERTIV GROUP CORPORATION. THIS DOCUMENT (AND THE INFORMATION IT CONTAINS) ARE THE PROPERTY OF VERTIV GROUP CORPORATION. BY ACCEPTING IT INTO YOUR POSSESSION, YOU AGREE THAT YOU WILL KEEP THIS DOCUMENT AND ALL INFORMATION CONTAINED HEREIN IN STRICT CONFIDENCE AND WILL NOT COPY, REPRODUCE, TRANSMIT, USE (EXCEPT SOLELY FOR THE BENEFIT OF VERTIV GROUP CORPORATION), SELL, LEND, OR OTHERWISE DISPOSE OF SAME, DIRECTLY OR INDIRECTLY, WITHOUT THE EXPRESS WRITTEN PERMISSION OF VERTIV GROUP CORPORATION, AND THIS DOCUMENT SHALL BE RETURNED TO VERTIV GROUP CORPORATION IMMEDIATELY UPON REQUEST.	
DRAWN BY: Terry DESIGNED BY: APPROVED BY:	
SHEET NO.	1 OF 1
CD. NO.	
REF. DWG.	

12. Scope of Work

SmartRow2 Assembly

SERVICE SUMMARY

Feature	Detail
On-Site Service	Site trip(s) within the 48 contiguous states. Visit(s) to be scheduled by the customer between 7 am-5 pm, Monday-Friday (excluding weekends & national holidays).
Customer Support	Includes access to the Customer Resolution Center (1-800-543-2378) and the Vertiv Customer Services Network Online Internet portal for extent of product warranty.
Consolidation	The SmartRow2 includes numerous shippable units (typically pallets or boxes) that originate from multiple factories and suppliers. Vertiv consolidates these items into a single customer shipment and reduces the likelihood of shippable units being lost at the customer site. This benefits the customer by relieving the burden of keeping track of multiple partial shipments.
Inside Delivery	Vertiv Service will move the shippable units from the delivery truck to the Staging Area. Vertiv Services will unpackage the shippable units and remove/dispose of the packaging material so that it is ready for assembly. Vertiv will verify that all material on the sales order has been received.
Project Management	Included with Consolidation and Inside Delivery. Vertiv will assign a project manager for the project. The Project Manager will supervise the Consolidation and Inside Delivery Process and communicate hardware shipment schedules with the customer.
Assembly	SmartRow2 is assembled onsite by Vertiv factory-trained and authorized technicians equipped with Vertiv Proprietary tools and software. Vertiv CEs and Vertiv Partners are the only approved OEM service providers for Vertiv products. These technicians are supervised by a Site Manager who also gathers site-specific requirements like safety and work procedures
Factory Startup	Warranty inspection and startup validates the warranty and initializes the warranty coverage period

SERVICE PERFORMED

Consolidated Shipment

Shippable units may be available at time of order or built-to-order with a lead time. Vertiv safely stores these items in-warehouse until the customer is ready to receive the SmartRow2 in a single shipment

Inside Delivery

Vertiv Services will deliver the shippable units from the delivery truck to the Staging Area. Vertiv Services will unpackage the shippable units and remove/dispose of the packaging material so that it is ready for assembly. Vertiv will verify that all material has been received.

Change order option:

- There must be an appropriate loading dock with continuous, level floor from the dock to the staging area. If the shippable units must be moved up/down stairs, the customer must provide a suitable elevator, or charges for special rigging will be incurred. If the customer does not have an appropriate loading dock, nominal charges may/may-not apply for a lift-truck delivery.

Project Management

Vertiv will assign a project manager and a site manager for the project.

The Project Manager will supervise the Consolidation and Inside Delivery Process and communicate schedules with the customer. The Site Manager will supervise the assembly, startup, warranty inspection and turn over the

Site-Specific Requirements

All personnel will be available for up to two hours per week for Site Access, Safety Training and other site-specific requirements Change Order Option:

- Vertiv can quote a price for additional man-hours if 2 hours per week is insufficient

Assembly

There shall be continuous, level floor between the Staging Area and the Installation Location so that heavy items can be moved via casters/pallet jacks.

Change Order Option:

- If there is not continuous level floor, the customer must provide or pay for any necessary lift/rigging equipment.

Project Management

Vertiv PMC, including RDU501 SmartRow2 Controller/Display

Vertiv will position, level, and bay together the PMC as described in the submittal documents.

The customer is responsible for providing primary electrical power to the PMC.

Vertiv will program and configure the SmartRow2 RDU501 controller/display. This includes setting IP addresses so that the customer can monitor the system status remotely

Change Order Option:

- Vertiv will quote IP addressing of equipment on the customer network, but this would be done by other personnel and scheduled separately. This is outside the scope of SmartRow2 assembly.

Vertiv IT Rack(s)

Vertiv will position, level, and bay together the Vertiv IT Racks as described in the submittal documents. Vertiv will not populate racks with customer IT gear, including blanking panels, servers, shelves, etc.

The customer must define addressing conventions (1,2,3,4, right-to-left or left-to-right) prior to start of work.

Cable Trays

Vertiv will install the SmartRow2 cable trays that are included with the SmartRow2 solution as described in the submittal documents

Liebert®CRV's, Temperature Sensors, Modbus cables, and associated Plenums

Vertiv will position and level the Liebert® CRV and attach the associated plenums to provide cooling to the SmartRow2.

Vertiv will connect the necessary temperature sensors.

The customer is responsible for piping and primary power to the CRV along with connecting CANBus cable between the CRV and heat rejection. All specific requirements (such as piping traps and proper electrical grounding) for correct product installation are detailed in the product installation manual.

After the SmartRow2 is assembled and the Liebert® CRV is piped and powered by the customer in accordance with the product installation manual, Vertiv will perform a factory warranty inspection along with the rest of the SmartRow2

Liebert®MC / CCD Condensers for Liebert®CRV's

The customer is responsible for installing the associated heat rejection. This includes primary power, CANBus communication wire, piping, refrigerant charging, and all other tasks in the Installation Manual. Any/all penetration points in the walls/ceilings/floors for any wiring or piping are also the customer's responsibility.

Rack PDUs

Vertiv will install and connect all rack PDUs (if applicable) including GXT5 power extensions (if applicable) as described in the submittal documents

Liebert®GXT5 Single Phase UPS's

Vertiv will install and connect all Liebert® GXT5 UPS's and connect power within the PMC cabinet and output to the PDUs as described in the submittal documents.

Additionally, Vertiv will install ancillary equipment such as Maintenance bypass and PD2-103 cabling and connectors if not already preinstalled.

After the SmartRow2 is assembled and Primary Power to the SmartRow2 is provided by the customer, Vertiv will perform factory startup of all GXT5 equipment along with the rest of the SmartRow2

Switch

Vertiv will install and connect the switch within the PMC cabinet. as described in the submittal documents

Firmware Updates

Vertiv will update firmware of any/all units to the current revision level. Shippable units are sourced globally and firmware evolves as products may be in stock with prior revisions

Wiring

Vertiv will run all necessary wiring for power and communication between cabinets as part of assembly. This includes setting IP/DIP switch settings for proper communication between the device and the PMC

Accessories

The SmartRow2 is available with lights, door locks/sensors, temperature sensors that Vertiv will connect and install.

Services associated with cameras are sold separately and out-of-scope for the SmartRow2 Assembly

RDU Monitor SmartRow2 mobile application

Services associated with the RDU Monitor SmartRow2 mobile applications are quoted separately and out-of-scope for SmartRow2 assembly

ASSUMPTIONS AND CLARIFICATIONS

- Vertiv start-up validates product warranty.
- Defects or damage resulting from installation not performed by Vertiv are not covered.
- Parts and Labor coverage is in accordance with Product Warranty. If a modified warranty is purchased, terms default to that specific package.
- Any customer site visit is limited to eight (8) hours per visit. Any time beyond forty (40) hours/wk or eight (8) hrs/day or additional Startup visits will be billed separately.
- Expenses incurred due to delays that are beyond the control of Vertiv may be billed at cost.
- Startup visit must be scheduled confirmation of proper installation (if Vertiv not involved with installation).
- This pricing excludes any load bank testing. This can also be quoted separately if required.
- Pricing excludes activities associated with 3rd party commissioning
- Pricing excludes any type of circuit breaker NEMA testing. This can also be quoted separately if required.
- Customer/Installing contractor is responsible for providing elevated access as necessary.
- Any additional requests beyond the scope of this document will be billed separately by Vertiv.
- Vertiv will not perform physical changes to the site building (such as drilling holes, etc.)

CUSTOMER RESPONSIBILITIES

In order to provide timely, accurate and thorough execution of the services described herein, Vertiv requests the following:

- Point of Contact: Provide an authorized point of contact(s), specific for the scope of work, for scheduling and coordination purposes.
- Scheduling: Make dates available for scheduling service. All visits must be requested 4 weeks in advance for assembly and 10 days for startup/warranty-inspection of need by contacting the Vertiv Project Manager. Site must be available for 5 consecutive business days. Customer may choose to pay for premium time if weekend work is necessary.
- Site Access: Prior to time of scheduled work, provide site access including any customer required escort, security clearance, safety training and badging for Vertiv personnel.
- Equipment Access: Convenient access to the equipment covered by the Scope of Work. Prior to scheduled time of work, notify Vertiv personnel of any special requirements for equipment access including lifts, ladders, etc.
- Shutdown: Service may require shutdown of load to ensure electrical connection integrity.
- Notification: If for any reason the work cannot be performed during scheduled time, notify Vertiv personnel 24-hours prior to scheduled event.
- Provide Method of Procedure (MOP) requirements/ templates, and required review period(s)

TERMS AND CONDITIONS

Subject to all Terms & Conditions as noted in the Vertiv Terms & Conditions or the terms of a Master Agreement between the parties, if any, shall apply.



SmartRow 2 Scope of Work Checklist

Customer Name: _____

Project Name: _____

Project Number: _____

This document is to serve as a checklist to help identify and budget the various work activities involved with assembling and installing a SmartRow 2. It is the customers responsibility to ensure all tasks are assigned to partners which will result in a successful SmartRow 2 project.

Contact Vertiv for available local support resources to provide technical guidance as needed. Call 800 543-2378

The **X** indicates the responsible party for that task. Multiple **X**'s indicate shared responsibility.

This document is provided as a reference document and does not replace any product manuals or supporting documentation. Always read all product documentation before performing any work.

Customer (Name) *includes responsibility for Mechanical, Electrical, and/or General Contractors as needed* : _____

Project Management: _____

Assembly Team Lead: _____

Consolidator: _____

Vertiv Warranty Inspection Tech: _____

Vertiv Sales Rep (LVO): _____

