

Emerson Network Power® MPH2™ Rack PDU

User Manual



Table of Content

Important Safety Instructions	1
Safety Symbols	3
1.0 Introduction	4
1.1 General Characteristics	6
1.2 Model Types	7
1.3 Appearance and Components	7
1.3.1 Controls and Indicators—RPC2™	7
1.3.2 LED Indicators	8
1.3.3 On-board LCD Controls and Indicators	8
1.3.4 Power Components	8
1.3.4.1 Branch Overcurrent Protection	9
1.3.5 Hard-Wired Connection Features	10
2.0 Installation	11
2.1 Attaching Input Power Cords—Hard-wired Models Only	11
2.1.1 Attaching Input-power Cords without Conduit	11
2.1.2 Attaching Input-power Cords with Conduit	12
2.2 Tool-less Mounting	14
2.3 Installing a MPH2 in an Emerson® Rack	15
2.3.1 Mounting Hardware and Tools Required	15
2.3.2 Mounting the Vertical MPH2	15
2.3.3 Mounting the Horizontal MPH2	16
2.3.4 Mounting Horizontal MPH2 on Vertical Frame Member with Aluminum Extrusions	17
2.3.5 Rack Grounding strap	18
2.3.6 Recommended Electrical-backup Protection	20
2.4 Connecting Rack Equipment	20
2.5 Installing Optional Items	21
2.5.1 RPC Basic Display Module Installation	21
2.5.1.1 Included Hardware	21
2.5.2 Temperature/Humidity Sensor Installation	23

3.0 Operation	24
3.1 Controls and Indicators	24
3.2 View Input-level Information	25
3.2.1 Communication Link with RPC2	26
3.3 View MPH2 System Information	27
3.3.1 System and Screen Options	27
3.3.2 Reboot the On-board LCD	28
3.3.3 Restore System Defaults	29
3.3.4 Determine IP Address, MAC Address and Firmware Version	32
3.3.5 Adjust the Contrast of the On-board LCD	33
3.3.6 Adjust the Orientation of the On-board LCD	34
3.4 View Active Alarms	34
3.4.1 Silence an Audible Alarm	34
3.5 View Branch-level Information	35
3.6 View Receptacle-level Information	36
3.7 View Sensor Information	38
3.8 Opening and Closing Circuit Breakers	40
4.0 Emerson® MPH2 Rack PDU Specifications	41
5.0 Troubleshooting	42
5.1 Additional Troubleshooting by Plug Type	44

List of Figures

Figure 1-1: Vertical MPH2 Rack PDU Configuration	5
Figure 1-2: Horizontal MPH2 Rack PDU Configuration	6
Figure 1-3: MPH2 major monitoring and management features	7
Figure 1-4: Branch and receptacle identification—Units with no monitoring (Type B models).	8
Figure 1-5: Branch and receptacle identification—Units with individually-monitored and managed receptacles (Type C, R and M models).	9
Figure 1-6: Circuit breaker branch identification	10
Figure 2-1: Disassembly to install an input-power cable	12
Figure 2-2: Re-assembly to install an input power cable in conduit.	13
Figure 2-3: Tool-less mounting.	14
Figure 2-4: Installing vertical MPH2 in an Emerson rack.	16
Figure 2-5: Installing horizontal MPH2 in an Emerson rack.	16
Figure 2-6: Installing horizontal MPH2 in a rack with aluminum extrusions.	17
Figure 2-7: Rack grounding-strap connection	19
Figure 2-8: RPC BDM	22
Figure 2-9: Inserting the spring nut into a T-slot.	22
Figure 3-1: On-board LCD and control keys	24
Figure 3-2: Input-level information (main screen)	25
Figure 3-3: Configuration in-progress wheel	26
Figure 3-4: System information	27
Figure 3-5: System-info and Screen-option icons	27
Figure 3-6: Reboot Options	28
Figure 3-7: Restore Defaults selected on Reboot Options	29
Figure 3-8: Restore Defaults? confirmation	29
Figure 3-9: IP address, MAC address, and firmware information	32
Figure 3-10: Adjust LCD contrast.	33
Figure 3-11: Alarm list	34
Figure 3-12: Branch information	35
Figure 3-13: Receptacle list	36
Figure 3-14: Receptacle information	37
Figure 3-15: Sensor list	38
Figure 3-16: Sensor information	39
Figure 3-17: Turning Off or resetting a circuit breaker	40

List of Tables

Table 2-1: Hard-wired models—Connection terminal ratings	13
Table 2-2: Terminal tightening torque	14
Table 2-3: Ground-strap wire gauge by MPH2 rating	18
Table 2-4: Upstream circuit breaker rating	20
Table 3-1: Factory-default settings	30
Table 5-1: Receptacle LED Troubleshooting	42
Table 5-2: Line LED Troubleshooting	43
Table 5-3: Active Line LEDs and Branch Voltage Phasing by Plug Type	44

Important Safety Instructions

SAVE THESE INSTRUCTIONS

This safety sheet contains important safety instructions. Read all safety, installation and operating instructions before installing the Emerson Network Power MPH2 rack power-distribution unit (PDU). Adhere to all warnings on the unit and in this safety sheet. Follow all instructions.

- The MPH2 Rack PDU is designed for information technology equipment. The MPH2 Rack PDU is not intended for use with life support or other designated critical devices. If uncertain about its intended application, consult your local dealer or Emerson representative.
- Maximum load must not exceed the rating shown on the MPH2 Rack PDU nameplate.
- The rated line voltage must not exceed 240VAC for connection to AC power distribution systems with an isolated or high-impedance ground.
- Operate the MPH2 Rack PDU in an indoor environment only in the appropriate ambient temperature range:
 - 32°F to 140°F (0°C to 60°C) for 24A or less input models.
 - 32°F to 122°F (0°C to 50°C) for 40A and 48A input models without case ventilation.
 - 32°F to 140°F (0°C to 60°C) for 40A and 48A input models with case ventilation.
 - Install the MPH2 Rack PDU in a clean environment, free of conductive contaminants, moisture, flammable liquids, gases and corrosive substances.
- The MPH2 Rack PDU must be installed in a restricted-access location. A restricted-access location is an area where access is possible only through the use of a tool or lock and key or other means of security, and is controlled by the authority responsible for the location.
- The MPH2 Rack PDU has no user-serviceable parts. Under no circumstances attempt to gain internal access due to the risk of electric shock or burn.
- Refer any unexpected behavior or unusual fault conditions to your local dealer, Emerson representative or Emerson Network Power Applications Engineering.
- Emerson recommends powering only devices with safety agency approval from the MPH2 Rack PDU.
- For permanently connected MPH2 Rack PDUs (hard-wired versions), a readily accessible disconnect device must be incorporated external to the equipment.
- For MPH2 Rack PDUs with integral plugs, the socket/ outlet must be installed near the equipment and must be easily accessible.



WARNING

Opening or removing end caps from an MPH2 Rack PDU may expose personnel to lethal voltages within the rack PDU. Observe all cautions and warnings. Failure to do so may result in serious injury or death. MPH2 Rack PDU units contain no user-serviceable parts. For service or technical support, contact Emerson Network Power Applications Engineering or your local Emerson representative. Do not attempt to service this product yourself.



CAUTION

Connecting an MPH2 Rack PDU to a power supply with an incorrect rating in voltage or amperes may damage the connected equipment and your MPH2 Rack PDU. For questions about the power supply connections, contact Emerson Network Power Applications Engineering or your local Emerson representative.



CAUTION

Ensure that the ratings of the electric circuit of each connected device meets the specified rating at each branch and receptacle.

! CAUTION

All configuration steps must be completed before attempting to start equipment connected to the MPH2 Rack PDU.

! NOTE

For power management purposes, record the receptacle where each piece of equipment is connected. Receptacles on the MPH2 Rack PDU have a numeric designation. The MPH2 Rack PDU identifies the receptacles with numbers and are grouped by branch with a letter referring to the proper circuit breaker.

EUROPEAN UNION

Notice to European Union Customers: Disposal of Old Appliances

This product uses components that are dangerous for the environment, such as electronic cards and other electronic components. Any component that is removed must be taken to specialized collection and disposal centers. If this unit must be dismantled, this must be done by a specialized center for collection and disposal of electric and electronics appliances or other dangerous substances. This product has been supplied from an environmentally aware manufacturer that complies with the Waste Electrical and Electronic Equipment (WEEE) Directive 2002/96/EC. The “crossed-out wheellie bin” symbol at right is placed on this product to encourage you to recycle wherever possible.

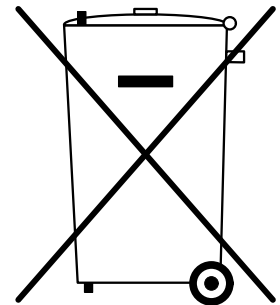

Please be environmentally responsible and recycle this product through your recycling facility at its end of life. Do not dispose of this product as unsorted municipal waste. Follow local municipal waste ordinances for proper disposal provisions to reduce the environmental impact of waste electrical and electronic equipment (WEEE).

For information regarding the scrapping of this equipment, go to <http://www.eu.emersonnetworkpower.com> (“Products session” or “Contact us” session) or call Emerson’s worldwide technical support at:

- 00 80011554499 (toll free number)
- +39 0298250222 (toll number based in Italy)

ROHS Compliance

The MPH2 Rack PDU modules comply with the Restriction of Hazardous Substances directive (ROHS), prohibiting use of six hazardous materials manufacturing of electronics, including lead-free solder.

FCC Compliance

This unit complies with the limits for a Class A device pursuant to Part 15 of the FCC Rules. Operation is subject to the following two conditions:

This device may not cause harmful interference, and

This device must accept any interference received, including interference that may cause undesired operation.







NOTE

This equipment has been tested and found to comply with the limits for a Class A digital device, pursuant to Part 15 of the FCC Rules. These limits are designed to provide reasonable protection against harmful interference when the equipment is operated in a commercial environment. This equipment generates, uses and can radiate radio frequency energy and, if not installed and used in accordance with the instruction manual, may cause harmful interference to radio communications.

Operation of this equipment in a residential area is likely to cause harmful interference that the user must correct, including the expense of all corrective modifications.

Safety Symbols

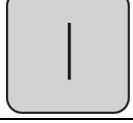
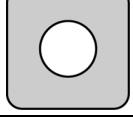
The following symbols may appear within the documentation or on the product.

Symbol	Meaning
	<p>High Temperature Alerts the user where the enclosure temperature may exceed 158°F (70°C) while operating under high-ambient temperature and at maximally rated load.</p>
	<p>Instructions Signifies the presence of important operating and maintenance (servicing) instructions in the literature accompanying the appliance.</p>
	<p>Dangerous Voltage Warns about the presence of uninsulated dangerous voltage within the product's enclosure that may be of sufficient magnitude to constitute a risk of electric shock to persons.</p>
	<p>Power On Indicates the principal On/Off switch is in the On position.</p>
	<p>Power Off Indicates the principal On/Off switch is in the Off position.</p>
	<p>Protective Grounding Terminal Indicates a terminal that must be connected to earth ground before any other connections to the equipment may be made.</p>

1.0 Introduction

The Emerson Network Power® MPH2™ is the most intelligent, high-availability line of managed rack PDUs. It offers remote monitoring and control capabilities as well as environmental sensors with multiple power input selections and output configurations.

Metering Levels

Four types of MPH2 are available that offer metering of all electrical information including input, branch and receptacle levels, as well as integration with environmental sensors. The available information varies by type of MPH2. See **1.2 - Model Types**, page 7 for descriptions.

Mounting

Rack PDUs are available for mounting in vertical and horizontal configurations in standard racks or network enclosures.

Because the power cord is connected at the end of the vertical-mount (0-U) MPH2 models, the rack PDUs may be oriented to accommodate top or bottom cable-entry into the rack.

Locking Receptacles - IEC Type Only

Locking receptacles are available on models with IEC receptacles. The locking feature requires optional locking power cords to be installed on devices powered by the MPH2.

The receptacles require no modification to function properly with non-locking power cords.

Overcurrent Protection

All MPH2 Rack PDU units with input current rating of 30 A and higher feature 100% rated hydraulic-magnetic breakers. For all UL-listed models, the maximum cord and plug-connected loading is limited to 80% continuous loading, as required by UL in accordance with the National Electric Code.

Low-profile circuit breakers are used on all MPH2 0-U Rack PDUs with two or three branch circuits. Standard-profile circuit breakers are used on MPH2 horizontal models and on certain vertical models that have 6 branch circuits or have a 240 VAC rating. Each type of circuit breaker is a flush-mount, rocker style (see **Figure 3-17**).

Integrated Monitoring and Management

The factory-installed Emerson RPC2™ communications module permits managing the MPH2 Rack PDU over a secure Web page and SNMP-based network management system. The RPC2 permits interconnecting up to 4 rack PDUs in a Rack-PDU array configuration for monitoring and management.



NOTE

Do not interconnect RPC-1000 with RPC2 Rack PDUs in an array. They are incompatible and will not interoperate.



NOTE

Refer to the RPC2 communications module user manual, SL-20841, for detailed instructions on installing and using the RPC2 module. The document is available at Emerson's Web site: <http://www.emersonnetworkpower.com>

A rack PDU can be monitored locally through its on-board LCD, through a Web interface or through an optional display module, either the RPC BDM (Part# RPCBDM-1000). The display module connects directly to the RPC2 communications module and may be moved between operating MPH2 units. It can be hand-held, mounted in or on the rack or mounted on a wall near the rack PDU it is monitoring.

Multiple MPH2 Rack PDUs can be managed with these software applications:

- Avocent® Rack Power Manager software
- Avocent DSView™ management software
- Emerson’s Trellis™ Real-Time Infrastructure Optimization platform software
- Liebert® Nform®, which adds group-based receptacle management
- Liebert SiteScan®

Figure 1-1 Vertical MPH2 Rack PDU Configuration

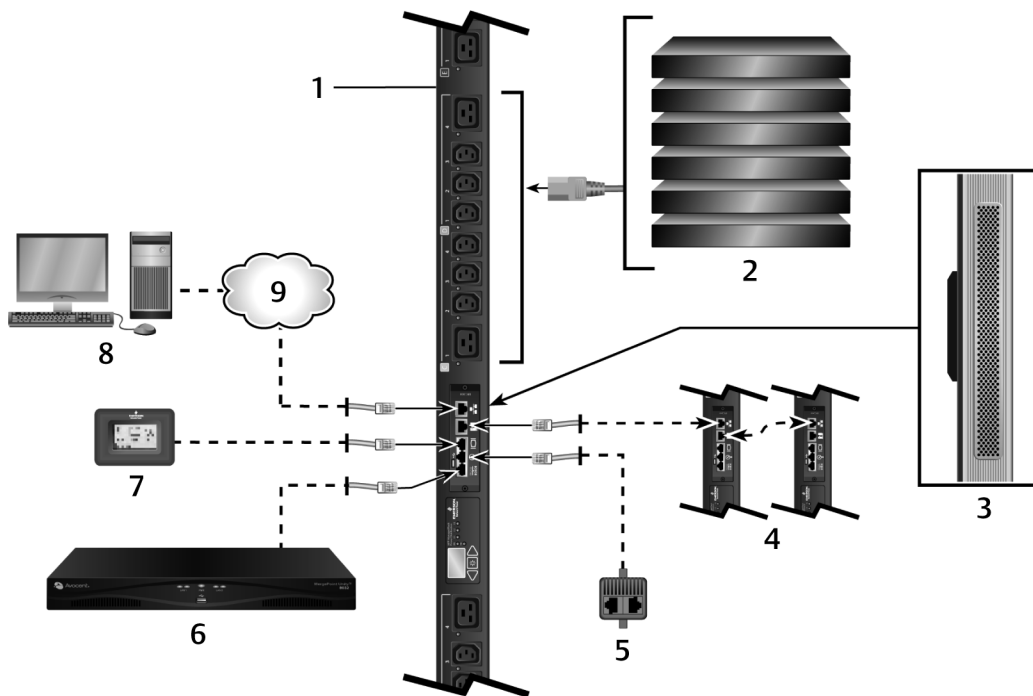

Number	Description	Number	Description
1	Vertical MPH2 Rack PDU	6	Serial appliance
2	Connected equipment	7	RPC basic display module (BDM)
3	Case ventilation, both sides (Optional)	8	Monitoring station
4	Rack PDU array	9	Network connection (10 MB/100 MB/1 GB)
5	Sensors—integrated and modular		

Figure 1-2 Horizontal MPH2 Rack PDU Configuration

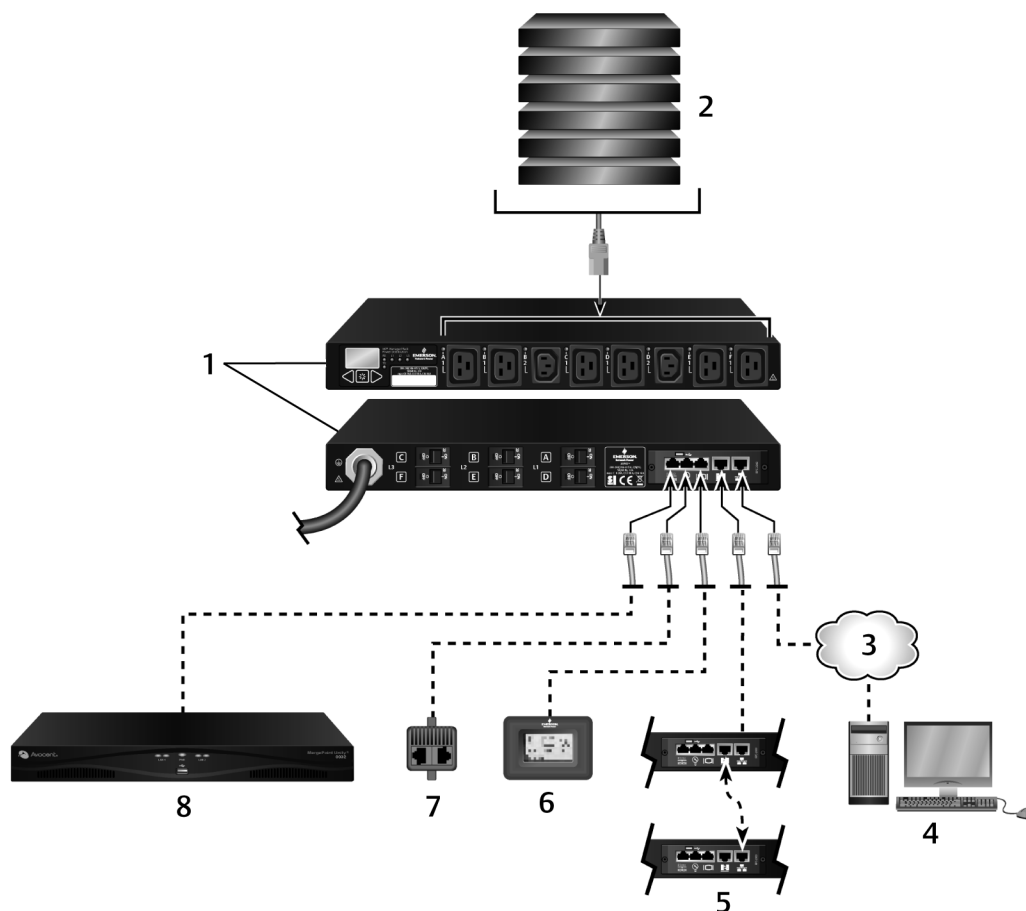

Number	Description	Number	Description
1	Horizontal MPH2 Rack PDU	5	Rack PDU array
2	Connected equipment	6	RPC basic display module (BDM)
3	Network connection (10 MB/100 MB/1 GB)	7	Sensors—integrated and modular
4	Monitoring station	8	Serial appliance

1.1 General Characteristics

- Input ampacities include 16 A or 32 A for European Union versions and 12 A to 48 A for North-American versions.
- Single-phase and three-phase.
- Input voltages include 100-120 VAC, 120/208 VAC, 200-240/415 VAC.
- Receptacle types include NEMA 5-20, IEC 60320 C13 and IEC 60320 C19
- Input connection supports a highly flexible fixed power cord or hard-wired connection to user accessible terminal block.

1.2 Model Types

There are four types of MPH2 Rack PDU. All models provide power distribution and include input and branch metering.

- **Type B**—Rack PDU metered: Provides metering of input and branches.
- **Type C**—Rack PDU metered, receptacle-switched: Provides metering of input and branches and individual on/off control of each receptacle.
- **Type M**—Receptacle-metered: Provides metering of input, branches and receptacles.
- **Type R**—Receptacle-metered, receptacle-switched: Provides metering of input, branches and receptacles. Provides individual on/off control of each receptacle.

1.3 Appearance and Components

1.3.1 Controls and Indicators—RPC2™

The MPH2 Rack PDU is monitored and managed by the factory-installed RPC2 communications module. This manual presents information about the MPH2's functions and features. For details on operating the MPH2 through the RPC2 communications module, refer to the RPC2 user manual, SL-20841. The document is available at Emerson's Web site: <http://www.emersonnetworkpower.com>

The RPC2 is installed near the middle of the MPH2 Rack PDU. The central location eases connections whichever orientation is required for network cabling.

The RPC2's Web-based interface provides system-operating measurements, sensor readings (optional) and basic unit information including firmware version, unit rating, model number and serial number.

Figure 1-3 MPH2 major monitoring and management features

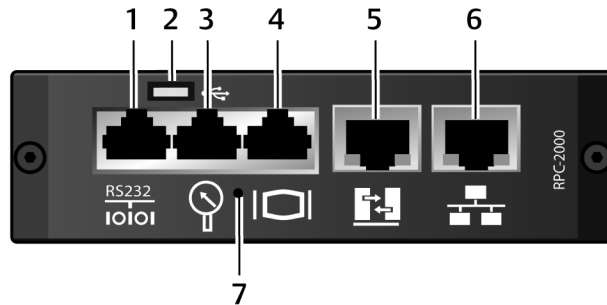

Number	Description	Number	Description
1	Serial port	5	Array link/management port
2	USB port	6	Network port
3	Sensor port	7	Access to Reset button
4	Display port		

1.3.2 LED Indicators

The MPH2 Rack PDU also has LEDs that indicate receptacle and branch status and system information. The LEDs flash, pulse or change colors to indicate an event or alarm condition (for details on how LEDs respond to events and alarms, refer to **5.0 - Troubleshooting**).



NOTE

Units with a “B” as the fourth character in the model name (MPHBxxxx) do not have LEDs at their receptacles. The branch and receptacle LED behavior in **5.0 - Troubleshooting** and elsewhere in this document does not apply to these units.

Receptacles on units with an “M” as the fourth character in the model name (MPHMxxxx) cannot be turned off. Refer to the description of branch and receptacle LED behavior in **5.0 - Troubleshooting**.

1.3.3 On-board LCD Controls and Indicators

Emerson’s MPH2 has an integrated, on-board LCD that can be used to view information about the rack PDU. The information available depends on the type of MPH2. For additional information about the on-board LCD, refer to **3.0 - Operation**.

1.3.4 Power Components

The component location and type depend on the model of the MPH2 Rack PDU. For example, units with a “B” as the fourth character in the model name do not have LEDs at their receptacles; see **Figures 1-4, 1-5 and 1-6**.

Figure 1-4 Branch and receptacle identification—Units with no monitoring (Type B models)

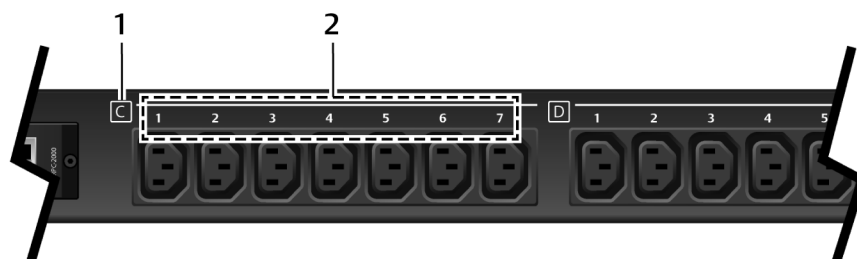

Number	Description
1	Branch identification
2	Receptacle identification

Figure 1-5 Branch and receptacle identification—Units with individually-monitored and managed receptacles (Type C, R and M models)

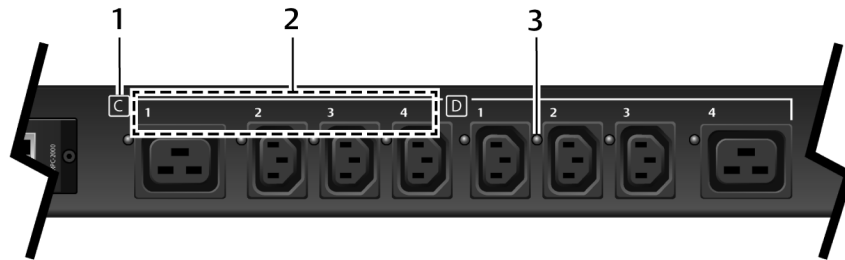

Number	Description
1	Branch identification
2	Receptacle identification
3	Receptacle-status LED (See 5.0 - Troubleshooting, page 42.)

1.3.4.1 Branch Overcurrent Protection

Models having more than 16-A input-current rating are equipped with branch overcurrent protection. The branch circuit breaker is a UL 489-listed breaker with a flush-mount, rocker-style actuator. This protects each receptacle group against overload and short circuit by interrupting the fault current flowing in the line-to-line, line-to-neutral and line-to-PE conductors of the branch circuits. The branch circuit breaker ratings apply over the full, rated operating temperature and frequency.

The flush-mount breakers guard against accidental trips that could interrupt power to the connected load. Manually tripping a breaker requires a small, flat blade, such as a screw driver (see **Figure 3-17**).

Low-profile circuit breakers are used on all MPH2 Rack PDUs with two or three branch circuits less than 240-V rating in a line-neutral configuration. Standard-profile circuit breakers are used on MPH2 Rack PDUs with six branch circuits or have a 240-VAC rating. Each type of circuit breaker is a rocker style (see **Figure 1-6**).

The branch circuit breaker labeling (A, B, C and so on) shows which receptacles are protected by each specific breaker. Receptacles on Branch A are protected by the circuit breaker labeled A. Three-phase PDUs may also have labeling showing the phase associated with each circuit breaker.



NOTE

The branch circuit breaker is not designed to be used as a disconnect device for the connected load.

Figure 1-6 Circuit breaker branch identification

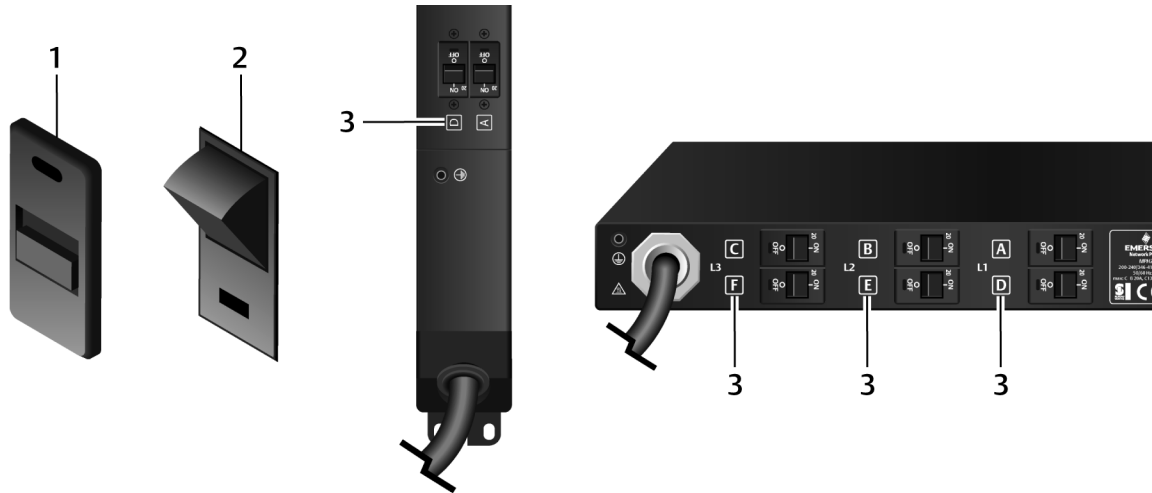

Number	Description
1	Low-profile circuit breaker
2	Standard-profile circuit breaker
3	Branch identification

1.3.5 Hard-Wired Connection Features

Emerson's MPH2 Rack PDU may be equipped with either a factory-installed input power cord or hard-wired connections. The hard-wired connection will be at one end of the unit. A terminal block in the hard-wired connection compartment is coded to aid in making the connections. A collar secures the input wire, keeping the strain off the terminal block connections. See **Figure 2-1**.

2.0 Installation

An MPH2 Rack PDU can be installed in an Emerson rack on the frame members using factory-supplied hardware. The unit can be installed on the face or the side of frame members. The unit can be mounted so that the power cord exits either the top or bottom of the rack.



NOTE

Follow all local and national electrical codes, standards and recommended practices.

Disconnect Required for Hard-Wired MPH2 Units

A readily-accessible input-power disconnect device must be installed near the MPH2 Rack PDU.

Input Power Location for MPH2 Units with Factory-Installed Power Cords

The input-power socket or outlet must be installed near the MPH2 and must be easily accessible.

2.1 Attaching Input Power Cords—Hard-wired Models Only

MPH2s with integral power cords need no assembly before installation. Units with hard-wired input power require attachment of input-power cords. See **Table 2-1** for wire sizing.

Hard-wired models may be wired with or without conduit.

2.1.1 Attaching Input-power Cords without Conduit

1. Remove the end cap. It is held in place with two T10 Torx screws.
2. Slide the terminal block cover off.
3. Loosen the strain-relief collar. It is held in place with two Phillips head PH1 screws.
4. Strip the insulation from the individual wires as required to fit into the terminal block.
Recommended stripping length for MPH2 units rated less than 32 A is 9 mm; for MPH2s rated 40 A or higher, 11 mm.
5. Slip the power cord through the hole in the end cap and through the strain-relief collar.
6. Loosen the terminal block screws.
7. Insert the wires into the terminal block according to the labeling inside the MPH2; tighten each terminal block screw after inserting a wire. Refer to **Table 2-2** for tightening torque.
8. Tighten the strain-relief collar around the input power cord. The cord's outer insulation covering should extend through the bracket.

9. Replace the terminal block cover by either sliding it on or snapping it into place.
10. Reattach the end cap to the MPH2 with the two screws removed in **Step 1**.

Figure 2-1 Disassembly to install an input-power cable

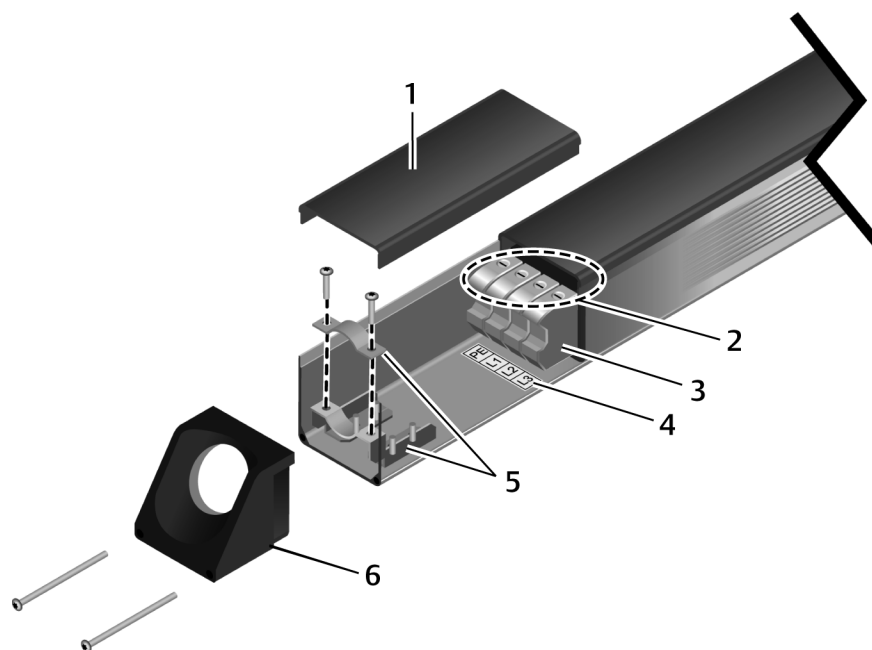

Number	Description	Number	Description
1	Cover plate	4	Terminal-block labels
2	Terminal-block screws	5	Strain-relief collar w/Phillips-head screws
3	Terminal blocks	6	End cap (attached with 2 screws)

2.1.2 Attaching Input-power Cords with Conduit

1. Remove the end cap. It is held in place with two T10 Torx screws.
2. Slide the terminal block cover off.
3. Loosen the strain-relief collar. It is held in place with four nuts (see **Figure 2-1**).
4. Strip the insulation from the individual wires as required to fit into the terminal block.
Recommended stripping length for MPH2 units rated less than 32 A is 9 mm; for MPH2s rated 40 A or higher, 11 mm.
5. Slip the stripped wires through the conduit connector, through the metal end plate and into the terminal block connection box.
6. Loosen the terminal block screws.
7. Insert the wires into the terminal block according to the labeling inside the MPH2; tighten each terminal block screw after inserting a wire. Refer to **Table 2-2** for tightening torque.
8. Install the cover plate, by either sliding it on or snapping it into place and sliding it firmly against the main body of the MPH2.
9. Install the cover plate, by either sliding it on or snapping it into place and pressing it against the cover plate.
10. Attach the metal end plate to the MPH2 with four screws provided in the kit.

11. Slide the conduit into the conduit connector.
12. Tighten the conduit connector until it grips the conduit and crimps it securely.

Figure 2-2 Re-assembly to install an input power cable in conduit

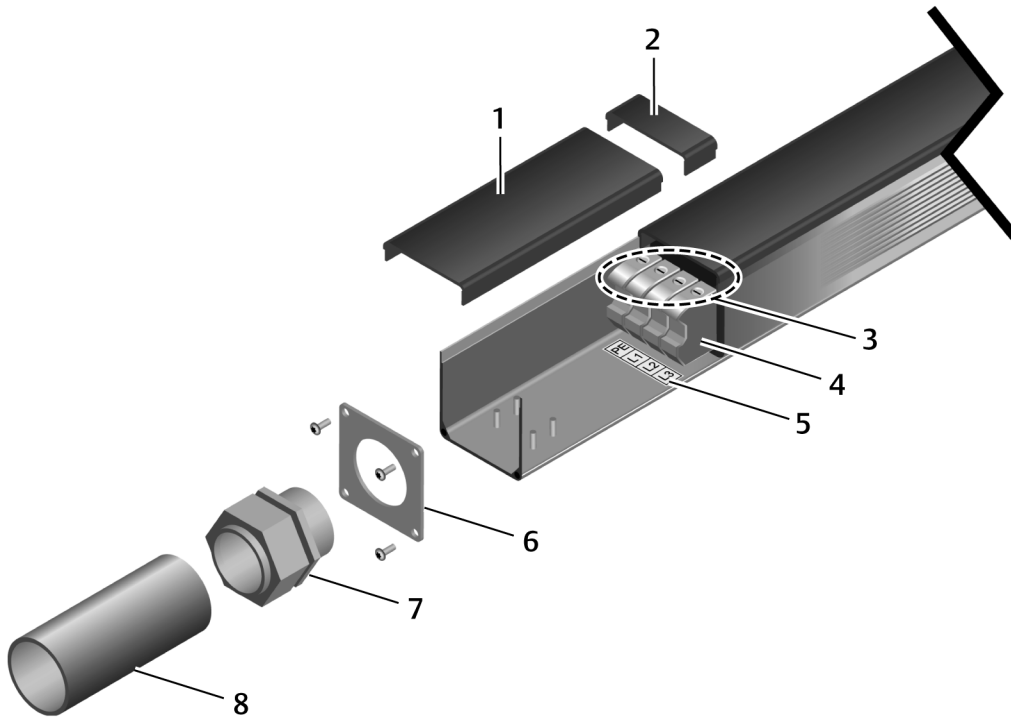

Number	Description	Number	Description
1	Cover plate	5	Strain-relief collar w/Phillips-head screws
2	Terminal-block screws	6	Metal end plate (attached with 4 screws)
3	Terminal blocks	7	Conduit connector (field-supplied)
4	Terminal-block labels	8	Conduit (cable not shown)

Table 2-1 Hard-wired models—Connection terminal ratings

	MPH2 Rating	
	≤32 A	>32 A
Conductor Cross-Section Solid, Minimum	0.2 mm ²	0.5 mm ²
Conductor Cross-Section Solid, Maximum	6 mm ²	16 mm ²
Conductor Cross-Section Stranded, Minimum	0.2 mm ²	0.5mm ²
Conductor Cross-Section Stranded, Maximum	4 mm ²	10 mm ²
Conductor Cross-Section, AWG/kcmil, Minimum	24	20
Conductor Cross-Section, AWG/kcmil, Maximum	10	6
Conductor Cross-Section Stranded, with Ferrule without Plastic Sleeve, Minimum	0.25 mm ²	0.5 mm ²
Conductor Cross-Section Stranded, with Ferrule without Plastic Sleeve, Maximum	4 mm ²	10 mm ²
Conductor Cross-Section Stranded, with Ferrule with Plastic Sleeve, Minimum	0.25 mm ²	0.5 mm ²
Conductor Cross-Section Stranded, with Ferrule with Plastic Sleeve, Maximum	4 mm ²	10 mm ²

Table 2-2 Terminal tightening torque

Tightening Torque	MPH2 Rating	
	≤32 A	>32 A
Minimum	0.6 Nm (4.4 lb-in.)	1.5 Nm (13.3 lb-in.)
Maximum	0.8 Nm (7.1 lb-in.)	1.8 Nm (15.9 lb-in.)

2.2 Tool-less Mounting

For tool-less mounting, attach the mounts to the rear of the MPH2 Rack PDU, then hang it in the rack as shown in **Figure 2-3**. Torque the screw attaching the mounting button 17 lb-in. (2 Nm).



NOTE

Brackets are not supplied. A range of brackets for Emerson and other manufacturers' racks are available as accessories.

Figure 2-3 Tool-less mounting

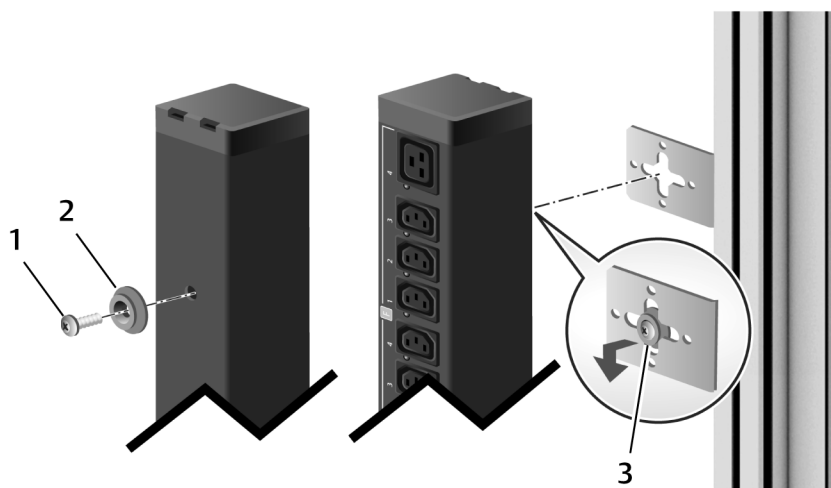

Number	Description
1	Torx screw (tighten torque 17 lb-in. (2 Nm))
2	Button mount
3	Insert button mount into keyhole slot.

2.3 Installing a MPH2 in an Emerson® Rack

2.3.1 Mounting Hardware and Tools Required

Factory-supplied

- 2 mounting brackets
- 2 mounting buttons
- 4 spring nuts

Field-supplied

For mounting a vertical MPH2

- Phillips #2 screwdriver

For mounting a horizontal MPH2:

- Flat-blade screwdriver
- Torx screwdriver TX30
- Torque wrench

2.3.2 Mounting the Vertical MPH2

The vertical MPH2 can be installed on a vertical or horizontal frame member in the rack.

1. Determine where in the Emerson rack the PDU will be installed.
2. Attach a bracket to each end of the PDU.
3. If mounting on horizontal frame members, attach the brackets in-line, **Figure 2-4**.

- or -

If mounting on a vertical frame member, attach the brackets at a right angle to the PDU.

4. Insert two spring nuts into the appropriate T-slot on the frame member, **Figure 2-4**. Position the spring nuts to accommodate screws inserted through slots in the brackets. To move the spring nuts, press down on each with a small, pointed object and slide each into position.
5. Hold the PDU in place and attach the top of the unit to the rack with tool-less fasteners, **Figure 2-4**.

6. Tighten the screws, applying 46 lb-in (5.2 Nm).
7. Repeat **Steps 4** through **6** for the lower bracket on the lower end of the PDU.

Figure 2-4 Installing vertical MPH2 in an Emerson rack

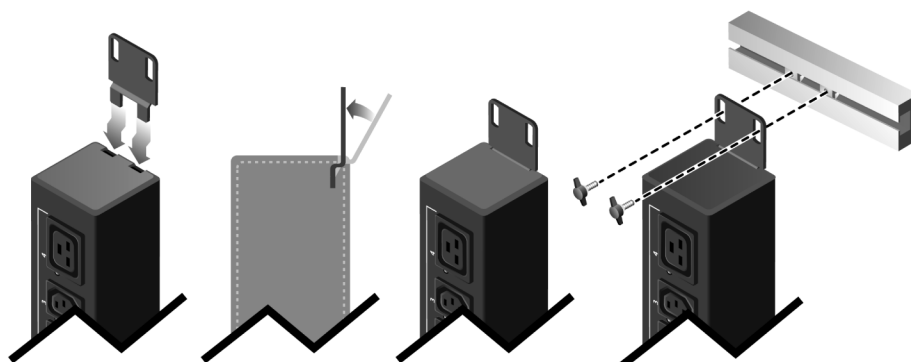

2.3.3 Mounting the Horizontal MPH2

The horizontal MPH2 is installed on a vertical frame member in the rack.

1. Choose a position in the rack for the PDU and install 4 cage nuts into the respective slots, **Figure 2-5**.
2. Hold the MPH2 PDU over the desired mounting holes (now with the cage nuts), and route the input cable through the rack as desired.
3. Insert screws and use a Torx T30 screwdriver to tighten all of them. Leave the screws slightly loose for the time being, **Figure 2-5**.
4. Once all the screws are installed, tighten them completely using 35.4 lb-in (5.2 Nm).

Figure 2-5 Installing horizontal MPH2 in an Emerson rack

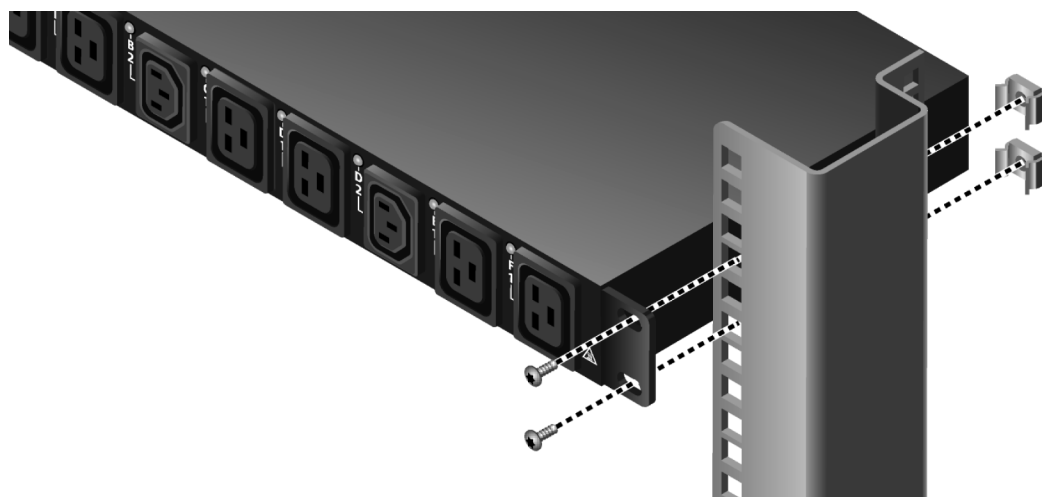

2.3.4 Mounting Horizontal MPH2 on Vertical Frame Member with Aluminum Extrusions

1. Choose a position in the rack for the PDU and install 4 spring nuts into the groove, **Figure 2-6**.
2. Use a level to check if the horizontal plane is maintained.
3. Set the distance to match the holes on the PDU, and hold the MPH2 PDU over the desired position (now with the spring nuts).
4. Route the input cable through the rack as desired.
5. Insert screws and use a Torx T30 screwdriver to tighten all of them, **Figure 2-6**. Leave the screws slightly loose for the time being.
6. Once all the screws are installed, tighten them completely using 35.4 lb-in (5.2 Nm).

Figure 2-6 Installing horizontal MPH2 in a rack with aluminum extrusions

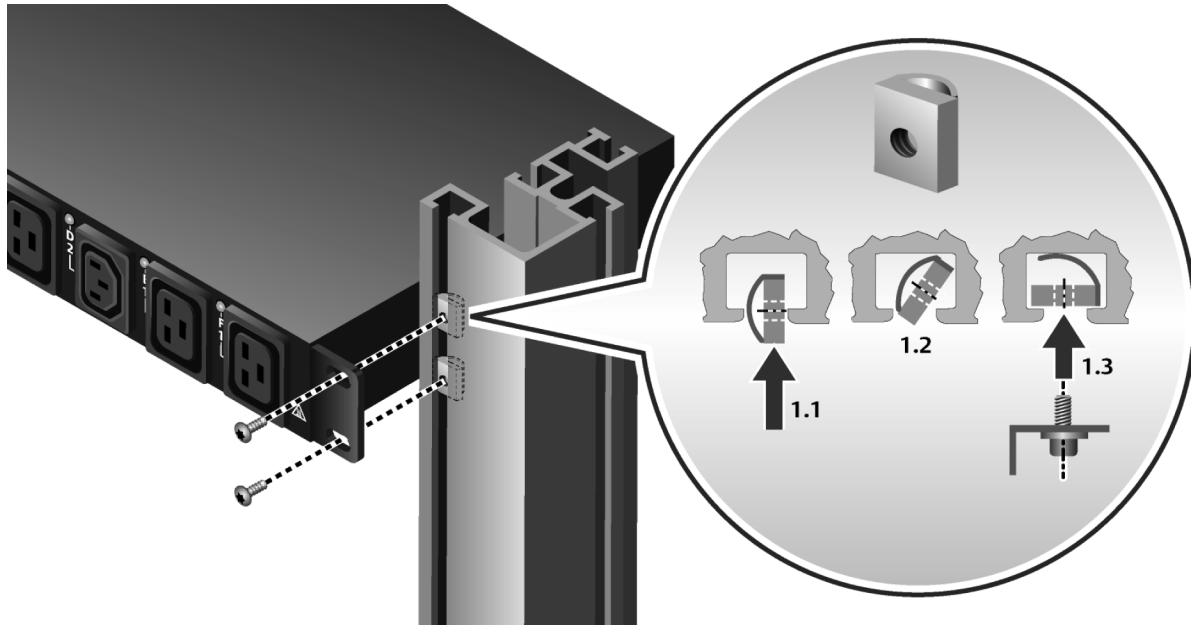

2.3.5 Rack Grounding strap



NOTE

Ensure that the safety-earth connection at the input-power-source receptacle is made before any equipment is connected to Emerson's MPH2 Rack PDU.

Units with factory-attached input-power cords have an grounding conductor internal to the case. The rack grounding strap establishes the same ground reference between the MPH2 Rack PDU and the rack.



NOTE

The grounding strap may be used with MPH2 Rack PDUs that have integral input-power cords and units that have hard-wired input-power cords. The strap supplements the internal grounding conductor of the integral power-supply cord.

The grounding strap may be particularly useful when the rack is on a raised floor.

Table 2-3 Ground-strap wire gauge by MPH2 rating

Rating	Wire Size		
	NA, UL Listed	EU, CE Marked	WW
12 A	14 AWG	—	—
16 A	12 AWG	4.0 mm ²	12 AWG or 4.0 mm ²
24 A	10 AWG	—	—
32 A	—	6.0 mm ²	—
40 A	6 AWG	—	—
48 A	6 AWG	—	—

1. Insert a spring nut into the rack frame near the grounding point on the MPH2 (see **Figure 2-3** for inserting the spring nut).
2. Attach a ground wire to the rack with a screw, washer and lock washer. The screw is secured to the rack's frame with a spring nut.
3. Use a second field-supplied screw, washer and lock washer to secure the ground wire to the MPH2. The connection point is marked with an earth-ground symbol  (see **Figure 2-7**).

Figure 2-7 Rack grounding-strap connection



Number	Description	Number	Description
1	Ground-wire connection screw, M6 x 12	4	Lock washer
2	Washer	5	Ground-wire connection on MPH2 (location may vary)
3	Ground-wire connector (to MPH2)	6	Ground-wire connector (to rack)

2.3.6 Recommended Electrical-backup Protection

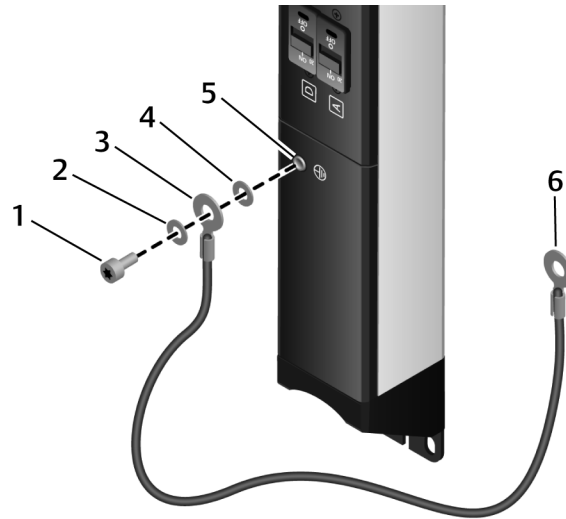
A field-provided external circuit breaker must be installed upstream of the MPH2 Rack PDU. The circuit breaker must be sized according to the input rating of the PDU. The circuit breaker rating must meet the values in **Table 2-4**.

The external circuit breaker serves as the primary input power disconnect for the MPH2.

Table 2-4 Upstream circuit breaker rating

Maximum Input Current Per Pole	Rated Current of Upstream CB
12 A	15 A (NA)
16 A	20 A (NA) 16 A (EU, WW)
24 A	30 A (NA)
32 A	32 A (EU, WW)
40 A	50 A (NA)
48 A	60 A (NA)
63 A	63 A (EU, WW)

2.4 Connecting Rack Equipment



NOTE

Circuit breakers on Emerson's MPH2 Rack PDU are opened at the factory. The open circuit breakers help protect against high inrush current when input power is first connected.

To mitigate in-rush currents:

- *Close the branch circuit breakers after all receptacle loads are connected.*
- or –
- *For MPH2-C and MPH2-R models, turn the receptacle off before connecting the load.*

Once the MPH2 Rack PDU has been installed in the rack, the unit is ready for connection of equipment that will be powered by the unit or used for monitoring.

Verify that the equipment to be connected meet these requirements:

- Input power requirements of each load do not exceed the MPH2 receptacle ratings.
- Input power cords meet or exceed the rating of the MPH2 receptacles and are fully-engaged.
- Total equipment power consumption will not overload the MPH2 Rack PDU.

To connect devices to an MPH2 Rack PDU:

1. Make sure that input power is installed in accordance with national and local electric codes.
2. Verify that all devices to be connected are shut down and unplugged from input power sources.
3. If the MPH2 Rack PDU will be monitored over a network, connect an Ethernet cable to the LAN port on the RPC2.
4. Route the devices' power cables to the MPH2 Rack PDU, following proper procedures and good practices, such as segregating power cables from control cables and keeping cable bends to recommended angles.
5. Verify that the branch circuit breakers on the MPH2 Rack PDU are open.

6. Connect the devices' input power cables to the MPH2 Rack PDU.



NOTE

All C13 and C19 receptacles on MPH2 Rack PDUs are locking receptacles. Locking requires use of special power cords, which may be factory-installed on the equipment or is available from Emerson.

If non-locking power cords are used, the power cords should be secured through other methods to prevent unintended power interruption.

7. Record where each piece of rack equipment is connected, using the branch and receptacle numbers on the MPH2 Rack PDU.
8. Post the connection information on or near the rack and at any remote monitoring location.
9. Connect input power to the MPH2 Rack PDU. On Types R, C and M models, the receptacle LEDs pulse RED indicating that the branch circuit breakers are open.
10. Verify that input power is present and the line-status LEDs are illuminated green and steady state. If any LEDs are not lit or are blinking, refer to **Table 5-2 - Line LED Troubleshooting**, page 39.
11. Close the branch circuit breakers. The receptacle LEDs are lit green and steady-state. If any LEDs are not lit or are blinking, refer to **Table 5-1 - Receptacle LED Troubleshooting**, page 38.
12. Turn on the connected devices one at a time and verify that each is operating properly.
13. Ensure that the specified ratings found on the MPH2 Rack PDUs name plate are not exceeded.
14. Monitor and control the MPH2 Rack PDU as detailed in the RPC2 user manual, SL-20841, available at www.emersonnetworkpower.com

2.5 Installing Optional Items

The following items may be added to an MPH2 Rack PDU system but are not required.

- RPC Basic Display Module
- Liebert® SN temperature/humidity sensors

2.5.1 RPC Basic Display Module Installation

The RPC Basic Display Module (BDM) provides local display of parametric data, including electrical status, temperature and humidity for all connected MPH2 Rack PDUs. Display information is accessed via a navigation switch on the BDM. The RPC BDM is connected by cable to the MPH2 Rack PDU, allowing the user to install the display to suit the local reading requirements. A 6.5-ft. (2-m) cable and general mounting provisions are provided. A single display can be used for up to four rack PDUs connected in a Rack PDU Array™.

The RPC BDM can be mounted in the rack with either the included hardware or with a cable tie through the slot on the back of the module. Either method permits moving the BDM to a different place in the same rack or to another rack.

2.5.1.1 Included Hardware

- RPC BDM, 1
- Spring Nut M5, 1
- Spacer Sleeve, 1
- Mounting Button, 1
- M5 Screw, 1
- Cable Clip, 1

Figure 2-8 RPC BDM

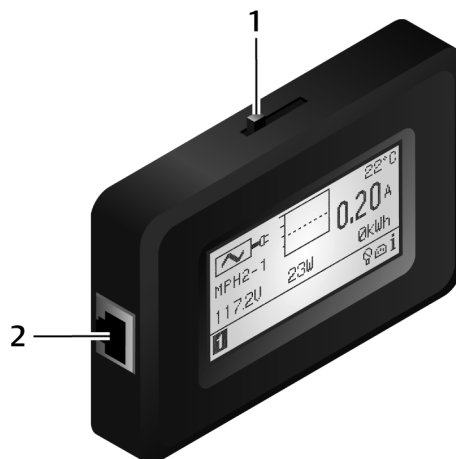

Number	Description
1	Scan switch
2	RJ-45 communication and power input port

To install an RPC BDM in a rack:

1. Determine the mounting location on the frame member where the RPC BDM will be installed.
2. Insert a spring nut into a T-slot and flip it so that it is square in the slot as shown in **Figure 2-9**.

Figure 2-9 Inserting the spring nut into a T-slot

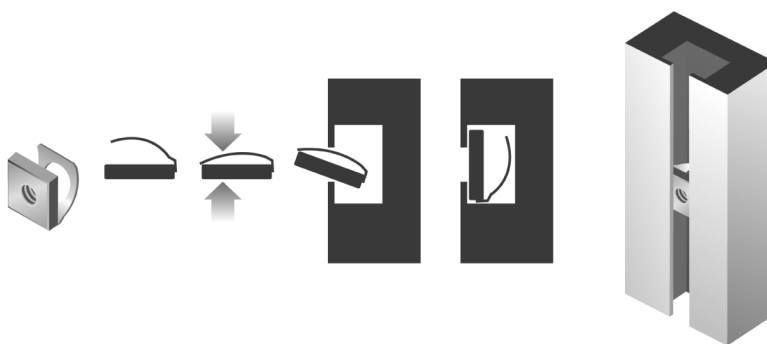

3. Insert the MPH2 Rack PDU screw into the spacer sleeve.
4. Insert the MPH2 Rack PDU screw into the spring nut and tighten securely with a flat-head screwdriver.
5. Hang the RPC BDM on the screw with the hooded mounting slot on the back of the RPC BDM.
6. Connect the RPC BDM to the RPC2 with an Ethernet cable.
7. Be certain to connect the cable to the correct port on the RPC2.

2.5.2 Temperature/Humidity Sensor Installation

Optional Liebert® SN temperature/humidity sensors are available to assist in monitoring conditions in the rack. Liebert SN sensors are designed for installation in Emerson racks without tools, but each may be placed in any area to monitor temperature and humidity levels. Each connects to the RPC2 communications module, which makes readings available to other monitoring methods.

To install a sensor in a rack:

1. Insert the sensor bracket base into one end of the sensor support.
2. Snap the sensor into the other end of the sensor support.
3. Choose where in the rack to install the sensor assembly.



NOTE

Emerson recommends placing the sensor in the area of the rack that is likely to be warmest. That location helps determine extreme conditions that can cause equipment damage.

4. Hold the sensor bracket on a T-slot on the Emerson rack frame where the sensor will be placed.
5. Insert the included quarter-turn fastener through the rectangular hole in the sensor bracket base and into the T-slot.
6. Turn the fastener clockwise 90 degrees, a quarter of a turn.
7. Route the sensor cable to the RPC2 communications module and insert it into the card's external sensor port.



NOTE

For more information, see the RPC2 user manual, SL-20841, available at Emerson's Web site, <http://www.emersonnetworkpower.com>

3.0 Operation

Emerson’s MPH2 Rack PDU may be monitored and managed by the factory-installed RPC2 communications module. This manual presents information about the MPH2’s functions and features. Refer to the RPC2 user manual, SL-20841, for details on using the RPC2 communications module to monitor and manage the MPH2. The document shipped with the MPH2 Rack PDU and is available at Emerson’s Web site, <http://www.emersonnetworkpower.com>

The MPH2’s on-board LCD and the Web-based interface display system operating measurements, as well as readings from optional Liebert SN temperature or temperature/humidity sensors. The RPC2 communications module and on-board LCD also display basic information about the MPH2 Rack PDU, such as firmware version, unit rating, model number and serial number.

LEDs on the MPH2 and an audible alarm also assist in monitoring performance with alerts about events and alarm conditions. The keys under the on-board LCD are used to navigate to various information and to silence alarms.

3.1 Controls and Indicators

The MPH2 Rack PDU also has LEDs that indicate receptacle and branch status and system information. LEDs flash, pulse or change colors to indicate an event or alarm condition (for details on how LEDs respond to events and alarms, refer to **5.0 - Troubleshooting**).



NOTE

*Units with a “B” as the fourth character in the model name (MPHBxxxx) do not have LEDs at their receptacles. The branch and receptacle LED behavior in **5.0 - Troubleshooting** and elsewhere in this document does not apply to these units.*

Receptacles on units with an “M” as the fourth character in the model name (MPHMxxxx) cannot be turned Off. LEDs at receptacles on these models are always either on continuously or flashing when input power is present.

Figure 3-1 On-board LCD and control keys

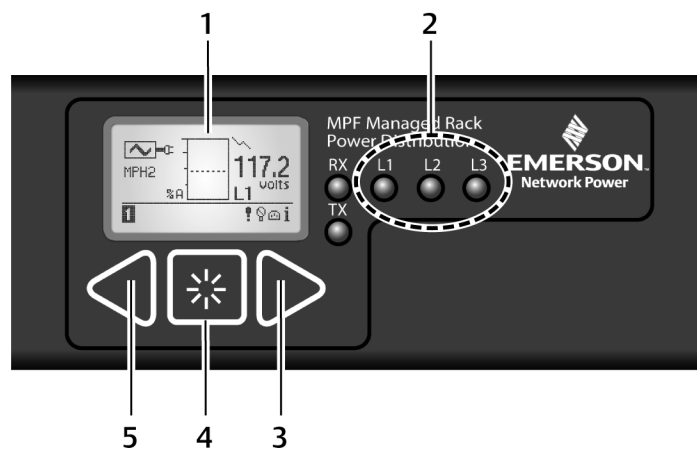

Number	Description
1	On-board LCD
2	Line-input-status LEDs
3	Right-arrow key
4	Select key
5	Left-arrow key

3.2 View Input-level Information

The MPH2's main screen is displayed by the on-board LCD when the rack PDU is first powered up. The input-level information is the main screen, **Figure 3-2**.



NOTE

After 5 minutes of no activity (no key pressed), the on-board LCD returns to the main screen.



NOTE

During a firmware upgrade:

- The Line-input status LEDs flash red and green, and the rack PDU continues receiving and distributing power without interruption.

Figure 3-2 Input-level information (main screen)

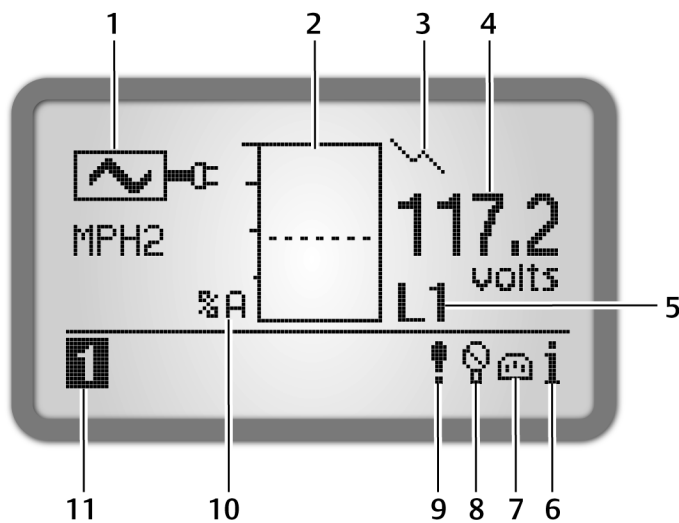

Number	Description	Number	Description
1	Input-level metered information icon	7	Receptacle icon
2	Bar graph of input current	8	Sensor icon
3	Link icon	9	Alarm icon
4	Input voltage	10	% Amperes used until alarm threshold.
5	Voltage phase	11	Unit identification (always shows unit 1)
6	Information icon		

3.2.1 Communication Link with RPC2

When power is cycled to the MPH2, it takes a few moments to establish communication and load the configuration information from RPC2, such as receptacle labels and IP and MAC addresses.

When configuration changes (such as turning-on/off a receptacle) require that the LCD screen update, the configuration wheel appears and spins, **Figure 3-3**, to indicate that navigation is unavailable while configuration is in-progress.

Figure 3-3 Configuration in-progress wheel

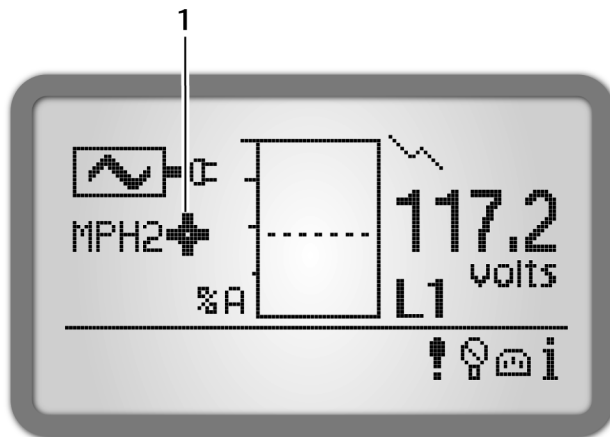

Number	Description
1	Configuration wheel

3.3 View MPH2 System Information



1. Use the arrow keys to highlight the information icon, .
2. Press .
The MPH2 model number, serial number, firmware version, power rating and number of receptacles display, **Figure 3-4**.

Figure 3-4 System information



NOTE

The firmware version and other information in the figure are an examples only.

3.3.1 System and Screen Options

On the system-information screen is a menu of icons that provides access to further system options, network information, and LCD-screen options, **Figure 3-5**.

Figure 3-5 System-info and Screen-option icons

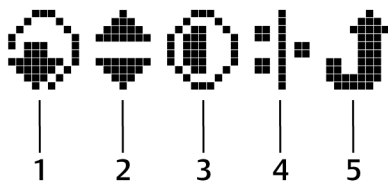

Number	Description
1	Reboot/Restore-defaults icon
2	Flip screen orientation icon
3	Adjust screen contrast icon
4	System network icon
5	Up-to-previous-level icon

3.3.2 Reboot the On-board LCD









1. Use the arrow keys to highlight the information icon, **i**, and press .
2. Use an arrow key to highlight the reboot/restore-defaults icon, , and press .
The Reboot Options display, **Figure 3-6**.

Figure 3-6 Reboot Options

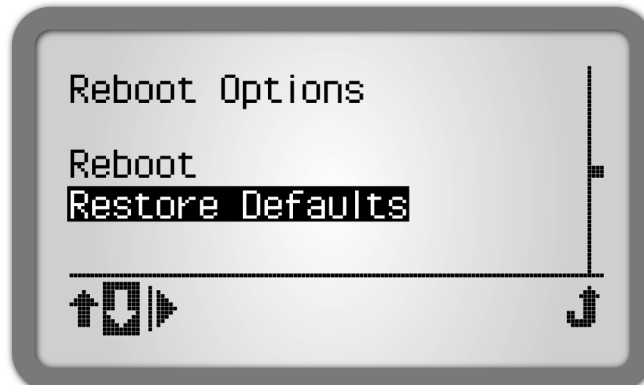

3. Use the arrow keys to highlight an up/down arrow at the bottom-left, and press  to highlight *Reboot*.
4. Use the arrow keys to highlight the play button, , and press .
The Reboot? confirmation displays.
5. Use the arrow keys to highlight an up/down arrow, and press  to highlight *Yes / Reboot Now*.
6. Press .
The system reboots.

3.3.3 Restore System Defaults

Table 3-1 describes the factory-default settings.



1. Use the arrow keys to highlight the information icon, **i**, and press .
2. Use an arrow key highlight the reboot/restore-defaults icon, , and press . The Reboot Options display, **Figure 3-6**.

Figure 3-7 Restore Defaults selected on Reboot Options





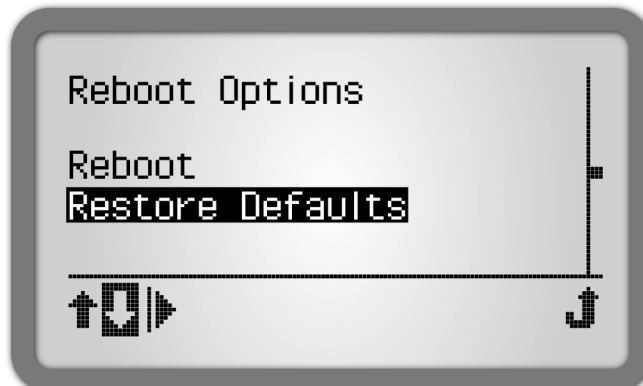

3. Use the arrow keys to highlight an up/down arrow at the bottom-left, and press  to highlight *Restore Defaults*.
4. Use the arrow keys to highlight the play button, , and press . The Restore Defaults? confirmation displays, **Figure 3-8**.
5. Use the arrow keys to highlight an up/down arrow, and press  to highlight *Yes/ Reboot to Default*.
6. Press . The system-default settings are restored.

Figure 3-8 Restore Defaults? confirmation



The default settings described in **Table 3-1** apply only to MPH2, are set at time of manufacture and are applied when “Restore to Factory Defaults” is initiated via RPC2 clients.

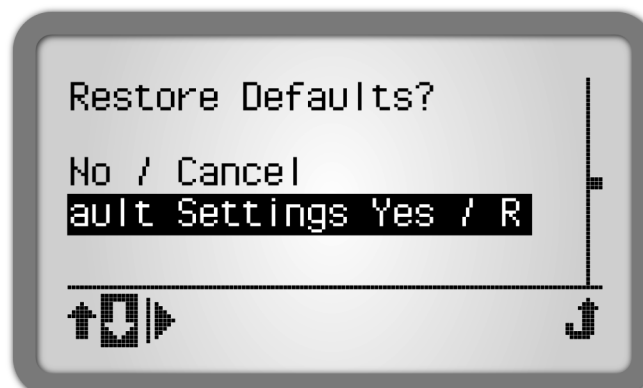

NOTE

For detailed information about settings and about network- and protocol-related default settings for RPC2, see SL-20841. The document is available at Emerson’s Web site: <http://www.emersonnetworkpower.com>

Table 3-1 Factory-default settings

Level	Settings	Default Value	Units	Models Affected	Notes
PDU	User Assigned Label	MPH2 or Rack PDU <alpha>	—	All	• RackPDU is default value the first time only.
	Asset Tag 1	<empty>	—	All	• Allowed characters include alphanumeric, space, and ~!#\$_%+`-={} []\;:’?.,\%^&*()@
	Asset Tag 2	<empty>	—	All	
	Overcurrent Alarm Threshold	45	%	All	• % calculated from maximum input-current rating on nameplate. • Default values are recommended for dual-corded server applications.
	Overcurrent Warning Threshold	40	%	All	
	Undercurrent Alarm Threshold	0	%	All	
	Unbalanced Load Alarm threshold	0	%	All 3-phase	% difference calculated between any two phases.
Software Over Current Protection (SWOCP)	Disabled	—	R	Conditionally applies to unlocked and unloaded receptacles only.	
Branch	User Assigned Label	Branch <alpha>	—	All	Allowed characters include alphanumeric, space, and ~!#\$_%+`-={} []\;:’?.,\%^&*()@
	Asset Tag 1	<empty>	—	All	
	Asset Tag 2	<empty>	—	All	
	Overcurrent Alarm Threshold	95	%	All	% calculated from CB rating. Refer to nameplate for maximum branch current rating.
	Overcurrent Warning Threshold	90	%	All	
	Undercurrent Alarm Threshold	0	%	All	
	SWOCP	Disabled	—	R	Conditionally applies to all unlocked and unloaded receptacles only for this branch.

Table 3-1 Factory-default settings (continued)

Level	Settings	Default Value	Units	Models Affected	Notes
Receptacle	User Assigned Label	Receptacle <number>	—	All	Allowed characters include alphanumeric, space, and ~!#\$_%&'()*@
	Asset Tag 1	<empty>	—	All	
	Asset Tag 2	<empty>	—	All	
	Overcurrent Alarm Threshold	95	%	M,R	Configurable per receptacle. % calculated from maximum receptacle current rating on nameplate.
	Overcurrent Warning Threshold	90	%	M,R	
	Undercurrent Alarm Threshold	0	%	M,R	
	Power Up State	Restore	—	C,R	Restore returns receptacle power state to last programmed state after expiration of Power On Delay.
	Power On Delay	0	seconds	C,R	The delay timing begins after measurement stability is achieved.
	Power Cycle Delay	8	seconds	C,R	A Power Cycle turns off power to the receptacle for the specified delay.
	Post On Delay	0	seconds	C,R	Delay before RPC2 issues command to power on receptacle.
	Post Off Delay	0	seconds	C,R	Delay before RPC2 issues command to power off receptacle.
	Software Over Temperature Protection (SWOTP)	Disabled	—	C,R	<ul style="list-style-type: none"> Unconditionally applies regardless of locked/unlocked and loaded/unloaded status. At least one temperature sensor is required.
	SWOTP Delay	10	seconds	C,R	Delay required for persistent over-temperature alarm condition before SWOTP triggered.
	SWOTP Scope	Local	—	C,R	<ul style="list-style-type: none"> Local = affects only PDU connected to the temperature sensor that triggered SWOTP. Array = affects all PDUs regardless of temperature sensor that triggered SWOTP.
	Criticality	Critical	—	C,R	Affects power control when a member of a receptacle group.
Locked/Unlocked	Unlocked	—	C,R	Affects authorization to manage power control and behavior of SWOCP.	

3.3.4 Determine IP Address, MAC Address and Firmware Version



1. Use the arrow keys to highlight the information icon, **i**, and press .
2. Use an arrow key to highlight the network icon, , and press .
The IP address, MAC address, firmware, date and time display, **Figure 3-9**.

Figure 3-9 IP address, MAC address, and firmware information



Number	Description
1	IP address
2	MAC address
3	Agent firmware type and version

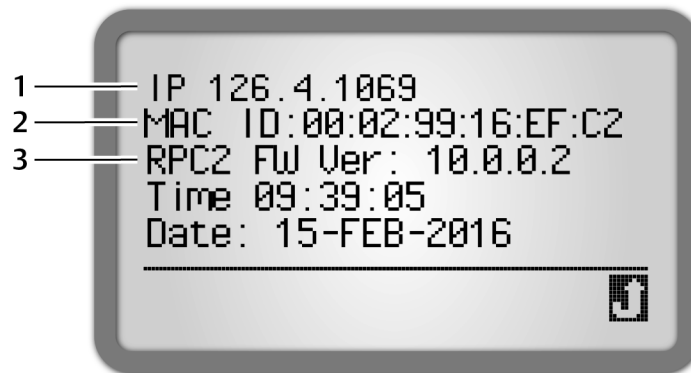

NOTE

The firmware version and other information in the figure are examples only.







3.3.5 Adjust the Contrast of the On-board LCD



NOTE

Contrast adjustment may help improve LCD-screen legibility in a high-temperature environment.

The on-board LCD is factory-set to be easily viewed in lighting conditions found in most work places. The contrast can be changed.

1. Press any key to activate the LCD.
2. Use the arrow keys to highlight the information icon, **i**, and press .
3. Use the arrow keys to highlight the contrast icon, , and press .
4. Use the arrow keys to highlight an up/down arrow, and press  to increase or decrease contrast. Refer to the pattern, **Figure 3-10**, to determine when the contrast is acceptable.
5. When the contrast is satisfactory, highlight  and press  to return to the system-information screen.



NOTE





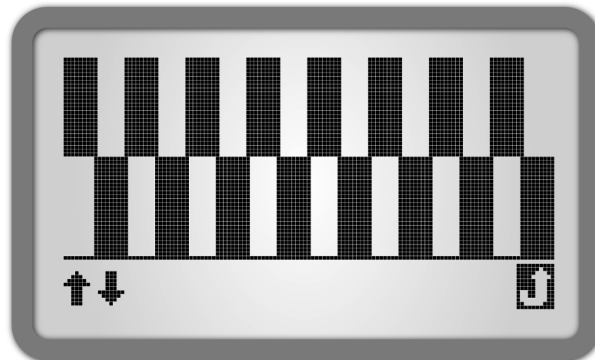

These steps also apply to the RPC BDM.

Figure 3-10 Adjust LCD contrast



3.3.6 Adjust the Orientation of the On-board LCD

Because mounting of the MPH2 in the rack may vary, the on-board LCD may be “flipped” to change the screen orientation for viewing ease.

1. Press any key to activate the LCD.
2. Use the arrow keys to highlight the information icon, , and press .
3. Use the arrow keys to highlight the flip-orientation icon, , and press . The screen “flips” orientation.
4. Highlight  and press  to return to the input-level screen.



NOTE

These steps also apply to the RPC BDM.

3.4 View Active Alarms



NOTE

The most-recent alarms are at the top of the list.





1. Use the arrow keys to highlight the alarm icon, , and press . A list of active alarms on the MPH2 displays, **Figure 3-11**.
2. Use the arrow keys to highlight an up/down arrow, and press  to highlight an alarm.
3. Highlight the play button, , and press . The alarm details display.

Figure 3-11 Alarm list



3.4.1 Silence an Audible Alarm

To silence an audible alarm, press any of the three navigation keys below the LCD.

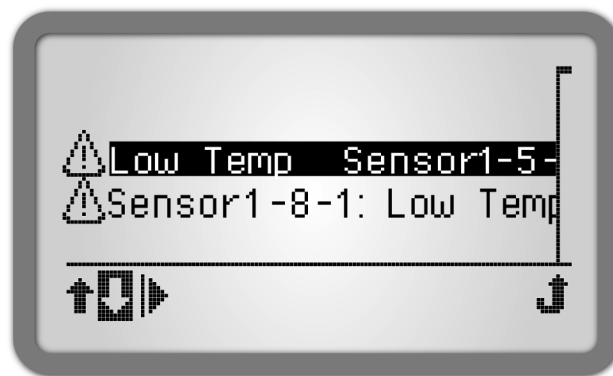
See **5.0 - Troubleshooting** for details about how the LED interface signifies events and alarms.

3.5 View Branch-level Information





1. At the input-level (main) screen, highlight the unit-identification number, **1**, and press . The branch letters display along the bottom-left, **Figure 3-12**.
2. Use the arrow keys to highlight the letter of the branch to view, and press . Information about the selected branch displays, **Figure 3-12**.
 - To display more details about the selected branch, highlight the information icon, **i**, and press .
 - To return to the previous level view, highlight  and press .

Figure 3-12 Branch information



Number	Description
1	Branch-level information icon
2	Branch circuit-breaker status icon I = closed circuit breaker O = open circuit breaker
3	Branches (two shown, A and B)

3.6 View Receptacle-level Information

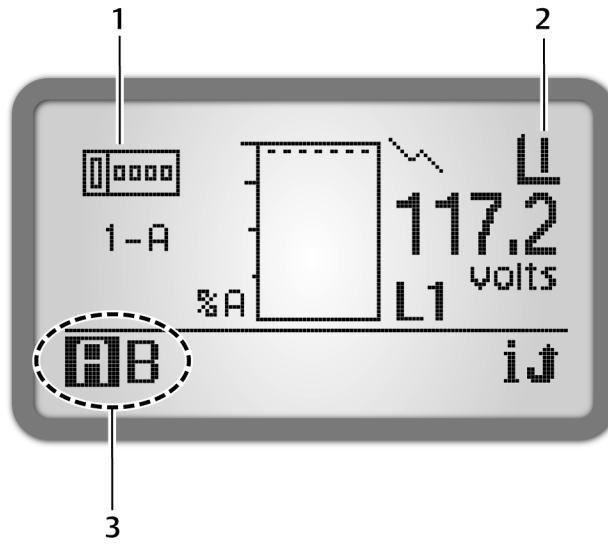

1. At the input-level (main) screen, highlight the receptacle icon, , and press . The receptacle list displays, **Figure 3-13**.

Figure 3-13 Receptacle list







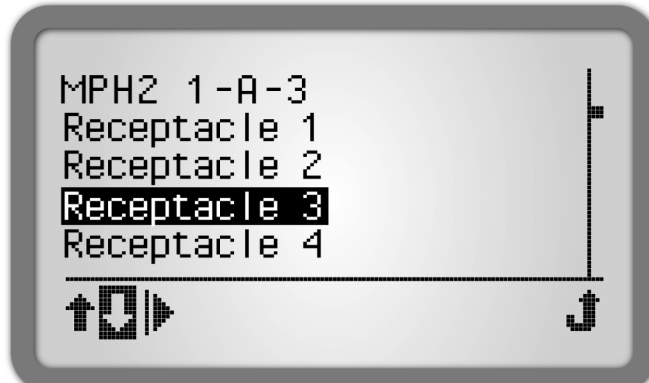





2. Use the arrow keys to highlight an up/down arrow at the bottom-left, and press  to highlight a receptacle.
3. Highlight the play button, , and press . The receptacle information displays, **Figure 3-14**. The receptacle numbers display along the bottom-left, and the number of the selected receptacle number flashes.
4. To view a different receptacle, highlight the number of the receptacle, and press .
 - To display more details about the selected receptacle, highlight the information icon, , and press .
 - To return to the previous level view, highlight  and press .

Figure 3-14 Receptacle information

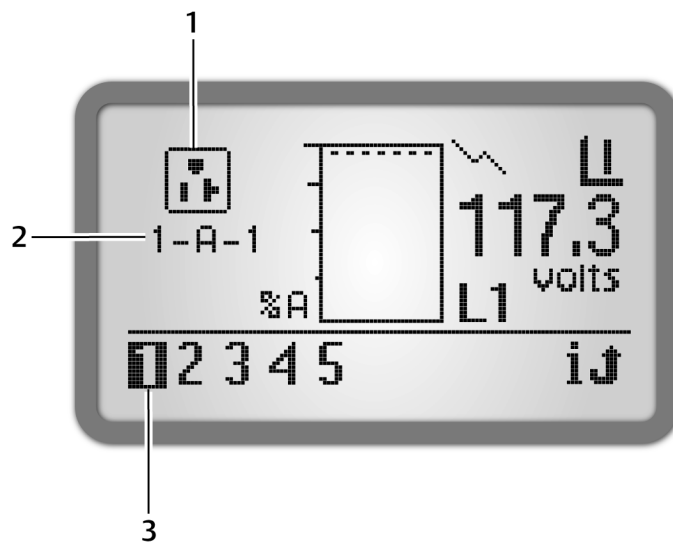

Number	Description
1	Receptacle-level information icon
2	Receptacle identification: 1 = MPH2 #1 A = Branch A 1 = Receptacle #1
3	Receptacle list (receptacle #1 of 5 is selected)

3.7 View Sensor Information

- At the input-level (main) screen, highlight the sensor icon, , and press . A list of the sensors, in the order of their identification number, displays, **Figure 3-15**.



NOTE

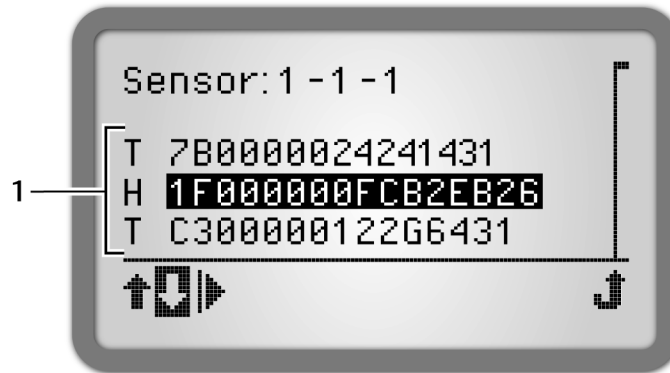

The default label is the sensor's serial number, but can be changed through the Web interface.

Figure 3-15 Sensor list



Number	Description
1	Sensors connected to the MPH2. (two temperature sensors and one humidity sensor in the example)

- Use the arrow keys to highlight an up/down arrow at the bottom-left, and press  to highlight a receptacle.

3. Highlight the play button, , and press .
The sensor information displays, similar to that shown in **Figure 3-16**, which shows humidity-sensor information:
 - Percentage and severity of humidity.
 - Sensor identification and label (serial number).



NOTE

The default label is the sensor's serial number, but can be changed through the Web interface.

Figure 3-16 Sensor information

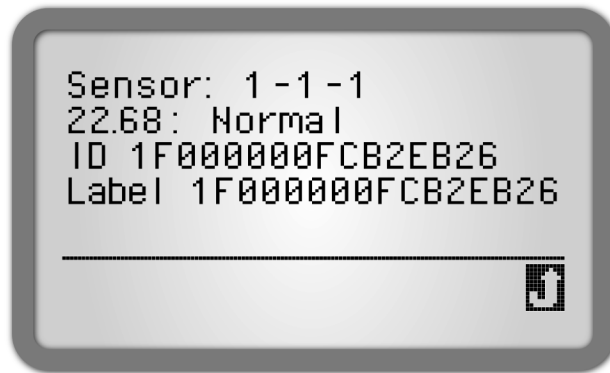

3.8 Opening and Closing Circuit Breakers

MPH2 Rack PDU feature circuit breakers to protect either branches or individual receptacles, depending on the model. Low-profile circuit breakers are used on all MPH2 Rack PDUs with two or three branch circuits. Standard-profile circuit breakers are used on MPH2 Rack PDUs with six branch circuits or have a 240VAC rating.

Both types of circuit breakers are flush-mount, rocker-style breakers. The circuit breakers are designed to prevent accidental trips. To manually trip a circuit breaker to the Off position, insert a flat-blade screwdriver or similar tool into the slot on the breaker as shown in **Figure 3-17**. To reset the breaker, press the end nearest ON until it clicks into place.

Figure 3-17 Turning Off or resetting a circuit breaker

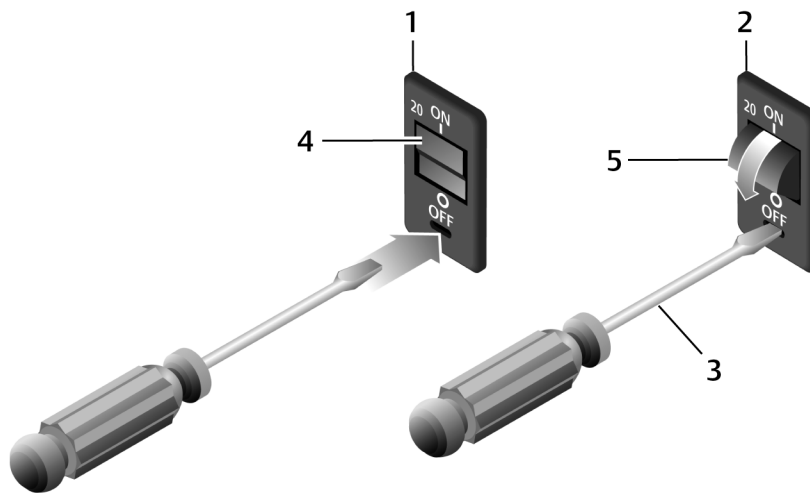

Number	Description
1	Low-profile breaker switch
2	Standard-profile breaker switch
3	Flat-blade screw driver. To trip breaker (low- or standard-profile), press screw driver into slot.
4	Press here to reset low-profile breaker.
5	Push top of breaker switch in to reset standard-profile breaker.

4.0 Emerson® MPH2 Rack PDU Specifications

	0-U	1-U	2-U
Input Power Configurations; Vary by Model and Region			
Single-Phase Input; CE-Mark			
240 VAC, 16 A; also UL-listed		3.7 kW	
230 V, 32 A		7.3 kW	
Three-Phase Input; CE-Mark			
230/400 V, 16 A		11 kW	
230/400 V, 32 A		22 kW	
Single-Phase Input; UL-Listed			
120 VAC, 12 A		1.4 kW	
120 VAC, 16 A		1.9 kW	
120 VAC, 24 A		2.9 kW	
208 VAC, 24 A		4.9 kW	
Three-Phase Input; UL-Listed			
120/208 VAC, 24 A		8.6 kW	
120/208 VAC, 40 A		14.4 kW	
120/208 VAC 48 A; 240/415 VAC, 24 A		17.3 kW	
Input Wiring Options	10-ft. (3-m) Non-Detachable Power Supply Cord Hard-Wired Terminal Block	10-ft. (3-m) Non-Detachable Power Supply Cord	
Receptacle Options	NEMA 5-15; NEMA 5-20; IEC 320C13; IEC 320 C19		
Number of Receptacles, Maximum	48	12	24
Power Consumption, Maximum	7.5 W		
Measurement Accuracy	Voltage: ±1% +0.1 VAC Current: ±1.5% + 0.01 A from 1% to 10% of unit rating; ±1% +0.01 A from >10% to 125% of unit rating		
Insulation	Class I, Reinforced SELV		
Dielectric Electric Strength	Tested up to 4242 VDC		
Overcurrent Protection	UL489-Listed, CSA, TUV, CCC Overcurrent Circuit Breaker, 20 A, 5000 A A.I.C		
Operating Temperature Range, °F (°C)	32-A or Less Input Models: 32 to 140 (0 to 60) 40-A and 48-A Input Models without case ventilation: 32 to 122 (0 to 50) 40-A and 48-A Input Models with case ventilation: 32 to 140 (0 to 60)		
Storage Temperature Range, °F (°C)	-13 to 185 (-25 to 85)		
Humidity,%	10 to 90 non-condensing		
Altitude, ft. (m)	6562 (2000)		
Mounting	Factory-Installed Tool-less Brackets Universal Mounting Bracket	Factory-installed, Right-angle Mounting Brackets	
Width x Depth, in. (mm)	Low-profile: 2.2 x 1.96 (56 x 50) Standard: 2.2 x 2.7 (56 x 70)	1.73 x 9.84 (44 x 250)	3.46 x 9.84 (88 x 250)
Units, Length, in. (mm)	13.1 - 72.2 (333 - 1833)	19 (482.6)	19 (482.6)
Safety Standards (Vary by Model and Region)	IEC 60950-1:2005 (Second Edition) + Amendment 1:2009 CSA C22.2 NO. 60950-1-07 (2nd Edition) + Amendment 1:2009 UL 60950-1 (2nd Edition) + Amendment 1:2009 IECEE CB Full Certification Scheme		
EMC Standards (Vary by Model and Region)	FCC Class A, Part 15, Industrial EN55022:2006+A1:2007, Class A, Industrial EN55024:1998+A1:2001+A2:2003, Class A, Industrial IEC61000-3-2:2014 (ed.3), IEC61000-3-3:2013 (ed.3) IEC61000-4-2/3/4/5/6/8/11 Note: A temporary loss of touch-key functionality may occur for sufficiently large radio-frequency fields induced through the power-supply cord.		
Agency Approvals (Vary by Model and Region)	UL, cUL, CE, BV, CB, RoHS, REACH, WEEE		

5.0 Troubleshooting



NOTE

Per UL 60950-1 2nd Ed. ITE safety-standard requirements, the current ratings of UL Listed models are 80% of input-plug, branch-circuit-breaker and receptacle maximum current ratings.

Table 5-1 Receptacle LED Troubleshooting

LED Indication (One or All LEDs)		Audible Alarm	Condition	Status/Recommended Action
Color	State/ Flash Speed			
Green	Steady On	—	Input-voltage-supported Receptacle Powered-on	Normal Operation
Green	Fast	—	Receptacle Identification	Remote user is requesting receptacle identification. The LED should stop flashing after 10 seconds.
Off	NA	—	Voltage Off	Check receptacle power control settings.
Green	Slow	—	Overcurrent Warning	Check for changing load conditions. Check overcurrent warning threshold settings.
Red	Fast	✓	Overcurrent Alarm	Check for changing load conditions. Check overcurrent alarm threshold settings.
			Undercurrent Alarm	Check for removal of load. Check undercurrent alarm threshold settings.
Red (All LEDs)	Pulse	—	Branch Circuit Breaker Open	Check for changing load conditions; confirm circuit breaker actuator is closed. If open, correct loading condition before pressing circuit breaker actuator closed again. Note: On single-phase, switched-receptacle models, this may indicate that the input-power line and neutral are swapped if there is no power to the unit.
Green (All LEDs)	Slow	—	Branch Overcurrent Warning	Check for changing load conditions. Check overcurrent warning threshold settings.
Red (All LEDs)	Fast	✓	Branch Overcurrent Alarm	Check for changing load conditions. Check overcurrent alarm threshold settings.

Table 5-2 Line LED Troubleshooting

LED Indication (One or All LEDs)		Audible Alarm	Condition	Status/Recommended Action
Color	State/ Flash Speed			
Green	Steady On	—	None	Normal Operation Note: Depending on plug type, not all LEDs may be lit, see Table 5-3 .
Off	NA	—	Voltage Off	Confirm that the LED is active per Table 5-3 . Check power source and input plug's receptacle wiring. Check receptacle power control settings.
Red	Steady On	✓	Line Undervoltage Alarm	Check power source for power quality problem. If the MPH2 uses 3-phase power, a single low-voltage phase may cause one or more undervoltage alarms. The undervoltage alarm is factory-set to -10% of the minimum input voltage range on the nameplate; it cannot be changed.
Red	Fast	✓	Overcurrent Alarm	Check for changing load conditions. Check overcurrent alarm threshold settings.
Green	Slow	—	Overcurrent Warning	Check for changing load conditions. Check overcurrent warning threshold settings.
Red	Fast	✓	Undercurrent Alarm	Check for removal of load. Check undercurrent alarm threshold settings.
Green/Red	Fast	—	Firmware Update	Firmware updated in-progress. LCD does not display information. If the update fails or aborts, the indication continues until firmware update is successful.

5.1 Additional Troubleshooting by Plug Type

Table 5-3 describes the line LEDs active by plug type. Depending on the type of plug, not all of the line LEDs may be lit. The table also describes the branch circuits/receptacle-type and corresponding input-power voltage phases.

Table 5-3 Active Line LEDs and Branch Voltage Phasing by Plug Type

Plug Type	Pole/Wire Config.	Receptacle Types		LEDs Active			Branch Voltage Phasing							
		NEMA 5-20	IEC C13/C19	L1	L2	L3	A	B	C	D	E	F		
NEMA 5-15P	1P3W	✓		✓			L1-N							
NEMA 5-20P	1P3W	✓		✓			L1-N							
NEMA L5-20P	1P3W	✓		✓			L1-N							
NEMA L5-30P	1P3W	✓		✓			L1-N	L1-N						
NEMA L6-20P	2P3W		✓	✓	✓		L1-L2							
NEMA L6-30P	2P3W		✓	✓	✓		L1-L2	L1-L2						
NEMA L14-30P	2P4W	✓	✓	✓	✓		L1-N	L1-L2	L1-L2					
NEMA L15-20P	3P4W		✓	✓	✓	✓	L1-L2	L2-L3	L3-L1					
NEMA L15-30P	3P4W		✓	✓	✓	✓	L1-L2	L2-L3	L3-L1					
NEMA L21-20P	3P5W		✓	✓	✓	✓	L1-L2	L2-L3	L3-L1					
	3P5W	✓	✓	✓	✓	✓	L1-N + L1-L2	L2-N + L2-L3	L3-N + L3-L1					
NEMA L21-30P	3P5W		✓	✓	✓	✓	L1-L2	L2-L3	L3-L1					
	3P5W	✓	✓	✓	✓	✓	L1-N	L2-L3	L2-L3					
NEMA L22-30P	3P5W		✓	✓	✓	✓	L1-N	L2-N	L3-N	L1-N	L2-N	L3-N		
CS8365C 50A	3P4W		✓	✓	✓	✓	L1-L2	L2-L3	L3-L1	L1-L2	L2-L3	L3-L1		
IEC 60309 1P3W 16A	1P3W		✓	✓			L1-N							
IEC 60309 1P3W 32A	1P3W		✓	✓			L1-N	L1-N						
IEC 60309 3P5W 16A	3P5W		✓	✓	✓	✓	L1-N	L2-N	L3-N					
IEC 60309 3P5W 32A	3P5W		✓	✓	✓	✓	L1-N	L2-N	L3-N	L1-N	L2-N	L3-N		
IEC 60309 3P4W 60A	3P4W		✓	✓	✓	✓	L1-L2	L2-L3	L3-L1	L1-L2	L2-L3	L3-L1		

Technical Support / Service

Web Site

www.liebert.com

Monitoring

liebert.monitoring@emerson.com

800-222-5877

Outside North America: +00800 1155 4499

Single-Phase UPS & Server Cabinets

liebert.upstech@emerson.com

800-222-5877

Outside North America: +00800 1155 4499

Three-Phase UPS & Power Systems

800-543-2378

Outside North America: 614-841-6598

Environmental Systems

800-543-2778

Outside the United States: 614-888-0246

Locations

United States

1050 Dearborn Drive

P.O. Box 29186

Columbus, OH 43229

Europe

Via Leonardo Da Vinci 8

Zona Industriale Tognana

35028 Piove Di Sacco (PD) Italy

+39 049 9719 111

Fax: +39 049 5841 257

Asia

7/F, Dah Sing Financial Centre

108 Gloucester Road, Wanchai

Hong Kong

852 2572220

Fax: 852 28029250

While every precaution has been taken to ensure the accuracy and completeness of this literature, Liebert Corporation assumes no responsibility and disclaims all liability for damages resulting from use of this information or for any errors or omissions.

© 2016 Liebert Corporation

All rights reserved throughout the world.

Specifications subject to change without notice.

® Liebert is a registered trademark of Liebert Corporation. All names referred to are trademarks or registered trademarks of their respective owners.

SL-20860_REV4_4-16

590-1330-501C

Emerson Network Power

Liebert

www.emersonnetworkpower.com