



# Liebert<sup>®</sup> iCOM<sup>™</sup>-S

## User Manual

v2.4.0

The information contained in this document is subject to change without notice and may not be suitable for all applications. While every precaution has been taken to ensure the accuracy and completeness of this document, Vertiv assumes no responsibility and disclaims all liability for damages resulting from use of this information or for any errors or omissions.

Refer to local regulations and building codes relating to the application, installation, and operation of this product. The consulting engineer, installer, and/or end user is responsible for compliance with all applicable laws and regulations relating to the application, installation, and operation of this product.

The products covered by this instruction manual are manufactured and/or sold by Vertiv. This document is the property of Vertiv and contains confidential and proprietary information owned by Vertiv. Any copying, use, or disclosure of it without the written permission of Vertiv is strictly prohibited.

Names of companies and products are trademarks or registered trademarks of the respective companies. Any questions regarding usage of trademark names should be directed to the original manufacturer.

### **Technical Support Site**

If you encounter any installation or operational issues with your product, check the pertinent section of this manual to see if the issue can be resolved by following outlined procedures.

Visit <https://www.vertiv.com/en-us/support/> for additional assistance.

# TABLE OF CONTENTS

<b>1 Important Safety Information</b> .....	<b>1</b>
<b>2 Introduction</b> .....	<b>3</b>
2.1 System Description and Configuration .....	3
2.2 System Component Descriptions .....	4
2.2.1 Vertiv™ Liebert® iCOM™-S Software on Pre-Loaded Touchscreen Panel Appliance .....	4
2.2.2 Vertiv™ Liebert® iCOM™-S Software on Pre-Loaded 1U Workstation Appliance .....	7
2.2.3 Vertiv™ Liebert® iCOM™-S Software Only .....	7
2.2.4 Vertiv™ Liebert® iCOM™-S Gateway RDU301 Appliance .....	7
2.2.5 Vertiv™ Thermal Units .....	8
2.2.6 Vertiv™ WSN Gateway and Sensors (Wireless) .....	8
2.3 Vertiv™ Liebert® iCOM™-S Software Requirements .....	8
2.3.1 Vertiv™ Liebert® iCOM™-S Software System Requirements—Panel Based Installation .....	8
2.3.2 Vertiv™ Liebert® iCOM™-S Software System Requirements—Server-Based Installation .....	9
2.3.3 Vertiv™ Liebert® iCOM™-S Room and Point Configurator Software System Requirements .....	9
2.3.4 Backup and Redundancy for Vertiv™ Liebert® iCOM™-S System Protection .....	9
2.3.5 Software Configuration Protection .....	10
2.3.6 Vertiv™ Liebert® iCOM™-S Included System Software .....	11
2.3.7 Vertiv™ Liebert® iCOM™-S Appliance Model Number Nomenclature .....	11
<b>3 Pre-installation Preparation</b> .....	<b>13</b>
3.1 Prepare Equipment Lists and Layout Documents .....	13
3.1.1 Room Graphic Considerations .....	13
3.1.2 Dimensions and Clearance .....	14
3.1.3 Cabling and Power Requirements .....	14
3.1.4 Metric and System Configuration Considerations .....	14
3.2 Field Networking Considerations and Scenarios .....	15
3.2.1 Common Considerations .....	15
3.2.2 Application Examples .....	15
3.2.3 Direct to 1U Application .....	16
3.2.4 Direct to Panel Application .....	17
3.2.5 Distributed to Panel Application .....	18
3.2.6 Distributed to Server Application .....	18
3.3 BMS Integration Considerations .....	19
3.3.1 Single IP for Data and Common Numbering Schemes .....	19
3.3.2 Metrics Configurations .....	19
3.4 Vertiv™ Liebert® iCOM™-S Gateway (RDU-301) Configuration .....	22
3.4.1 Configuring Vertiv™ Liebert® iCOM™-S Gateway (RDU-301) IP Addresses .....	22
3.5 Receiving and Handling .....	23
3.6 Storage Prior to Installation .....	23

- 3.7 Vertiv™ WSN Configuration ..... 23
- 4 Vertiv™ Liebert® iCOM™-S Device Installation ..... 25**
- 4.1 Vertiv™ Liebert® iCOM™-S Touch Screen Panel Appliance ..... 25
  - 4.1.1 Assembling the Universal Mounting Bracket ..... 25
  - 4.1.2 Wall Mount Installation ..... 28
- 4.2 Vertiv™ Liebert® iCOM™-S 1U Workstation Appliance ..... 29
  - 4.2.1 Wall Mount Installation ..... 31
  - 4.2.2 Rack Mount Installation ..... 32
  - 4.2.3 1U Power Up and Initial Connection ..... 32
- 4.3 Vertiv™ WSN Equipment ..... 32
- 4.4 (PA) Thermal Unit Configuration for Control ..... 33
  - 4.4.1 (PA) Control Sensor Configurations ..... 33
  - 4.4.2 (PA) Configuring Team Work Mode 3 ..... 35
  - 4.4.3 (PA) Auxiliary Air Temperature (AAT) Wireless Sensor Enablement ..... 36
  - 4.4.4 (PA) AAT Fallback Timer Operation ..... 36
  - 4.4.5 (PA) Configuration Wireless AAT for Teamwork Mode ..... 37
  - 4.4.6 (PA) Vertiv™ Liebert® iCOM™ Unit Level Operation — Redundancy ..... 38
- 4.5 (A9H) Thermal Unit Configuration for Control ..... 40
  - 4.5.1 (A9H) Control Sensor Configuration ..... 40
  - 4.5.2 (A9H) Remote THB Enablement ..... 41
  - 4.5.3 (A9H) Auxiliary Air Temperature (AAT) Wireless Sensor Input Enablement ..... 42
  - 4.5.4 (AH9) Configuration Wireless (AAT) for Teamwork Mode ..... 42
  - 4.5.5 (A9H) Vertiv™ Liebert® iCOM™ Unit Level Operation—Redundancy ..... 43
- 5 Software Setup ..... 45**
- 5.1 Viewing/Connecting Vertiv™ Liebert® iCOM™-S User Interface ..... 46
  - 5.1.1 Direct on Appliance ..... 46
  - 5.1.2 Remote Web Browser ..... 49
  - 5.1.3 Remote Windows Desktop ..... 49
- 5.2 Applying Your License ..... 49
  - 5.2.1 Export Panel Info ..... 50
  - 5.2.2 Import Panel Info ..... 50
  - 5.2.3 License via Cloud ..... 51
  - 5.2.4 System Restore ..... 51
  - 5.2.5 The Licensing Process ..... 51
- 5.3 Initial Quick Start Process ..... 52
  - 5.3.1 System Networking ..... 53
  - 5.3.2 Changing System User Password ..... 55
  - 5.3.3 Create a New User ..... 57
  - 5.3.4 Configuring the Windows Firewall ..... 59
  - 5.3.5 Additional First Login Activities ..... 60

5.3.6 Adding Objects to System .....	63
<b>6 Diagnostic Utility .....</b>	<b>65</b>
6.1 Diagnostic Utility Menu .....	65
6.2 Report Menu .....	65
6.3 Database Menu .....	66
6.4 Ops Log Menu .....	66
6.5 Diagnostic Zip .....	66
<b>7 Vertiv™ Liebert® iCOM™-S User Interface .....</b>	<b>69</b>
7.1 User Interface Layout .....	69
7.1.1 Title Bar .....	70
7.1.2 View Menu .....	72
7.2 Home .....	72
7.3 Reports .....	73
7.3.1 Reports .....	73
7.3.2 Scheduled Reports .....	73
7.3.3 Report Location .....	73
7.4 Connect and Control .....	73
7.4.1 Vertiv™ Liebert® iCOM™-S Connect .....	74
7.4.2 Vertiv™ Liebert® iCOM™-S Clusters .....	74
7.4.3 Vertiv™ Liebert® iCOM™ Groups .....	75
7.4.4 Wireless Gateways .....	78
7.5 Quick Start .....	79
7.5.1 Adding Objects to System .....	79
7.5.2 Adding a Vertiv™ Liebert® iCOM™-S Gateway (RDU301) .....	80
7.5.3 Adding Wireless Gateway .....	81
7.5.4 Adding Thermal Groups .....	82
7.5.5 Manually Adding Thermal HVAC Units .....	84
7.5.6 Adding a Chiller .....	85
7.6 System .....	87
7.6.1 System Information .....	87
7.6.2 User Access .....	90
7.6.3 Windows Firewall .....	94
7.6.4 Home Page Settings .....	95
7.6.5 BMS .....	97
7.6.6 SSL Certificate .....	98
7.6.7 Alerts and Defaults .....	98
7.6.8 Email Server Configuration .....	100
7.6.9 Site .....	101
7.7 Service .....	102
7.7.1 Vertiv™ Liebert® iCOM™-S Software .....	102

- 7.7.2 Backup/Restore ..... 103
- 7.7.3 Tools and Diagnostics ..... 103
- 7.7.4 Low Level Setting ..... 105
- 7.7.5 Diagnostic Zip ..... 105
- 7.7.6 Support ..... 105
- 7.8 Web UI ..... 105
  - 7.8.1 Home ..... 105
  - 7.8.2 Reports ..... 107
  - 7.8.3 Connect and Control ..... 108
  - 7.8.4 Service ..... 109
- 8 Room Editor Program ..... 113**
- 8.1 Getting Started ..... 113
- 8.2 Home Menu Bar ..... 113
- 8.3 Setting Up a Room ..... 115
  - 8.3.1 Placing Equipment ..... 115
  - 8.3.2 Editing Multiple Items at Once ..... 117
- 8.4 View Tab ..... 117
- 8.5 Colors Tab ..... 118
- 8.6 Exporting to Vertiv™ Liebert® iCOM™-S ..... 118
- 9 BMS Integration ..... 119**
- 9.1 Points Schema Modbus ..... 119
- 9.2 Points Schema BACnet ..... 120
- 10 Points Configurator Program ..... 121**
- 10.1 Points Configurator Menu Setting ..... 121
- 10.2 Using the Wizard to Configure Points ..... 122
- 10.3 Exporting the Points List for a BMS ..... 123
- 10.4 Lists of Points Available ..... 124
- 11 Software and License Updates ..... 129**
- 11.1 Manual Software Update ..... 129
- 11.2 Cloud Software Updates ..... 129
- 12 Frequently Asked Questions ..... 131**
- 12.1 Networking ..... 131
- 12.2 Pricing/Licensing ..... 132
- 12.3 Demos ..... 132
- 12.4 Vertiv™ Liebert® iCOM™-S Gateway (RDU301) ..... 133
- 12.5 Remote Connectivity ..... 134
- 12.6 BMS External Connectivity ..... 134
- 12.7 General Features ..... 135
- Appendices ..... 137**
- Appendix A: Technical Support and Contacts ..... 137

Appendix B: Submittal Drawings .....	139
Appendix C: Reports .....	141
Appendix D: Available BMS Points .....	147

This page intentionally left blank



# 1 Important Safety Information

## SAVE THESE INSTRUCTIONS

This manual contains important safety instructions that should be followed during the installation and maintenance of the Vertiv™ Liebert® iCOM™-S. Read this manual thoroughly before attempting to install or operate this unit.

Only professionally trained and qualified personnel should move, install, or service this equipment.

Adhere to all warnings, cautions and installation, operating and safety instructions on the unit and in this manual. Follow all operating and user instructions.



**WARNING! Risk of electric shock. Can cause property damage, injury, or death. This equipment has a grounding type plug that has a third (grounding) pin. This plug will fit only into a grounding type outlet. If the plug does not fit into an outlet, engage a qualified electrician to install a proper outlet. Do not alter the plug and do not use a two prong plug adapter.**



**WARNING! Risk of heavy unit falling. Can cause property damage, injury, or death. The Liebert® iCOM™-S can weigh more than 50 lb. (22.7 kg). Exercise caution when moving the Liebert® iCOM™-S, setting it in place and attaching it to a wall. Utilize a licensed professional structural engineer to evaluate the wall or intended mounting surface and recommend the proper fasteners to maximize the strength and long term reliability of the attachment of the Liebert® iCOM™-S to the intended wall or mounting surface.**

**IMPORTANT! Risk of data loss or corrupted data. Can cause improper operation. Failure to maintain minimum clearances between data wires and input power wires may cause interference in the data wires.**

**IMPORTANT! Risk of data loss. Can cause improper operation. All Liebert® iCOM™-S data should be backed up on an external memory device. Backing up the Liebert® iCOM™-S data and settings on an external memory device protects against hard drive failures and other causes of lost settings. Backups can be used to reinstall the Liebert® iCOM™-S configuration and return the monitoring and management systems to service.**

**NOTE: The Liebert® iCOM™-S configuration backup file does not protect the operating system of the iCOM™-S PC.**

**IMPORTANT! Risk of use of improper software. Doing so can cause degraded computer performance. Only software approved specifically by Vertiv may be installed on the Liebert® iCOM™-S. Installing non-approved software may affect the performance of the user interface and backend services and may void the warranty.**

**NOTE: Branch circuit protection must be provided by the installer.**

This page intentionally left blank

## 2 Introduction

### 2.1 System Description and Configuration

The Vertiv™ Liebert® iCOM™-S monitors and manages environmental conditions in data centers and its unique combination of hardware and software is especially suited for incorporating small to large rooms, multi-room, and single multi-floor sites. Liebert® iCOM™-S is configurable for wireless only monitoring (a connection is still required for the wireless gateways), for thermal management unit monitoring and/or control, and is scalable for anything in between.

**Figure 2.1 Liebert® iCOM™-S**

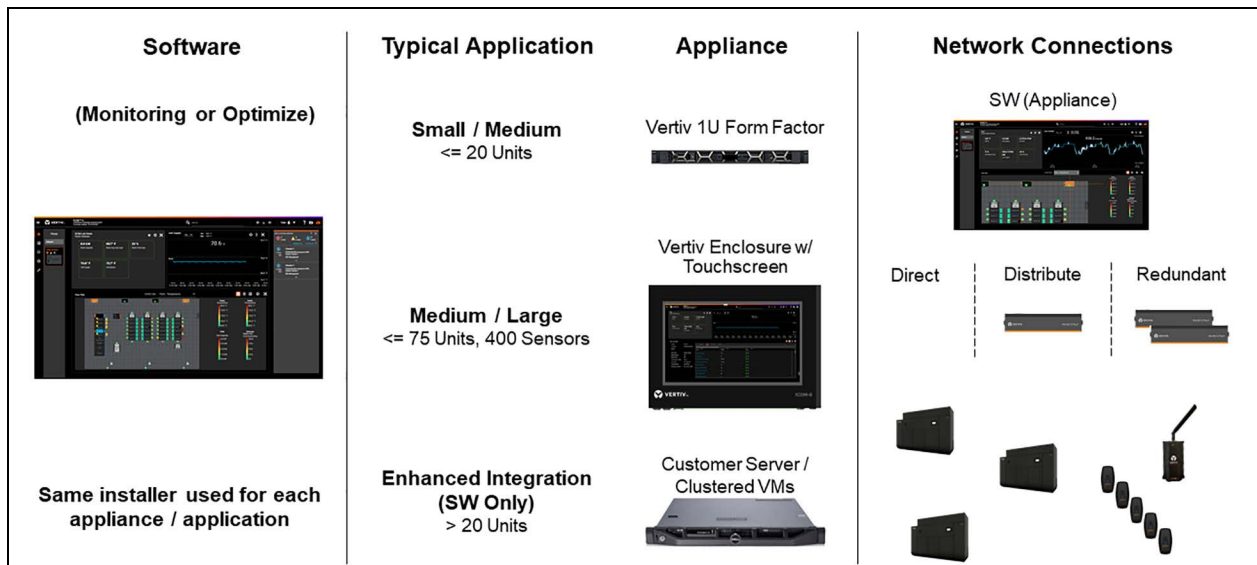

Liebert® iCOM™-S operates in two modes:

- Monitoring mode monitors networked Liebert Thermal Management units and provides an aggregated/single BMS IP connection point for upstream systems.
- Optimize mode responds to monitored sensor readings based on programmed setpoints keeping the conditioned spaces at an optimal state while also allowing modification of available connected thermal unit set points.

Using the monitored data, Liebert® iCOM™-S dynamically reports information and status of the managed space in color coded, graph, image, and numeric views.

Liebert® iCOM™-S 1U Workstation is capable of monitoring and managing a network of 75 networked Liebert thermal management units and eight wireless gateways (with 300 wireless sensors max per gateway). Connection to downstream devices is done through external network devices.

Liebert® iCOM™-S Panel Appliance is capable of monitoring and managing a network of 75 networked Liebert® thermal management units and eight wireless gateways (with 300 wireless sensors max per gateway). With the available 23 (internal switch) networking ports, up to 11 individual cooling units equipped with Liebert® iCOM™-S large monochrome displays or 22 with color or small monochrome displays can be connected without additional Vertiv™ Liebert® vNSA panels or network switches when no wireless gateways are connected into the panel.

Connectivity limits of the Liebert® iCOM™-S Software Only application is dependent on multiple factors so contact the factory or your Vertiv sales representative for specific scenario specification and verification.

**Table 2.1 Vertiv™ Liebert® iCOM™-S Configuration**

Application	Function	Included Features			
		Unit Monitoring	Unit Control	Wired Temperature Sensors	Wireless Temperature Sensors
Wired	Setup 1. Thermal unit monitoring only (no space temperatures).	✓			
	Setup 2. Thermal unit monitoring and wired temperature sensors	✓		2T sensor data (wired into units)	
	Setup 3. Thermal unit monitoring and control and wired temperature sensors	✓	✓	2T sensor data (wired into units)	
Wireless	Setup 1. Thermal unit monitoring only (no space temperatures).	✓			
	Setup 2. Thermal unit monitoring and wireless temperature sensors	✓			✓
	Setup 3. Thermal unit monitoring and control and wireless temperature sensors	✓	✓		✓

**NOTE:** Wired and wireless sensors can be used together for monitoring and unit control.

When using wireless sensors, it is recommended to include wired sensors for redundancy.

## 2.2 System Component Descriptions

### 2.2.1 Vertiv™ Liebert® iCOM™-S Software on Pre-Loaded Touchscreen Panel Appliance

A keyboard and mouse are included with Liebert® iCOM™-S for use during setup. The touchscreen and virtual keyboard on Liebert® iCOM™-S are for everyday operation.

Figure 2.2 on the facing page displays the Liebert® iCOM™-S internal components.

Figure 2.2 Vertiv™ Liebert® iCOM™-S Panel Appliance Internal Components

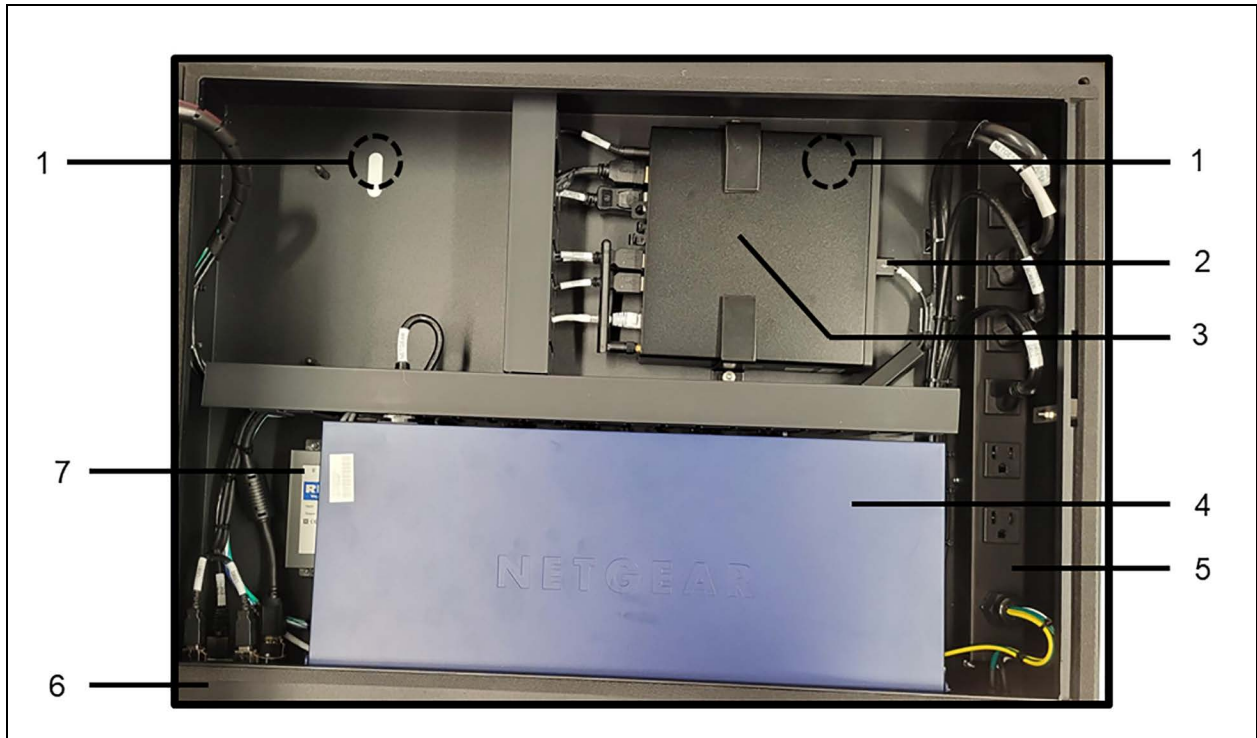

Table 2.2 Liebert® iCOM™-S User Manual Display Connections Inside Front Door

Item	Description	Item	Description
1	Thumb screw, attaches mounting bracket	5	Power supply for iCOM-S components
2	USB drive	6	Panel- covers USB, HDMI and power ports and wiring (see <b>Figure 2.3</b> on the next page )
3	Server - 16 GB RAM, 256 GB SSD storage (standard)	7	Power supply for wireless gateways
4	24-port Ethernet switch		

**Figure 2.3** on the next page displays the connections on the Liebert® iCOM™-S touchscreen monitor mounted inside the front door of the iCOM™-S.

Figure 2.3 Vertiv™ Liebert® iCOM™-S Display Connections Inside Front Door

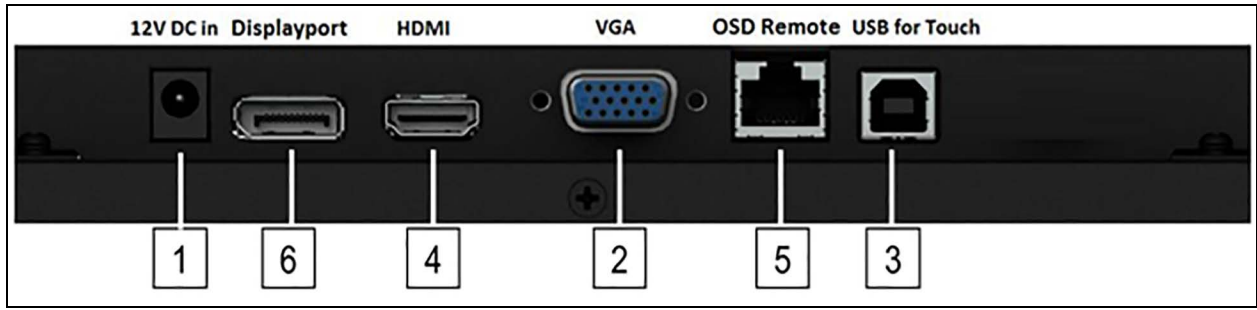

Table 2.3 Liebert® iCOM™-S User Manual Display Connections Inside Front Door

Item	Description	Item	Description
1	12 VCD power input	4	HDMI Input
2	VGA video input	5	RJ-45 OSD connector (See note below.)
3	USB touchscreen output	6	Display port

**NOTE:** Only plug the included monitor remote into the RJ-45 OSD connector. If you plug any other Ethernet cable into this port, the monitor turns-off and the remote will be required to turn it back on.

Figure 2.4 below describes the connections on the bottom, front of the Liebert® iCOM™-S.

Figure 2.4 Liebert® iCOM™-S Bottom Panel Connection

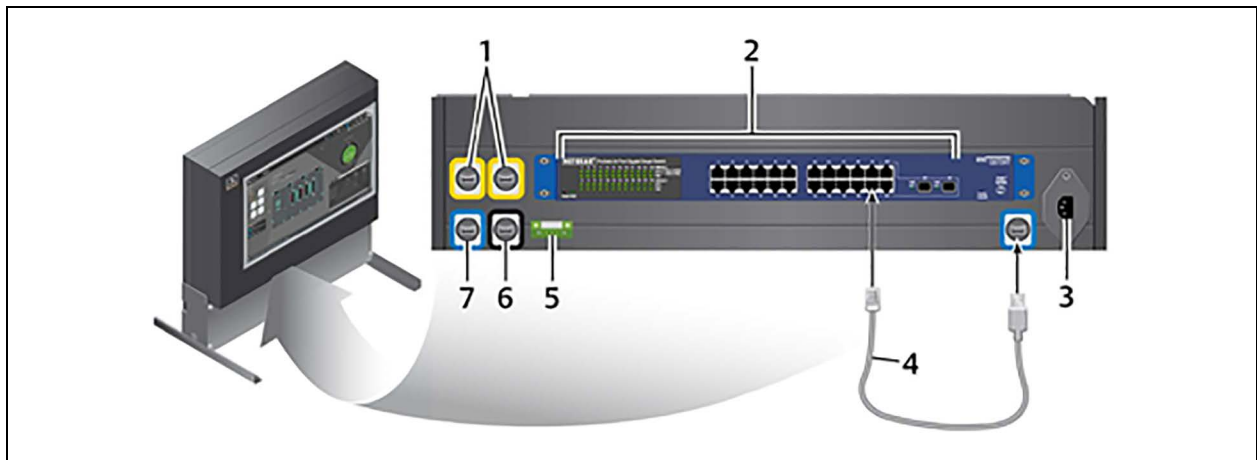

Table 2.4 Liebert® iCOM™-S User Manual Bottom Panel Connections

Item	Description	Item	Description
1	USB ports	5	24V power terminal block
2	24 port Ethernet switch	6	HDMI port
3	Input power connections	7	Ethernet port
4	Ethernet connection to internal router		

## 2.2.2 Vertiv™ Liebert® iCOM™-S Software on Pre-Loaded 1U Workstation Appliance

The Vertiv 1U Workstation Appliance is designed for smaller systems where the end user does not desire to mount a full Liebert® iCOM™-S panel (detailed in [Vertiv™ Liebert® iCOM™-S Software Only](#) below ) on the wall, or does not have a large enough system to justify a server-based install, but still wants to take advantage of all the benefits and cost savings an iCOM™-S system has to offer. The Vertiv 1U Workstation Appliance is designed to mount into a server rack and user access is accomplished through the established building network. The 1U workstation can also be mounted on an optional 1U wall mount bracket for access either through network or via display adapters.

**Figure 2.5 1U Workstation Appliance**



## 2.2.3 Vertiv™ Liebert® iCOM™-S Software Only

The Liebert® iCOM™-S can be installed on a customer provided desktop, server or VM which is then networked to the end-device network for communication. Liebert® iCOM™-S operates using three included software packages:

- Liebert® iCOM™-S Integral Software (iIS) monitors and manages the conditioned space. See [Vertiv™ Liebert® iCOM™-S User Interface](#) on page 69 information about navigating the menu.
- Room Editor manages floor plans representing conditioned spaces for accurate/efficient monitoring and/or control. See [Room Editor Program](#) on page 113 about navigating the Room Editor Software.
- Points Configurator allows the user to enable and configure the data that is communicated from Liebert® iCOM™-S to a connected, third-party monitoring system. See [Points Configurator Program](#) on page 121 about navigating the Points Configurator Software.

## 2.2.4 Vertiv™ Liebert® iCOM™-S Gateway RDU301 Appliance

The Liebert® iCOM™-S Gateway (RDU301) allows for cross network/subnet device connectivity and additional calculation compute capabilities. The Liebert® iCOM™-S Gateway can assist greatly in software only (server based) applications on separate networks or when there is the need to duplicate IP or Group/U2U ID addresses across rooms in the same building on their own private networks.

The Liebert® iCOM™-S Gateway runs distributed functionality provided by the iCOM™-S software. Various proprietary device protocols and calculation engines are deployed dynamically based on the application and then managed by the Liebert® iCOM™-S. When the quick start wizard is used to add devices to the system, the Liebert® iCOM™-S will automatically deploy the required functionality for the user. If redundancy, via clustered/parallel (N+M) Liebert® iCOM™-S Gateways is required, the iCOM™-S will manage the functionality to maintain uptime by recognizing network/power outages and will automatically remove/re-distribute functionality to try to restore communication and calculations to restore these offline devices.

The Liebert® iCOM™-S Gateway can also be run in parallel to the iCOM™-S as an additional compute node with no end-devices connected. This allows offloading of system calculations from the Liebert® iCOM™-S server to the iCOM™-S Gateway.

The Liebert® iCOM™-S software not only allows this initial deployment but also re-configuration of existing network components and scenarios easily through a dedicated user interface.

## 2.2.5 Vertiv™ Thermal Units

Vertiv thermal units are available in many different types including room, in-row, and rack cooling. Below is a list of compatible units.

**Table 2.5 Compatible Vertiv™ Thermal Units**

iCOM Hardware	Display Type	SW Family	Units	Min. Display FW	Min Controller FW	Rec. (Latest) Controller RW
iCOM™1 Large	Small/Large Monochrome	A9H	EMEA PDX/PCW	A9H1.04.42R	A9H1.04.42R	A9H1.04.46R
iCOM™1 Medium	Small/Large Monochrome	CR	CRV	CR2.03.28R	CR2.03.28R	CR.2.05.02R
iCOM™1 Large	Small/Large Monochrome	PA	DS/VS, CW, DSE	N/A	PA2.01.48R	PA2.06.59R
iCOM™1 Large	9" Resistive	PA	CW, DS/VS, DSE, PDX/PCW, MMVC	N/A	PA2.04.32R	PA2.06.59R
iCOM™2	7" Capacitive	PA	CW, DS/VS, DSE, PDX/PCW, MMVC	N/A	PA2.04.32R	PA2.06.59R
iCOM™3	7" Capacitive	V1A	PDX/PCW	N/A	V1A1.01.001R	V1A1.01.008R
iCOM™3	7" Capacitive	V1C	AFC	N/A	V1C1.01.001R	V1C1.01.009

Refer to the installation guides included for thermal unit setup. Ensure all units are correctly installed before Vertiv™ Liebert® iCOM™-S installation.

## 2.2.6 Vertiv™ WSN Gateway and Sensors (Wireless)

Vertiv™ Wireless Sensor Network (WSN) provides an effective and secure method for data center thermal monitoring that reduces deployment costs and network complexity. The platform is easily deployed and scalable from small monitoring environments to large multi-room mission critical control applications. A single deployed gateway can communicate to 300 wireless sensors collecting environmental data.

## 2.3 Vertiv™ Liebert® iCOM™-S Software Requirements

### 2.3.1 Vertiv™ Liebert® iCOM™-S Software System Requirements—Panel Based Installation

Standard Liebert® iCOM™-S Panel characteristics:

- Windows 10 Pro
- Intel i5-8500T or higher
- 16 GB RAM (2666 MHz) or higher
- 256GB SATA Class 20 SSD or higher



## 2.3.2 Vertiv™ Liebert® iCOM™-S Software System Requirements—Server-Based Installation

Server/VM OS Requirements:

- Windows 10 Pro, Windows Server 2016 / 2019

Typical Server/VM Characteristics (larger distributed application support):

- Minimum dual Xenon (CPU E5-2630 v3 @ 2.4GHz, 8 cores, 16 logical processors, 32 GB RAM).
- 256 SSD minimum (RAID configurations handled on customer end).
- SQL Server Standard 2017 - 2019 for remotely connected instances.

## 2.3.3 Vertiv™ Liebert® iCOM™-S Room and Point Configurator Software System Requirements

Software System Requirements:

- Windows 10 or newer
- 8 GB RAM, minimum
- Intel i3 processor

## 2.3.4 Backup and Redundancy for Vertiv™ Liebert® iCOM™-S System Protection

The Liebert® iCOM™-S software follows a service-oriented architecture. When the operating system boots, all background services continue. The system collects data and trends, performs calculations, and serves as the control and heartbeat of communication without running the Liebert® iCOM™-S user interface.

By default, Liebert® iCOM™-S restarts automatically when power is restored after a power failure, resuming the last powered state. Background services take approximately 1 minute to resume operation.

The thermal unit alert after loss of the Liebert® iCOM™-S signal is typically set for 15 seconds plus 180 seconds before the thermal-management units switch to redundant modes of operation and alarm.

The redundancy mode depends on the Liebert® iCOM™-S component that lost power:

1. **If the Liebert® iCOM™-S internal hard drive loses power and the network switch remains powered—**thermal management units switch back to normal Liebert iCOM™ Teamwork operation. The units on a Teamwork network use any wired 2T temperature sensors on that network as the fan-speed-control sensor. Wireless temperature-sensor data is not available until all components are powered up and communicating. If no sensor data is available, the units resort to operating at 100% (or modified fall back value) fan speed with local cooling control.
2. **If the entire Liebert® iCOM™-S unit loses power (including switch)—**Depending on networking upstream and power state, thermal-management units may or may not operate in Teamwork operation mode using wired 2T temperature sensors:
  - a. If upstream thermal management units are networked through a powered Vertiv™ Liebert® vNSA or another powered network switch, they operate as described in Item 1 above.
  - b. If upstream thermal management units are not networked, units switch to stand-alone operation using their own wired temperature sensors as the fan speed control sensor.
  - c. If the supply air temperature sensor and wired 2T temperature sensor of the upstream thermal management units are lost, the units resort to the return air temperature sensor as the fan speed control sensor.

- d. If upstream thermal management units lose all internal and external sensors, the fans operate at 100% (equivalent fan energy of non-VSD/EC units).

**NOTE: Vertiv recommends installing at least one wired, 2T sensor per unit, and a minimum of two 2T sensors per group, to ensure that the space temperatures are available for unit control if a problem occurs with the wireless system.**

### 2.3.5 Software Configuration Protection

The Vertiv™ Liebert® iCOM™-S Software has a configuration backup process called Full System Backup. The Full System Backup exports a full system file, including historical monitored data and system configuration. By default, the full system backup file is saved every morning at 5 a.m. in the C:\RDU\DatabaseBackup folder on the Liebert® iCOM™-S. A configuration backup (system configuration without historical data) is saved in addition to this at the same time on an external USB drive when plugged in (ships with the panel and 1U workstation).

Figure 2.6 Full System Backup

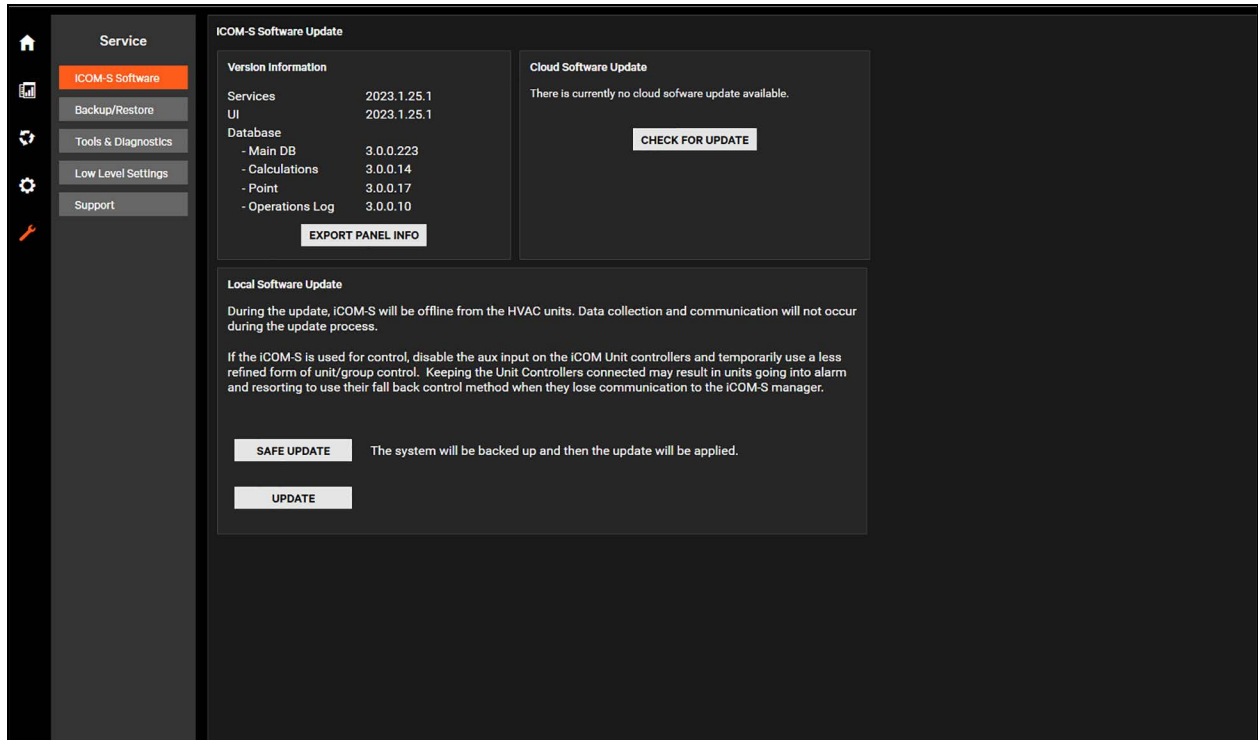

When the SQL Server is on a separate virtual or physical machine, the Remote SQL Backup Location and SQL Server Backup Path need filled in to be able to process a Full System Backup. The Windows service user account needs access permissions to the Remote SQL Backup Location. The Remote SQL Backup Location needs to be accessible from the Liebert® iCOM™-S Server. SQL Server needs access permissions to the SQL Server Backup Path. The SQL Server backup path only needs to be accessible from the SQL Server.

## 2.3.6 Vertiv™ Liebert® iCOM™-S Included System Software

The Liebert® iCOM™-S can be installed on a customer provided desktop, server or VM which is then networked to the end-device network for communication iCOM™-S operates using three included software packages:

- **Liebert® iCOM™-S Integral Software** (iIS) monitors and manages the conditioned space. See [Vertiv™ Liebert® iCOM™-S User Interface](#) on page 69 information about navigating the menu.
- **Room Editor** manages floor plans representing conditioned spaces for accurate/efficient monitoring and/or control. See [Room Editor Program](#) on page 113 about navigating the Room Editor Software.
- **Points Configurator** allows the user to enable and configure the data that is communicated from Liebert® iCOM™-S to a connected, third-party monitoring system. See [Points Configurator Program](#) on page 121 about navigating the Point Configurator Software.

## 2.3.7 Vertiv™ Liebert® iCOM™-S Appliance Model Number Nomenclature

This section describes the model-number configuration for Liebert® iCOM™-S units and components.

**Table 27** on the next page describes each digit in the model number.

**Table 2.6** Liebert® iCOM™-S

1	2	3	4	5	6	7	8	9	10	11	12	13	14	15	16	17	18	19	20	21	22	23	24	25
S	U	P	2	2	K	0	0	0	0	0	0	0	0	0	0	0	0	0	0	0	A	P	P	L

The model number is the first 10 digits plus the last 4 digits of the configuration number.

**Table 2.7 Model Number Digit Definitions**

Digits	Description
Digits 1-3	<b>Liebert® iCOM™-S Appliance</b>
SUP	Supervisory appliance pre-loaded with Liebert® iCOM™-S software
Digit 4	<b>Display Size, Inches</b>
00	No display (1U appliance)
22	22 in. touchscreen display (panel enclosure)
Digit 6	<b>Power/Voltage Supply</b>
Q	100-240VAC 1Ph / 50-60Hz (1U appliance)
K	120V 1Ph / 60 Hz (Panel enclosure only)
Digit 7	<b>Power Options</b>
0	Single power supply (default)
2	Dual power supply (1 U appliance only)
Digit 8	<b>Future Options</b>
0	N/A
Digit 21	<b>Packaging</b>
0	US/Canada
Digit	<b>Factory Configuration Number</b>
APPL	Appliance

When the software only option is selected and no appliance is being ordered, ICOMSSW is the part number used on the Line Item Details. This is an electronic delivery of the latest software available to a factory Vertiv technician performing the required Vertiv factory installation/configuration of the Vertiv™ Liebert® iCOM™-S software.

## 3 Pre-installation Preparation

Refer to the following procedures to properly prepare to install hardware, configure components, and setup software applications for Vertiv™ Liebert® iCOM™-S.

### 3.1 Prepare Equipment Lists and Layout Documents

Users should have a list of all their thermal equipment and review the preparation and installation manuals for all devices. Users should additionally plan for room graphics, dimensioning and clearance of the units, and cabling and power requirements for all the units.

#### 3.1.1 Room Graphic Considerations

Vertiv™ Liebert® iCOM™-S monitors and controls thermal management units on the network without a floor plan but setting up floor plans greatly simplifies managing the conditioned spaces and increases operating efficiency by providing environmental visibility.

Before beginning installation, obtain and prepare the following:

- A list of all the equipment in each conditioned space and its location in the space including:
  - Thermal management units with their model number and type.
  - Racks and the number of aisles.
  - Quantity and location of wireless gateways.
  - Quantity and location of wired and wireless sensors.
- The dimensions of each conditioned space:
  - Length (up and down).
  - Width (side to side).
  - Ceiling height (floor to ceiling).
  - Raised floor height. (Is there a false bottom where you can pull up tiles to access wires or pumps?) This is usually 2 to 3 ft.
  - Above ceiling height, if applicable.
- High-resolution (300 dpi) images of room and/or section layouts of the conditioned space that include room dimensions, raised floors, and placement of all equipment, wireless gateways, and sensors.
- Accepted formats are .jpg, .bmp and .png.
  - Highly recommend .png files because they are vector based, relatively small, and preserve transparency.
- The recommended maximum size is 3,000 x 3,000 pixels.
- The minimum size is 1,000 pixels for at least one side of the image.
- IP/subnet addresses and group/unit ID of connected Liebert® iCOM™ controlled thermal management units. The auto-discovery function fills in the IP/unit firmware version if the thermal-management units are on the same/correct network with the Liebert® iCOM™-S system.
- Agreement on sensor size/layout, including preferred corner radius.
- IP/subnet addresses of the Vertiv™ WSN Wireless Gateway.
- IP/subnet addresses of the Liebert® iCOM™-S Gateways.

**IMPORTANT! Each IP address and Group ID must be unique on the same network. Do not duplicate addresses unless the units are on different networks (utilizing the Liebert® iCOM™-S Gateway).**

### 3.1.2 Dimensions and Clearance

For the panel appliance, the dimensions of the assembled panel mount universal mounting bracket are:

- Width = 26.4 in. (671 mm)
- Height = 25.75 in. (635 mm)
- Footprint = 26.5 in. (664.2 mm) wide x 16 in. (407 mm) deep

For the panel appliance, both wall- and desk-mount configurations, the following clearances apply:

- Up to 24 in. (610 mm) on the left side to accommodate the DIN rail (because it may be extended to mount ancillary equipment).
- 27 in. (660 mm) in front of the system to open the front door.
- 6 in. clearance required for cable management.

Refer to submittal DPN003318 in [Submittal Drawings](#) on page 139 for more details on size.

In wireless configurations consider:

- In open space with clear line-of-sight, the wireless gateway has a receiving range of more than 1,000 ft. (305m). In traditional data center applications with dense/metal obstructions however, it is recommended to maintain a radius of 200 ft. (61m) or less between the wireless gateway and communicating wireless sensors to increase sensor strength, decrease signal to noise ratio and to increase battery life.
- Use best practices for optimal results in locating wireless gateways: do not install directly behind obstructions, on other side of walls or at a right angle to the floor, inside metal enclosures. It is also recommended to position the antenna at a right angle to the data center floor.

### 3.1.3 Cabling and Power Requirements

- Install Vertiv™ Liebert® iCOM™-S within 328 ft (100 m) of the furthest unit/device to be connected via Ethernet cable, including wireless gateways and iCOM™-S displays on the cooling units. Greater distances require signal amplifiers or powered repeating/network switches.
- Provide duplex 110-120V, 60Hz input power protected by a dedicated circuit breaker. Vertiv recommends a 120-VAC source within 5 ft (2 m) of the Liebert® iCOM™-S. A 3 ft (0.9 m) and 6 ft (1.8 m) power cable ships with iCOM™-S.
- Vertiv also recommends installing a UPS/battery backup power feed.
- The Liebert® iCOM™-S panel appliance includes a single power feed that needs to have branch circuit protection upstream. The Liebert® iCOM™-S 1U workstation appliance can be ordered with an optional second power supply pre-installed where two independent power feeds can be connected to the appliance directly.

### 3.1.4 Metric and System Configuration Considerations

- Agreement with the end user on desired system calculations to perform at the Unit, Group, Room and Site levels. Refer to [Metrics Configurations](#) on page 19 for available calculations at the various levels.
- BMS points to be mapped (as metrics/calculations have to be enabled for the results to be available for communication).
- Known site altitude as this set value impacts calculation results.
- Agreed upon list of unit data points to include in the initial Room Report view.

## 3.2 Field Networking Considerations and Scenarios

### 3.2.1 Common Considerations

When designing the layout of the conditioned space, plan the cabling and wiring runs for the Ethernet and other cabling that will connect and network Vertiv™ Liebert® iCOM™-S with the cooling units and peripheral devices.

Consider the following:

- Good wiring practices.
- Ethernet CAT5 or greater cable is required.
- An Ethernet repeater is required for cable lengths greater than 328 ft (100 m).
- A private network that only manages and monitors the cooling units is required.
- Keep control and communication cables away from power cables to prevent interference.
- Keep cables away from noise introducing devices such as machines, fluorescent lights, and electronics.
- If Ethernet cabling must be run in close proximity to power cables, shielded Ethernet cable should be considered.
- Do not bend cables to less than 4 times the diameter of the diameter of the cable.
- Do not deform cables when hanging or securing in bundles.
- Do not exceed 25 lb. (11 kg) of tension when pulling cables to avoid stretching.
- Do not damage cables when securing them. Use only approved hangers, such as telephone wire/RG-6 coaxial-wire hangers.
- To protect and support cables routed through the panel appliance mounting bracket, a 1-1/2 in. conduit may be routed through the sides and bottom of the mounting bracket.
- Use grommets when routing cables through sharp knockouts.

### 3.2.2 Application Examples

The Vertiv™ Liebert® iCOM™-S allows for very flexible layouts and application use cases for the site. The next sections describe some of the example cases for software, room size, appliances, and network configurations. Below shows helpful configurations and some guidelines for each system.

Figure 3.1 Vertiv™ Liebert® iCOM™-S Application Examples

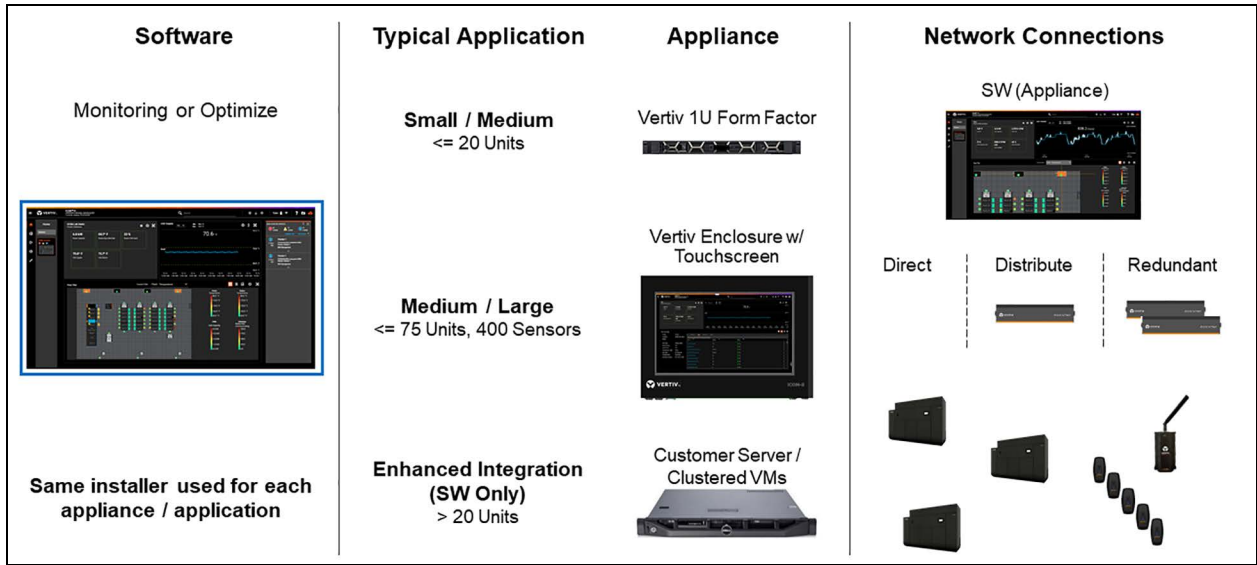

Liebert® iCOM™-S is the software for all applications. The software can be selected/licensed as either Monitoring or Optimized. The software can then be either pre-loaded/licensed on a Vertiv provided 1U workstation or touchscreen panel appliance. In applications where the customer requires the loading of the software on their own provided desktop server or VM, a software only instance of Liebert® iCOM™-S can be installed by qualified Vertiv service technicians. Then, depending on the application and networking requirements, end-devices can be connected to the Liebert® iCOM™-S appliance either directly (direct or through network switches) or indirectly through distributed iCOM™-S Gateway devices which provide network segregation and redundancy capabilities. Below, some of the more common applications are called out specifically.

### 3.2.3 Direct to 1U Application

Typical applications seen with the 1U workstation are for deployments that are less than 20 thermal units. This 1U appliance will be networked to end-device thermal units and wireless gateways through a field supplied and powered network switch (since the 1U only has one device network Ethernet port).

The below figure shows an example of a direct to Vertiv 1U form factor appliance with a small application. The customer has a monitoring package with a Vertiv™ Liebert® iCOM™-S 1U workstation appliance directly connected to the units.



Figure 3.2 Direct to 1U Application

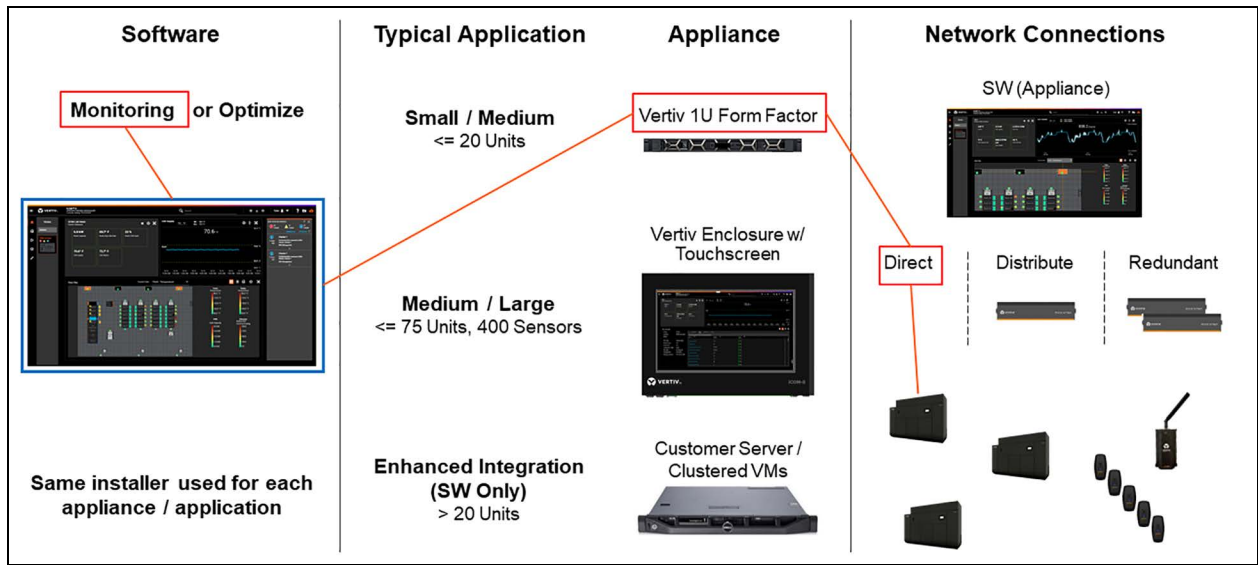

### 3.2.4 Direct to Panel Application

In a direct to panel application, the installation has a Vertiv supplied Liebert® iCOM™-S panel. The Liebert® iCOM™-S panel already has a computer, switch, and a touch screen integrated into it along with other components listed in [Vertiv™ Liebert® iCOM™-S Software on Pre-Loaded Touchscreen Panel Appliance](#) on page 4 .

In a direct to panel application, generally the thermal units are directly wired to the switch that is integrated into the Liebert® iCOM™-S panel. When more switch ports are needed, or the cable length would be too great, generally a Vertiv™ Liebert® vNSA model switch would be added in this type of application. A direct application does not offer redundancy and all calculations are completed in the Liebert® iCOM™-S panel.

Figure 3.3 below shows an example of direct to panel installation in a small/medium application. The customer has a monitoring package with a Vertiv panel directly connected to the units and a Vertiv™ WSN Gateway.

Figure 3.3 Direct to Panel Application

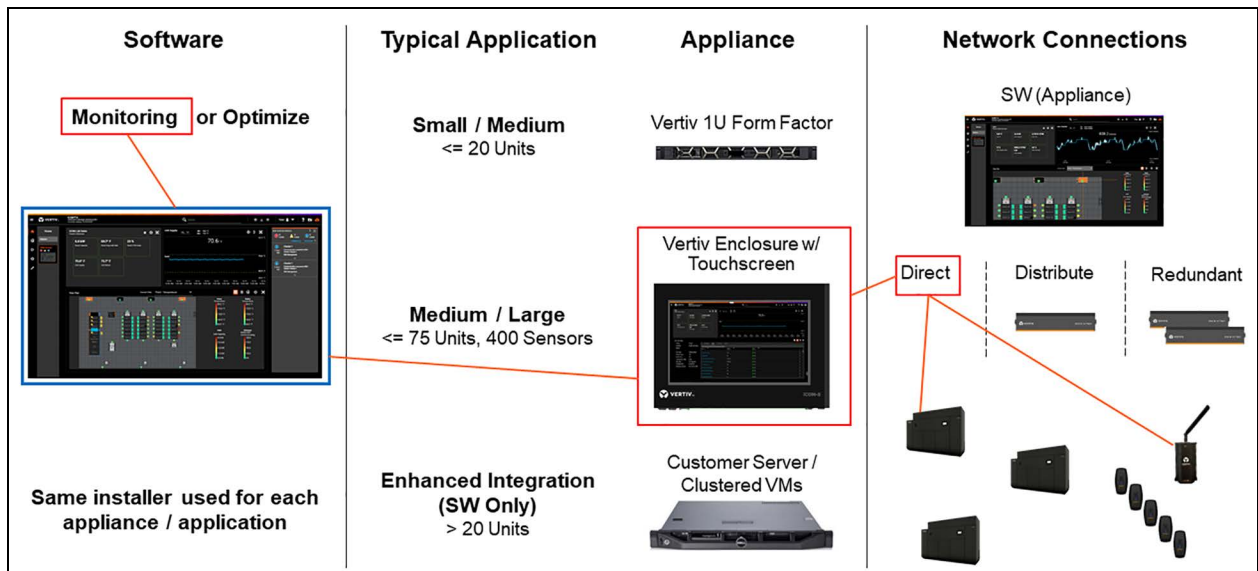

### 3.2.5 Distributed to Panel Application

In a distributed to panel application, the installation has a Vertiv supplied iCOM™-S panel and at least one iCOM™-S RDU-301 Gateway system for networking and calculations. In any distributed environment, a minimum of one iCOM™-S RDU Gateway is required, but it is highly recommended to have two or more.

Having two or more Liebert® iCOM™-S RDU-301 Gateways in the system provides redundancy – if one Gateway fails, the load is automatically transferred to another available Gateway. Having multiple Gateways also allows load balancing where the calculations and communications are balanced among all available Gateways in a cluster. This further removes processing load from the server running the Liebert® iCOM™-S application.

The thermal units are networked to Liebert® iCOM™-S Gateway clusters. The Liebert® iCOM™-S Gateways are then networked to the switch that is integrated into the iCOM™-S panel.

Figure 3.4 below shows an example of a distributed to panel installed in a medium application. The customer has an optimized software package with a Vertiv panel and redundant Liebert® iCOM™-S Gateways connected to the units.

Figure 3.4 Distributed to Panel Application

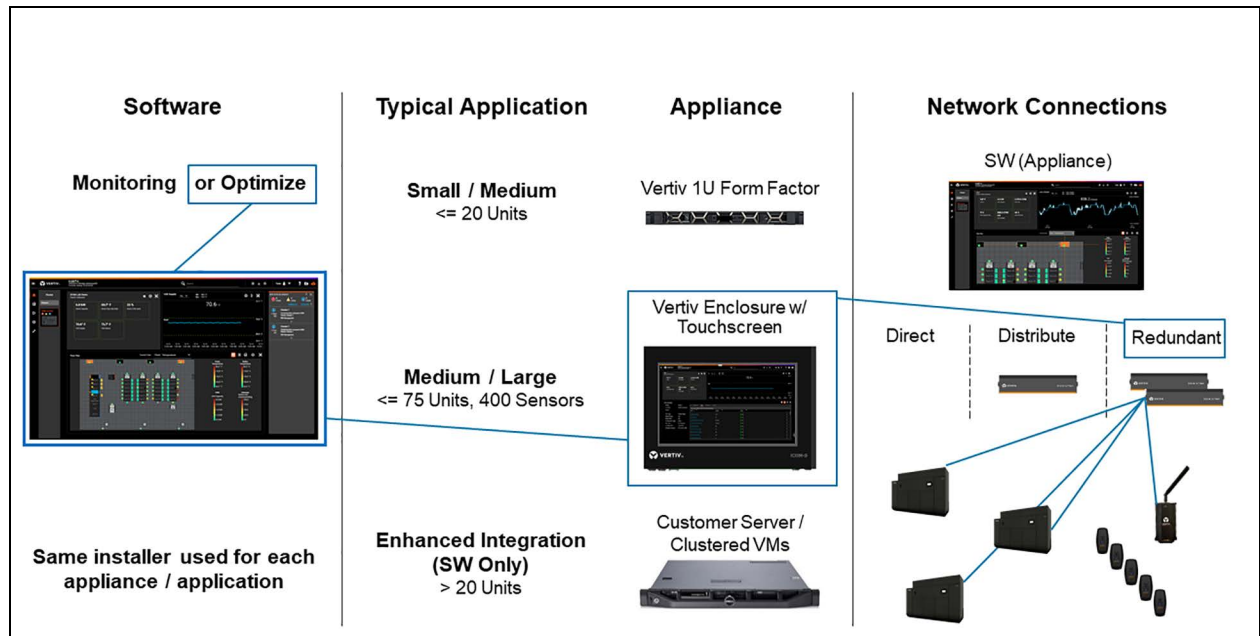

### 3.2.6 Distributed to Server Application

In a distributed to server application, the installation has at least Vertiv™ Liebert® iCOM™-S RDU-301 Gateways for networking and calculations. The customer will use their servers for the Liebert® iCOM™-S software. In any distributed environment, a minimum of one Liebert® iCOM™-S Gateways is required, but it is highly recommended to have two or more.

Figure 3.5 on the facing page shows an example of a distributed to server application. The customer has an optimized software package with redundant Liebert® iCOM™-S Gateways connected to the units. Also included in this configuration is a Vertiv™ WSN Wireless Gateway and WSN Wireless Sensors.

Figure 3.5 Distributed to Server Application

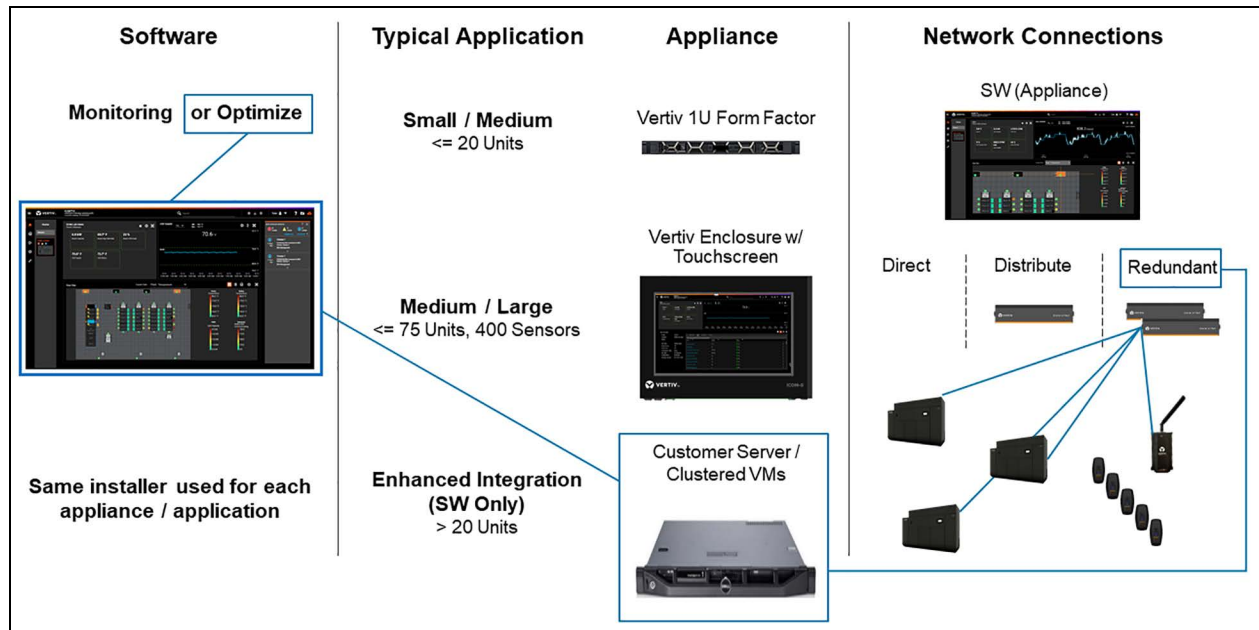

## 3.3 BMS Integration Considerations

### 3.3.1 Single IP for Data and Common Numbering Schemes

One major benefit of using Vertiv™ Liebert® iCOM™-S is the simplification of BMS integrations. The Liebert® iCOM™-S aggregates data and adds in device and supervisory level (room, group, and site) metrics and alarms into a single IP address that can communicate to connected BMS/BAS clients via Modbus or BACnet IP. Given the variance of connected device quantities, types, applications and configurations, the Liebert® iCOM™-S allows the user to enable and then configure the points they care about. Modbus registers and BACnet instance IDs can be customized to standard user templates/numbering schemes.

It is important to understand if a standard BMS point numbering scheme is known and should be used or if the connected BMS client has no preference and is just looking for a final points list for integration.

### 3.3.2 Metrics Configurations

Metrics are calculations made by the Vertiv™ Liebert® iCOM™-S system based on available data or other calculations. Metrics can provide valuable insights into the operation of cooling units and help to determine data center efficiency. Available metrics should be discussed with the site manager prior to system start-up.

The following metrics are available and can be: Enabled & Displayed, Enabled Not Displayed, or Not Enabled. Displayed indicates they are viewable in the UI (user interface). All metrics can be enabled. To enable metrics, drag them from one box to another and click **Save**. If specific metrics are not needed, they should be set as Not Enabled to prevent them from using unnecessary system resources. See [Home Page Settings](#) on page 95.

## HVAC Unit Metrics

- **Unit Capacity (Required):** Total capacity of an HVAC unit to provide cooling.
- **Unit Capacity Used:** % of total HVAC unit capacity available in use.
- **Unit Airflow (Required):** Unit supply fan capacity available.
- **Unit Airflow Used:** % used of total unit CFM available.
- **Unit Airflow Effectiveness:** Unit cubic feet per minute of supply air provided per kilowatt used.
- **Unit dT:** Temperature delta across supply and return.
- **Unit Efficiency:** Unit thermal efficiency – CTs required.

## Chiller Unit Metrics

- Chiller Capacity
- Chiller dT
- Chiller Efficiency

## Chiller Group Metrics

- Chiller Group Avg Flow
- Chiller Group Avg Inlet Water
- Chiller Group Avg Outlet Water
- Chiller Group Capacity
- Chiller Group dT
- Chiller Group Max Flow
- Chiller Group Max Outlet Water
- Chiller Group Total Flow

## Chiller Loop

- Chiller Loop Avg Flow
- Chiller Loop Avg Inlet Water
- Chiller Loop Avg Outlet Water
- Chiller Loop Capacity
- Chiller Loop dT
- Chiller Loop Max Flow
- Chiller Loop Max Outlet Water
- Chiller Loop Total Flow

## Group Metrics

Selected metrics will be displayed in the box grid on the main page.

- **Group Avg Cold Aisle:** Average temperature readings of a group of cold aisle sensors.
- **Group Max Cold Aisle:** Maximum temperature readings of a group of cold aisle sensors.
- **Group Min Cold Aisle:** Minimum temperature readings of a group of cold aisle sensors.
- **Group Avg Hot Aisle:** Average temperature readings of a group of hot aisle sensors.

- **Group Airflow:** Group supply fan capacity available.
- **Group Dew Point:** Calculated dew point for a specified group of HVAC units.
- **Group RH:** Calculated relative humidity for a specified group of HVAC units.
- **Group Static:** Pressure (static air pressure for a specified group of HVAC units).
- **Group Unit Return (Required):** Group unit return temperature sensor average.
- **Group Unit Supply (Required):** Group unit supply sensor temperature average.
- **Group Capacity:** Total capacity of a group of HVAC units to provide cooling.
- **Group Capacity Used:** Group cooling capacity used.
- **Group Airflow Avail:** Group supply fan capacity available above used.
- **Group Airflow Used:** % used of total group CFM available.
- **Group Airflow Effectiveness:** Group cubic feet per minute of supply air provided per kilowatt used.
- **Group Efficiency:** Group thermal efficiency – CTs required.
- **Group HVAC Power:** Total group current measured at the cooling units – CTs required.
- **Group Unit dT:** Group temperature difference across supply and return sensors.

## Room Metrics

Selected metrics will be displayed in the box grid on the main page.

- **Room Avg Cold Aisle:** Average temperature readings of cold aisle sensors in a room.
- **Room Avg Hot Aisle:** Average temperature readings of hot aisle sensors in a room.
- **Room Max Cold Aisle:** Maximum cold aisle sensor temperature in the room.
- **Room Min Cold Aisle:** Minimum cold aisle sensor temperature in the room.
- **Room Airflow:** Room supply fan capacity available.
- **Room Dew Point:** Calculated dew point for a specified room of HVAC units.
- **Room RH:** Room relative humidity.
- **Room Static Pressure:** Room average static pressure reading.
- **Room Unit Return (Required):** Room unit return temperature sensor average (weighted average).
- **Room Unit Supply (Required):** Room unit supply sensor temperature average (weighted average).
- **Room Capacity:** Total net sensible cooling capacity of connected HVAC units in the room.
- **Room Capacity Used:** Percentage of available connected HVAC unit capacity in use.
- **Room Airflow Avail:** Available CFM of connected HVAC units in the room.
- **Room Airflow Used:** Percentage of available CFM currently in use by connected HVAC units.
- **Room Airflow Effectiveness:** Room cubic feet per minute of supply air provided per kilowatt used.
- **Room Efficiency:** Room thermal efficiency – CTs required.
- **Room HVAC Power:** Total HVAC unit power measured at the cooling units in the room – CTs required.
- **Room Unit dT:** Room temperature difference across supply and return sensors.

## Site Metrics

Four are selectable for graphical display on the main screen. The remaining metrics will be displayed in the box grid on the main page.

- **Site Airflow:** Total site cubic feet per minute of air generated by supply fans.
- **Site Airflow Available:** Total site CFM supply fan potential minus current demand.

- **Site Airflow Used:** Percentage of cubic feet per minute used of total site CFM potential.
- **Site Airflow Effectiveness:** Site cubic feet per minute of supply air provided per kilowatt used.
- **Site Capacity:** Total capacity of the site HVAC units to provide cooling.
- **Site Capacity Used:** % of total site cooling capacity in use.
- **Site Efficiency:** Site thermal sensible net efficiency – CTs required.
- **Site Cold Aisle:** Average of sensor temperatures categorized as cold aisle.
- **Site Hot Aisle:** Average of sensor temperatures categorized as hot aisle.
- **Site HVAC Power:** Total site HVAC unit power measured at the cooling units – CTs required.

## 3.4 Vertiv™ Liebert® iCOM™-S Gateway (RDU-301) Configuration

The Liebert® iCOM™-S Gateway is a generic appliance that can be used for multiple applications. When connected to a Liebert® iCOM™-S system, it needs to be running FW version 2.1.5). Depending on how the Liebert® iCOM™-S Gateway appliance was sourced/sold, it is possible the image loaded is not 2.1.5. If the image is below 2.1.5, the flashing process described below should be completed prior to configuration and adding to the iCOM™-S system.

### 3.4.1 Configuring Vertiv™ Liebert® iCOM™-S Gateway (RDU-301) IP Addresses

The final IP addresses for the Liebert® iCOM™-S Gateway should be known before proceeding with these configuration steps.

1. Reboot the Liebert® iCOM™-S Gateway (**CTRL + ALT + DELETE**).
2. Log in as the admin user with the unique device password (first eight characters of the UUID number printed on the sticker located on the bottom of the device). Enter characters all lower case.
3. In the text-based Command Line Interface (CLI) select **Option #3: Ethernet**.
  - a. If nothing loads, wait one to two minutes for the network Interface ports to come online.
4. For configuring LAN #1 (left Ethernet port), choose Option #1 (enp2s0).
  - a. Typically, LAN #1 is the northbound network (either to private Liebert® iCOM™-S network for panel/1U applications or corporate/operations network for customer server/VM applications).
  - b. LAN #2 is the southbound private device network (CRACs, CRAHs, Vertiv™ WSN Gateways) in all applications
5. Choose **Option #1** for updating IPv4.
6. Select Static then configure the IP, GW and Subnet.
  - a. If no GW is needed, then set same as IP.
  - b. LAN #1 and LAN #2 should not be put on overlapping networks/subnets.
7. Repeat steps 4 - 6 , except choose LAN #2 (**enp3s0**) option in Step 4 , respectively.
8. Reboot device for settings to be saved (**CTRL + ALT + DELETE**)
  - a. Port properties will not display until active Ethernet connection present on port.

Figure 3.6 Configuring Vertiv™ Liebert® iCOM™-S Gateway IP Address

```

Select  0: Top Menu                (Refresh)
        1: Administrative (Set Time, Restart, Password, Firmware, etc.)
        2: Network Protocol      (Enable/Disable, Port, etc.)
        3: Ethernet              (LAN IPv4, IPv6, Name Servers, etc.)
        4: Diagnostics          (View Log, Ping)
        5: Help
        X: Exit

:: Select [0-5|s]: 3

```

**NOTE:** After configuring the network settings, reboot the Liebert® iCOM™-S Gateway and check settings. There have been instances that the network settings were blank after configuration. Having an active Ethernet connection on the port should force the set IP to display.

## 3.5 Receiving and Handling

Upon receiving the Vertiv™ Liebert® iCOM™-S system and before unpacking:

1. Verify that labeled equipment matches the bill of lading.
2. Inspect all items for visible and concealed damage. Report any damage immediately to the carrier and send a copy of the filed damage claim to Vertiv or your sales representative.
3. Optional items shipped separately or loose are included on the packing list.
4. You may also refer to the submittal (provided by your sales representative) that lists all the components shipped in addition to the Liebert® iCOM™-S and also indicates field supplied components.

## 3.6 Storage Prior to Installation

All Vertiv™ Liebert® iCOM™-S system components must be stored in a clean, dry, temperature-controlled environment and protected from damage.

## 3.7 Vertiv™ WSN Configuration

Important Vertiv™ WSN information and instructions specifically related to the integration into the Vertiv™ Liebert® iCOM™-S will be covered in this document. The instructions below are the steps required to prepare the WSN Gateway to be integrated into a Liebert® iCOM™-S system.

In-depth description and instructions for Vertiv™ WSN wireless equipment is covered in the WSN User Manual found here:

<https://www.vertiv.com/4aa20e/globalassets/products/monitoring-control-and-management/monitoring/vertiv-wireless-sensor-network-wsn-installeruser-guide.pdf>

1. Power on the Vertiv™ WSN Gateway by connecting power.
  - a. This is done by providing power through either the included wall power adapter or through the remote mounting kit transformer (instructions per submittals).
2. Default IP addresses are https://192.168.1.10 and https://192.168.2.10 for Ethernet ports #1 (left) and #2 (right) respectively (with top being branded face).
3. Default/first time login credentials are admin/admin but require a password change on first login.

**NOTE: Depending upon how old the firmware is, you may go straight to the web interface without being prompted for credentials after accessing either IP address listed above.**

4. Navigate to the System -> IP Config menu to set the IP address properties for the applicable ports.
  - a. Typically port #1 is used for the northbound connection to the private network either directly to the Liebert® iCOM™-S or iCOM™-S Gateway private (southbound) networks.
5. Click **Save**.
  - a. If the IP address being used for connection to the gateway has been changed to a different network, the IP address on the PC must be changed to be on that network to re-connect to the new gateway IP address.
6. Reconnect to the gateway at the new IP address and log in (if applicable).
7. Navigate to the System -> Date & Time menu to set the current **UTC** time.
8. To add wireless sensors directly to the Wireless Gateway Web User Interface:
  - a. Navigate to the Devices menu and select/flip the **WSNConnect** slider button to On. On older firmware, this is called **Flex Connect**.
  - b. Push the white **V** button on the front of a wireless Vertiv™ WSN-FLEX sensor to have it securely join the wireless gateway network. The Vertiv™ WSN sensor lights will oscillate and the sensor will emit a double beep when connection is successful.
9. When all desired sensors have been added, flip the **WSNConnect** slider button to **Off**.



## 4 Vertiv™ Liebert® iCOM™-S Device Installation

A specific order for equipment/hardware installation is not required. However, equipment must be fully installed and functional to be recognized by Liebert® iCOM™-S during initial setup.

See [Software Setup](#) on page 45.

### 4.1 Vertiv™ Liebert® iCOM™-S Touch Screen Panel Appliance

Install the Liebert® iCOM™-S in a clean, well-ventilated area that is free from significant temperature and humidity fluctuations. Before connecting any power or communication wiring, complete the physical installation of the Liebert® iCOM™-S by hanging on a wall or mounting on a table/desk. Depending on the application, Liebert® iCOM™-S and accessory devices may require installation in a secure area with shielded cables along with other security measures.

#### 4.1.1 Assembling the Universal Mounting Bracket

The mounting bracket may be installed on a wall or a desk/tabletop. In both cases, the main cage is installed on the two rear mounting posts, and the Vertiv™ Liebert® iCOM™-S sets in a recess on the main cage. **Figure 4.1** below shows the components of the universal mounting bracket. The feet are not used in wall mount applications, only for tabletop mounting.

**Figure 4.1** Mounting Bracket Components

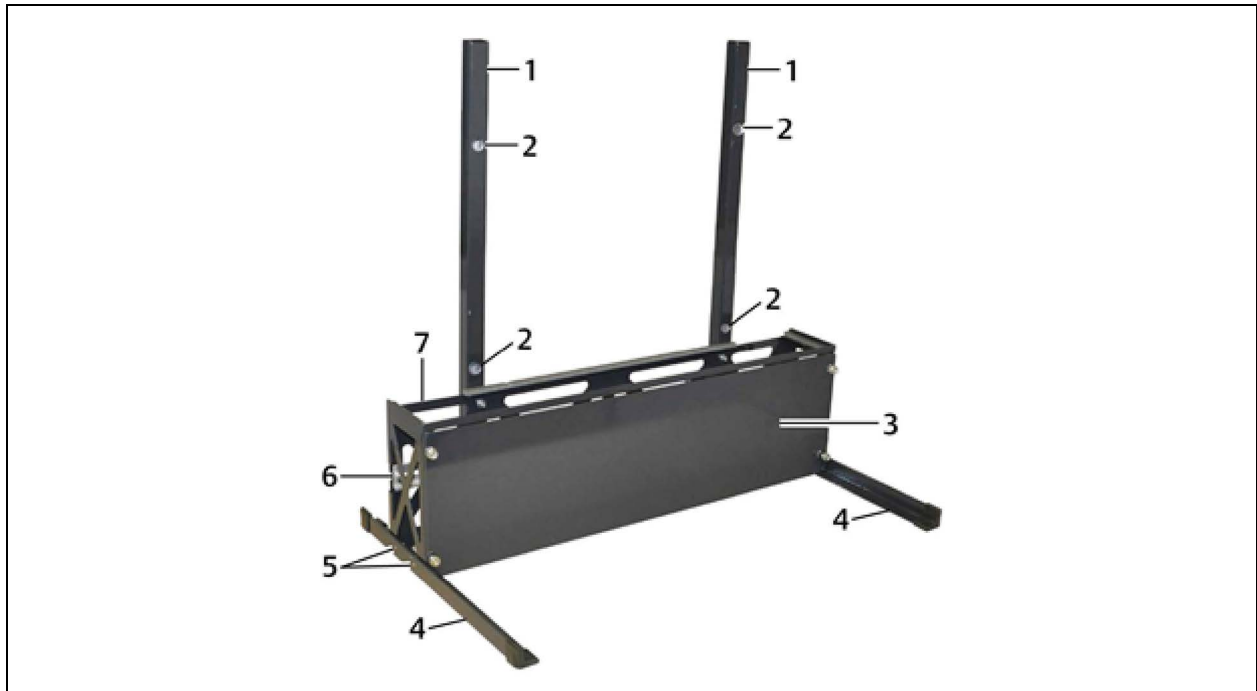

**Table 4.1 Mounting Bracket Components**

Item	Description	Item	Description
1	Rear mounting posts	5	Foot mounting screw locations (two each side)
2	Wall attachment holes	6	DIN rail (not extended)
3	Cable/port cover panel	7	Main cage
4	Desk mount foot		

To assemble the mounting bracket:

1. On a flat surface, lay the rear mounting posts parallel to each other.
2. Refer to **Figure 4.1** on the previous page and lay the main cage on the posts and align the mounting holes on the cage with those on the posts.

Figure 4.2 Bracket Assembly

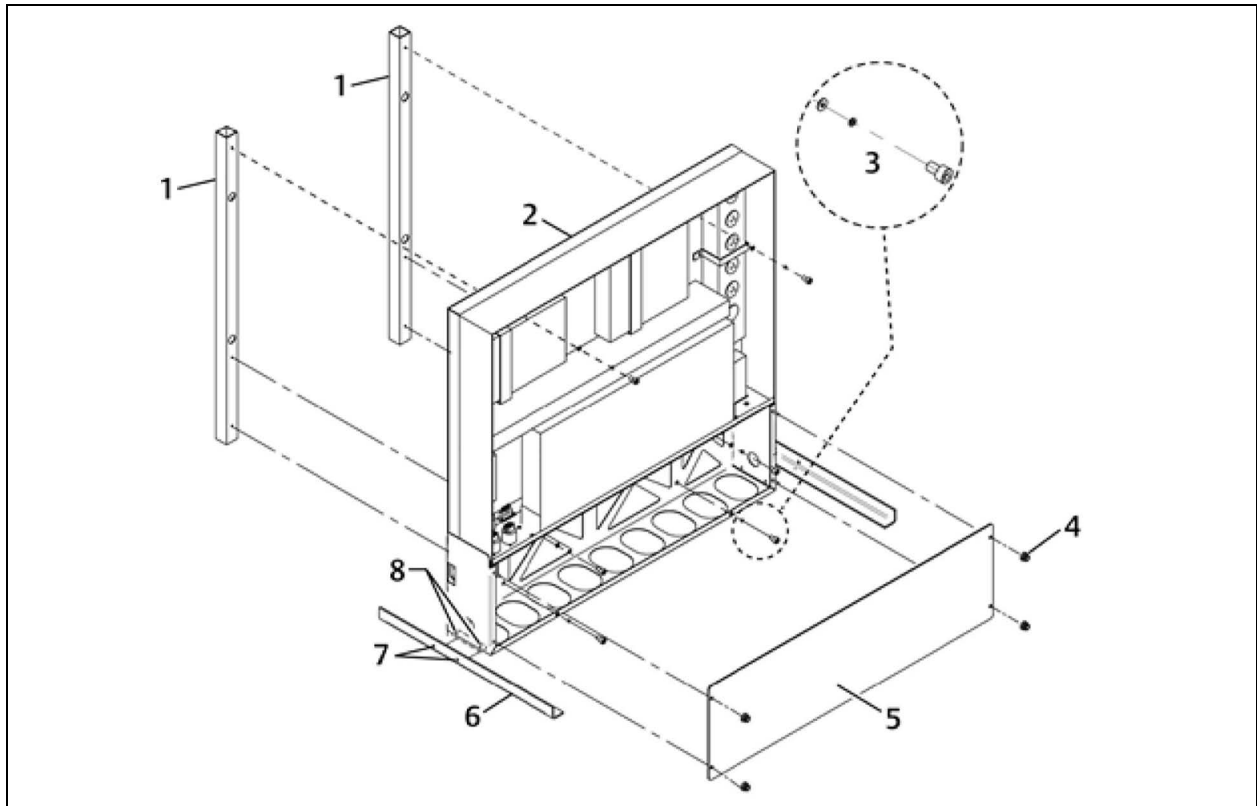

Table 4.2 Bracket Assembly

Item	Description	Item	Description
1	Rear mounting posts	5	Cable/port cover plate
2	iCOM™-S unit	6	Desk-mount foot (one each side)
3	3mm (M4) Allen screw, lock washer, and flat washer (two each side)	7	Cap screw, lock washer, flat washer (two each side)
4	Knurled thumb nuts	8	Threaded holes for foot attachment

3. Using the Allen head screws and washers, attach the main cage to the rear mounting posts.
  - a. If mounting Liebert® iCOM™-S on a wall, refer to [Wall Mount Installation](#) on the next page on the next page.
  - b. If mounting on a desk/tabletop, continue with Step 4 .
4. Attach the feet to the threaded holes on each side of the main cage as shown in **Figure 4.2** above .
5. Lift the Liebert® iCOM™-S module and set it atop the main cage, leaning it against the rear mounting post. The bottom of the module is cradled in a recess on top of the main cage.
6. Open the front door of the Liebert® iCOM™-S module and align the mounting holes in the module with those on the rear mounting posts.

7. Use the Allen head screws and washers to secure the module to the posts through the back of the module in four locations as shown in **Figure 4.2** on the previous page, then close the front door.
8. Place the cover panel on the four bolts on the front main cage and attach using the four factory-supplied knurl thumb nuts.
9. Attach the locking input power cable to the bottom panel of the Liebert® iCOM™-S, but do not connect to input power at this time.

## 4.1.2 Wall Mount Installation



**WARNING! Risk of heavy unit falling over. Can cause property damage, injury, or death. The Vertiv™ Liebert® iCOM™-S panel appliance weighs more than 50 lb. (23 kg). Two people may be required to assemble and mount the unit. Exercise caution when moving the unit, setting it in place and attaching it to a wall. The unit could fall, striking personnel.**

**The mounting surface must be strong enough to support the Liebert® iCOM™-S and the strain that occurs when its front door is open. Utilize a licensed professional engineer to evaluate the mounting surface and recommend the proper fastening method and mounting hardware.**

Field-supplied tools required:

- Carpenter's level
- Stud finder
- Framing square
- Electric drill with drill bits to match the size of the mounting screws
- Screw driver with tip to match the head of mounting screws
- Tape measure
- Pan head sheet metal screws

To mount Liebert® iCOM™-S on a wall:

1. Refer to [Dimensions and Clearance](#) on page 14 and verify that the mounting location has the required space and clearance.
2. Use the stud finder to locate the center of two, adjacent studs and mark the centers.
3. Measure and verify that the centers are 16 in. (406 mm) apart.

**NOTE: All mounting screws must be installed in a stud to bear the weight of the Liebert® iCOM™-S. The unit weighs more than 50 lbs. (23 kg) when all equipment and peripheral devices are installed.**

**If the wall studs are not 16 in. (406 mm) apart, securely attach a support to the studs, such as a 3/4 in. (19 mm) thick piece of plywood to the studs. The Liebert® iCOM™-S is mounted to this support.**

4. Drill a small hole into a stud to determine if it is wood or metal.
  - a. **If the studs are wood:** Use field supplied, 2-1/2-in. x #10 or #12, coarse thread pan head screws.
  - b. **If the studs are steel:** Use field supplied, #12, fine thread pan head screws long enough to penetrate 3/4 in. (19 mm) into the stud.
5. Using a carpenter's level, draw a plumb line 1/2 in. (12.7 mm) to the left of the stud and approx. 72 in. (1829 mm) above the floor. This is where the top of the mounting posts should be for a standing person to use Liebert® iCOM™-S.

6. Place a framing square on the plumb line so that the 16 in. (406 mm) leg of the square is tight against the plumb line, and the 24 in. (610 mm) leg extends to the next wall stud.
7. Draw a line along the horizontal leg of the framing square, then hold the mounting bracket against the wall with the top of the posts along the drawn line and mark the four mounting holes (two on each side).

**NOTE: The wall studs or support surface must be strong enough to bear the weight of the Liebert® iCOM™-S. The unit weighs more than 50 lb (23 kg) when all equipment and peripheral devices are installed.**

## 4.2 Vertiv™ Liebert® iCOM™-S 1U Workstation Appliance

This section is used to help with installation of the Liebert® iCOM™-S 1U Workstation Appliance.

Below are the dimensions of the 1U Workstation Appliance with a length of 22.4 in. (569 mm), width of 19 in. (482 mm), and a height of 1.7 in. (43mm). The unit can be wall mounted or rack mounted.

Figure 4.3 1U Workstation Appliance

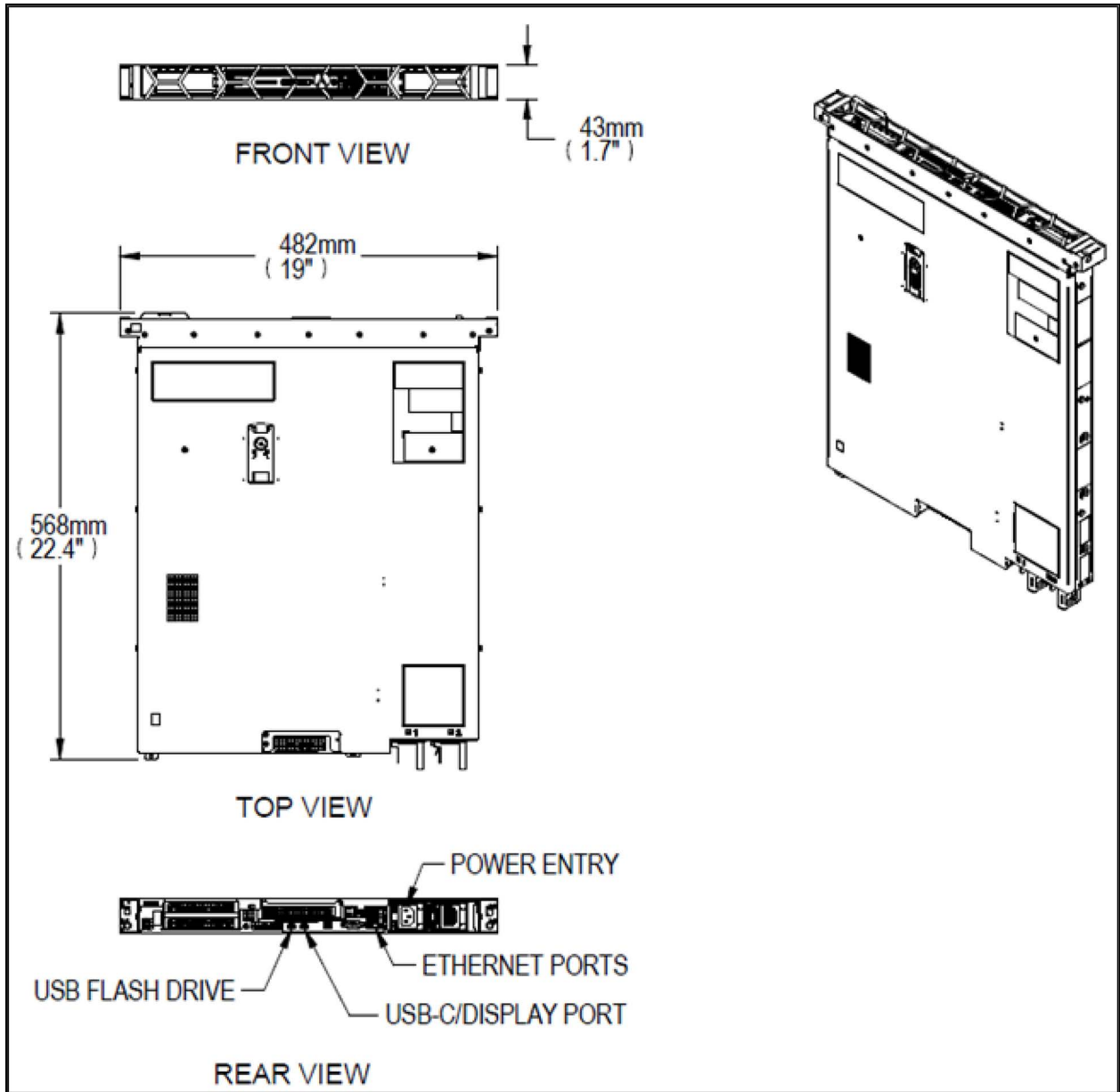

## 4.2.1 Wall Mount Installation

This section is used to help with installation of the Vertiv™ Liebert® iCOM™-S 1U Rail attachment.

Figure 4.4 Wall Mount Installation

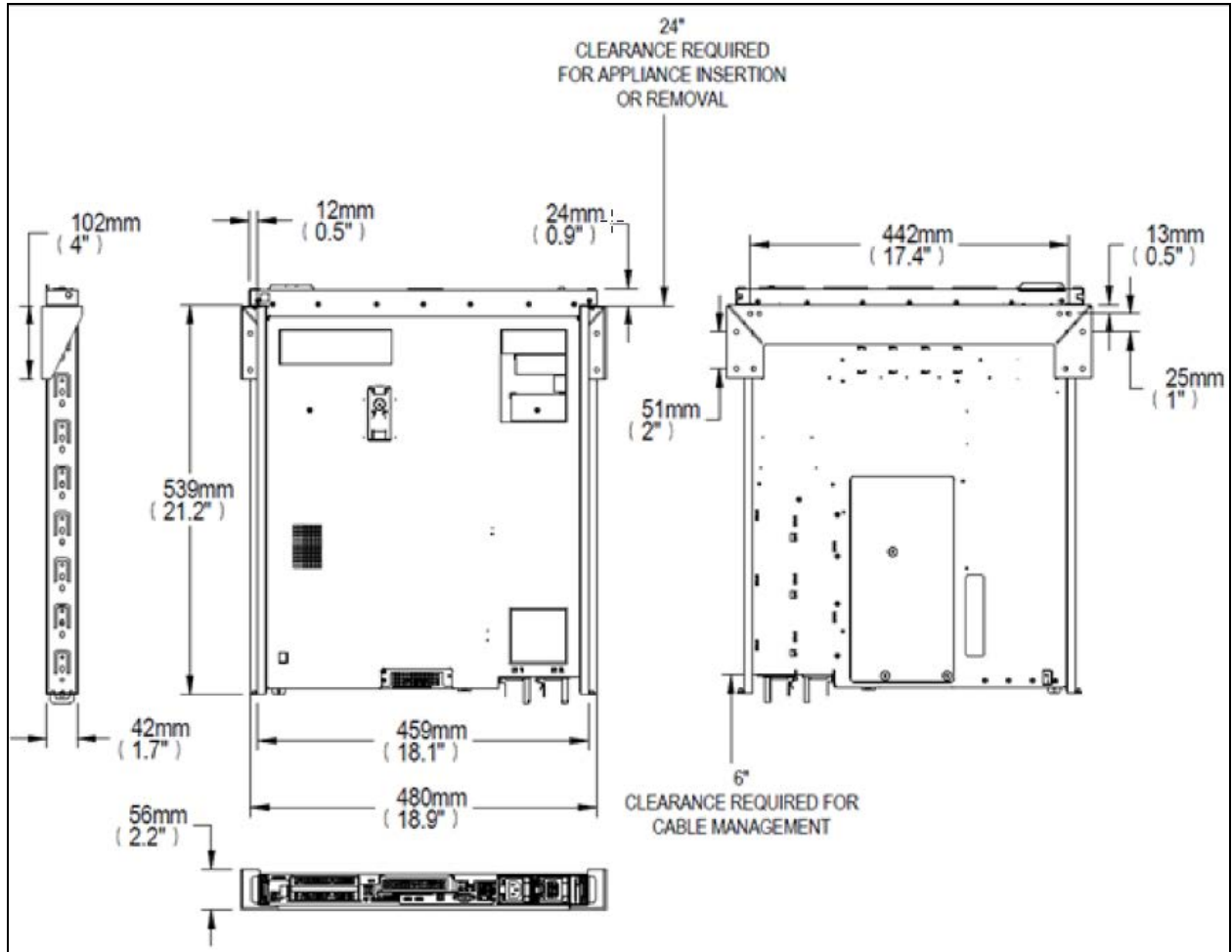

## 4.2.2 Rack Mount Installation

This section is used to help with installation of the Vertiv™ Liebert® iCOM™-S 1U Rail attachment.

Figure 4.5 Rack Mount Installation

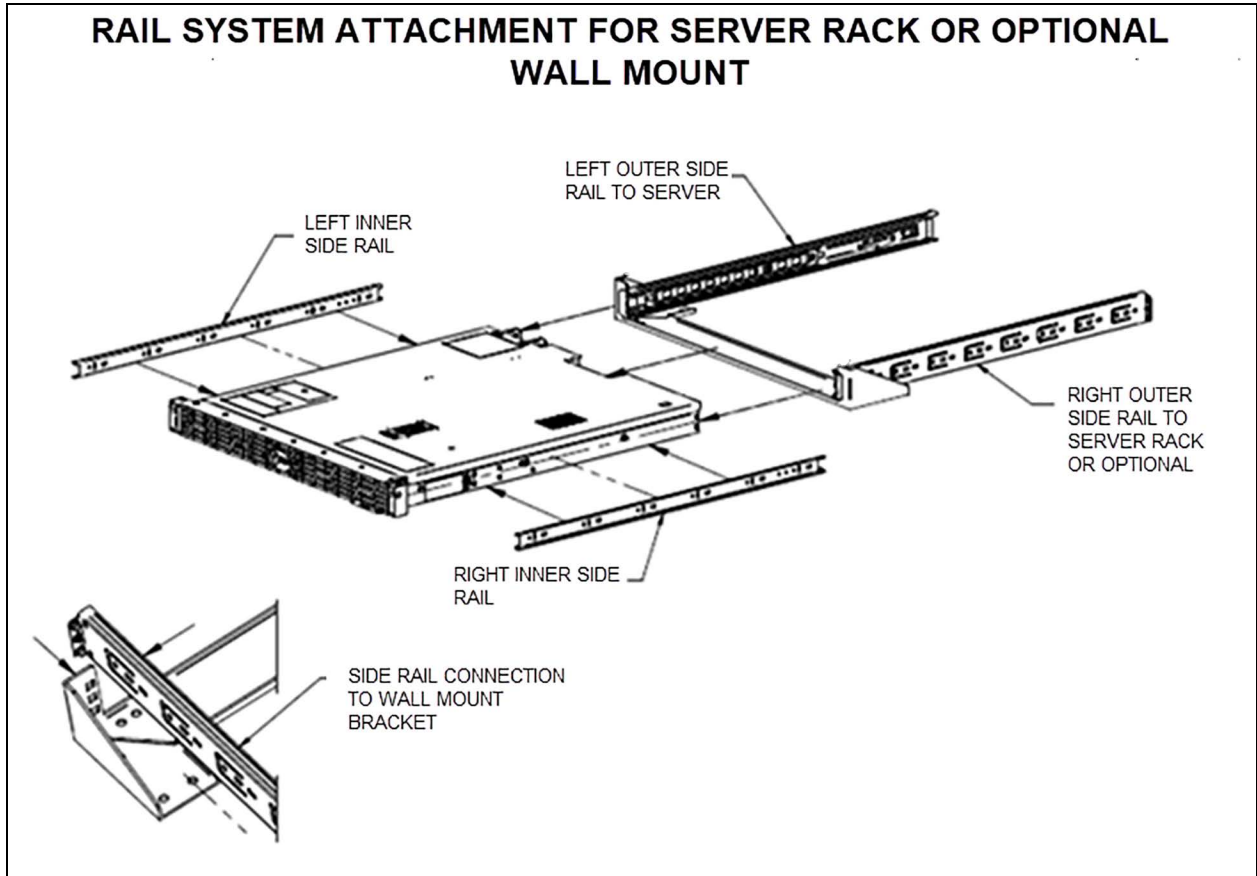

## 4.2.3 1U Power Up and Initial Connection

The USB-C connection on the rear is the only port that supports display. We recommend the use of a USB-C hub for additional connections (port for display, port for keyboard and mouse, port for removable storage).

The initial password matches the service tag number (lowercase) that is on the pullout service tag on the right lower front of the appliance.

## 4.3 Vertiv™ WSN Equipment

See DPN005190 in [Submittal Drawings](#) on page 139 .



## 4.4 (PA) Thermal Unit Configuration for Control

### 4.4.1 (PA) Control Sensor Configurations

The Vertiv™ Liebert® iCOM™-S panel used along with the unit-level Liebert® iCOM™-S controller allows for the use of Teamwork Mode 3 – Optimized Aisle operation. TW Mode 3 – Optimized Aisle is designed to operate Temperature Control (cooling capacity) and Fan Speed Control operation in a decoupled fashion, meaning the local unit-level controller must have separate sensors assigned to Temperature Control and Fan Speed Control Modes. Having separate sensors assigned to each control mode allows each mode of control to have separate tunable PI loops. The following unit level sensor configurations are supported in TW Mode 3:

**NOTE: In order to utilize Teamwork Mode 3, you must select one of the following sensor configurations.**

#### Mode D

- Temperature Control Sensor = Supply Sensor
- Fan Speed Control Sensor = Remote Sensor

#### Mode E

- Temperature Control Sensor = Supply Sensor
- Fan Speed Control Sensor = Return Sensor

The Temperature Control and Fan Speed Control sensor assignments can be made at the unit-level iCOM display via the **Service Menu > Setpoints submenu**. Please reference Temperature Control and Fan Speed Control, as shown in **Figure 4.6** on the next page and **Figure 4.7** on the next page .

Figure 4.6 Service Menu > Setpoints > Temperature Control

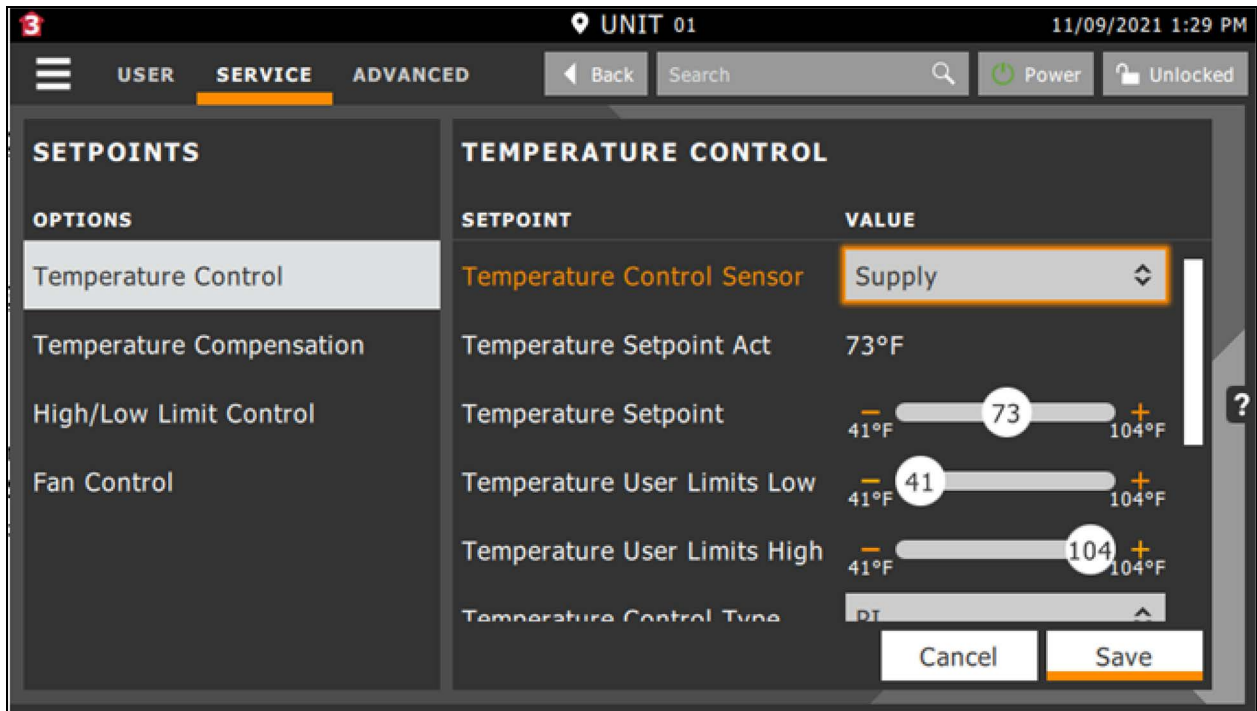
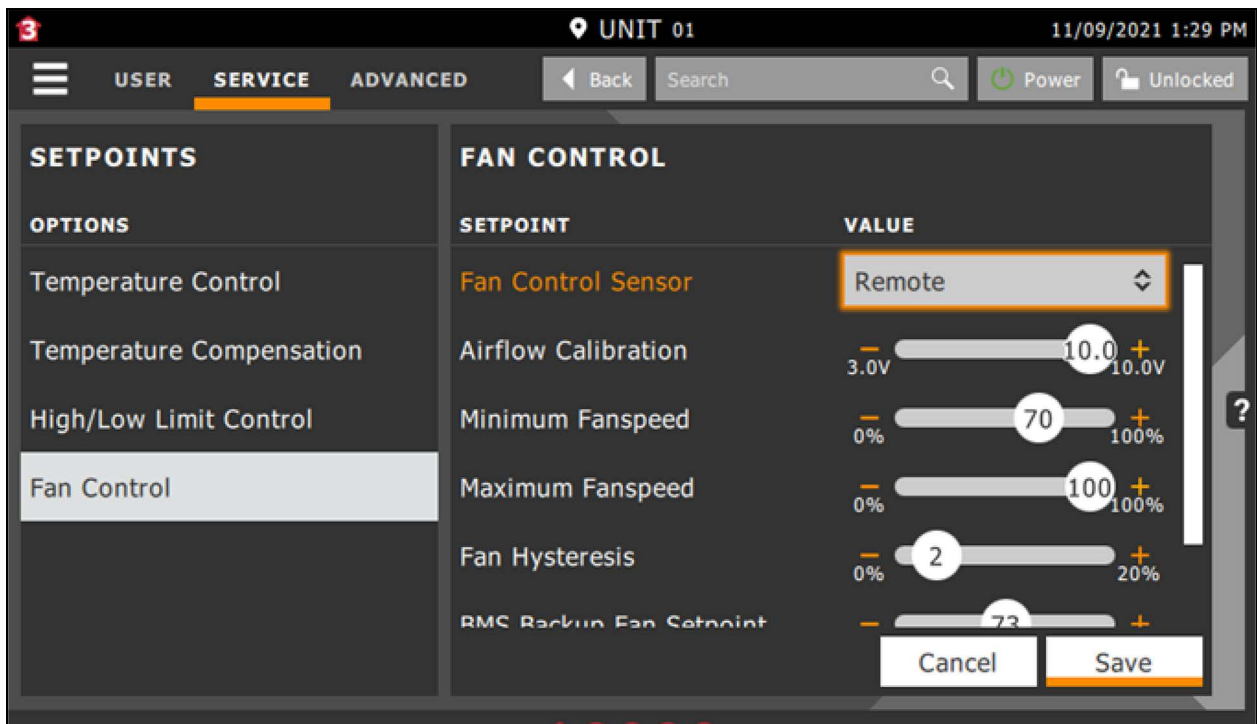

Figure 4.7 Service Menu > Setpoints > Fan Control



## 4.4.2 (PA) Configuring Team Work Mode 3

Once the Vertiv™ Liebert® iCOM™ control sensors have been properly assigned, you are now ready to enable Teamwork Mode 3 – Optimized Aisle. Teamwork setup is accomplished via the **iCOM display Service Menu > BMS & Teamwork > Teamwork/Standby submenu**.

**S802.1 Number of Connected Units** – Defines the total number of thermal units assigned to a given network group.

- Default = 1
- Adjustable range = 1 - 32

**S803.1 Teamwork Mode** – Defines which teamwork mode the end-user would like the network group of units to operate in.

- Default = 0 – No
- Adjustable range = 0 – No, 1 – Parallel, 2 – Independent, 3 – Optimized Aisle

**S804.1 Based On** – Defines the shared sensor aggregation method for a given network group of units configured for Teamwork Mode.

- Default = Maximum
- Adjustable range = Average, Maximum

**S806.1 Virtual Master** – When enabled, allows the Master level controller to rotate to the next available unit-to-unit (U2U) address should the Master unit go offline or no longer be visible on the network.

- Default = Enabled
- Adjustable range = Enabled, Disabled

Figure 4.8 Service Menu > BMS & Teamwork/Standby Teamwork Mode

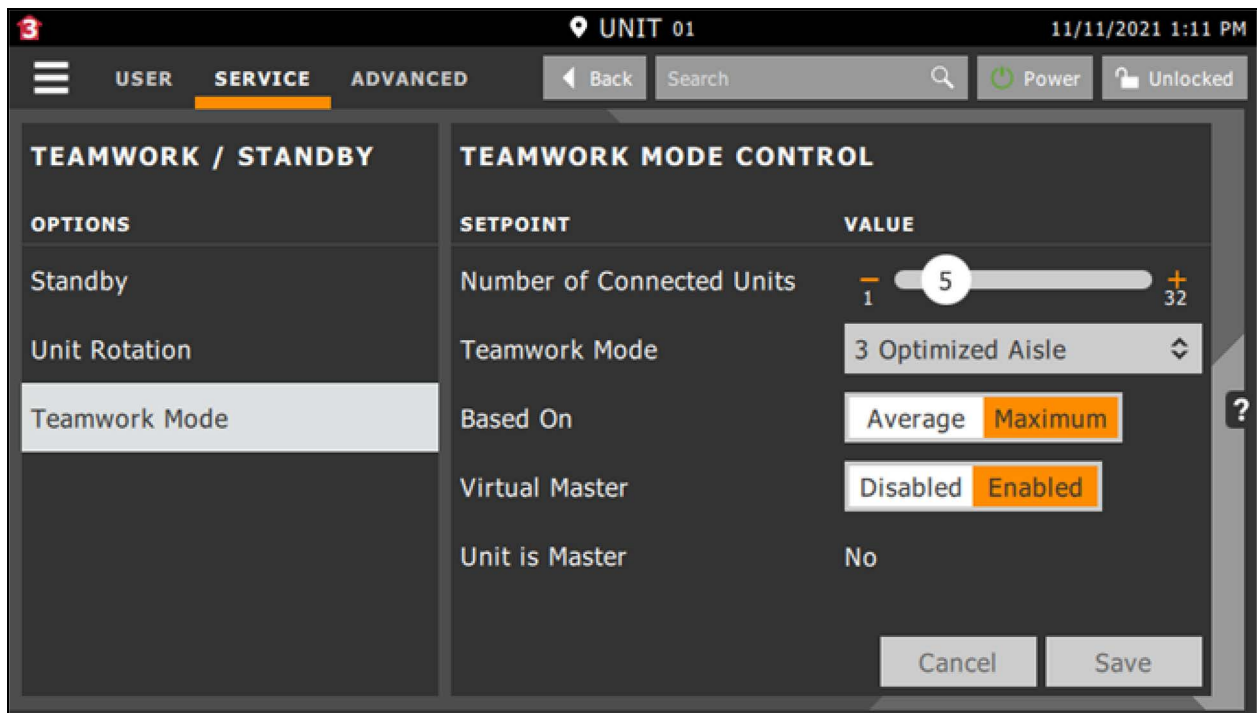

### 4.4.3 (PA) Auxiliary Air Temperature (AAT) Wireless Sensor Enablement

The Vertiv™ Liebert® iCOM™-S shall support the ability to integrate wireless temperature/humidity sensors (AAT) for monitoring and/or control and use them along with the hard wired sensors that are directly wired to each unit level controller.

In order to utilize the wireless sensor aspect of the Liebert® iCOM™-S, the auxiliary sensor input feature must first be enabled at the local iCOM™ unit level controller. These changes can be made via the **Service Menu > Auxiliary Device Setup > Sensors > Wireless Sensors** submenu.

#### Proxy Setup

**SB15.1 Enable Wireless Sensors** – Allows the end user to enable/disable the wireless sensor aspect of Liebert® iCOM™-S

- Default = disabled
- Adjustable range = enabled, disabled

**SB22.1 AAT Fallback Timer** – Defines the time that must surpass after the AAT Sensor communication with the unit level controller has been lost.

- Default = 60 sec
- Adjustable range = 0 – 999 sec

Figure 4.9 Service Menu > Auxiliary Device Setup > Sensors > Wireless Remote Sensors > Proxy Setup

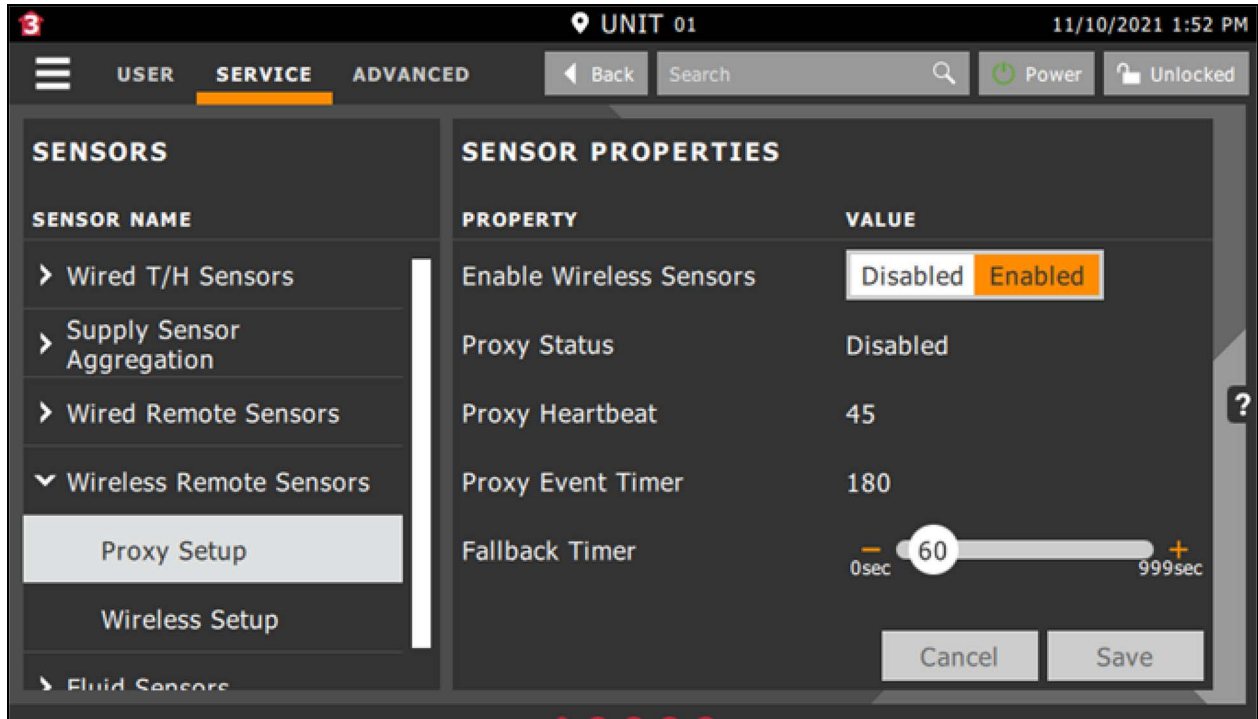

### 4.4.4 (PA) AAT Fallback Timer Operation

In the event the Auxiliary Air Temperature (AAT) or wireless sensors fail or are no longer communicating with the Vertiv™ Liebert® iCOM™-S, the unit level iCOM™ controller shall automatically take corrective action in order to resume normal operation. Corrective action entails automatically defaulting to a redundant sensor with zero human interaction.

The following information indicates how Liebert® iCOM™ shall operate in the event the wireless sensors are no longer communicating with the iCOM™-S panel or have failed. The redundant operation shall be based on how the Temperature Control and Fan Speed Control sensors are assigned (see Mode D and Mode E sensor configurations below).

#### Mode D - Control Sensor Assignments

- Temperature Control Sensor = Supply Sensor
- Fan Speed Control Sensor = Remote Sensor
  - If all the wireless sensors fail and there are no unit level, hard wired remote sensors being utilized, Temperature Control shall remain assigned to the Supply sensor and Fan Speed Control shall change to Supply control mode (i.e. supply sensor).

#### Mode E – Control Sensor Assignments

- Temperature Control Sensor = Supply Sensor
- Fan Speed Control Sensor = Return Sensor
  - If all the wireless sensors fail and there are no unit level, hard wired remote sensors being utilized, Temperature Control and Fan Speed Control shall resume normal operation based on the currently assigned sensors.

### 4.4.5 (PA) Configuration Wireless AAT for Teamwork Mode

**NOTE:** For a single unit to utilize the AAT for control, Teamwork must be enabled, meaning that the control is based upon this unit's measured temperature as well as the AAT value. The AAT value shall not be used for control units not configured for Teamwork Mode.

**SB20.1 Wireless Weighting in TW AVG** - The AAT value shall be capable of being aggregated with the Teamwork Master controller's temperature value and temperature values received from the remaining units within the same group.

- Default = 0%
- Adjustable range = 0 – 100%

**SB21.1 Wireless Use in TW MAX** - The AAT value can be made available to two aggregate methods employed in Teamwork for calculating a control temperature. The two aggregation methods are MAXIMUM and AVERAGE.

- Default = Exclude
- Adjustable range = Include, Exclude

**SB25.1 AAT Manual Override** - The AAT value can be manually overridden to provide a simulated AAT value.

- Default = Disabled
- Adjustable range = Enabled, Disabled

**SB26.1 AAT Manual Value** – Simulated AAT manual override temperature value configured by end user

- Default = 73 °F / 23.0 °C
- Adjustable range = 32 - 113 °F / 0.0 - 45.0 °C

**SB26.2 AAT Manual Timeout** – Timeout value which determines when the AAT Manual Override mode is no longer active, configured by the end user.

- Default = 30 min
- Adjustable range = 5 – 180 min

Figure 4.10 Service Menu &gt; Auxiliary Device Setup &gt; Sensors &gt; Wireless Remote Sensors &gt; Wireless Setup

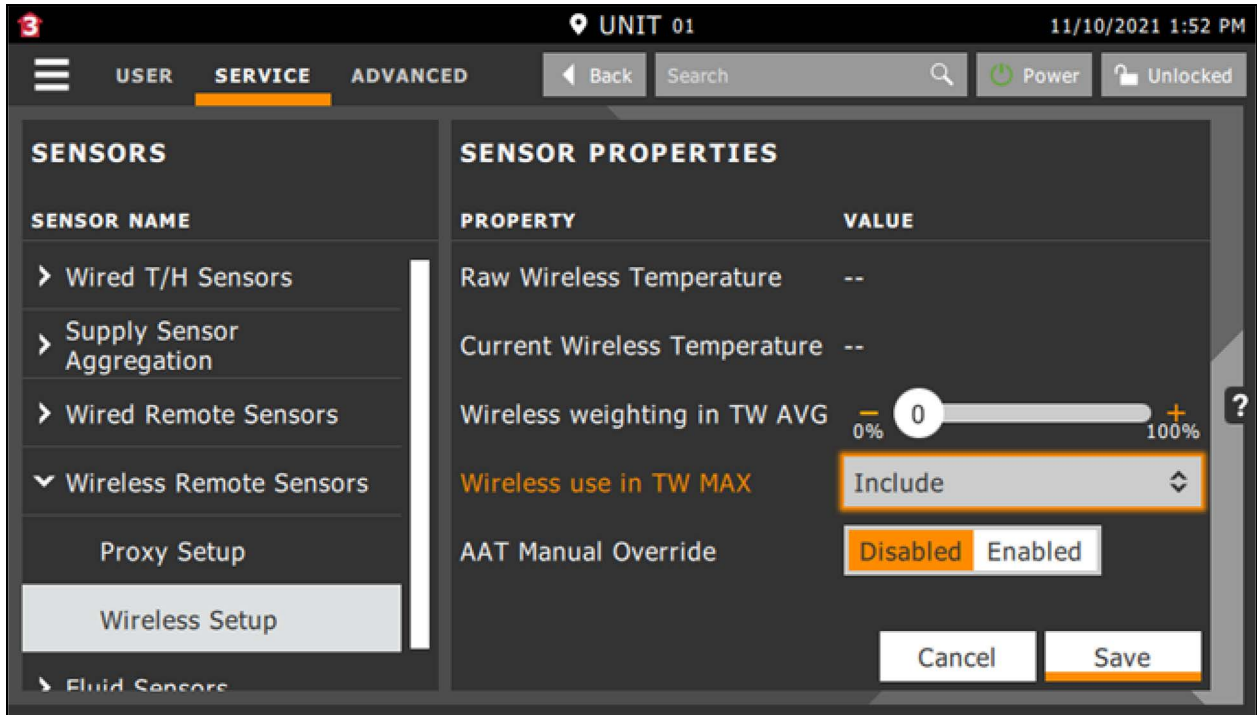

#### 4.4.6 (PA) Vertiv™ Liebert® iCOM™ Unit Level Operation — Redundancy

In the event of an interruption in the standard airflow and/or cooling capacity controlling aspect for a given Liebert unit (due to alarm, failure, etc.), the Liebert® iCOM™ controller shall provide adjustable/programmable protective measures which may be configured by the end-user. iCOM™ supports both Loss of Airflow and Loss of Cooling operation redundancy modes, which may be configured based on end-user requirements. Liebert® iCOM™ shall automatically default to the redundant control mode during a control sensor failure situation with zero human interaction. The following Liebert® iCOM™ parameters can be adjusted via the **iCOM Display Advanced Menu > Factory Settings submenu**.

**A104.2 Loss of Airflow – Unit Operation** – Defines the unit operation Liebert® iCOM™ shall default to in the event of a Loss of Airflow alarm event.

- Default = Shutdown
- Adjustable range = Disable, Shutdown

**A104.3 Loss of Airflow – Fan Operation** – Defines the unit fan operation Liebert® iCOM™ shall default to in the event of a 'Loss of Airflow' alarm event.

- Default = Fan On
- Adjustable range = Fan ON, Fan OFF

**A105.1 Loss of Cooling – Fan Operation** – Defines the unit fan operation Liebert® iCOM™ shall default to in the event of a loss of cooling event (due to alarm, failure, etc.)

- Default = Normal
- Adjustable range = Normal, Minimum, Standby

Figure 4.11 Advanced Menu &gt; Factory Settings

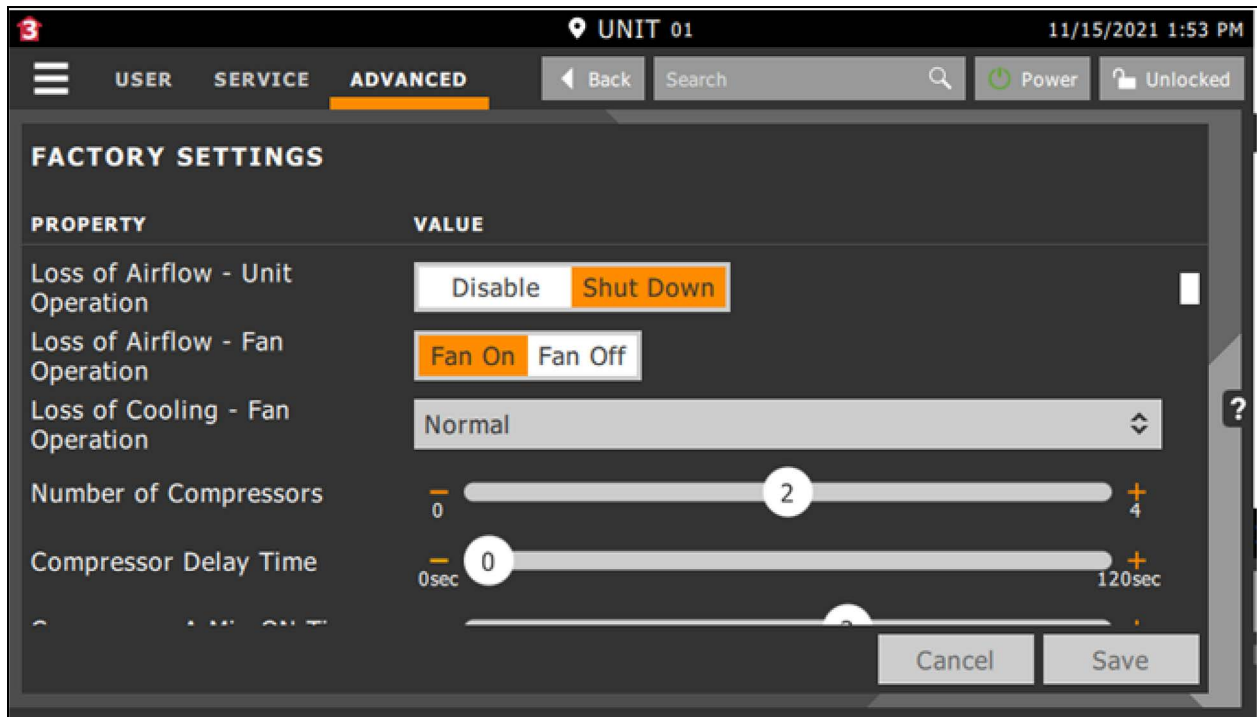

Vertiv™ Liebert® iCOM™ also provides the capability for the end user to determine the overall unit operation during a complete control sensor failure event. Liebert® iCOM™ shall automatically default to the redundant control mode during a control sensor failure situation with zero human interaction. The following Liebert® iCOM™ parameters may be adjusted at the unit level **iCOM display via the Service Menu > Options Setup > Misc. Settings** submenu.

**S22A.1 Operation at Temperature Control Sensor Failure** – Defines the general unit operation Liebert® iCOM™ shall default to in the event of a temperature control sensor failure event. Options include continue unit cooling -or- shutdown the unit completely.

- Default = Cooling
- Adjustable range = Cooling, Shutdown.

**S22A.2 Temperature Control Sensor Failure – Cooling Mode** – Defines the unit cooling capacity operation Liebert® iCOM™ shall default to in the event of a temperature control sensor failure event. Selectable options include full cooling -or- hold last known call for cooling based on current PI settings.

- Default = Full
- Adjustable range = Full, Hold

Figure 4.12 Service Menu &gt; Options Setup &gt; Misc. Settings

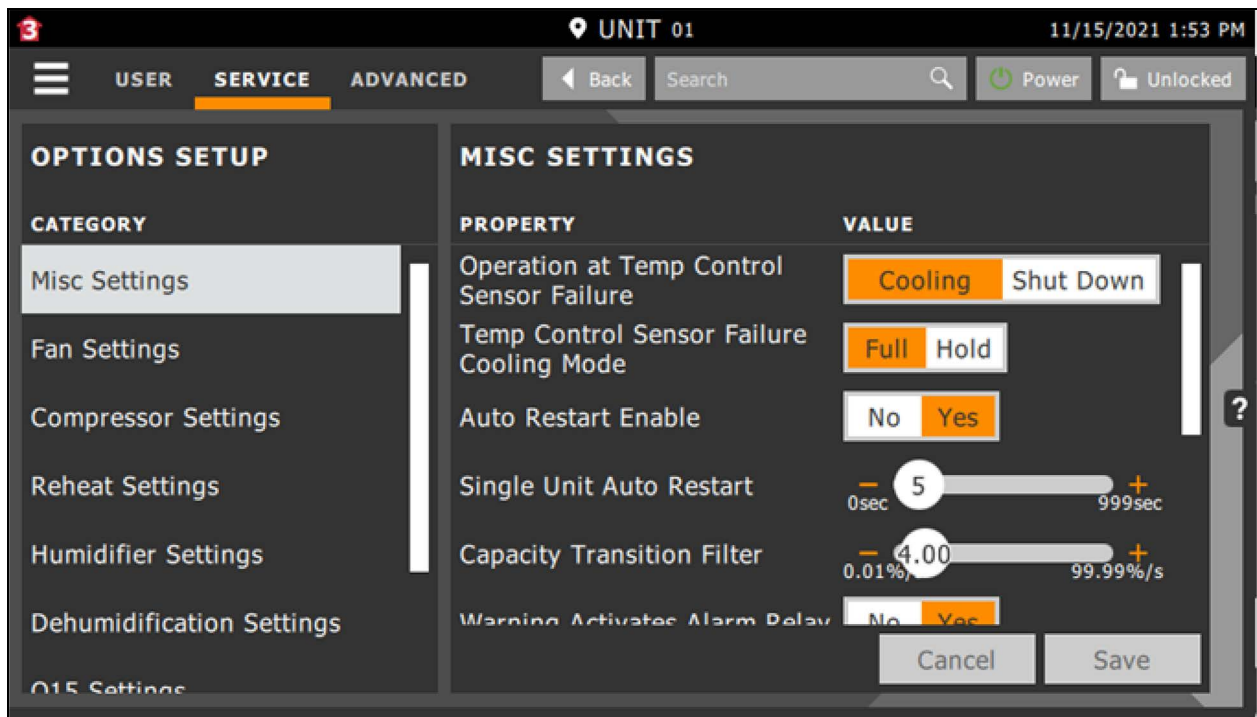

## 4.5 (A9H) Thermal Unit Configuration for Control

### 4.5.1 (A9H) Control Sensor Configuration

The Vertiv™ Liebert® iCOM™-S panel used along with the unit level Liebert® iCOM™-S controller allows for the use of Cold Aisle operation. Cold Aisle is designed to operate Temperature Control (cooling capacity) and Fan Speed Control operation in a decoupled fashion, meaning the local unit-level controller must have separate sensors assigned to Temperature Control and Fan Speed Control Modes. Having separate sensors assigned to each control mode allows each mode of control to have separate tunable PI loops. The following unit level sensor configurations are supported in Cold Aisle Mode:

**NOTE:** There are two different A9H versions available: the standard A9H, and the version, U2U compatible to PA - which has the suffix MT (which stands for Modbus Teamwork).

In order to activate Cold Aisle, you must select the following settings:

- **A9H:** Set S803, Teamwork Mode, to 1, and set SB02, Aisle Control Enabled to Yes
- **A9H\_MT:** Set S803, Teamwork Mode, to 3 (sets SB02, Aisle Control Enabled automatically to Yes)

This setup automatically sets

- **S124 Temperature Control Sensor** = Supply Sensor
- **SB11 Fan Speed Control Sensor** = Remote Sensor, which afterwards can be changed to Return Sensor.

The settings can be made at the Liebert® iCOM™ display via the **Service Menu > S800 System / Network Setup, and Service Menu > SB00 Cold Aisle Settings submenu**. Please reference S803 and SB02 (as shown on the next page).



**S802 Number of Connected Units** – Defines the total number of thermal units assigned to a given network group.

- Default = 1
- Adjustable range = 1 - 32

**S803 Teamwork Mode** – defines which teamwork mode the end user would like the network group of units to operate in.

- Default = 0 - No
- A9H: adjustable range = 0 - No, 1 - Parallel, 2 - Independent, 3 - Economy Teamwork (not used)
- A9H\_MT: adjustable range = 0 - No, 1 - Parallel, 2 - Independent, 3 - Cold Aisle

**S804** is not used, and shall remain at No.

**S805** is not used and cannot be selected.

**Figure 4.13 Sensor Control Configuration**

SYSTEM / NETWORK SETUP 1/2			SYSTEM	AISLE SETUP 1/6			SYSTEM
S801	PASSWORD (Actual Level 7)		????	S801	PASSWORD (Actual Level 7)		????
S802	Number of Connected Units		4	S802	Aisle Control Enabled		Yes
S803	Teamwork Mode		3	S803	Temperature Setpoint		36.0°C
S804	Sequencer Mode		No	S804	Temperature Proportional Band		4.0K
S805	SCR Parallel Comp Management			S805	Temperature Integration Time		0min
S806				S806	Temperature Controlled by		Highest
S807				S807	Humidity Setpoint		50%
S808				S808	Humidity Proportional Band		10%
S809	Configuration Safe	OK	No	S809	Humidity Integration Time		Nomin
S810	Network Safe	OK	No	S810	Humidity Controlled by		Highest
S811	SW Version	A9H 1.04.53R.MT		S811	Sensor Visualization (System)		Return

### 4.5.2 (A9H) Remote THB Enablement

A9H versions up to A9H1.04.052R need to have at a minimum one remote THB configured, whether or not an AAT is configured. A maximum of 3 THB's can be configured per unit.

A9H versions A9H1.04.053R or higher can operate Cold Aisle with remote THB's only, with AAT only or a combination of both.

The remote THB configuration is done in pages 4 and 5 of **Service Menu > SB00 Cold Aisle Settings**.

**Figure 4.14 Remote THB Configuration**

REMOTE TEMP.SENSOR 4/6			UNIT 03	REMOTE HUM.SENSOR 5/6			UNIT 03
S834	PASSWORD (Actual Level 7)		????	S845	PASSWORD (Actual Level 7)		????
S835	Remote THB 1 Enabled		Yes	S846	Remote THB 1 Enabled		Yes
S836	Remote THB 1		0.0K	S847	Remote THB 1		0.0%
S837	Calibrated Remote THB 1		24.8°C	S848	Calibrated Remote THB 1		24.6%
S838	Remote THB 2 Enabled		No	S849	Remote THB 2 Enabled		No
S839	Remote THB 2		K	S850	Remote THB 2		%
S840	Calibrated Remote THB 2		°C	S851	Calibrated Remote THB 2		%
S841	Remote THB 3 Enabled		No	S852	Remote THB 3 Enabled		No
S842	Remote THB 3		K	S853	Remote THB 3		%
S843	Calibrated Remote THB 3		°C	S854	Calibrated Remote THB 3		%
S844	Value Sent to Master		°C 24.8°C	S855	Value Sent to Master		3.3 24.6%

### 4.5.3 (A9H) Auxiliary Air Temperature (AAT) Wireless Sensor Input Enablement

The Vertiv™ Liebert® iCOM™-S shall support the ability to integrate wireless temperature/humidity sensors (AAT) in for monitoring and/or control and use them along with the hard wired sensors that are directly wired to each unit level controller.

In order to utilize the wireless sensor aspect of the Liebert® iCOM™-S, the auxiliary sensor input feature must first be enabled at the local iCOM unit level controller. These changes can be made via the **Service Menu > Auxiliary Air Temperature Sensor** submenu.

#### Proxy Setup

**SD02 Auxiliary Air Temperature** – Allows the end user to enable/disable the wireless sensor aspect of Liebert® iCOM™-S.

- Default = Disabled
- Adjustable range = Enabled, disabled

**SD09 AAT Fallback Timer** – Defines the time that must surpass after the AAT Sensor communication with the unit-level controller has been lost.

- Default = 60 sec
- Adjustable range = 0 – 999 sec

### 4.5.4 (AH9) Configuration Wireless (AAT) for Teamwork Mode

**NOTE:** For a single unit to utilize the AAT for control, Teamwork must be enabled, meaning that the control is based upon this unit's measured temperature as well as the AAT value. The AAT value shall not be used for control units not configured for Teamwork Mode.

**SD07 Auxiliary Weighting in TW AVG** - The AAT value shall be capable of being aggregated with the Teamwork Master controller's temperature value and temperature values received from the remaining units within the same group.

- Default = 0%
- Adjustable range = 0 – 100%

**SD08 Auxiliary Use in TW MAX** - The AAT value can be made available to two aggregate methods employed in Teamwork for calculating a control temperature. The two aggregation methods are MAXIMUM and AVERAGE.

- Default = Exclude
- Adjustable range = Include, Exclude

**SD12 AAT Manual Override** - The AAT value can be manually overridden to provide a simulated AAT value.

- Default = Disabled
- Adjustable range = Enabled, Disabled

**SD13 AAT Manual Value** – Simulated AAT manual override temperature value configured by end user

- Default = 73 °F / 23.0 °C
- Adjustable range = 32 - 113 °F/0.0 - 45.0 °C

**SD09 AAT Fallback Timer Operation** – In the event the Auxiliary Air Temperature (AAT) or wireless sensors fail or are no longer communicating with the Vertiv™ Liebert® iCOM™-S, the unit level iCOM controller shall automatically take corrective action in order to resume normal operation. Corrective action entails automatically defaulting to a redundant sensor with zero human interaction.

The following information indicates how Liebert® iCOM™ shall operate in the event the wireless sensors are no longer communicating with the Liebert® iCOM™-S panel or have failed.

Figure 4.15 Wireless Sensors Not Communicating with Vertiv™ Liebert® iCOM™-S

AUXILIARY AIR TEMPERATURE SETUP 1/2		<UNIT 01>	
S001	PASSWORD (Actual Level 7)	????	
S002	Auxiliary Air Temperature	Enabled	
S003	Auxiliary Proxy Status	Initializing	
S004	AP Heartbeat / Event Timer	15/ 360s	
S005	Raw Auxiliary Air Temperature	°C	
S006	Act Auxiliary Air Temperature	23.6°C	
S007	Auxiliary Weighting in TW AVG	80%	
S008	Auxiliary Use in TW MAX	Only	
S009	AAT Fallback Timer	60s	
S010	Filter AAT Temperature	10.00K/s	
S011	Filter TW Aggregate Ctrl Temp	10.00K/s	
S012	AAT Manual Override	Enabled	
S013	AAT Manual Value	23.6°C	

#### 4.5.5 (A9H) Vertiv™ Liebert® iCOM™ Unit Level Operation—Redundancy

In the event of an interruption in the standard airflow and/or cooling capacity controlling aspect for a given Liebert unit (due to alarm, failure, etc.), the Liebert® iCOM™ controller shall provide adjustable/programmable protective measures which may be configured by the end user. Liebert® iCOM™ supports both Loss of Airflow and Loss of Cooling operation redundancy modes, which may be configured based on end-user requirements. Liebert® iCOM™ shall automatically default to the redundant control mode during a control sensor failure situation with zero human interaction. The following Liebert® iCOM™ parameters can be adjusted via the iCOM™ display **Advanced Menu > Factory Settings** submenu.

**A104 Loss of Airflow** (left hand value) – Defines the unit fan operation Liebert® iCOM™ shall default to in the event of a Loss of Airflow alarm event.

- Default = Fan Off
- Adjustable range = Fan On, Fan Off

**A104 Loss of Airflow** (right hand value) – defines the unit operation Liebert® iCOM™ shall default to in the event of a ‘Loss of Airflow’ alarm event.

- Default = Shutdown
- Adjustable range = Disable, Shutdown

This page intentionally left blank

## 5 Software Setup

The Vertiv™ Liebert® iCOM™-S software starts up automatically when the appliance is powered up.

The power up button on the 1U workstation is on the front of the appliance behind the bezel just to the left of the rightmost SATA drive bay.

The power up button on the panel appliance is found on the right hand side of the PC (circular button) which can be seen after opening the panel appliance touchscreen door.

To power up the Liebert® iCOM™-S Touchscreen Panel Appliance, see [Vertiv™ Liebert® iCOM™-S Touch Screen Panel Appliance](#) on page 25

To power up the Liebert® iCOM™-S 1U Workstation Appliance, see [Vertiv™ Liebert® iCOM™-S 1U Workstation Appliance](#) on page 29

In both cases, powering up the appliance will start the Microsoft Windows operating system, after which the Liebert® iCOM™-S services will start.

**NOTE: There are currently 23 Liebert® iCOM™-S services that each perform separate tasks for the iCOM™-S system. These can be seen in the Windows Services app. They are controlled by the Service Manager service, which is the only one set to automatically start up. Once it starts, then it starts up the other services in a specific order. If you need to start or stop all the services manually, you only start or stop the Service Manager and let it do the rest.**

Figure 5.1 Windows Services Manager

Name	Description	Status	Startup Type	Log On As
Vertiv iCOM-S Authentication Service	Manages all...	Running	Manual	.\\icomcs
Vertiv iCOM-S BMS Service	Handles pro...	Running	Manual	.\\icomcs
Vertiv iCOM-S Calculations Processor Service	Handles all c...	Running	Manual	.\\icomcs
Vertiv iCOM-S Cloud Connector Service	Handles all i...	Running	Manual	.\\icomcs
Vertiv iCOM-S Configuration Service	Manages all...	Running	Manual	.\\icomcs
Vertiv iCOM-S Data Service	Manages da...	Running	Manual	.\\icomcs
Vertiv iCOM-S Diagnostic Service	Gathers dia...	Running	Automatic	.\\icomcs
Vertiv iCOM-S Event Service	Manages ev...	Running	Manual	.\\icomcs
Vertiv iCOM-S Gateway Management Service	Manages all...	Running	Manual	.\\icomcs
Vertiv iCOM-S GBP Data Acquisition Service	Handles all ...	Running	Manual	.\\icomcs
Vertiv iCOM-S Hart Data Acquisition Service	Handles all ...	Running	Manual	.\\icomcs
Vertiv iCOM-S iCOM3 Data Acquisition Service	Handles all i...	Running	Manual	.\\icomcs
Vertiv iCOM-S ModBus Data Acquisition Service	Handles all ...		Disabled	.\\icomcs
Vertiv iCOM-S Notification Service	Handles not...	Running	Manual	.\\icomcs
Vertiv iCOM-S Operations Log Service	Handles Op...	Running	Manual	.\\icomcs
Vertiv iCOM-S Reporting Service	Handles pro...	Running	Manual	.\\icomcs
Vertiv iCOM-S Rules Processor Service	Provides Rul...	Running	Manual	.\\icomcs
Vertiv iCOM-S Scheduled Job Processor	Manages all...	Running	Manual	.\\icomcs
Vertiv iCOM-S Service Manager	Manages all...	Running	Automatic	.\\icomcs
Vertiv iCOM-S System Insights Service	Looks for Sy...	Running	Manual	.\\icomcs
Vertiv iCOM-S Telemetry Service	Handles all ...	Running	Manual	.\\icomcs
Vertiv iCOM-S Utility Service	Manages all...	Running	Manual	.\\icomcs
Vertiv iCOM-S Web Interface	Manages W...	Running	Manual	.\\icomcs
Vertiv iCOM-S Web Proxy Service	Apache/2.4.5...	Running	Manual	.\\icomcs
Vertiv iCOM-S WSN Data Acquisition Service	Handles all ...	Running	Manual	.\\icomcs

## 5.1 Viewing/Connecting Vertiv™ Liebert® iCOM™-S User Interface

### 5.1.1 Direct on Appliance

In this case, the desktop UI has been installed on the appliance along with all the rest of the Vertiv™ Liebert® iCOM™-S software. To start it, click the UI icon on the Windows desktop. The UI will appear and run in full screen mode, occupying the entire screen.



Alternatively, you can:

- Press the **Windows Start** button and scroll down to the Liebert® iCOM™-S folder where you will find the UI icon.
- Press the **Windows Start** button and start typing Liebert® iCOM™-S UI. Windows will find the icon for you and you can select it.

## Installing the Remote Desktop UI Application

To install the UI as a remote desktop application, run the Liebert® iCOM™-S Installer on the remote computer. This remote computer must be present on the Liebert® iCOM™-S appliance's northbound network so that it can communicate with the iCOM™-S services.

Follow this procedure:

1. Select the Custom Install option.

Figure 5.2 Install Remote Desktop UI Application

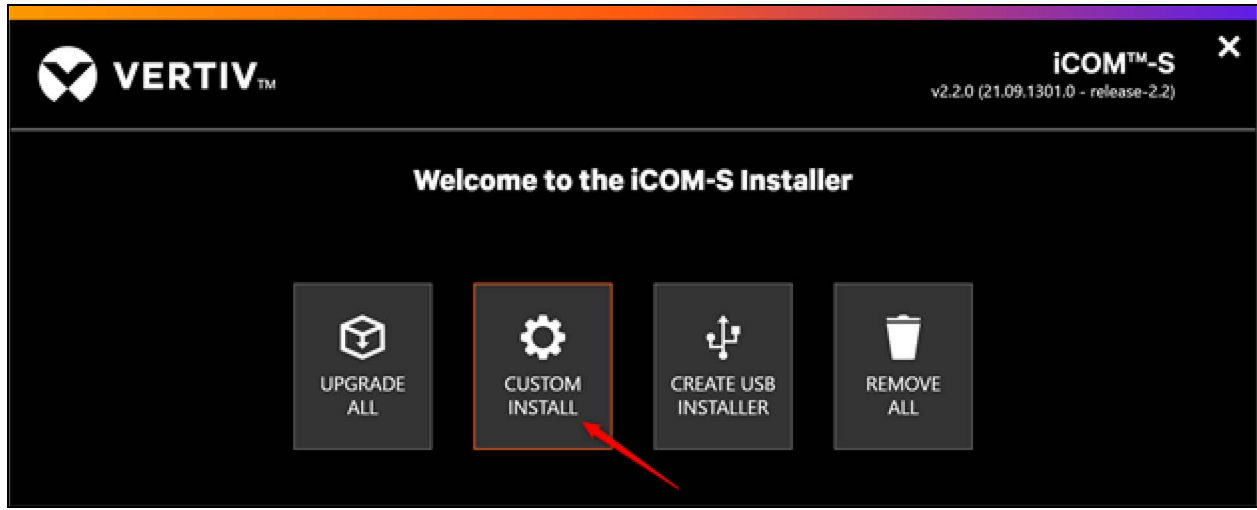

2. The Components to Install screen opens.
  - a. Select the **iCOM-S** component from the User Interfaces section. The Remote Client UI appears in the Advanced section to the left.
  - b. Click **Next**.

**NOTE:** If the Back End Services component is highlighted already, then Liebert® iCOM™-S is already installed on this computer and you are not really installing a remote UI. In that case, you are just adding the desktop UI to the installation.

**NOTE:** You can choose any or all of the User Interfaces components and as long as the Back End Services are not selected, you will have a remote UI Installation.

Figure 5.3 Components to Install Screen

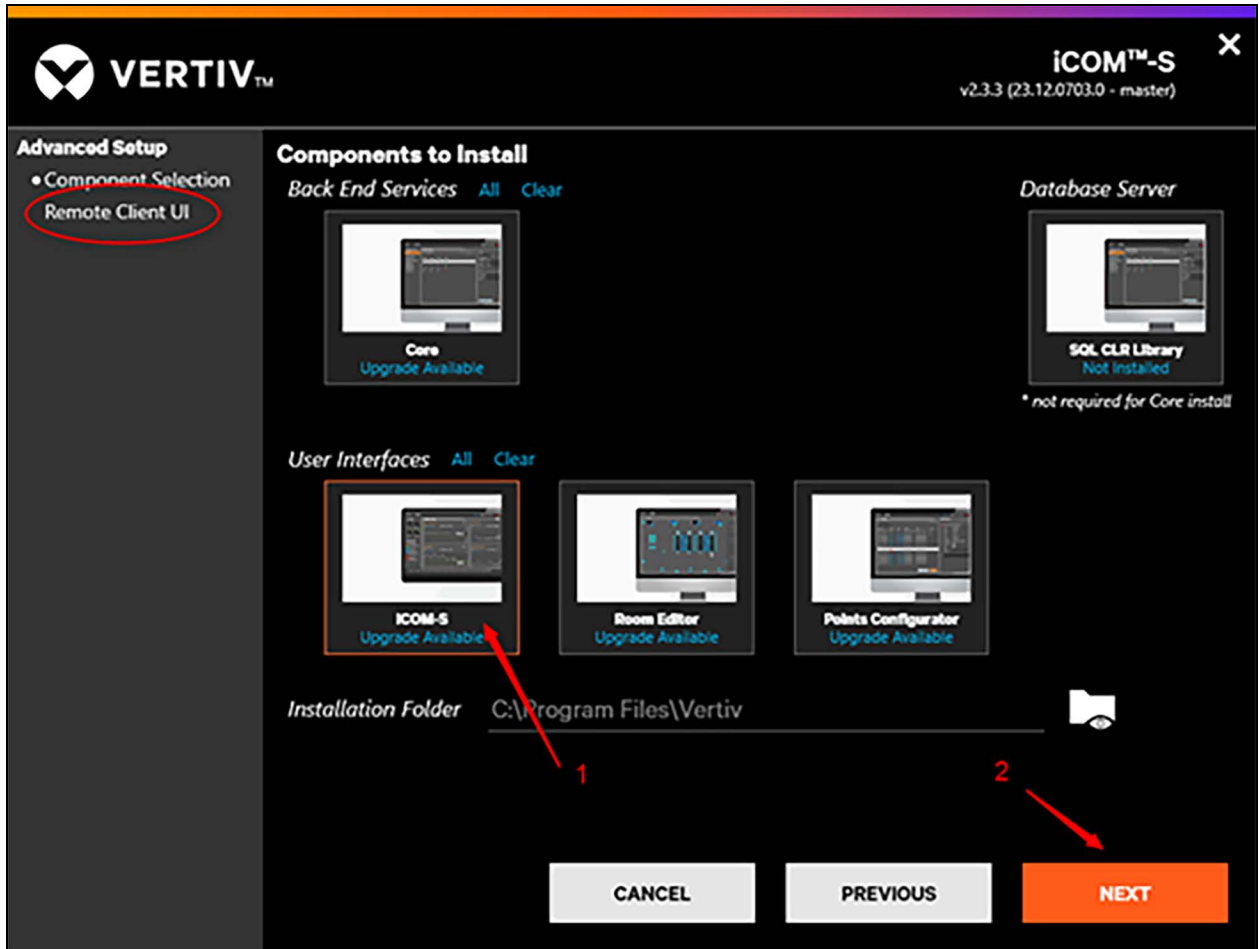

3. The Remote Client UI screen opens. Enter the IP address of the Liebert® iCOM™-S appliance. This is where the Liebert® iCOM™-S services are running which the UI communicates with. Click **Next** to start the installation.



Figure 5.4 Remote Client UI Screen

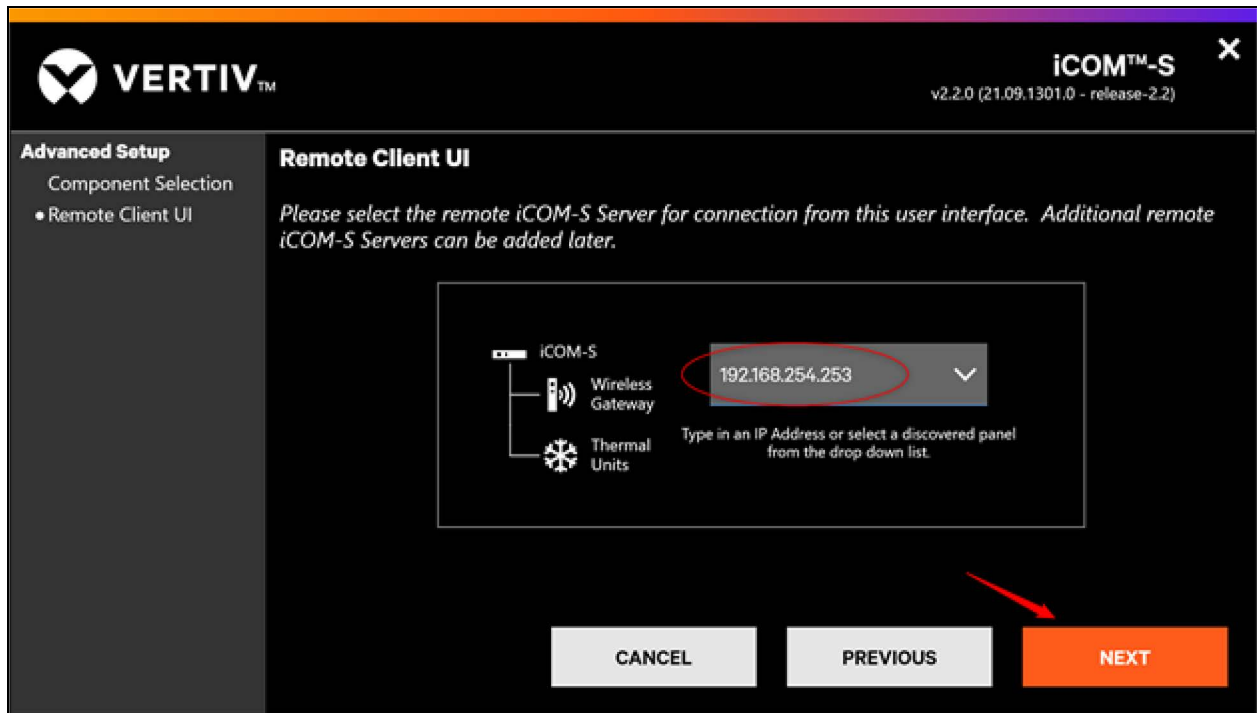

## 5.1.2 Remote Web Browser

In addition to the desktop UI, Vertiv™ Liebert® iCOM™-S contains a web-based UI. This is designed to look and feel very much like the desktop UI, which minimizes the learning curve.

**NOTE: Not all UI functionality is available through the Web UI when compared to the Desktop UI. For the full Liebert® iCOM™-S UI experience, the Desktop UI (either local or remote) is recommended.**

The web UI supports the Microsoft Edge or Google Chrome browsers.

To access the web UI, enter a URL of `https://<IP of iCOM-S Core Services>`. For example: `https://192.168.254.253`.

**NOTE: If you are running the web UI directly on the Liebert® iCOM™-S appliance, you can enter `https://localhost`.**

## 5.1.3 Remote Windows Desktop

There may be times when you want to access the desktop UI of multiple appliances. In this case, you can use the Microsoft Windows Remote Desktop software to establish a connection to the desired appliance, and then run the UI.

Please refer to online documentation provided by Microsoft for configuring the Remote Desktop access.

## 5.2 Applying Your License

After installing Vertiv™ Liebert® iCOM™-S on a new system you should start the iCOM™-S desktop UI. You might see a window informing you that the product is unlicensed and providing several courses of action.

Figure 5.5 License Management

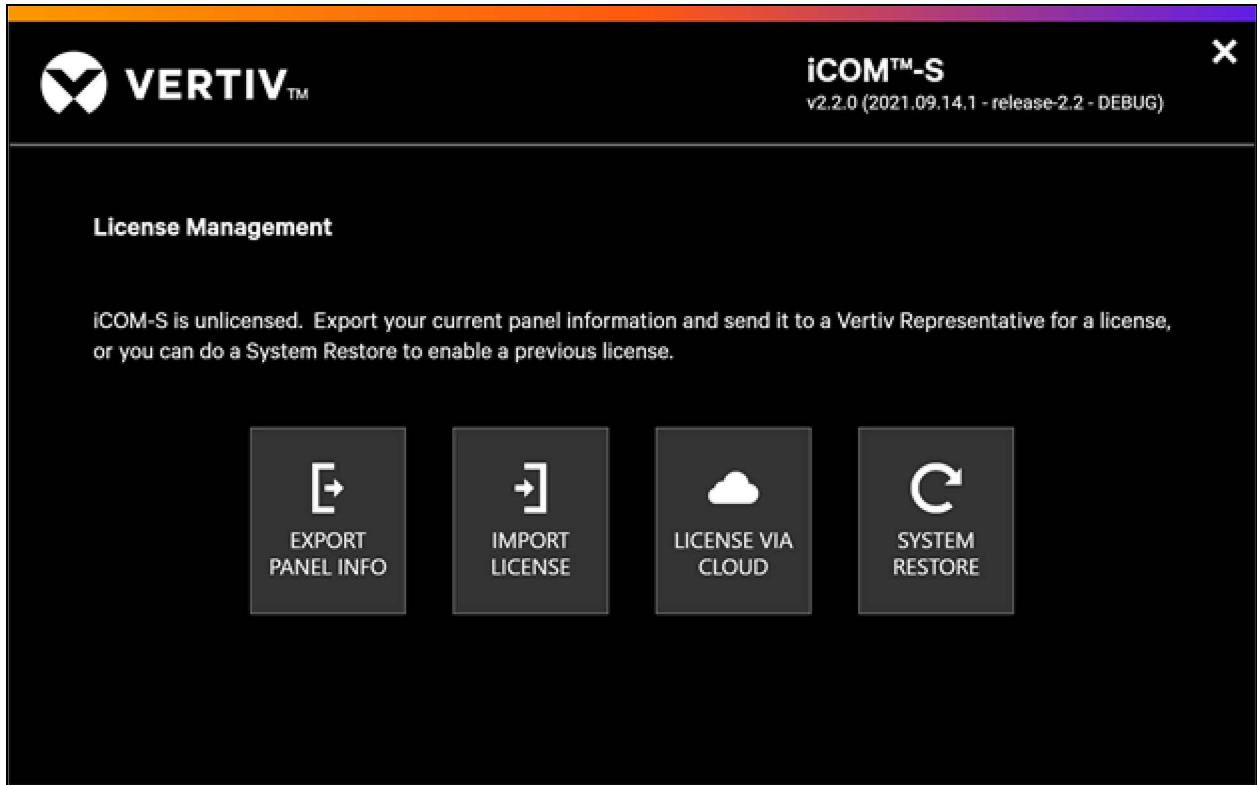

### 5.2.1 Export Panel Info

To access the Vertiv™ Liebert® iCOM™-S system, it must first be licensed. Licensing is accomplished by clicking the Export Panel Info button and saving the generated text file. This text file should be forwarded with the request for licensing along with:

Company name, site contact, contact phone, and contact email.

To reach Liebert® iCOM™-S Support for licensing contact [na.icomssupport@vertiv.com](mailto:na.icomssupport@vertiv.com).

### 5.2.2 Import Panel Info

Use this method to import an existing license for your panel, which you had received previously from Vertiv. Selecting **Import License** will bring up an Open File dialog, which will allow you to navigate to and select your license file. The license file enables the Vertiv™ Liebert® iCOM™-S features and options that you have purchased. When you select the license file, select **Open** to import it.

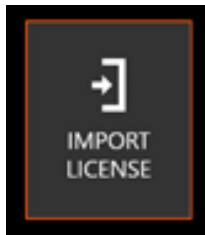

### 5.2.3 License via Cloud

Use this method to obtain your license from the Vertiv cloud. This license would have been generated for you by your Vertiv rep specifically for your Vertiv™ Liebert® iCOM™-S appliance. Pressing the button will start the process.

**NOTE: The Liebert® iCOM™-S will need to have internet connectivity (behind the customer firewall).**



### 5.2.4 System Restore

The system restore button allows users to restore their Vertiv™ Liebert® iCOM™-S system using a saved configuration or full system backup. The Liebert® iCOM™-S system will save a configuration file and create a full system backup every morning.

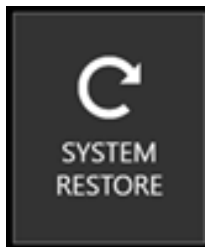

### 5.2.5 The Licensing Process

Once you have selected the Vertiv provided license, the licensing process begins. First, the UI will shut itself down, and an Import utility will start. This will go through several steps to apply the license to the Vertiv™ Liebert® iCOM™-S installation. This process will take several minutes to complete.

Figure 5.6 Licensing

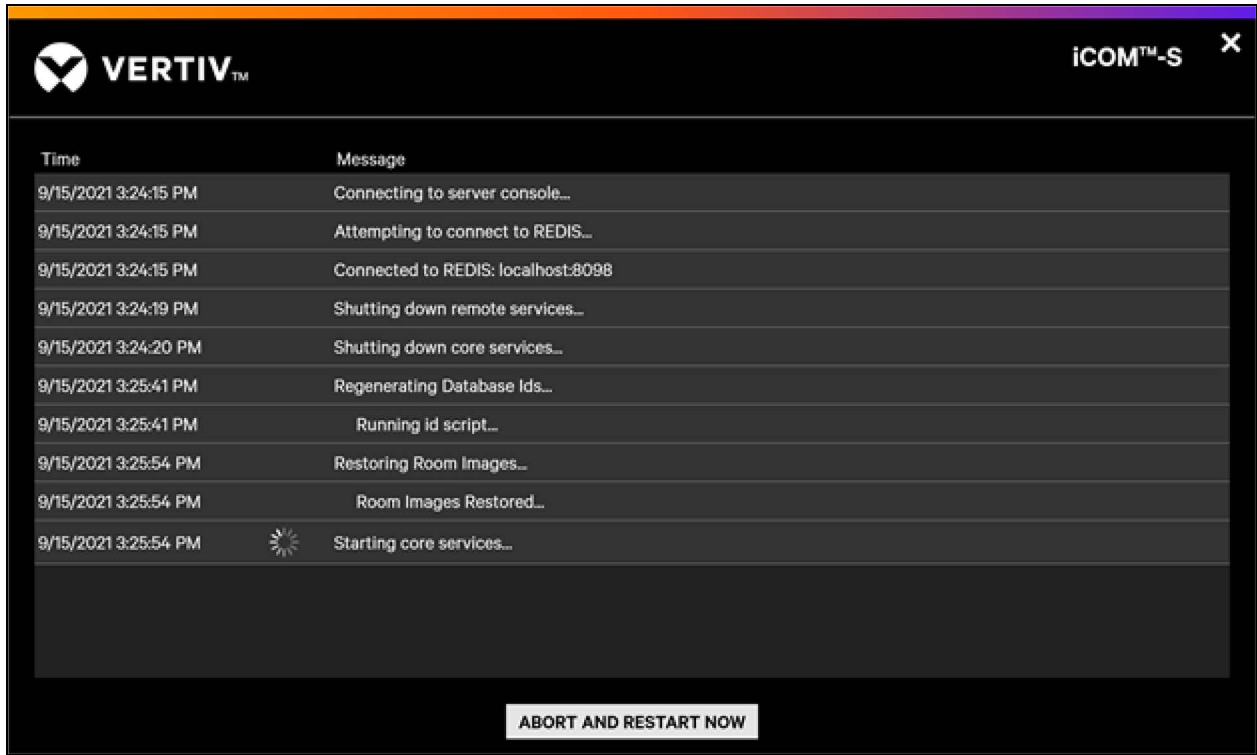

When this is finished, the UI will restart and present you with the Initial Quick Start Process, described in [Initial Quick Start Process](#) below .

### 5.3 Initial Quick Start Process

The Initial Quick Start process guides you through a few important items as you set up your Vertiv™ Liebert® iCOM™-S system.

**NOTE:** In any of the following steps, pressing Cancel will exit the entire Quick Start process. To enter back into it, you can stop and restart the UI. If you have not yet defined a room in your site, the UI will take you to this Initial Quickstart process again.

If a Room has already been defined, the Quick Start can be reached by the Connect & Control menu -> Quickstart menu but initial networking, accounts, and firewall screens will not be shown.

Figure 5.7 Welcome Screen, Quick Start

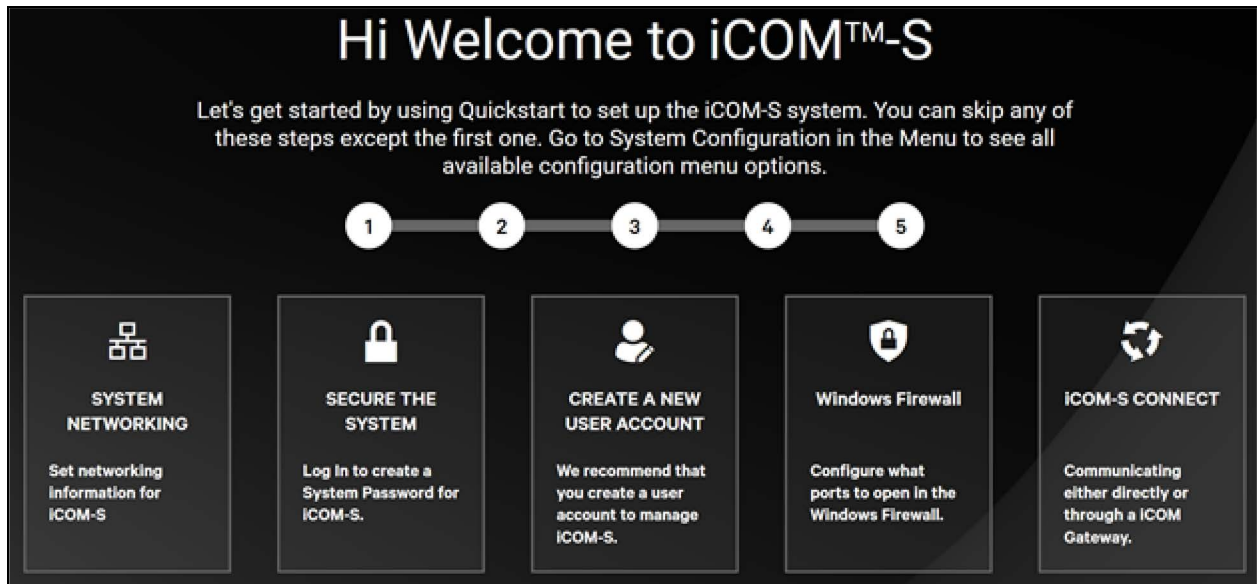

### 5.3.1 System Networking

Select System Networking to define the networking information for your system. The Quick Start process will find the networks already existing on your system and present them in a list.

**NOTE:** It is not always necessary to define the system IP address here. Many times, the IP address has already been set up by IT using the Windows Networking Control Panel. In this case, the resulting list will already have the desired IP address.



**NOTE:** The typical IP Address for Vertiv™ Liebert® iCOM™-S is 192.168.254.253. If you installed the UI separately as a Remote Client UI, then you had to specify this address during installation, as seen in [Installing the Remote Desktop UI Application](#) on page 47 .

Figure 5.8 Vertiv™ Liebert® iCOM™-S Network Interfaces

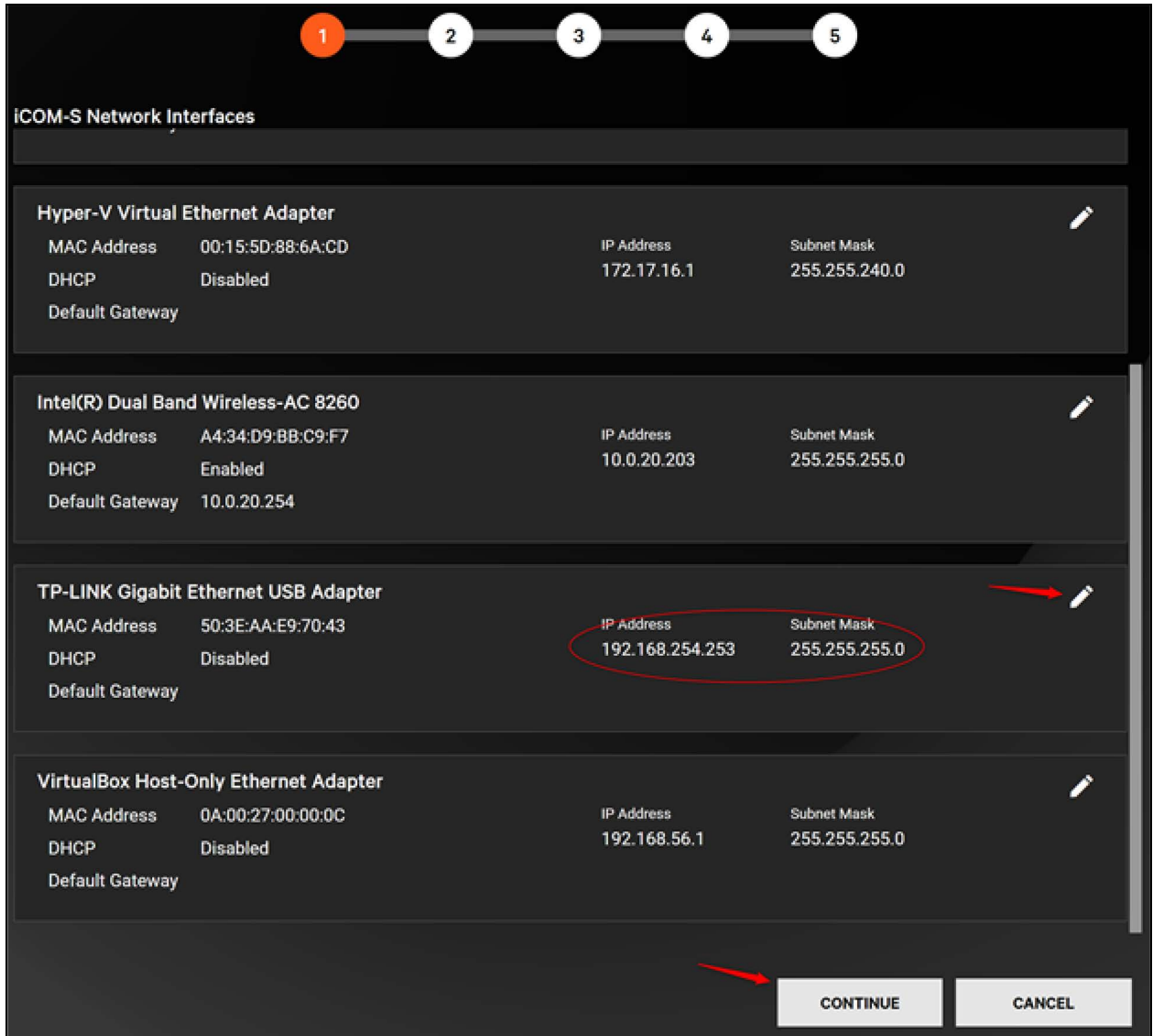

If you need to modify the network properties, then pressing the pencil button will allow you to modify the IP Address, Subnet Mask, and an optional Default Gateway.

**NOTE:** Liebert® iCOM™-S requires a static IP address, since that is how remote devices, such as remote UIs or Gateways, communicate with the iCOM™-S services. The DHCP selector should be off.

Figure 5.9 Marvel FastLinQ Edge 10Gbi9t Network Adapter

**Marvell FastLinQ Edge 10Gbit Network Adapter**

MAC Address A4:BB:6D:48:24:FF

DHCP

IP Address

Subnet Mask

Default Gateway

**SAVE** **CANCEL**

Select **Save** to save your changes or **Cancel** to discard your changes and return to the Network Interfaces list.

On the Network Interfaces list, press **Continue** to advance to the next Quick Start step.

### 5.3.2 Changing System User Password

This step allows you to change the system user password. Vertiv™ Liebert® iCOM™-S is delivered with a default Super User profile with an initial password:

**Login ID:** RduSupervisorSystem

**Password:** V3rtiv

At this point you must enter a password in the screen shown below.

**NOTE:** Since this profile has an initial password, even if you were to cancel out of the entire Quick Start process and attempt to log in using this ID, you would still be required to enter a new password. Once you have, you won't need to do it again.

Figure 5.10 Create System Password

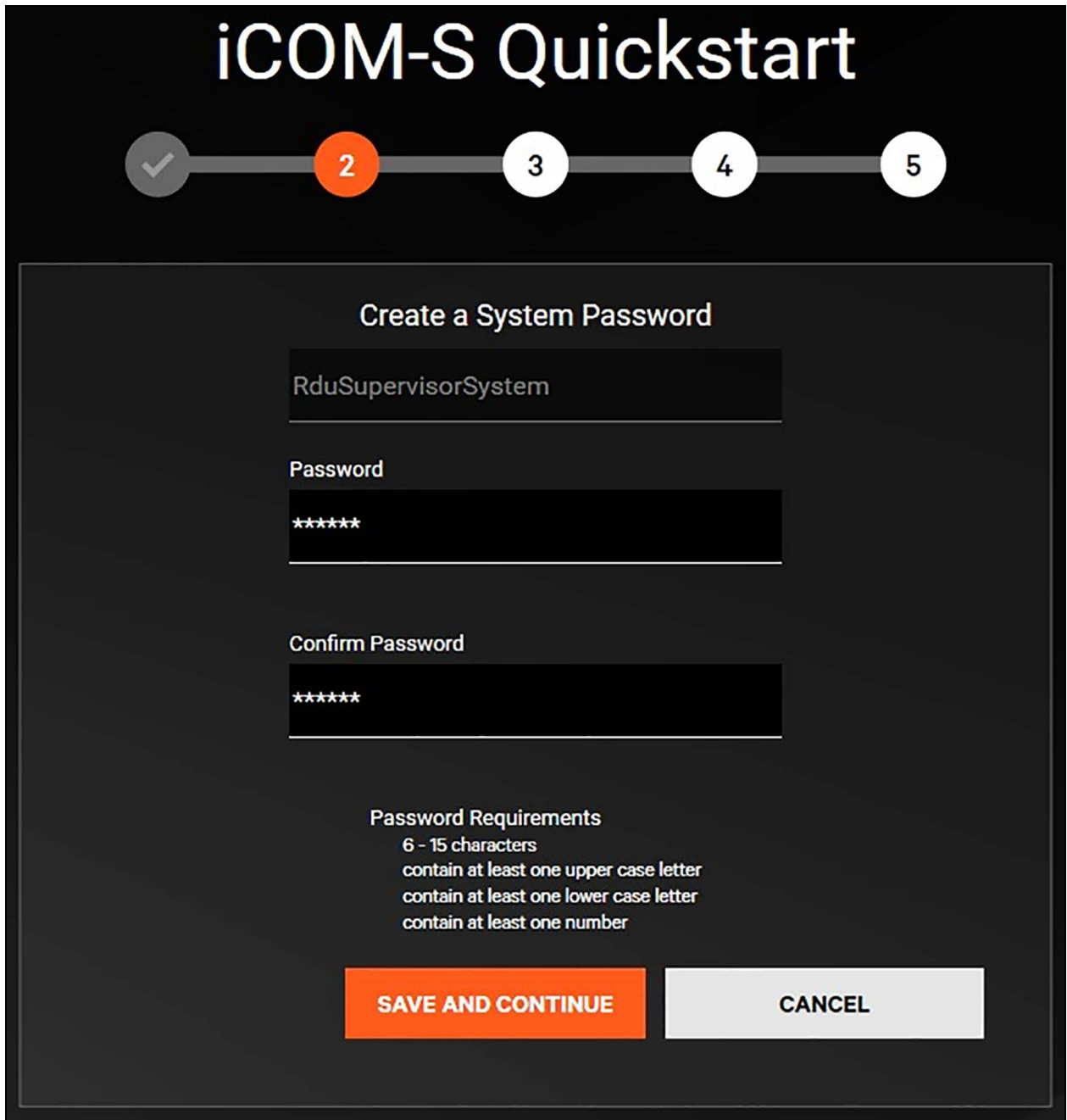

This is a typical change password screen. Enter the new password and enter the new password again in the confirmation box. Select **Save and Continue**.

**NOTE:** If the password for the default super user is forgotten and there are no other administrators or super users, troubleshooting and modifying Liebert® iCOM™-S is impossible.

**NOTE:** The automated daily full system backups performed by the Liebert® iCOM™-S password protects the backup file with the RDUSupervisorSystem password that is set.



### 5.3.3 Create a New User

This step allows you to create new users.

Figure 5.11 Create a New User

**Create a new user**

User Information	Security
User Name User.Name	Access Level Local User
First Name User	Enabled <input checked="" type="checkbox"/>
Last Name Name	Web Access <input checked="" type="checkbox"/>
Email Address test@vertiv.com	
New Password *****	
Confirm New Password *****	

SAVE CANCEL

On the left side of the screen you define the user's name and email address. Vertiv recommends using the employee's FirstName.LastName for the user name. This is easily recoverable when forgotten.

When creating a new user profile, the current user will create a new temporary password to use for initial sign-in. Passwords require at least eight characters, one uppercase, one lowercase, one number, and one special character.

On the right side of the screen you specify the new user’s access level. There are four levels to choose from: Local User, Service, Administrator, and Super User.

**Figure 5.12 User Access Levels**

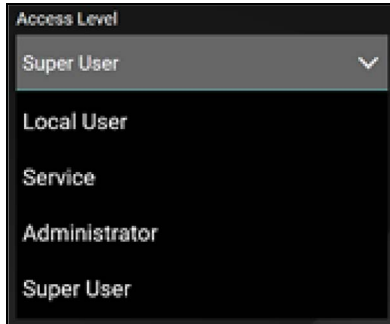

**NOTE:** Users of a certain access level can modify/manage users of a lower access level.

The **Enabled** selector indicates whether this new user should be enabled immediately.

**Table 5.1 Menu and Access Level**

Menu/Access Level	Local Users	Service	Administrator	Super Users
Home Screen	X	X	X	X
Reporting			X	X
Connect and Control	X	X	X	X
iCOM™-S Connect	X	X	X	X
iCOM™-S Clusters			X	X
iCOM™-S Groups			X	X
Wireless Gateway			X	X
Quick Start			X	X
<b>System</b>	X	X	X	X
System Information	X	X	X	X
User Access	X	X	X	X
Windows Firewall			X	X
Home Page Settings	X	X	X	X
BMS			X	X
BACnet Settings			X	X
Alerts and Defaults		X	X	X
Email Server Configurations			X	X
Site		X	X	X

**Table 5.1 Menu and Access Level (continued)**

Menu/Access Level	Local Users	Service	Administrator	Super Users
Service		X	X	X
iCOM™-S Software		X	X	X
Backup/Restore		X	X	X
Tools and Diagnostics		X	X	X
Low Level Settings				X
Support			X	X

**NOTE:** You can create a user, but set it as disabled. That user will not be able to log in to any Liebert® iCOM™-S UI until the account is enabled later.

The Web Access selector indicates if this user is allowed to use the web based UI.

When you are finished defining the user, press **Save** to create the user account. The form will be cleared, and you can define another user.

When you are done with all your users, select **Continue** to advance to the next Quick Start step.

### 5.3.4 Configuring the Windows Firewall

This step allows you to make changes to the Windows Firewall. Quick Start presents you with a list of installed Vertiv™ Liebert® iCOM™-S services that require passage through the firewall. By default, they are all checked.

**NOTE:** This list is shown if you are running the desktop UI on the Liebert® iCOM™-S appliance. This is where the Core services exist.

Figure 5.13 Configure Windows Firewall

System		Windows Firewall			
System Information		Drag a column header and drop it here to group by that column			
User Access		Name	Ports	Traffic Allowed	Description
Windows Firewall		iCOM-S - Authentication Service	8092	<input checked="" type="checkbox"/>	Service that provides user authentication support for iCOM-S
Home Page Settings		iCOM-S - BMS Service (BACnet)	47808	<input checked="" type="checkbox"/>	Service that provides BMS Connectivity via the Bacnet Protocol for iCOM-S
BMS		iCOM-S - BMS Service (Modbus)	502	<input checked="" type="checkbox"/>	Service that provides BMS Connectivity via the Modbus Protocol for iCOM-S
Alerts and Defaults		iCOM-S - Cloud Connector Service	8093	<input checked="" type="checkbox"/>	Service that provides Cloud Connectivity for iCOM-S
Email Server		iCOM-S - Configuration Service	8090	<input checked="" type="checkbox"/>	Service that provides configuration support for iCOM-S
Site		iCOM-S - Data Service	8091	<input checked="" type="checkbox"/>	Service that provides data retrieval and storage for iCOM-S
		iCOM-S - Ops Log Service	8094	<input checked="" type="checkbox"/>	Service that provides diagnostic logging for iCOM-S
		iCOM-S - SSDP	1900	<input checked="" type="checkbox"/>	Provides system device discovery protocol support for iCOM-S
		iCOM-S - stunnel Service	6379	<input checked="" type="checkbox"/>	Service that provides secure Redis connection support for iCOM-S
		iCOM-S - System Insights	8096	<input checked="" type="checkbox"/>	Service that provides system insights reporting for iCOM-S
		iCOM-S - Telemetry Service	8097	<input checked="" type="checkbox"/>	Service that provides telemetry connectivity for iCOM-S
		iCOM-S - Utility Service	8095	<input checked="" type="checkbox"/>	Service that provides general utility capabilities for iCOM-S
		iCOM-S - Web Site Service	443	<input checked="" type="checkbox"/>	Provides the web site for iCOM-S

In systems where BMS is not needed, you can disable the BACnet and Modbus ports. By default, all other ports should be allowed.

**NOTE: If you need to modify the firewall after the Initial Quick Start is finished, use the Windows Firewall control panel or navigate to the Connect & Control menu and select the Windows Firewall menu.**

Select **Continue** to proceed to the next step.

### 5.3.5 Additional First Login Activities

For details on adding devices to the system, refer to [Quick Start](#) on page 79

#### Modify Notifications

Modifying Notifications allow users to turn Critical, Warning, and Informational alert popups Off/On. This setting should be completed after Vertiv™ Liebert® iCOM™-S installation and setup.

##### To configure notifications:

1. From the System menu (Gear icon), select the **Alerts and Defaults** menu and select the **Alert Settings** menu.
2. Turn **Critical, Warning, and Informational Alerts** on and off in this menu.
3. Select **Save** once complete to save the changes.

**NOTE: When the system is first being setup or if there are massive changes being made to the system, it may be preferable to temporarily disable all notifications to reduce distractions.**

Figure 5.14 Modify Notifications

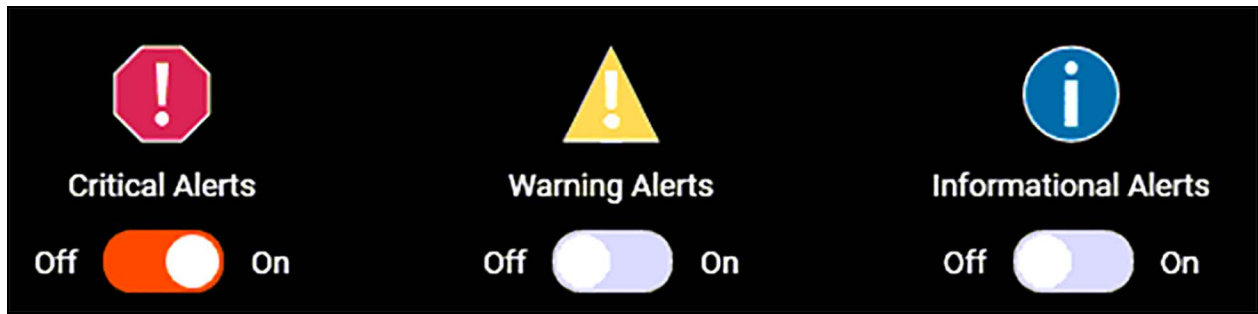

## Configure User Locale Settings

The Locale menu allows users to change languages or change units of measurements on specific parameters. The Locale Settings should be completed after Vertiv™ Liebert® iCOM™-S installation and set-up to assure all system setup is completed correctly.

To configure user locale settings:

1. On the title menu, select the user name drop down menu and select **Locale**.
2. On the locale setting change any parameters or decimals.

**Table 5.2** on the next page provides the parameters that can be changed.

**Table 5.2 User Locale Setting Parameters**

Parameter	Unit of Measurement	Decimal Place Range
Air Flow	Relative Humidity	0-2
Apparent Power	Kilovolt-Ampere, Volt-Ampere	0-3
Current	Amp	0 - 1
Dimension	Centimeters, Feet/inches, Meters, Millimeters	0-3
Disk Space	Bytes, Gigabytes, Megabytes	0 - 2
Energy	kW - Hr	0 - 1
Flow	CFM, Cubic Meters/Hour, Liters/Minutes, Liters/Seconds	0 - 1
Immutable Kelvin	Immutable Kelvin	0 - 1
Percent	Percent	0 - 1
Potential	Volts	0 - 1
Power	Kilowatt, Watt	0 - 2
Power Factor	Power Factor Percent	0-2
Pressure	Bar, Pascal, wc	0 - 7
Relative Time	Day, Hour, Milliseconds, Minutes, Seconds	0 - 1
Rotational Speed	RPM	0 - 1
Temperature	Celsius, Fahrenheit, Kelvin	0 - 1
Temperature Rate	dKps	0 - 1

**Table 5.2 User Locale Setting Parameters (continued)**

Parameter	Unit of Measurement	Decimal Place Range
Thermal Airflow Effectiveness	CFM/kW, CMH/kW	0 - 2
Thermal Capacity	BTU/hr, kW, Tons	0 - 2
Thermal Mechanical Efficiency	Efficiency	0 - 3
Velocity	Meters/Seconds	0 - 1

## Set System Altitude

After Vertiv™ Liebert® iCOM™-S installation and setup, you will need to set up the **Site Coordinates Altitude**.

### To configure System Altitude

1. In the user menu, select the System menu (gear icon) and the Site menu.
2. In the site coordinates section, edit the **Altitude** section and click Save.

**NOTE: The Altitude unit is measured in feet above sea level.**

## Modify Enabled System Metrics

When first setting up a system, users will need to set up metrics to be calculated and viewed in the home page.

### To enable/disable system metrics

1. On the **System** menu, select **Home Page Settings** menu and then select the **Calculation Table** tab. This will open the menu to allow you to change the metrics calculated and viewed.
2. On the dropdown menu, select which pages to customize. You can customize HVAC units, groups, rooms, or the site.
3. On the Site settings, click and drag on metrics you want to move from Enabled & Displayed, Enabled Not Displayed, or Not Enabled. Once complete, click **Save**.
4. On the HVAC Unit, Group, and Room settings, click and drag on metrics to move from Enabled to Not Enabled and vice versa. After completion, click **Save**.

**NOTE: The calculations/metrics that are enabled (either displayed or not) will be available for BMS connectivity/visibility. If metrics/calculations are disabled, they will not be available for communication to connected BMS/BAS clients.**

## User Session Expires

After signing in and being inactive for 15 minutes, the Vertiv™ Liebert® iCOM™-S will start a count down. If the user does not select the **Stay Logged In** button, the user will be logged out and sent back to the home.

In the Service menu, Low Level Settings menu, and Configuration items, users can change the session expiration length using **SessionExpirationSeconds** and **UserWarningSessionExpirationSeconds**.

## Create/Add Rooms

Users can either create or add rooms in the Quick Start menu or the Topology menu.

### To Create and Add Rooms in the Quick Start Menu

1. Rooms can be created on the fly using the Quick Start wizard when adding an Liebert® iCOM™-S Gateway, Wireless Gateway or manually adding a Thermal HVAC unit. This is done by typing in a new room name in the Room field (drop down) on any respective screen. To just add a room without adding equipment at the same time, refer to the next section below.

### To Create and Add Rooms in the Topology menu

1. Navigate to the **Connect & Control (Recycle icon) -> iCOM-S Connect menu -> Topology (tab)**
2. Select the Site level in the below Topology, click the "+" icon in the header, then select the Add Room option.

**NOTE: Groups can be added manually to the system outside of the Quick Start wizard using the same process but by selecting Add Group instead.**

## 5.3.6 Adding Objects to System

Refer to [Quick Start](#) on page 79 for instructions to add various objects to the system. This menu will walk users through add devices including Vertiv™ Liebert® iCOM™-S Gateways, Vertiv™ WSN Gateways, iCOM™-S Groups, and manually adding HVAC units that were not automatically discovered.

This page intentionally left blank



## 6 Diagnostic Utility

The Diagnostic Utility allows users to

- Verify the services are working correctly.
- Verify that all programs are running without issues.
- Diagnose problems on the Vertiv™ Liebert® iCOM™-S system.

The Diagnostic Utility will mostly be used by Vertiv Service but knowing some key aspects can be helpful in trouble shooting key issues.

### 6.1 Diagnostic Utility Menu

The Diagnostic Utility menu is divided into twelve sections. Below is a chart showing a description of all the sections with a description. This manual will also go more in-depth on specific sections.

**Table 6.1 Diagnostic Utility Sections**

Section	Description
Report	Shows the summary and status report of the iCOM™-S system. This will be discussed in a section below.
File System	Shows the file locations and the size of used and free space.
Database	Provides Online/Offline status. Allows service or users to run custom scripts. This section goes into more detail below.
Services	Shows all the services and status for each service on the system.
Program and Folders	Quick access to folders or other programs.
Ops Log	Journal that shows recent processes and functions. This will be discussed in a section below.
Audit Log	Journal showing when users sign in and make changes to the system.
Backup / Restore	Shows storage location of full backup and configuration files.
Config Editor	Low-level program configuration values. Vertiv technician modification only.
Users	Allows a manual bypass of the 10 minute waiting period after incorrect password lockout.
Event Listener	Developers can subscribe to specific programs running on the iCOM™-S system (local access only).

### 6.2 Report Menu

The report menu shows a summary and status report on the systems, units, and sensors. Users can select a title to expand and view the details on that section or select the **Expand All** or **Collapse All** button on the top of the screen to see all the sections at once.

Users can also save and export the report details.

To save the report:

1. Click the **Save Report** button.
2. Select the location to save the html file.
3. Open the html file in a browser to view the report.

## 6.3 Database Menu

**NOTE: Only trained technicians should use this section.**

The Database menu is helpful when looking at the individual databases and tables within those databases. Users can also check the used space or free space.

Technicians can also repair or fix issues in the database menu by clicking on a script like **Repair RDU Calculation Reporting** or by running a custom script that is provided by service or a technician.

## 6.4 Ops Log Menu

The Ops log menu shows processes and functions that are currently running on the Vertiv™ Liebert® iCOM™-S system. The Operations Log essentially is a system-wide journal where individual services (running natively on Windows or remotely on the Liebert® iCOM™-S Gateways) can log messages regarding health, performance, timings, re-initializations, configuration change events, etc. Users can use the filter buttons to sort the list or change the Query Type and duration on the top left of the screen.

Users can also export this report as a .xlsx file.

To export the ops log:

1. Select the **Query Type**.
2. Click the **Export** button
3. Click **Refresh** (data will refresh to selected parameters).
4. Click the **Export** button.
5. Select the location to save the html file
6. Open the .xlsx file to view the report.

## 6.5 Diagnostic Zip

The Diagnostic Zip is a way to pull information and logs from everywhere on the Vertiv™ Liebert® iCOM™-S system. Users can select a list of machine details and Liebert® iCOM™-S details to include in a report. A start and end date are used to select required information. This information can be saved in a folder or accessed and downloaded through the browser using <https://localhost:8100/Diagnostic>.

Figure 6.1 Diagnostic Utility

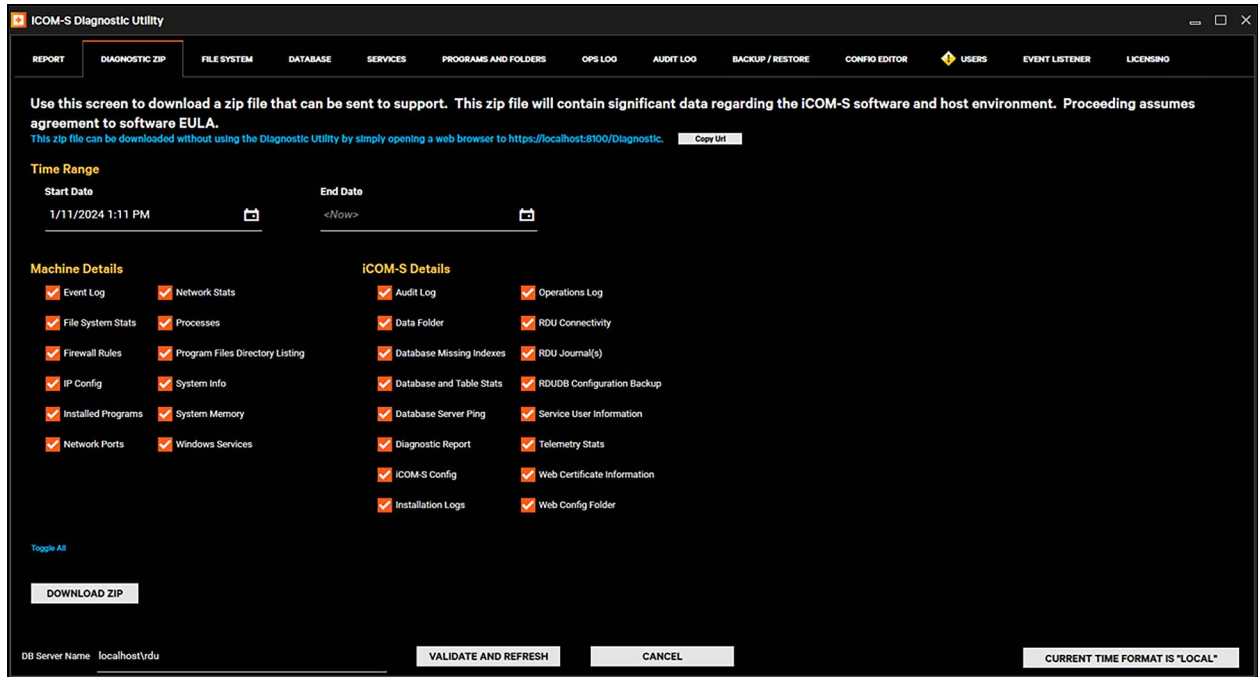

This page intentionally left blank

## 7 Vertiv™ Liebert® iCOM™-S User Interface

The following sections describe the Liebert® iCOM™-S User Interface.

Liebert® iCOM™-S shows data about each level of the cooling network. The Site level is the top level and by selecting a room, the Liebert® iCOM™-S will display its contents, including cooling units, gateways, and sensors, overlaid on a background image.

### 7.1 User Interface Layout

The following image shows the sections of the top-level view. On trending chart, users can add annotations or view the hierarchy view of what makes up the calculation.

Figure 7.1 User Interface Layout Top-Level View (Site)



Figure 7.2 User Interface Showing Annotations

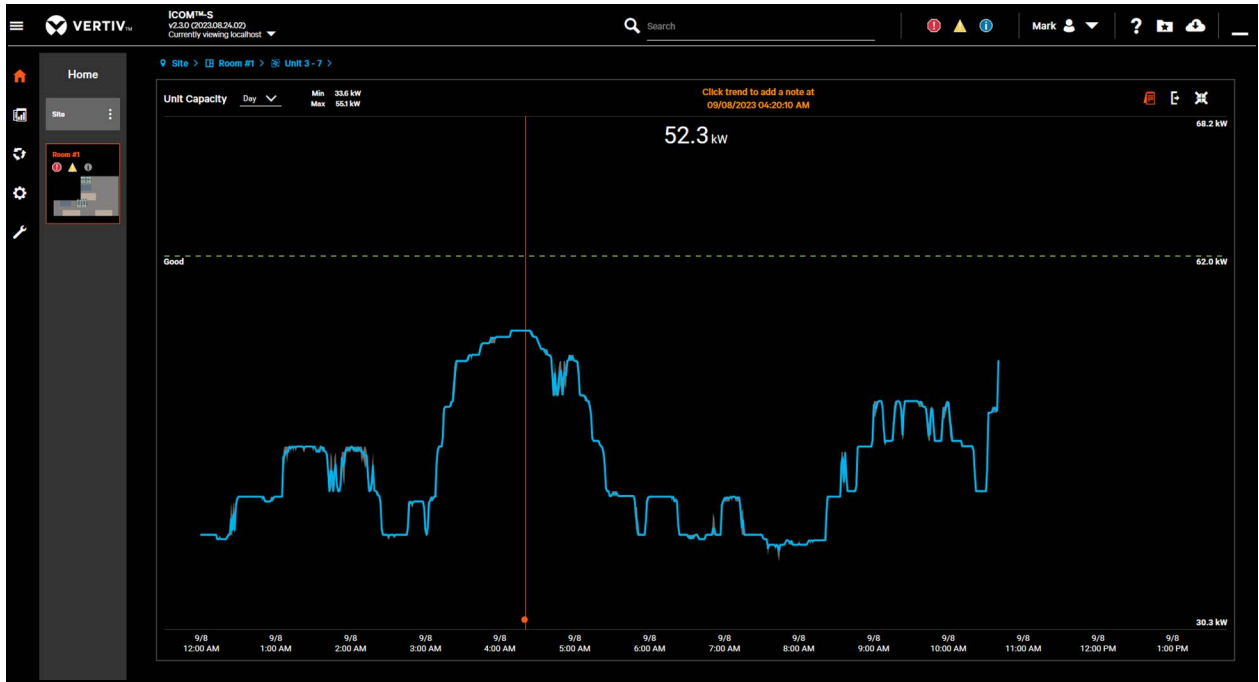
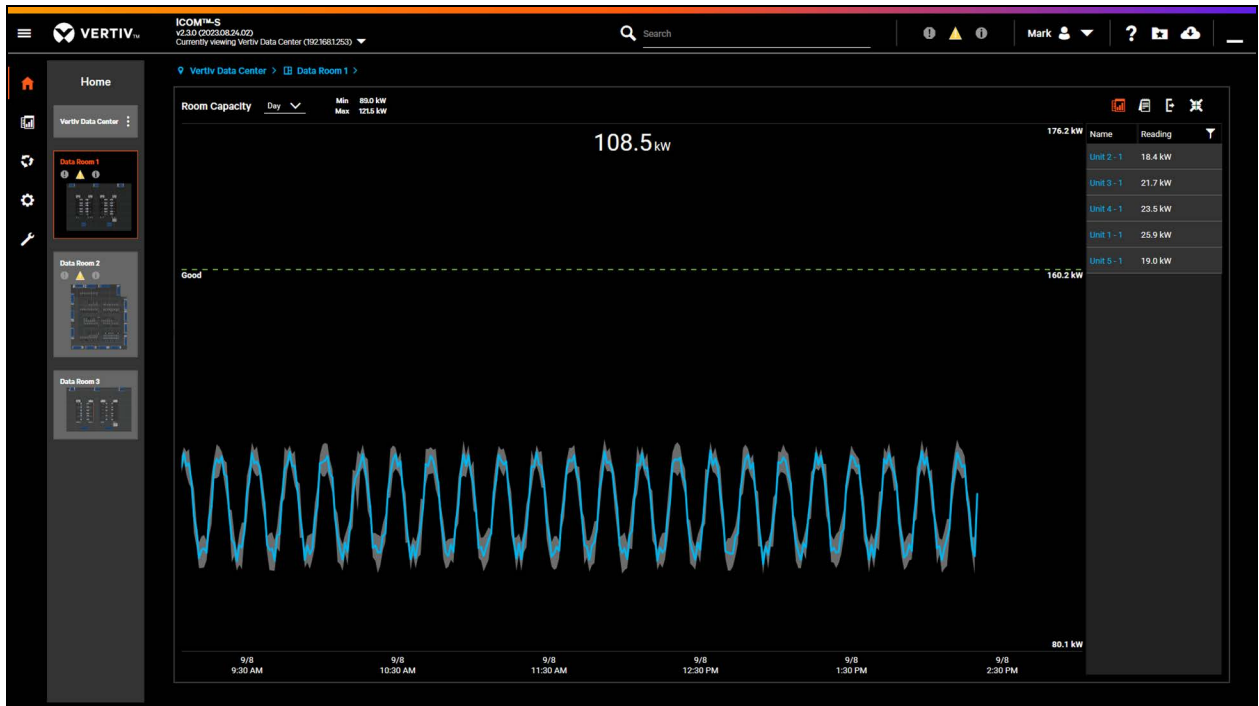



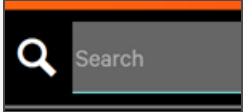

Figure 7.3 User Interface Showing Hierarchy View



### 7.1.1 Title Bar

The title bar is located across the top of the screen and contains the following items, from left to right.



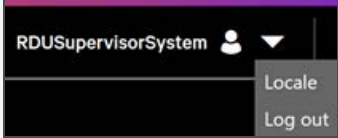
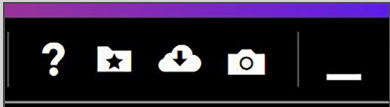
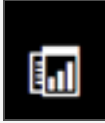



Table 7.1 Title Bar Items

Title Bar Items	Definition
	<p>The <b>View Menu</b> icon shows/hides the <b>View Menu</b>. This is discussed in further detail in <a href="#">View Menu</a> on the next page .</p>
	<p>The <b>Product Information</b> section identifies the current version of iCOM™-S and which iCOM™-S system is being displayed. If you installed the UI on the same system as the iCOM™-S core services, then this will display <b>localhost</b>. However, if you had installed a Remote Desktop UI, as described in <a href="#">Installing the Remote Desktop UI Application on page 47</a> , then this will display the IP Address of where the core services are running for the system in the current view.</p>
	<p>The <b>Search Tool</b> allows you to find components in the system, such as HVAC Units or Gateways. As you start typing the name of the desired component, a dropdown will appear showing names in the system that match what you have typed in. This list will be refined as you continue to type. If you see the component you want you can select it and the UI will go to that item.</p>
	<p>The <b>Notifications Button</b> will show the Notifications section, which appears as a vertical strip at the right edge of the screen.</p> <p><b>NOTE: The Notifications section is visible only if you are in the Home view.</b></p> <p><b>Clicking the Notifications Button a second time will not dismiss the Notification section. Instead, you need to click the close button located in the upper right corner of the Notification section.</b></p>
	<p>The <b>Current User</b> section displays the currently logged in user (or Login if no user is logged in). Pressing the down arrow button will open a menu that allows you to change the Locale information for the current user, or to log out.</p> <p><b>NOTE: If no user is logged in then the UI operates in an anonymous user capability, which affords limited read-only access to the system.</b></p> <p>The <b>Locale</b> menu allows users to change languages or change units of measurements on specific parameters. See <a href="#">Configure User Locale Settings</a> on page 61</p>
	<p>The <b>Miscellaneous Buttons</b> section contains the following buttons:</p> <p>The <b>Help</b> button presents help information.</p> <p>The <b>Favorites</b> button presents a Favorites list, which allows you to quickly go to your favorite views in the UI. To favorite a view in the UI, click the star button on that view. To remove a favorite from the list, either select the star button again from the view or select delete from the favorite list.</p> <p>The <b>Download</b> button will take you to the iCOM™-S Software Update screen, which allows you to check for updates, download and install updates. See <a href="#">Software and License Updates</a> on page 129 .</p> <p>The Minimize button allows you to minimize the iCOM™-S UI and access the Windows desktop.</p> <p><b>NOTE: Press Ctrl+W to exit full screen into a window that you can resize. Press Ctrl+W again to place the UI back into full screen mode, without the Windows border and title bar.</b></p> <p><b>NOTE: Press Ctrl+M to minimize the UI.</b></p>

## 7.1.2 View Menu

Clicking on the three bar menu icon in the upper left hand corner will show or hide the View icons, which appear in a narrow vertical strip located at the far left of the screen. Selecting one of these icons will change the entire contents of the screen.

**Table 7.2 View Menu Items**

View Menu Item	Definition
	Three bar menu icon to show or hide the View icons.
	The <b>Home</b> button will display either Site- or Room-level information. At the Site level, trend graphs for sitewide calculations will be shown. You can select which calculations appear in the Home Page settings, see <a href="#">Home Page Settings</a> on page 95. At the Room level, you will see Room-wide calculations in the upper left section. The lower half of the screen will display your Room floor plan, with your devices, such as HVAC Units and Gateways, displayed. In the upper right section, you will see a detailed trend graph of anything you select in the floor plan.
	The <b>Reports</b> button will present you with a way to define and schedule reports. More details can be found in <a href="#">Reports</a> on the facing page
	The <b>Connections</b> button will show you a hierarchical view of your connected devices, such as iCOM™-S Gateways and Clusters, HVAC Units and Groups, and Wireless Gateways and Radios. In each of these cases, you will be able to select them and see a list of current Point readings and Calculation values. See <a href="#">Connect and Control</a> on the facing page.
	The <b>System</b> button allows you to make various systemwide changes, such as defining user access, BMS properties, Site properties, etc. See <a href="#">System</a> on page 87
	The <b>Service</b> button allows you to accomplish various low-level functions, such as backup and restore, launch external tools, define configuration values, etc. See <a href="#">Service</a> on page 102.

## 7.2 Home

Clicking on the three bar menu icon in the upper left will show or hide the View icons, which appear in a narrow vertical strip located at the far left of the screen. Selecting one of these icons will change the entire contents of the screen.

Clicking on Home will redirect you to the top-level view. More details of the top-level view can be found in User Interface Layout.





## 7.3 Reports

Selecting **Report** will allow users to complete instantaneous reports, schedule reports to be automatically completed, or set a directory location on the for the reports to be saved.



A list of available reports is provided in [Reports](#) on page 141

### 7.3.1 Reports

The first menu item allows users to complete instantaneous reports.

To create a single report:

1. From the **View** menu, select the **Reports** menu. Then select the **Reports** Screen.
2. Select the **Report Type** to show all report types and parameters recorded in the report.
3. Select the destination for the report to be saved on the computer.
  - If no destination is available, select **Add a new destination**. Add a destination to save the report by clicking **Add a new Destination link** to the right of the Destination field.
4. Select the file type.
5. Select the beginning and end date and time, if applicable (historical type of report).
6. Select **Run Report**.

**NOTE:** Reports can also be saved as a compressed file to reduce the size of the file that is saved.

### 7.3.2 Scheduled Reports

Scheduled Reports allow users to automatically receive reports. To set up, click on the plus button (+) on the top right. First select the Report Type (Groups, Points, HVAC Statics, HVAC Statues, Alarms, Wireless Points, etc.), select the Schedule or frequency the reports will be sent, and select the Destination for the reports to be saved on the computer or emailed to a recipient (if setup).

### 7.3.3 Report Location

**Report Location** is used for users to add locations in the directory to save reports. Click on the plus button (+) on the top right and select either file or email. For saving to a file location, select the folder where you would like to save the report. For sending the report as an email, select email and enter the subject, body, and email recipients. If creating a file destination for the report to be saved, the user has the option of selecting a Maximum Folder Size and a Maximum Number of Reports. This prevents reporting from unsupervised filling up of the hard drive.

## 7.4 Connect and Control

The **Connect & Control** menu will allow users to view and configure the groups, clusters, gateways, and units of the system. This menu also allows users to view the Windows Firewall and the Quick Start menu.



### 7.4.1 Vertiv™ Liebert® iCOM™-S Connect

The Liebert® iCOM™-S Connect menu allows users to view a networking/data flow hierarchy from the iCOM-S all the way down to individual sensor data and properties of the end-device. Clicking on an object at any level shows all connected lower-level children devices. Objects or data are displayed to the right, making it easy for a user to understand the connectivity and data paths through the system. Redundancy and maintenance mode status icons are shown on the clusters (when present) to easily provide availability status to the user. Users can also see when devices are not communicating if the device has the icon next to the device.

Figure 7.4 Device is Not Communicating

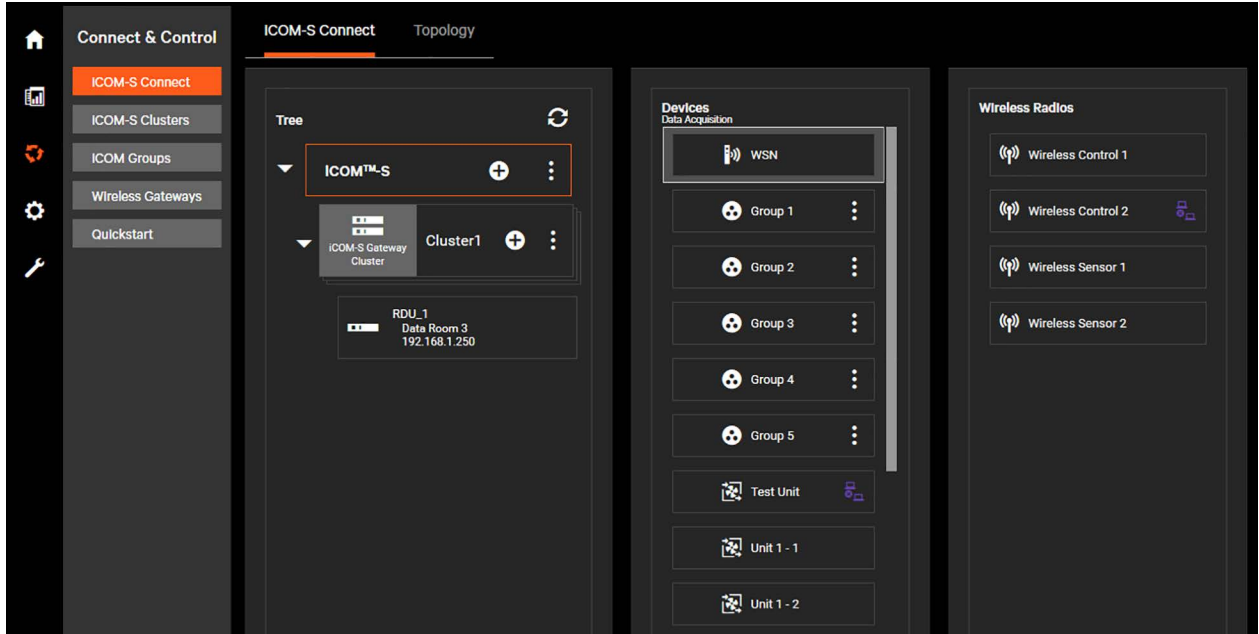

### 7.4.2 Vertiv™ Liebert® iCOM™-S Clusters

The Liebert® iCOM™-S Cluster page is for users to configure and edit clusters in the iCOM™-S.

The properties screen displays the Clusters (Cluster Details section) that have been created on the Liebert® iCOM™-S system. Clicking on a Cluster displays the Liebert® iCOM™-S Gateways that belong to that Cluster (Cluster iCOM™-S Gateways section) along with the functionality (protocols/calculation engines) running on that Cluster (Cluster Containers section) with their current statuses.

The cluster assignments screen allows manual changing of (automatically deployed) associations. Associations would include things like specific protocols running on a certain cluster are configured to communicate to specific groups of units.

The SSDP menu allows the user to enable/disable SSDP (simple service discovery protocol) on any network Interfaces on the Liebert® iCOM™-S Server. This mechanism is used to auto-discover the Liebert® iCOM™-S Gateways only (and not the thermal units themselves).

### 7.4.3 Vertiv™ Liebert® iCOM™ Groups

The Liebert® iCOM™ Groups menu (Connect & Control) allows users to manage aspects of iCOM™ Unit Groups. This includes the following functionality:

- Managing the temperature sensor associations to groups of HVAC units for purposes of control (Point to Group Association tab)
- Enabling control and the mode of Hot Spot Protection control on specific HVAC unit groups (iCOM™ Control Groups tab)
- Single Unit -> Single to Multi-Unit Fan and Cooling Set Point modification (Control Group Set Points tab)
- Mass Liebert® iCOM™-S HVAC unit property (name, model, performance, U2U ID) modification (HVAC Unit Change tab)
- Scheduling specific sensors to be ignored from control calculations for maintenance activities (Maintenance Mode tab)

**Figure 7.5 Liebert® iCOM™ Groups**

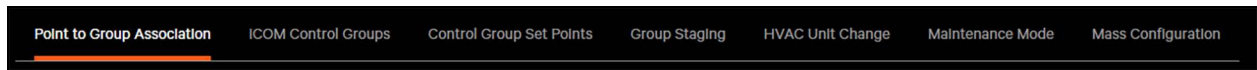

The **Point to Group Association** menu shows the units and sensors in the Liebert® iCOM™-S system. Each row contains the parameters of parent, name, location type, connection type, room, and current value. Each column can filter the parameters.

Clicking on any of the Group thumbnails on the right automatically filters the system list to show the HVAC units and associated temperature/control sensors for the selected group.

To edit the controlling group for units and sensors, click the edit button. Check the points you wish to update on the left and then select the groups above that should control.



**NOTE:** Clicking the Edit icon on a sensor will clear all the group associations so ensure all of the groups that should be controlled by that sensor are selected/re-selected before clicking Save. Using the Room Editor program is an easier way to edit these properties across multiple sensors/groups in a more efficient manner and is recommended.

The Liebert® iCOM™-S **Control Groups** tab allows users to set hot spot protection for specific groups. Select the group from the dropdown menu and then select on/off, and Good/Better/Best.

**Table 7.3 Liebert® iCOM™ Control Groups**

Item	Description
Best Hot Spot Protection	The most aggressive form of control in protecting against the warmest temperatures in the data center. Best Hot Spot protection controls off of the warmest sensor in the group.
Better Hot Spot Protection	Averaging form of control that uses the warmest set of sensors in the group for driving Unit fan/operation. This is the most common form of control used in the field and meets most applications. Better Hot Spot Protection is based on the average of the 5 warmest sensors in the group, ignoring abnormal values above the configurable threshold.
Good Hot Spot Protection	This is a nice compromise between protection and energy efficiency where variance of sensors drive the protective nature of the system. Good Hot Spot Protection is based on a proprietary sliding standard deviation that gets more aggressive/warmer as the average and density of the sensors are warmer.
Disable Control	Disable iCOM™-S control of the group, and each unit operates according to individual control settings.

**NOTE: Best will use the most energy, Good will use the most stable calculation, Better is used in 95% of deployments.**

**NOTE: If the Remote Auxiliary Sensor is enabled on these units, an alarm will occur when Liebert® iCOM™-S control is disabled.**

The **Control Group Set Points** tab is used to change set point values for groups. Select the group from the dropdown menu and then click on the box to the left of the unit name to select each unit. On the right side, adjust the fan speed set point or the cooling set point and send the updated set point to the units.

The **HVAC Unit Change** tab allows users to change the properties of the HVAC units connected to the Liebert® iCOM™-S. Select the group from the dropdown menu that contains the units that you want to change. For changing the unit's name, type in the new name and change the U2U ID if needed. Select **Save** when complete.

**NOTE: The U2U ID on this screen should align with the U2U ID set on the specific unit controllers/HMIs. Changing the U2U IDs on this screen *does not* change the corrected unit's U2U ID on the actual unit controller. U2U IDs cannot be duplicated. When changing the unit names and IDs, input and change everything at once.**

For changing the unit's model, click on the message on the bottom left:

**To enable changing the HVAC Unit model, select a new model.**

This will open a window that allows the users to select parameters such as manufacturer, models, and others from dropdown menus.

The Group Staging tab shows the current order of the units in the group and allows users to reorder this group staging order. Users will select EDIT and drag the units to the new order, then hit save. This can be done to any PA devices that have software PA2.06.57.01R.

**Figure 7.6 Group Staging Menu**

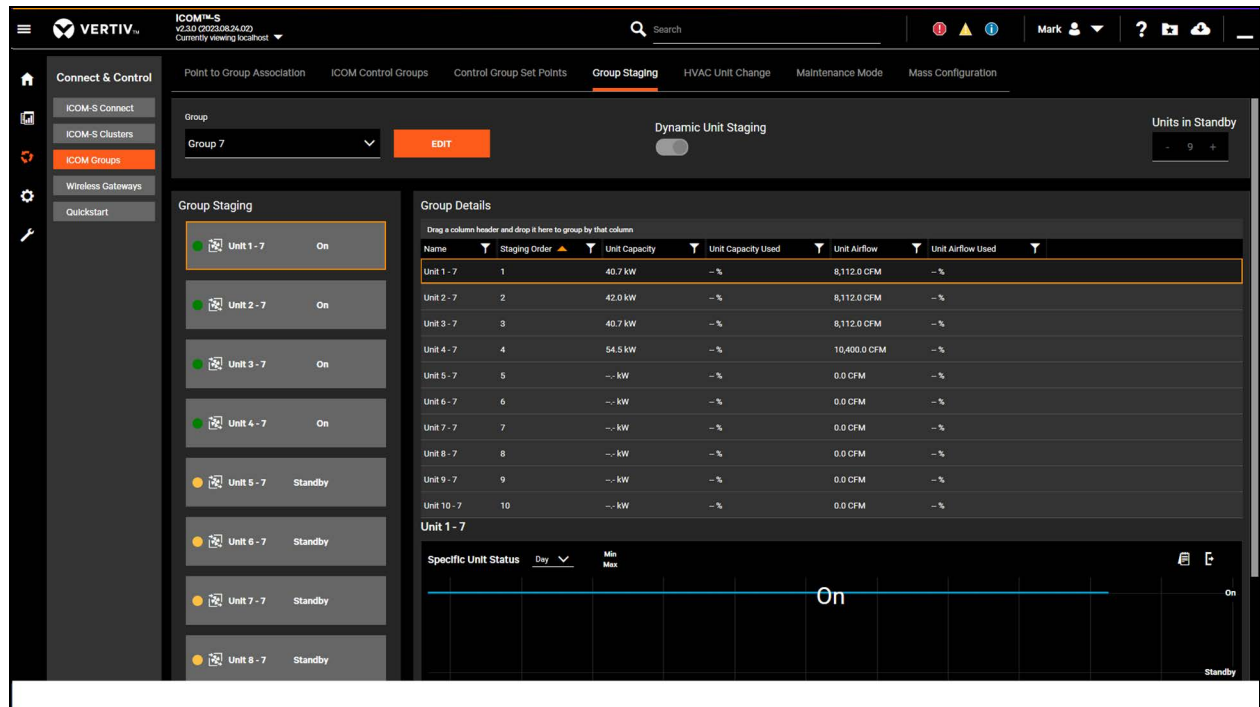

**NOTE: When selecting a new HVAC Unit, some parameters will auto-fill once enough parameters are selected.**

The **Maintenance Mode** tab allows users to put units and sensors into Maintenance Mode, a setting that disables the sensor's readings from being used in the control of calculations. The maintenance mode is useful when moving sensors around the site or working on the device. Maintenance mode can also be scheduled using the menu on the bottom. Users can set a Start and End date and click apply. When the maintenance window has elapsed, the sensor will automatically be included back into its associated group control modes.

**Figure 7.7 Maintenance Mode Duration**

**NOTE:** Users can clear all points from maintenance mode using the **Clear All Points from Maintenance Mode** button. This button is helpful when work is completed before the maintenance duration is completed.

The Mass Configuration menu allows users to verify parameter configurations in groups of units and to push these parameters to units if they do not align correctly. Users can select the group they want to verify, and a template to assign to the group. If the user wants to assign a new template, click the dropdown, select a new template, and select save. Selecting the gear icon will allow users to create a new template, copy an existing template to edit, import a template from another site, or export a template to be added on another site. See **Figure 7.8** on the next page.

Once a template is assigned, the menu will be filled with templates values and the unit synced and points synced values will populate. Selecting sub-menus will drive to the points in the menu. Selecting a point will populate the menu on the right showing the template value, each individual unit value, if the value is synchronized, and will give the units to push the value if it is not synced.

Figure 7.8 Mass Configuration

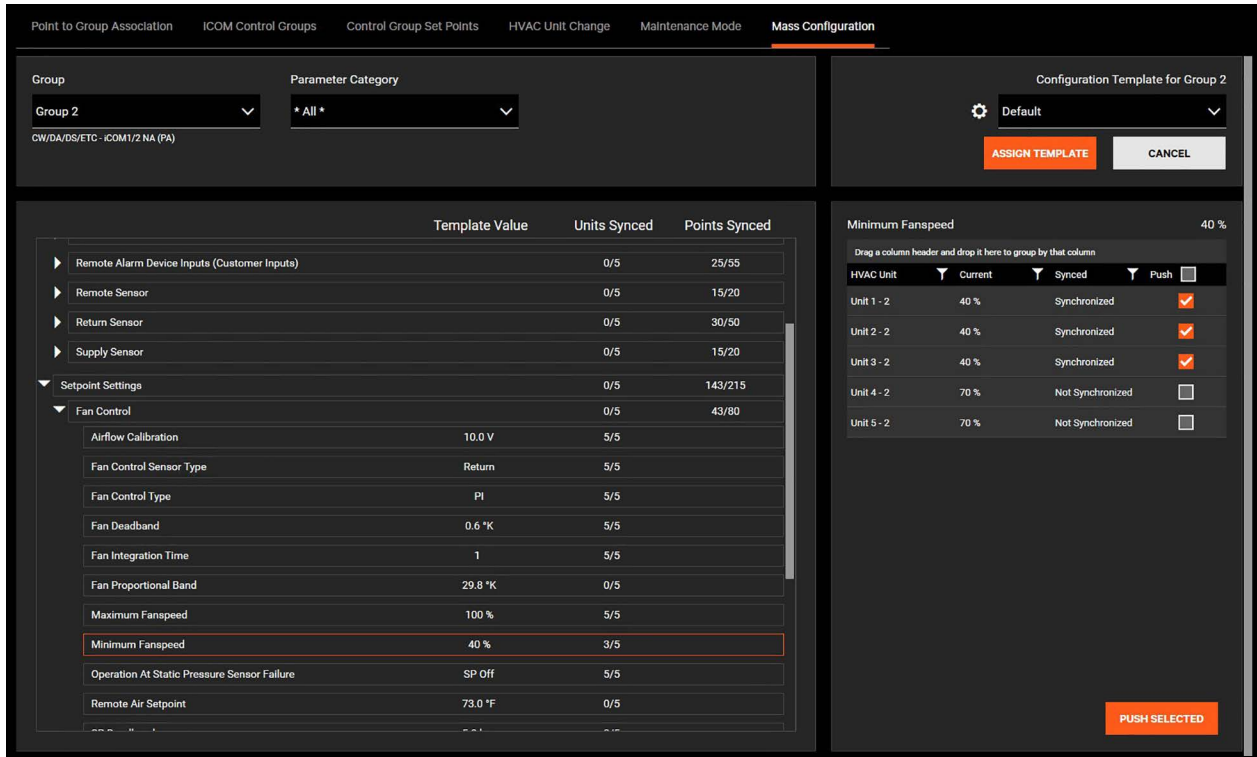

### 7.4.4 Wireless Gateways

**Wireless Gateways** menu is used to view and configure wireless gateways and wireless sensors. To add a new wireless gateway, click the (+) button on the top right to open the Add a New Wireless Gateway dialog.

Enter the Gateway Name, the room, the IP address, Manufacturer, Model, and the device it is connected to.

**NOTE:** If a wireless gateway firmware update is available, a notice is displayed next to the **Firmware Version** field stating so. Clicking on the three dots allows a user to update the wireless gateway firmware from the Vertiv™ Liebert® iCOM™-S.

**NOTE:** In the **All Wireless Radios** section, the user can click *Download latest wireless firmware* to save the latest sensor firmware to a user specified location (most likely to a USB drive). The file can then be used manually to update the wireless sensors per the instructions in the wireless user manual.

**NOTE:** To physically locate specific wireless sensors, click on the three dots on the same line as the sensors and select **Locate**. This will trigger a piezo buzzer on the wireless sensor within a polling cycle.

To change the configuration of the wireless gateways and sensors, click **Configuration Changes** near the top. Select to either configure the Gateway or the Wireless Radio, then select which Gateways or Wireless Radios to configure. Click on the box, edit the parameter, and click save to confirm the edit to be pushed to down to the wireless gateways.

## 7.5 Quick Start

This section is for adding devices to the system. This menu will help when initially setting up the system or adding new devices to the Vertiv™ Liebert® iCOM™-S.

Figure 7.9 Liebert® iCOM™-S Quick Start Page

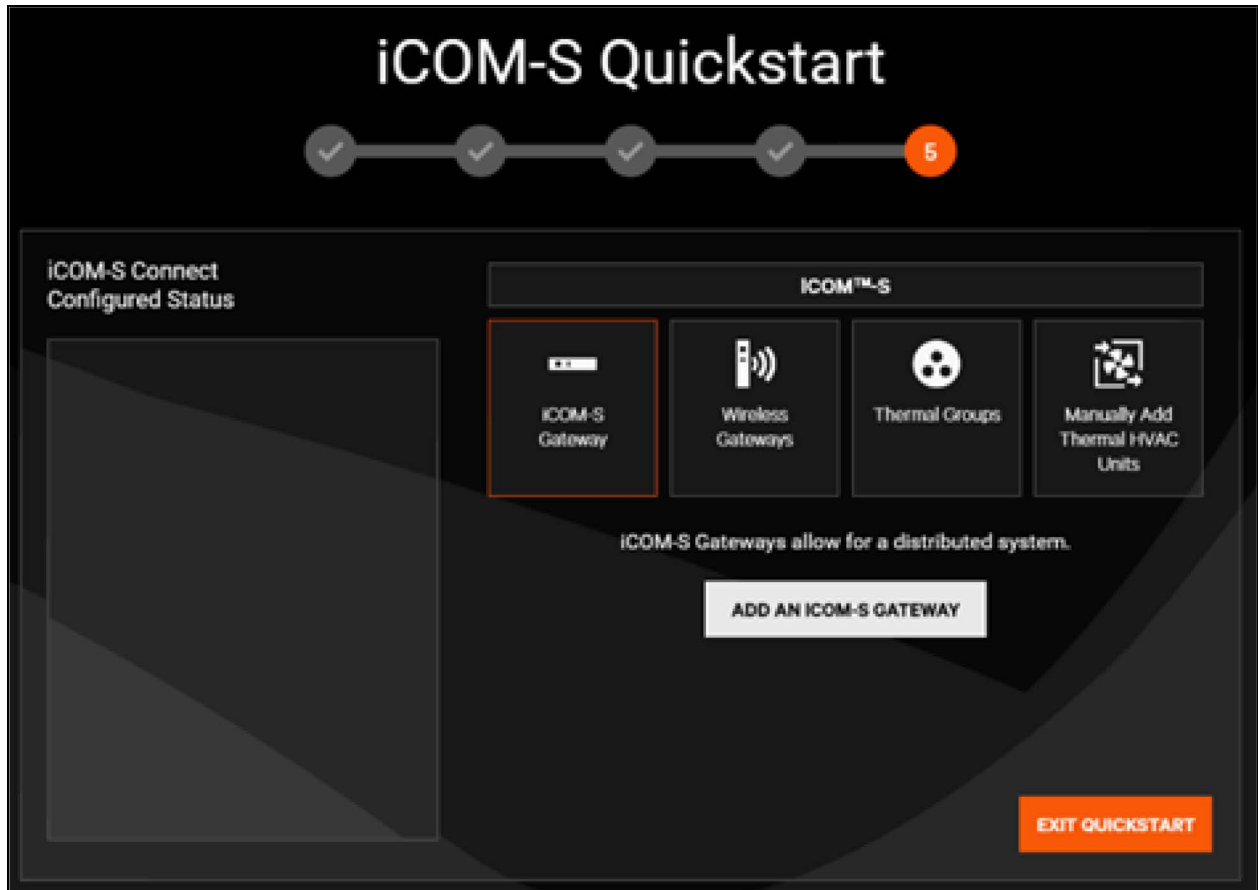

### 7.5.1 Adding Objects to System

The last step in this Initial Quick Start process allows you to add various objects to the system. This is the same as the Quick Start function that is available in the UI through the Connect & Control > Quick Start menu option.

Figure 7.10 Adding Objects to System

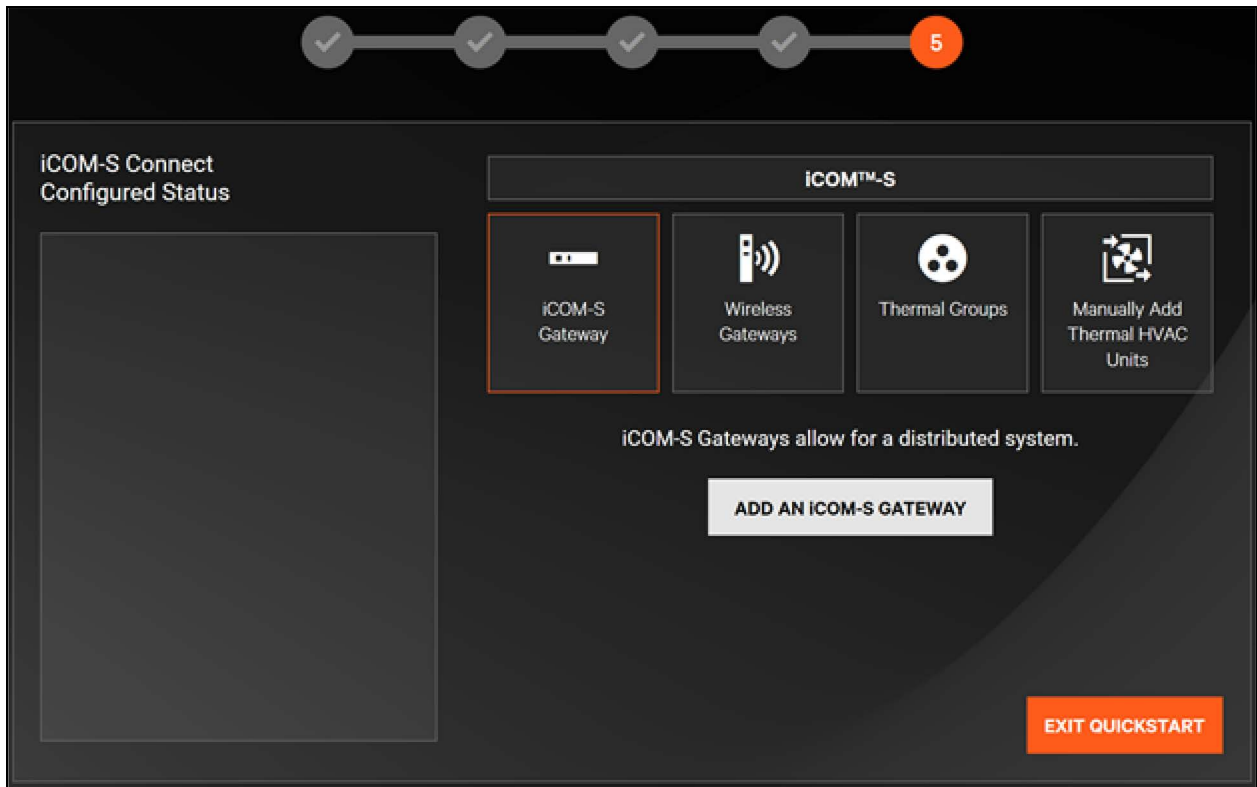

## 7.5.2 Adding a Vertiv™ Liebert® iCOM™-S Gateway (RDU301)



To add a Liebert® iCOM™-S Gateway (RDU301):

1. On the Quick Start menu, select iCOM-S Gateway and select **Add an iCOM-S Gateway**. This will open a menu to add a gateway.
2. Type in a Name for the gateway.
3. Select the IP Address of the gateway. If the device is correctly setup and connected, this IP address should already be part of the dropdown menu.

**NOTE:** For auto-discovery of the Liebert® iCOM™-S Gateway (RDU301), ensure that the connected IP address of the iCOM™-S to the Gateway has SSDP enabled. This can be found on the Connect & Control menu > iCOM-S Clusters > SSDP (tab) in the desktop UI.

4. Select the Core Server Network Address (iCOM-S typically pre-selected), Room the Gateway will be associated with, and Cluster the Gateway will be part of. If there is no cluster available in the dropdown menu, type in a name for the cluster and the system will create the cluster and automatically associate the Liebert® iCOM™-S Gateway to it.



Figure 7.11 Add New Vertiv™ Liebert® iCOM™-S Gateway

**Add a New iCOM-S Gateway**

**Name**  
RDU1

**Room**  
Room #1

**IP Address**  
192.168.254.1

**iCOM-S Gateway Cluster**  
Cluster1

**Core Server Network Address**  
192.168.254.245

**SAVE**    **CANCEL**

### 7.5.3 Adding Wireless Gateway



#### To add wireless gateways:

1. On the **Quick Start** menu, select **Wireless Gateways** and select **Add a Wireless Gateway**. This will open a menu to add a wireless gateway.
2. Type in a name for the Vertiv™ WSN gateway.
3. Select the room the gateway will be placed in from the dropdown menu. If the room is not available in the menu, type in the new room name and the Vertiv™ Liebert® iCOM™-S will create the room.
4. Enter the IP address of the wireless gateway.

This IP address should be the IP address that was configured on the Vertiv™ WSN Gateway Ethernet port that is connected either directly to the Liebert® iCOM™-S (on its network) or on the southbound side of the iCOM™-S Gateway cluster (on the same network as those ports). More details on configuring the Vertiv™ WSN Gateway Ethernet port IP address are explained in [Pre-installation Preparation](#) on page 13 .

5. Select the manufacturer, and model type from the dropdown menu. By default, this should be the manufacturer = Vertiv and Model = WSN Gateway.
6. Select what the wireless gateway is connected to in the final box. If the Vertiv™ WSN Gateway is networked directly to the Vertiv™ Liebert® iCOM™-S, select iCOM™-S. If the Vertiv™ WSN-Gateway is networked/will be communicating through Liebert® iCOM™-S Gateways, select the cluster of the associated Liebert® iCOM™ Gateway.

Figure 7.12 Add New Wireless Gateway

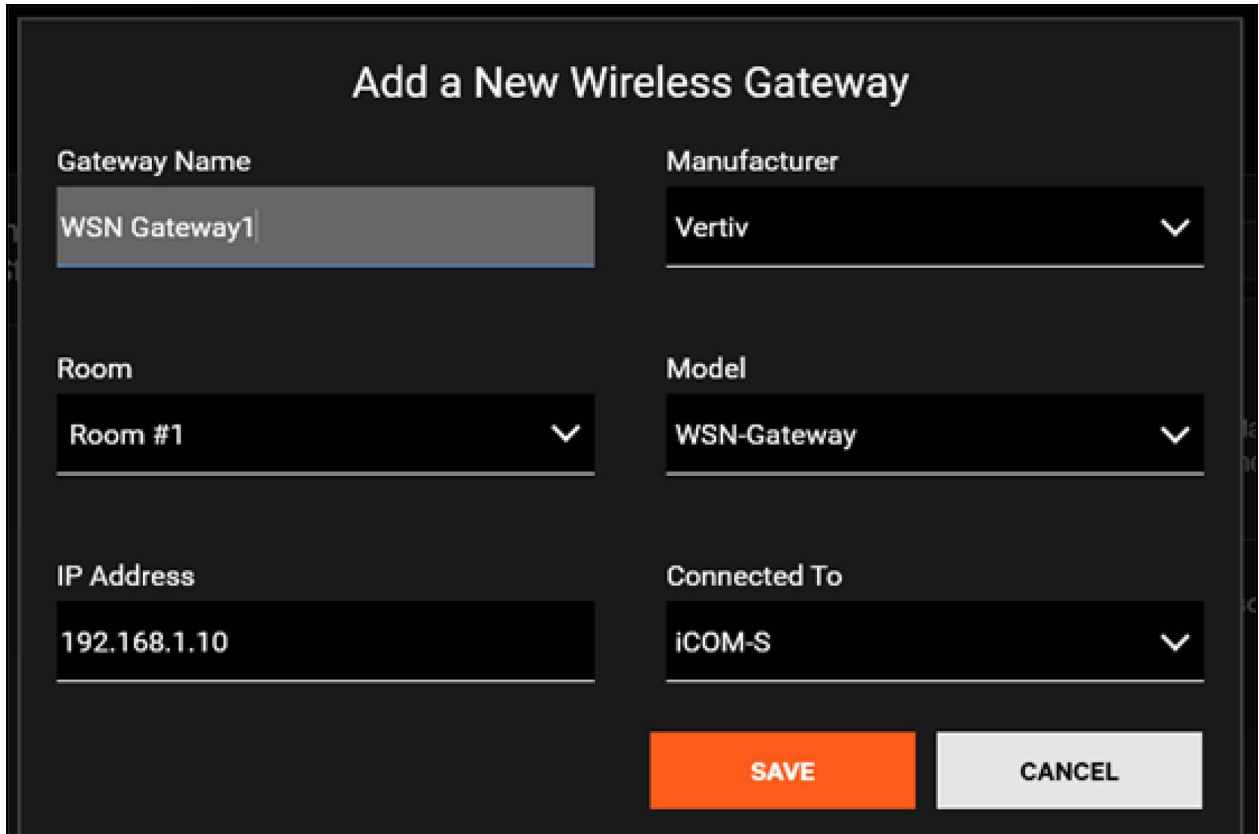

The screenshot shows a dark-themed configuration window titled "Add a New Wireless Gateway". It contains several input fields and dropdown menus:

- Gateway Name:** A text input field containing "WSN Gateway1".
- Manufacturer:** A dropdown menu with "Vertiv" selected.
- Room:** A dropdown menu with "Room #1" selected.
- Model:** A dropdown menu with "WSN-Gateway" selected.
- IP Address:** A text input field containing "192.168.1.10".
- Connected To:** A dropdown menu with "iCOM-S" selected.

At the bottom right, there are two buttons: an orange "SAVE" button and a grey "CANCEL" button.

### 7.5.4 Adding Thermal Groups

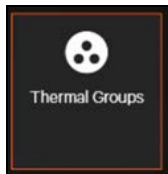

To add Thermal Groups:

1. On the **Quick Start** menu, select **Thermal Groups** and select **Add a group**. This will open a menu to add a thermal group.
2. Fill out the name for the new group. Select the group Identifier (Group ID set on the HVAC unit controllers), then select the Group Communication protocol.

If iCOM1/2 Group Communication Protocol is selected, proceed with the following group properties:

- **Support Device Models:** There are three primary families of Vertiv™ Liebert® iCOM™1/2 units. PA is the primary family that supports North America-based floor mount perimeter units (Vertiv™ Liebert® DSE, DA, DP, CW, etc.). CR is the family for North America Liebert® iCOM™1/2 CRV in-row units. A9H is the family for Liebert® iCOM™1 units primarily based out of EMEA.
- **Network Type:** This allows the user to select the applicable network scheme that aligns with the network properties set on the units in that group.
- **GBP Unit Identifier:** Default 64 is fine as the Liebert® iCOM™-S can dynamically change this to avoid conflicts with previously configured units on the group.
- **Aux Point Fallback and Temperature:** If all sensor inputs are lost, this is the time that the Liebert® iCOM™-S will wait before either communicating the last calculated control value or the Aux Point Fallback temperature (more conservative/protective).
- **IMPORTANT: Connected To:** Select how this group of units is networked to the Liebert® iCOM™-S. If directly connected, most likely for the panel/1U appliances, select iCOM™-S if communicating to the Liebert® iCOM™-S through a cluster of iCOM™-S Gateways, select the appropriate cluster.

After verifying the properties for the Liebert® iCOM™1/2 group, click Save. The units (if networked to the iCOM™-S and powered on) should start auto-discovering as pending units to be added to the system through the Connect & Control > iCOM-S Connect screen.

3. If iCOM™3 Group Communication Protocol is selected, proceed with the following group properties:

- **Aux Point Fallback and Temperature:** If all sensor inputs are lost, this is the time that the Liebert® iCOM™-S will wait before either communicating the last calculated control value or the Aux Point Fallback Temperature (more conservative/protective).
- **IMPORTANT: Connected To:** Select how this group of units is networked to the Liebert® iCOM™-S, if the units are directly connected (there is no RDU-301 gateway), select iCOM™-S (this is the most likely scenario for the panel 1U appliances). If communicating to the Liebert® iCOM™-S through a cluster of iCOM™-S Gateways, select the appropriate cluster.

After verifying the properties for the Liebert® iCOM™3 group, click Save. The units **will not** auto-discover and will now need to be manually added using Quick Start. See [Manually Adding Thermal HVAC Units](#) on the next page .

Figure 7.13 Add a New Group

**Add a New Group**

Name: Group 8

Network Type: Teamwork Thermal Default

Aux Point Fallback Timeout (sec): 120

Group Identifier: 8

Broadcast Address: 192.168.254.255

Aux Point Fallback Temperature (\* F): 82.40

Group Communication Protocol: iCOM1/2

Subnet Mask: 255.255.255.0

Supported Device Models: CW/DA/DS/ETC - iCOM1/2 NA (PA)

GBP Unit Identifier: 64

Connected To: iCOM-S

**SAVE** **CANCEL**

\* Ensure the iCOM-S PC IP Address is of type 192.168.254.xxx, has a subnet mask of 255.255.255.0 and is on the same network with the units in the group.

### Considerations When Adding Thermal Units to System

Depending on the unit types being added the process is slightly different. From a high level, groups need to be created before HVAC units can be added to the system.

Vertiv™ Liebert® iCOM™1/2 thermal units are auto-discovered after the group is created using the Quick Start. After the group is created, Liebert® iCOM™1/2 units show as pending on the Connect & Control -> iCOM-S Connect view where they can be added from there.

Liebert® iCOM™3 thermal units need to be manually added using Quick Start after the group is created using Quick Start.

The group properties/menus are different on the Quick Start based on the Group Communication Protocol selected.

### 7.5.5 Manually Adding Thermal HVAC Units

If there were units that were not auto discovered by the Vertiv™ Liebert® iCOM™-S system, users can manual add these by selecting the Manually Add Thermal HVAC Units.



#### To manually add a thermal HVAC unit:

1. On the **Quick Start** menu, select **Manually Add a Thermal HVAC Units** and select **Add HVAC Units**. This will open a menu to add the unit.
2. Type in the name of the unit.
3. Select the room, the group, and the unit identifier from the dropdown menus.
4. Select manufacturer, model, unit type, compressor type, model group and fan type from the dropdown menu. The menu might auto populate after some boxes are filled.

### 7.5.6 Adding a Chiller

1. To add a chiller into Vertiv™ Liebert® iCOM™-S, go to the Connect and Control screen and select the plus button, then "Add New Chiller".

Figure 7.14 iCOM™-S Connect

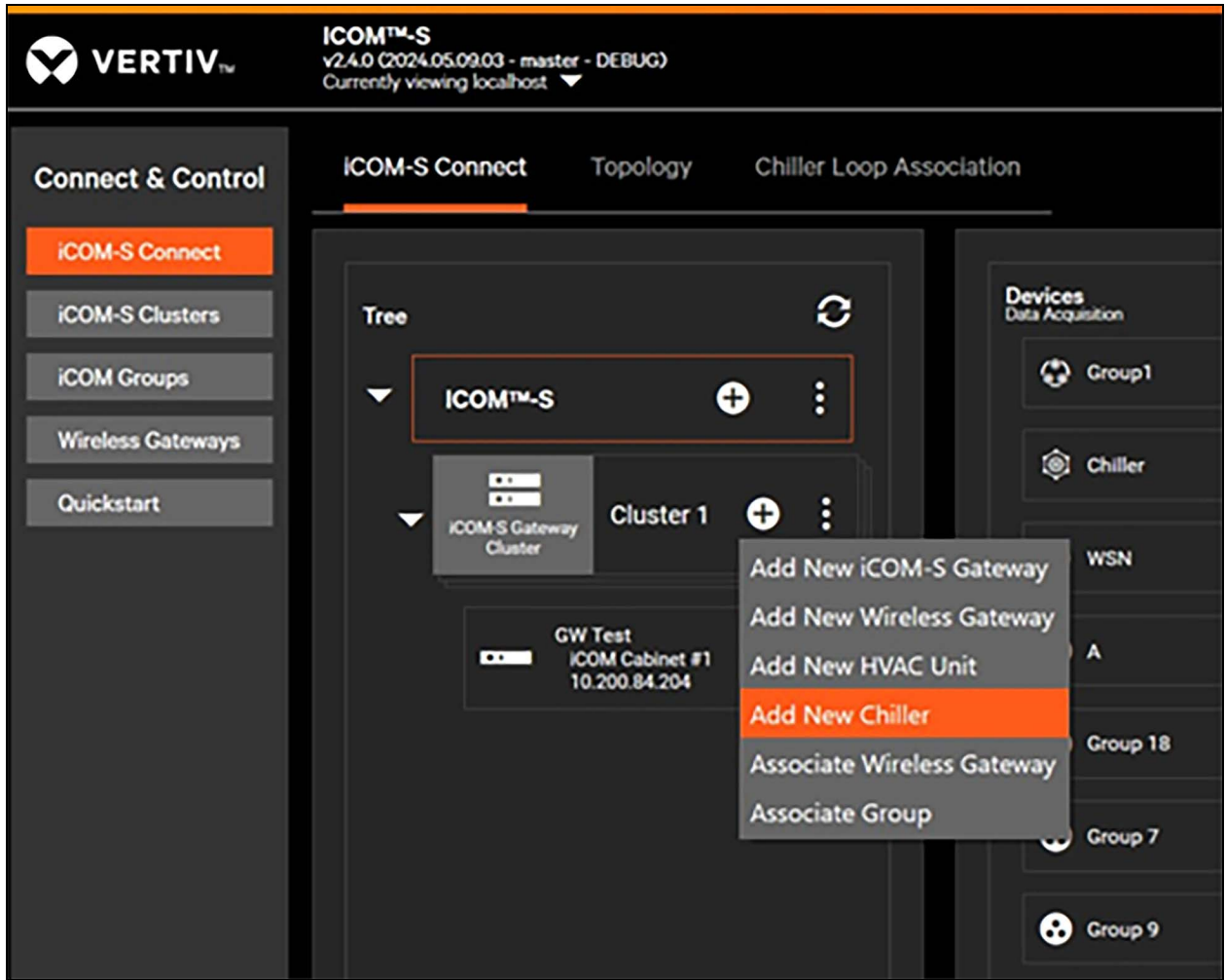

2. Fill out the Chiller Loop and Chiller Group. If there are already loops or groups available, select it from the drop down. If it is a new loop or group, type in the name and Liebert® iCOM™-S will generate the group or loop. Fill out the remaining values and select save to add the new chiller.

Figure 7.15 Add a New Chiller Screen

## 7.6 System

The **System** menu includes this information: system information, user access, homepage settings, BMS settings, alerts, email server settings, and site settings.



### 7.6.1 System Information

The Vertiv™ Liebert® iCOM™-S version information, system information, licensing information, and host server IP addresses can be found on the **System Service Configuration** page. Users can export panel information using the export panel info button. The third party licenses used by the system can be pulled up by clicking the button. The database sizes are also available on this screen. This helps users understand if there maybe be a database size issue. The available and used licensing can also be viewed on this screen. Users can import a license on this screen.

**NOTE:** The historical data can be cleared using the Clear History button. This will delete historical data but not the system configuration in any way.

**NOTE:** If the Liebert® iCOM™-S is connected to the cloud and a new license is available, users can click on Check Cloud License to automatically update their license.

Figure 7.16 System Information

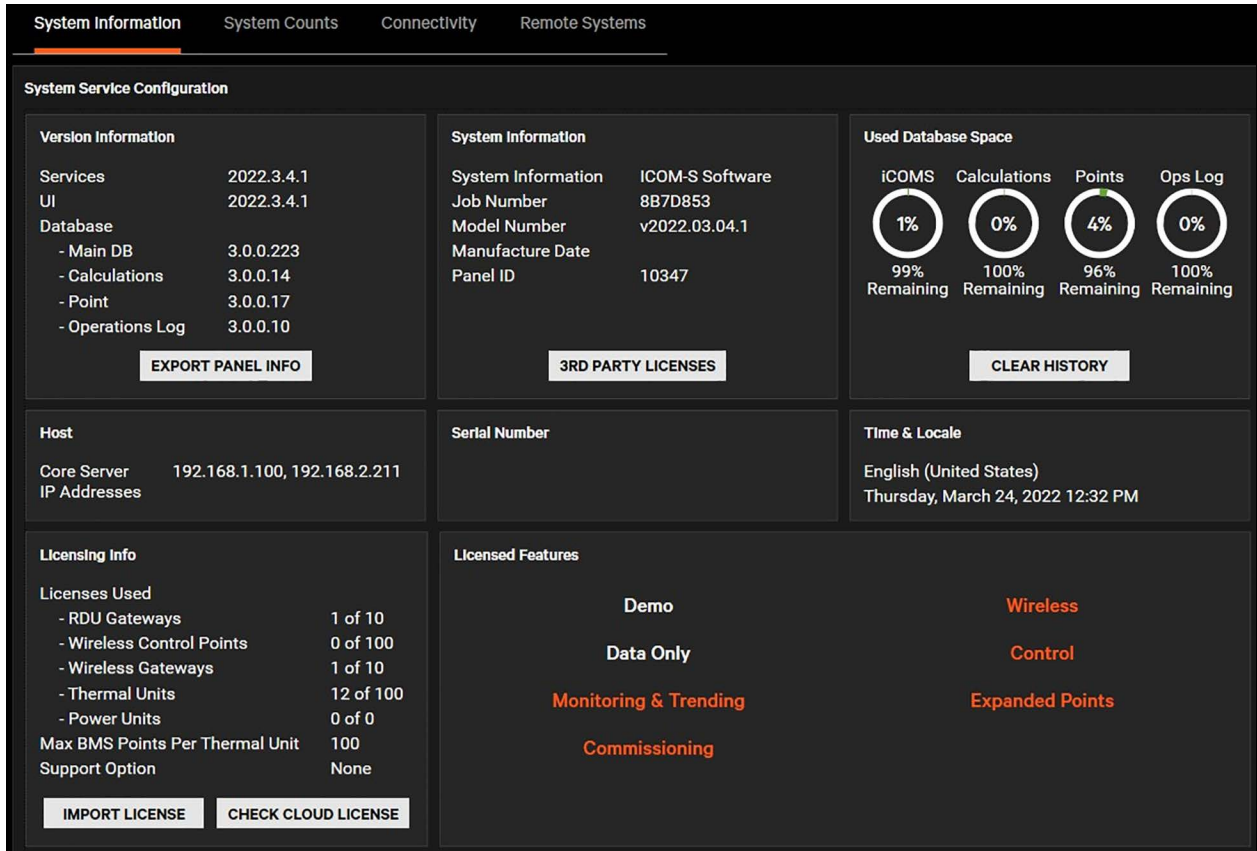

**System Counts** shows the user a visual view of licensing. The graph show the available units, the number of units used, and the percent of used to available units. This screen also displays the IP address of the HVAC and wireless gateways.



Figure 7.17 System Counts

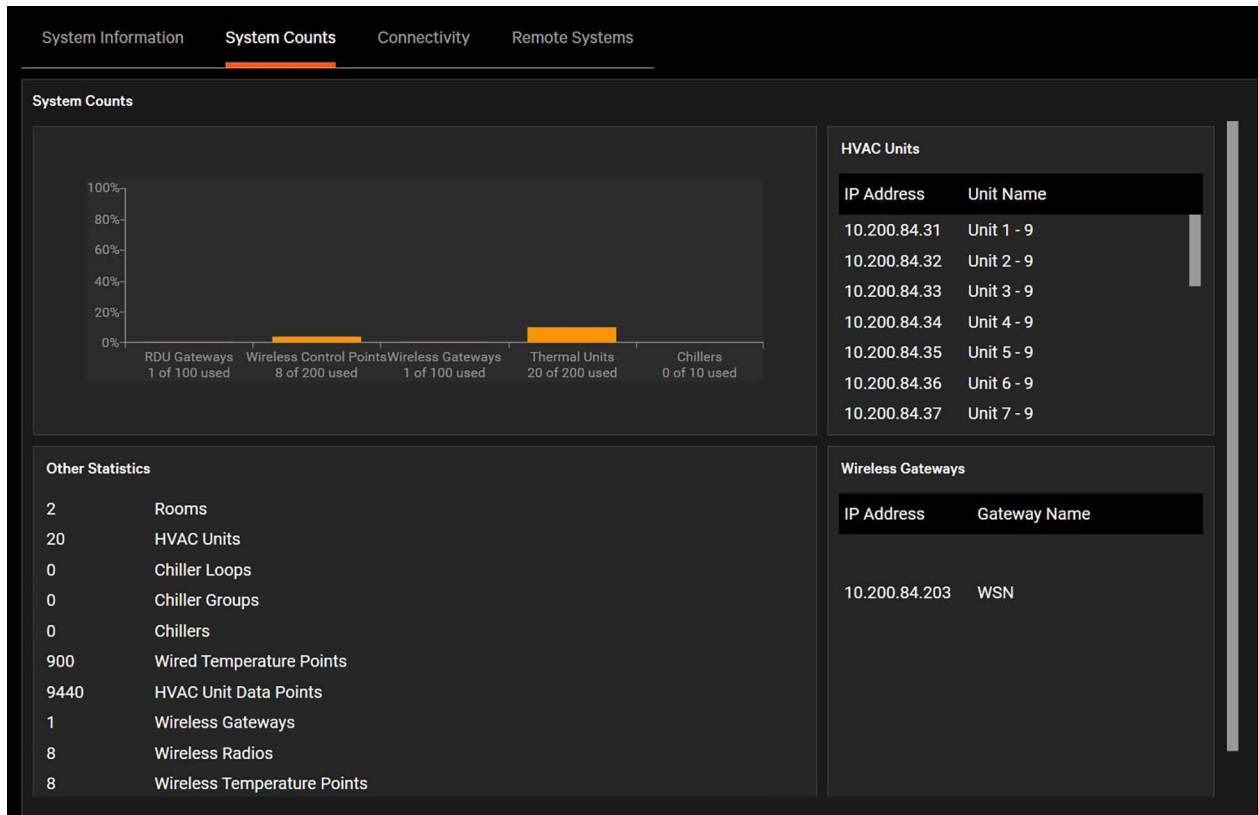

**Connectivity** tab allows the user to change the IP addresses of the available network interfaces (NICs) on the Vertiv™ Liebert® iCOM™-S system. Each device connected with the box will be included on this page. It shows the name, MAC address, DHCP enabled/disabled, IP address, subnet mask, and default gateway. To make any changes, click the pencil/edit icon to edit the address and click save.

**Figure 7.18 Connectivity Page**



**IMPORTANT!** Do not change DHCP to TRUE on the IP addresses that are used for Liebert® iCOM™-S/end device communication.

**NOTE:** Good verification practice after changing IP addresses is to navigate to Connect & Control > iCOM-S Clusters > Properties tab and verify that the Core Server fields for the Gateways are still accurate and updated (if applicable). Clicking the three dots on the Liebert® iCOM™-S Gateway line allows the Core Server IP to be changed if needed.

**Remote Systems** allows users to add additional Liebert® iCOM™-S systems to the UI (when installed as a standalone application). Users can run the Liebert® iCOM™-S remotely from another computer.

To add a Remote System, click the plus (+) to the right of the Remote Systems header. A list of available connected systems will show in the drop down. If the desired system is not shown select **\*\*Other\*\***. A popup will appear that will allow configuration of a Name and IP address. Enter these and select Save.

To switch between connected systems, select the drop down at the top of the screen where the software version is shown.

Users can also use the Web User Interface to connect remotely. See [Remote Web Browser](#) on page 49 for further details.

## 7.6.2 User Access

The **User Access** page is used to create and manage user profiles on the Vertiv™ Liebert® iCOM™-S. To add a user profile, click the plus (+) button on the upper right of the screen. Enter the User Name, First Name, Last Name, Email Address and Access Level. Then select if the user is Enabled and if the user has Web Access.

The following provides instructions for creating a new user's password.

When creating a new user profile, the current user will create a new temporary password along with providing the other information as seen in **Figure 7.19** on the facing page. Vertiv recommends using the FirstName.LastName schema for creating a user name.

Figure 7.19 Create New User

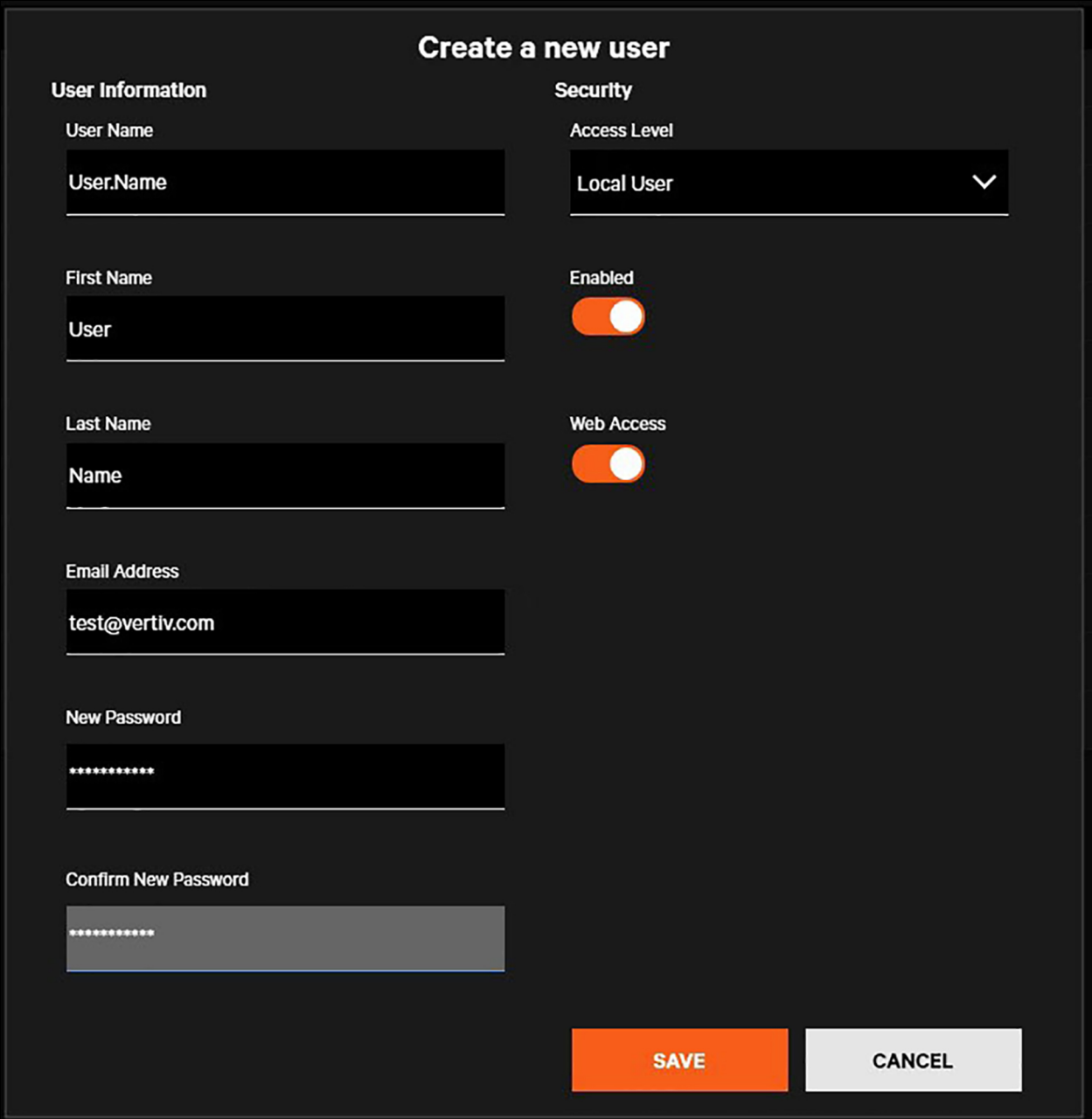

**Create a new user**

**User Information**

User Name  
User.Name

First Name  
User

Last Name  
Name

Email Address  
test@vertiv.com

New Password  
\*\*\*\*\*

Confirm New Password  
\*\*\*\*\*

**Security**

Access Level  
Local User

Enabled

Web Access

**SAVE** **CANCEL**

After clicking save, a notification is generated in the bottom right confirming that a new user was created and will show the temporary password set when creating the user. **Figure 7.20** on the next page shows the password created was **P@ssword321**. Passwords requires at least eight characters, one uppercase, one lowercase, one number, and one special characters.

**Figure 7.20 Notification New User Created with Temporary Password**

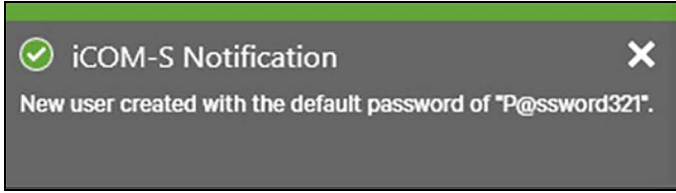

Have the new user login with their username and temporary password. In the example shown in **Figure 7.21** below when creating the user, the username is User Name.

**Figure 7.21 Login**

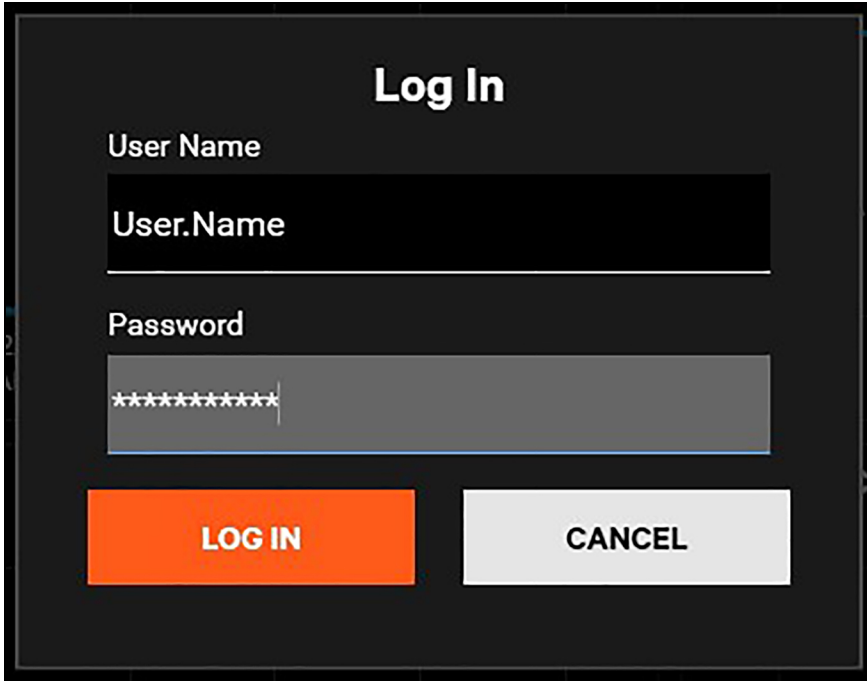

After logging in, the new user will be prompted to change their password which will become the user's new permanent password. Passwords now require at least eight characters, one uppercase, one lowercase, one number, and one special character.

Figure 7.22 Prompt to Change Password

The image shows a dark-themed dialog box titled "Log In". It contains two input fields: "User Name" with the text "User.Name" and "Password" with masked characters "\*\*\*\*\*". Below these is a section titled "Required Password Change" with two more input fields: "New Password" and "Confirm New Password". At the bottom, there are two buttons: "CHANGE" and "CANCEL". A "Password Requirements" section lists: "6 - 15 characters", "contain at least one upper case letter", "contain at least one lower case letter", and "contain at least one number".

All enabled users on the Vertiv™ Liebert® iCOM™-S system can be seen on the **User Access** menu with their Login Name, First Name, Last Name, Enabled status and Web Access Status. Users are never deleted, but they are disabled. To view disabled users, select the checkbox in the upper right corner of the screen to **Show Disabled Users**.

### 7.6.3 Windows Firewall

The **Windows Firewall** page shows all firewall services. It includes a table of names, ports, traffic allowed, and description. Users can filter any of these parameters. To enable and disable traffic for specific services, select the box and select **Save**.

The only two firewalls that should be modified without Vertiv technician assistance/verification are the BMS Service protocols. With that being said, disabling the BMS protocols could prevent anticipated BMS communication.

Figure 7.23 Configure Windows Firewall (Diagram)

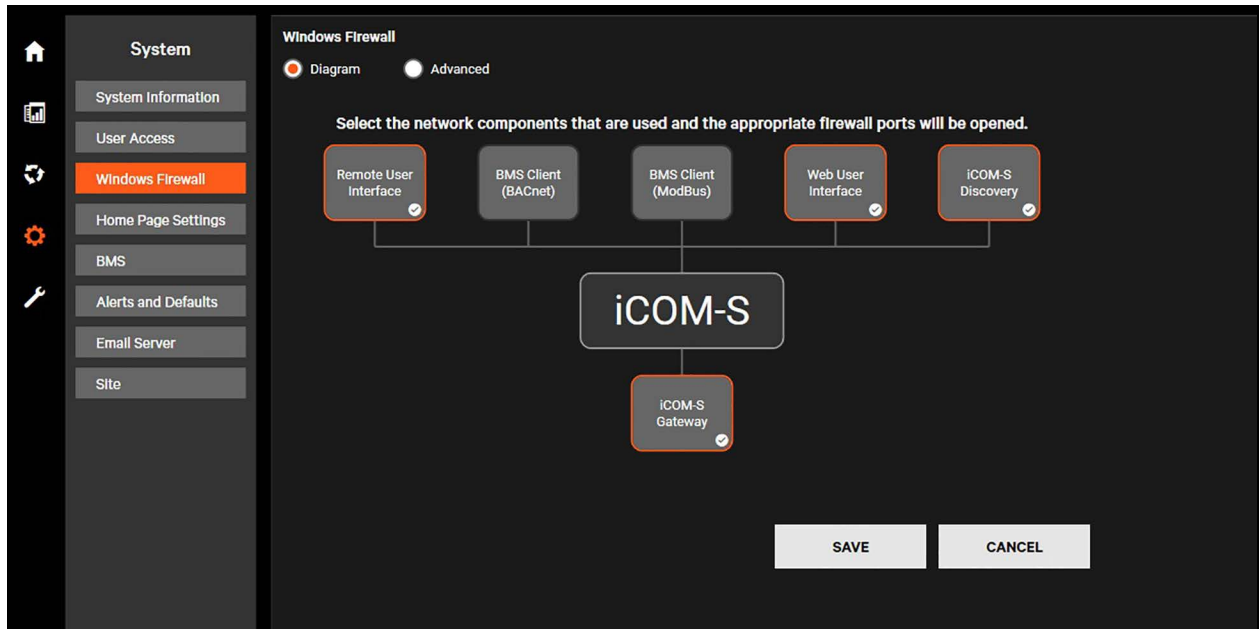
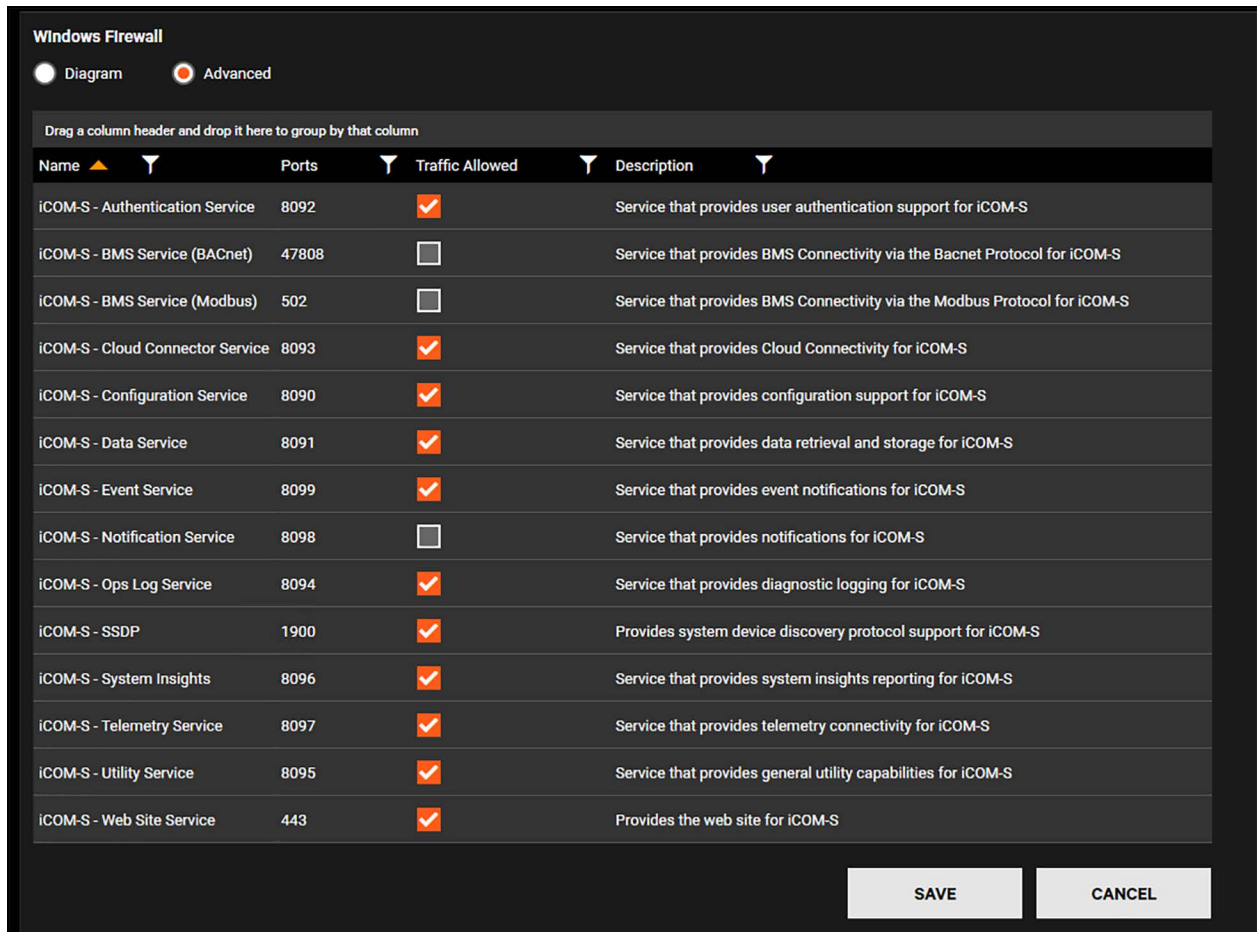

Figure 7.24 Configure Windows Firewall (Advanced)



## 7.6.4 Home Page Settings

The **Home Page Settings** page allows users to configure the data that is shown on the home page.

Figure 7.25 Home Page Settings Menu

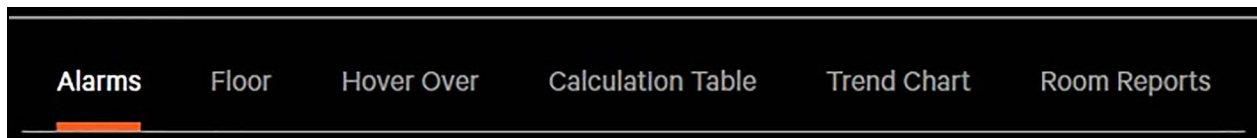

The **Alarms** tab allows for users to select the minimum roles that can minimize the alarm/notification panel.

**Floor Tab.** Users can view the Floor Plan Color themes for multiple units, sensors, alarms, and others. To change or view the color for a specific item, click on that item. A menu will appear on the item on the right. Users can now view the Name, Description, and Floor Highlights. Refer to **Figure 7.26** on the next page. New themes can be created, but existing themes cannot be modified.

Figure 7.26 Floor Plan Color Theme

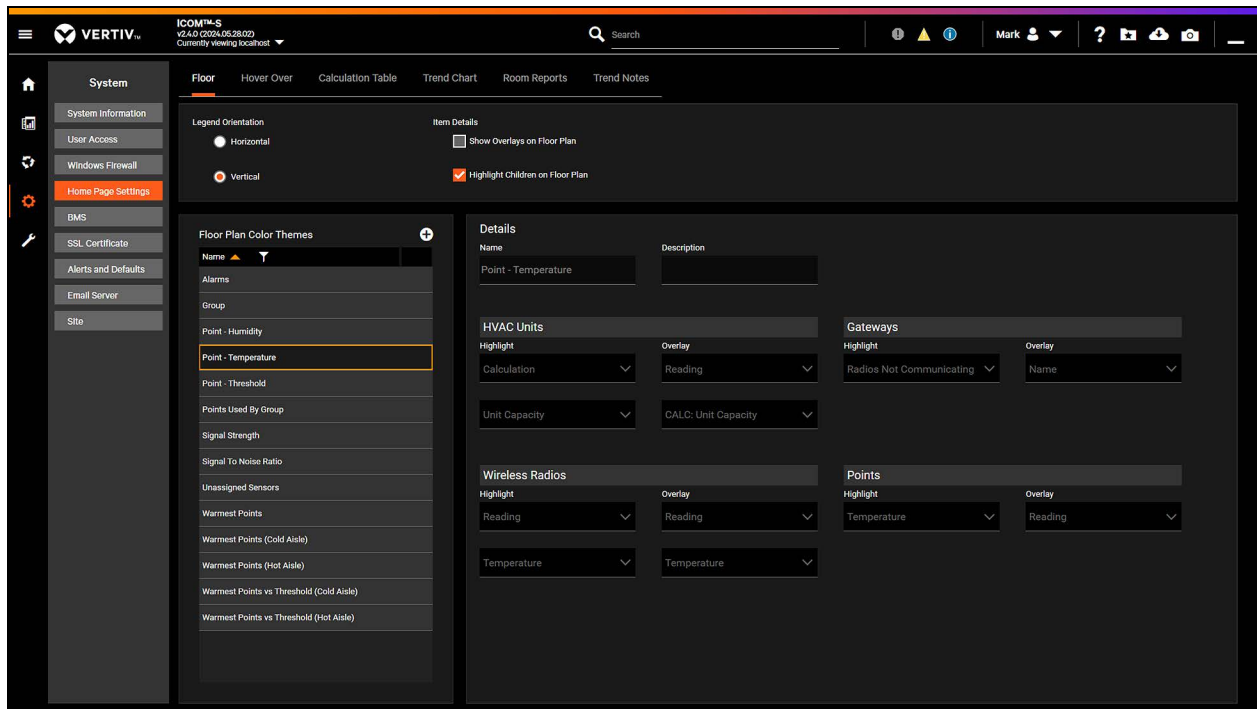

**NOTE:** The role of users can be edited in the [User Access](#) page. See [User Access](#) on page 90 for additional help.

The **Hover Over** tab allows users to define the points they want to view on the room view when they hover over a device. To add a point, first select which item you want to configure using the dropdown menu, then select the point on the Available side and drag it over to the Shown side. Save and enable the changes. To remove a point from the room view, drag the point from the Shown side back to the Available side.

The **Calculation Table** tab allows users to enable/disable calculations for BMS availability and specify what is shown in the upper left tiles on the Room, Group, Unit Views. To add a point, first select which category to configure using the dropdown menu, then select the point on the Not Enabled side and drag it over to the Enabled & Displayed side. Click Save to save and enable the changes. To remove a point, from the room view, drag the point from the Enabled & Displayed side back to the Not Enabled side. When the Site is selected, enabled calculations can either be displayed or not. There are four trends shown on the Main Site screen and four trends must be selected as Enabled and Displayed. The other enabled site calculations are visible on the **System > Site > Calculations** (tab).

The **Trend Chart** allows users to configure the graphs that are available on the site, room, device, point, or group view. First, select which page to configure using the dropdown menu, then enable or disable grid lines and select the default time range. Click **Save** to save and enable the changes.

The **Room Report** allows users to define the points they want to view on the room report view (Reporting icon on the floor plan tile). To add a point, first select which item you want to configure using the dropdown menu, then select it on the Available side and drag it over to the Shown side. Save and enable the changes. To remove a point from the room view, drag the point from the Shown side back to the Available side.



## 7.6.5 BMS

The **BMS Points** tab allows users to edit BMS points while in the Vertiv™ Liebert® iCOM™-S UI and edit and configure BMS settings.

Figure 7.27 BMS Menu

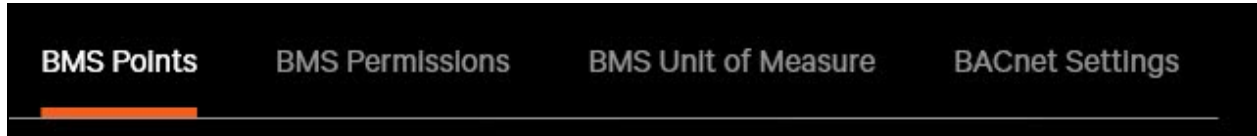

The **BMS Points** page allows users to edit points that were imported from the Points Configurator Application. To see how to import points from the point configurator. See [Points Configurator Menu Setting](#) on page 121. Once the points are added, users can modify applicable properties for each enabled protocol.

**NOTE: More properties can be modified using the Points Configurator program, including mass changes to Modbus registers or BACnet Instance IDs via Excel export/import process.**

The **BMS Permissions** page allows users to override individual point definitions to read only for both BACnet and Modbus.

**NOTE: If the BACnet Server IP change is saved and the client is having trouble connecting, try restarting the Liebert® iCOM™-S BMS Service in the Windows Services Panel.**

The **BMS Unit of Measure** page allows users to configure the units of measurements used for either BACnet or Modbus protocols. Select the drop down menu next to each parameter to see the options for unit of measurements.

**NOTE: BACnet settings and Modbus settings are different and changes to one menu will not change the other.**

**BACnet Settings** are configured in the **BACnet Settings** tab in the **BMS** section.

If there is more than one network interface card (NIC), the desired IP should be selected for the **BACnet Communications NIC**. Choose from the dropdown (predefined IP addresses) or type it in the **IP Address** field. It is recommended to select the IP from the dropdown list to avoid potential errors.

BACnet will only be available on one NIC at a time from Liebert® iCOM™-S.

The user can specify the BACnet Device Name, BACnet instance number of the Liebert® iCOM™-S Server, and BACnet port number the iCOM™-S Server will communicate on. Vertiv recommends leaving the port on 47808. The Retry timeout (ms) and retries value can be modified, but it is recommended to leave them at their default values. After changing anything on the BACnet Settings screen, press save and restart the Liebert® iCOM™-S Server. If the Liebert® iCOM™-S Server cannot be restarted, at a minimum, restart the Vertiv RDU BMS Service. The settings will not take effect until the Liebert® iCOM™-S Server or the Vertiv RDU BMS service is restarted.

To restart the Vertiv RDU BMS Service click on the Windows search icon in the tray, type in Services, and scroll down until the RDU BMS Service is found. Right-click on **Vertiv RDU BMS Service** and select **Restart**.

## 7.6.6 SSL Certificate

The SSL Certificate provides the ability for users to import their own trusted SSL certificate through desktop or Web UI.

Figure 7.28 User Interface Showing SSL Certificate

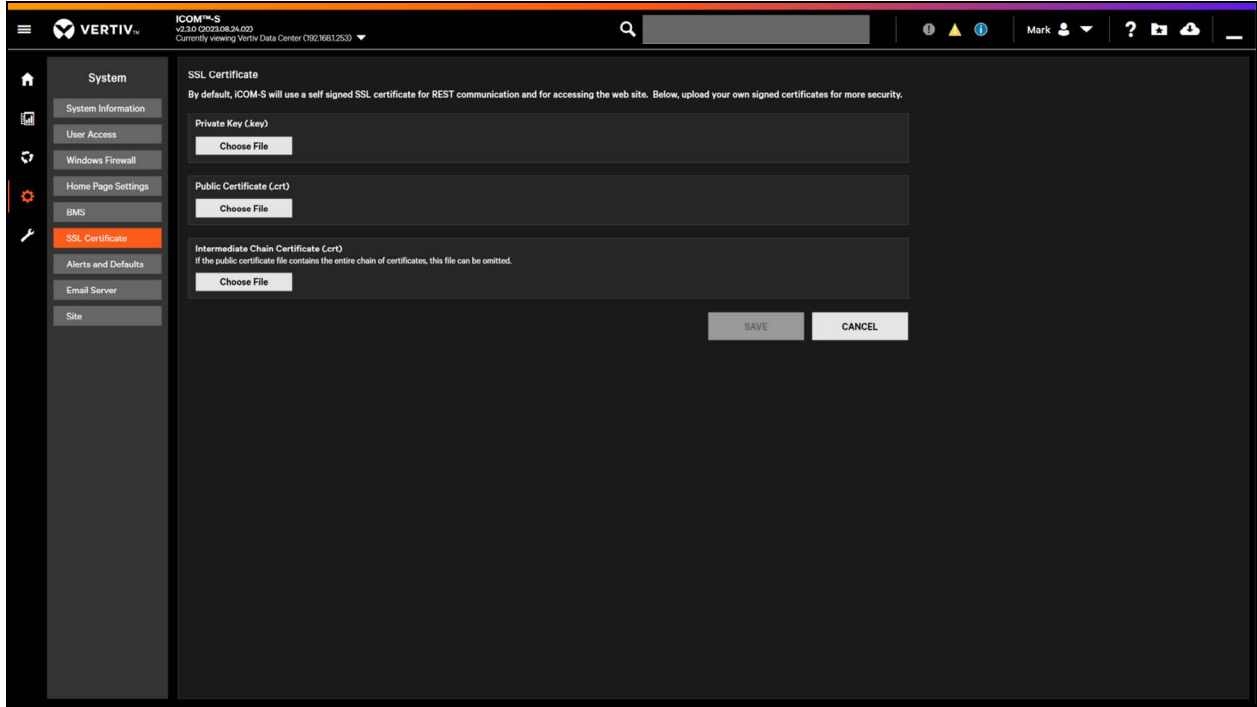

## 7.6.7 Alerts and Defaults

The **Alerts and Defaults** menu allows users to view and configure the Reading Threshold, Point Trending, and Alert Settings.

Figure 7.29 Alerts and Defaults Menu

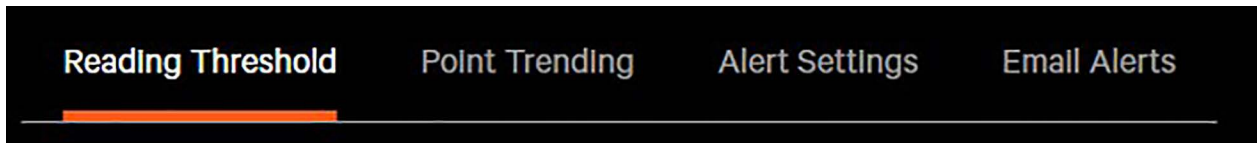

The **Reading Threshold** tab allows users to configure the threshold for multiple sensors at once. Select the threshold type, location, room, and control type. Select either changing the minimum value, the maximum value, or both. Then select **Save**.

The Vertiv™ Liebert® iCOM™-S will report to the user how many points are impacted by the change. This can be seen below the dropdown menus.

The **Point Trending** menu allows users to configure the logging rate of points and to better optimize the Liebert® iCOM™-S system. Users can set storage logic to be captured only when there is trending. Users will select the threshold type, locations, room, and control type. Select **Trending Off and On** then select **Save**.

If trending is turned **off**, charts in the home screen and reports will no longer show the trending data and instead just the instantaneous information. If trending is turned **on**, charts in the home screen and reports will have the trending data.

Most points are defaulted to have trending **on** and will shows the historical information in charts and reports.

The **Alert Settings** allow users to turn Critical, Warning, and Informational alert popups Off/On. This is only for popups and all the alerts will be visible in the alerts notification section on the main page.

**Figure 7.30 Alerts Settings**

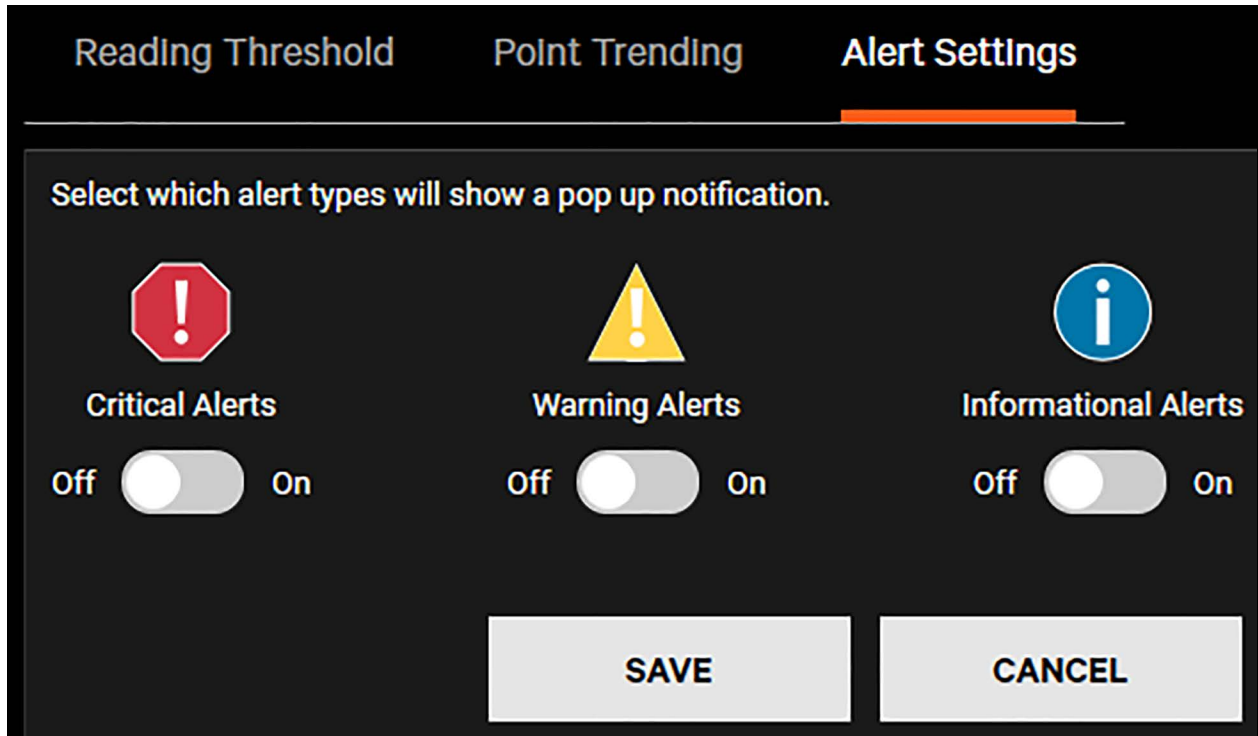

Email Alerts allows users to have alerts sent when a threshold is met for specific points. First an email server needs to be set up in the Email Server menu. Once set up, a user can select threshold type, filter the points using room, control type, row, and location. Then turn on “Email on Critical”, “Email on Warning”, or both. Select the gear to add the email recipients and hit “Save”. To turn off email alerts, filter the points you wish to turn off, move the slider to the left (Off), and select save.

Figure 7.31 Email Alerts

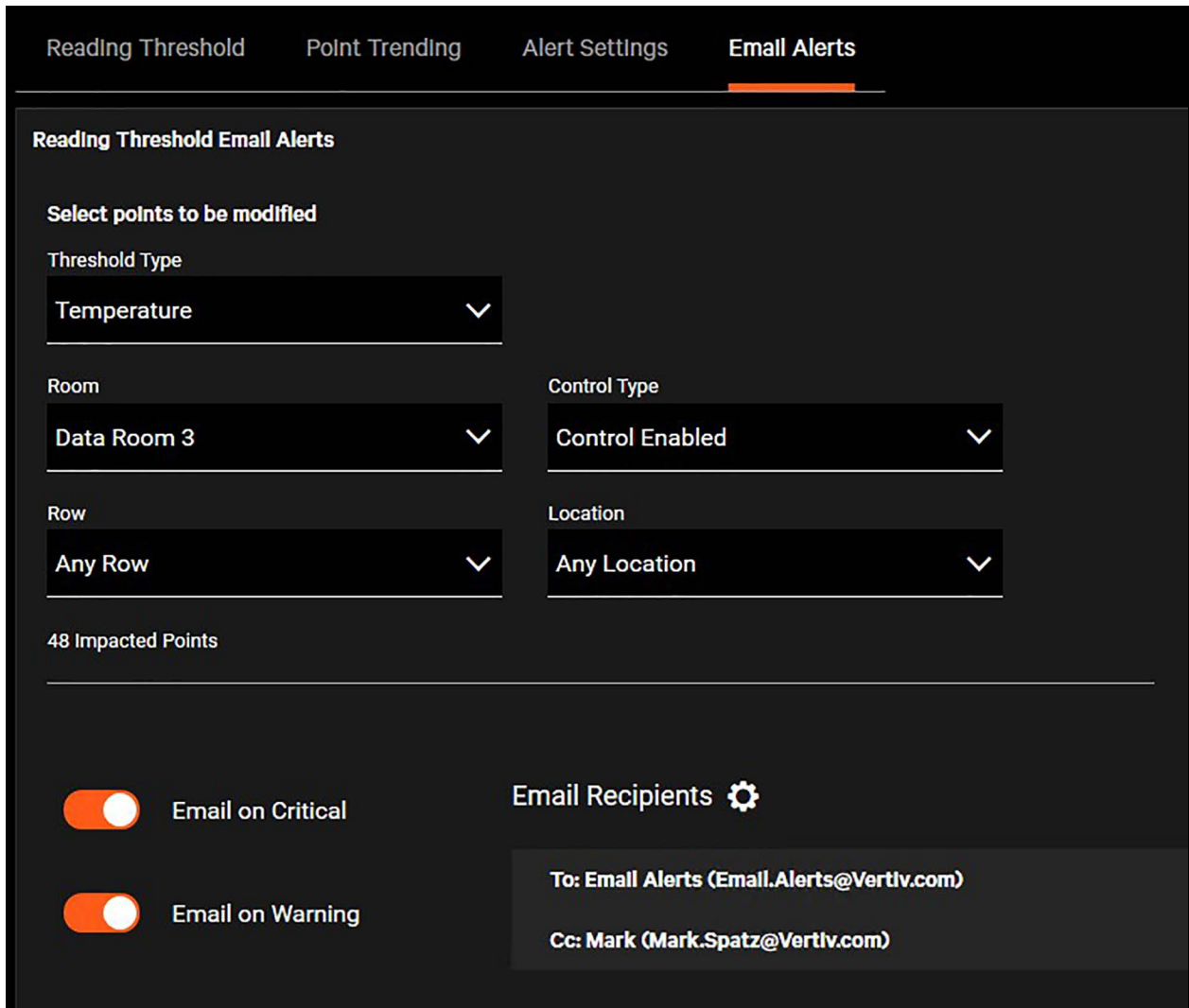

### 7.6.8 Email Server Configuration

In Vertiv™ Liebert® iCOM™-S, scheduled reports can be configured to be automatically delivered via email. To have Liebert® iCOM™-S send emails, the Email Server configuration needs setup.

**NOTE:** The Liebert® iCOM™-S needs to have network connectivity to an SMTP server for this functionality to work properly. Network administrators should be able to provide the required information below along with specific application instructions and credentials.

Options to configure the email server and send a test email to test the configuration are in the **Email Server Section** options to configure the email server and send a test email to verify the configuration.

You are required to fill in the following:

- SMTP Server
- Sender Name
- Sender Email
- Connection Type: TLS, SSL, or None
- Port: Select Use Standard Port, or Use Custom Port and type it in the custom port number.

**Figure 7.32 Email Server**

The screenshot shows the 'Email Server' configuration window. It has a dark background with white text and input fields. The fields are arranged in a grid-like fashion. On the left side, there are radio buttons for 'Connection' (TLS, SSL, None) and 'Port' (Use Standard Port, Use Custom Port). The 'Use Standard Port' option is selected, and the port number '0' is displayed. Below the 'Use Custom Port' option, there is a numeric input field with a minus sign on the left, '1,024' in the center, and a plus sign on the right. On the right side, there are input fields for 'Sender Email', 'Account', and 'Password'. The 'Password' field is masked with asterisks. A 'SEND TEST EMAIL' button is located to the right of the 'Sender Email' field. At the bottom of the window, there are 'SAVE' and 'CANCEL' buttons.

If the connection uses TLS or SSL, enable **Use Authentication** and complete the account and password fields.

After filling in the required fields, press **Save**.

It is recommended that after saving, put in an email address in the **Test Email Recipient** field and press **Send Test Email** to verify the saved settings.

## 7.6.9 Site

The **Site** page shows users all the calculations completed by the site and allows users to edit some details about the site. The **Details** window allows users to store the site name, description, address, and contact information along with the site coordinates. The **Calculations** window allows users to see specific site data that is calculated in the Vertiv™ Liebert® iCOM™-S. Clicking on a specific item will bring up the graph of that item. There is also the instantaneous value of the item next to the items name. Users can change the time of the graph with a dropdown menu.

Figure 7.33 Site Page

Name ▲ ▼	Reading ▼	
Site Capacity Used	80 %	⋮
Site Cold Aisle	77.3° F	⋮
Site Efficiency	1.21	⋮
Site Hot Aisle	77.3° F	⋮
Site HVAC Power	34.4 kW	⋮

Figure 7.34 Site Calculations

Details		Calculations	
Name ▲ ▼	Reading ▼		
Site CFM	90,000.0 CFM	⋮	
Site Cold Aisle	69.7° F	⋮	

**NOTE:** The Altitude coordinate is very important to set when first configuring the Vertiv™ Liebert® iCOM™-S. Refer to [Set System Altitude](#) on page 62 .

## 7.7 Service

The **Service** menu is where users can find Vertiv™ Liebert® iCOM™-S Software updates, backup/restore location, tools and diagnostics, low level settings, and support.

### 7.7.1 Vertiv™ Liebert® iCOM™-S Software

The Liebert® iCOM™-S Software page shows the version information, cloud software updates, and any local software updates. If the system is connected to the cloud, the Liebert® iCOM™-S will automatically inform the user of an update in the **Cloud Software Update**, or users can pull new software updates using **Check for Update**.

If users do not have the system connected to the cloud, the **Local Software Update** panel allows the user to complete a Safe Update or Update. Click the type of update you would like to complete and then select the file with the update. Contact your local Vertiv service provider to obtain the latest update.

**NOTE: Safe Update will generate backup files to be saved first before updating the system.**

## 7.7.2 Backup/Restore

The Backup/Restore page includes:

- Full system backup
- Full system restore
- Remote database backup

**Table 7.4 Backup/Restore Page Options**

Item	Description
Full System Backup	This exports a full system file, including monitored data and system configuration. When a manual Full System Backup is initiated, a password field will prompt the user to set a required password to protect the backup. By default on backups that are automatically run, the RDU Supervisor System password will be used. Automatic backups are run by default at 5:00 a.m. and saved (by default) to the C:\RDU\DatabaseBackup folder on the iCOM™-S.
Full System Restores	This is used to restore a full system backup from file.
Remote Database Backup	If the SQL Server is not located on the same server/panel with the iCOM™-S, configuration of the fields in this section is required for database backup or restore. Please refer to the instructions and requirements on the software UI regarding user access.

**NOTE: If the Remote database backup file location is left blank, the system will use the default local location.**

## 7.7.3 Tools and Diagnostics

The **Tools and Diagnostics** page provides access to external tools, including the Diagnostics Viewer, Room Editor, and Points Configurator. Clicking the icons below will open up their respective programs. The icons below the program shortcut icons allow the importing and exporting of the configuration files for the programs respectively.

Figure 7.35 Tools and Diagnostics Page

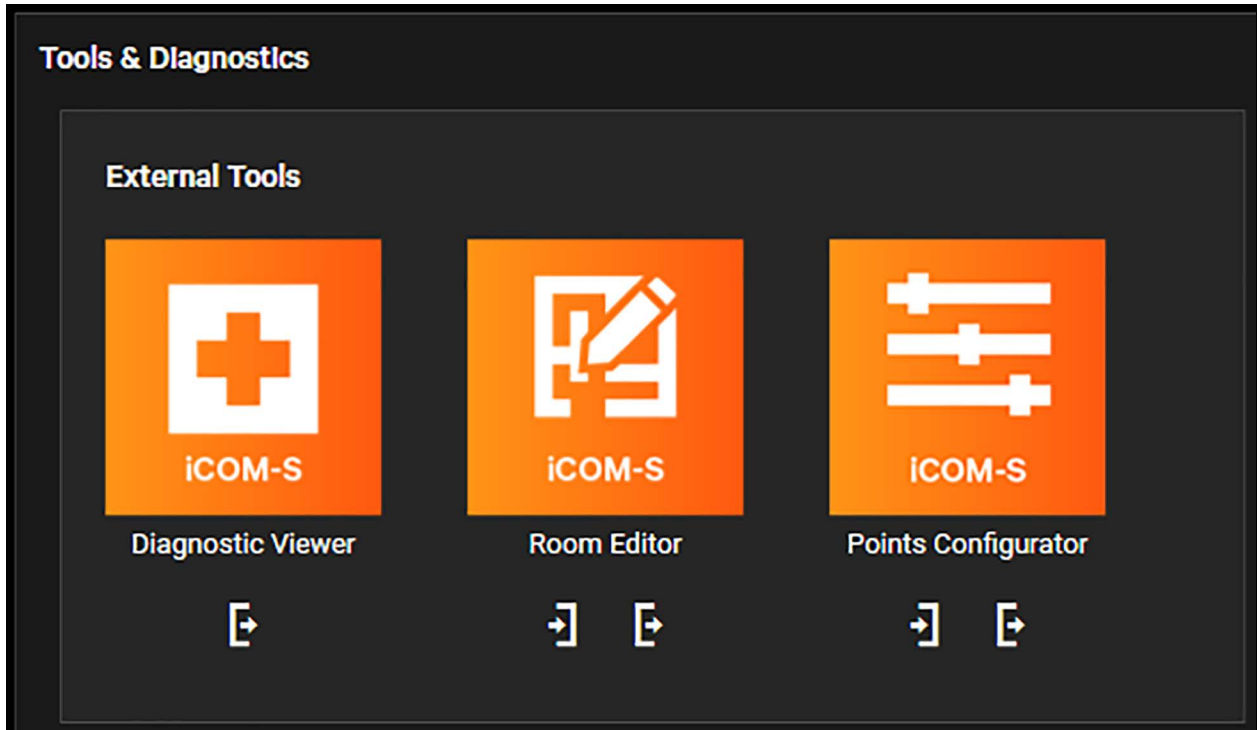

The **Diagnostics Viewer** tool allows users to export the Vertiv™ Liebert® iCOM™-S system to the Diagnostic Viewer program. See [Diagnostic Utility](#) on page 65 .

The **Room Editor** tool allows users to import and export the floor plans on the Liebert® iCOM™-S system to the Room Editor program. Refer to [Room Editor Program](#) on page 113 .

The **Points Configurator** tool allows users to import and export points on the Liebert® iCOM™-S system to the Points Configurator program. See [Points Configurator Program](#) on page 121 .

The **System** section allows low level service functionality and should not be used by the traditional user (especially Full System Wipe).

Users can refresh multiple points on the Liebert® iCOM™-S system by selecting the points that need to be refreshed and clicking **Refresh Selected Points**. The points available are All HVAC Unit Points, All Wireless Radio Points, All RDU Cluster Points, All Room Points. This menu is used when a new software version is released with new points and units are already on the Liebert® iCOM™-S.

**NOTE: If it's stated that a new version of Liebert® iCOM™-S software has additional unit points in it, this process will need to be used before the new points show up on the UI or become available for BMS communication.**



## 7.7.4 Low Level Setting

The **Low Level Settings** menu includes Configurations and Operation Logs.

Figure 7.36 Low Level Setting Menu

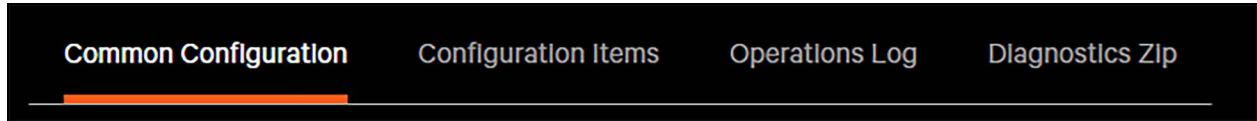

The **Common Configuration** tab allows users to configure parameters like Calculation Polling Intervals, Disk Alarms, Data Acquisition Polling Intervals, and Point Staleness. Select the interval desired to be modified using the buttons on the left. Set the new desired values and click Save. This list contains the most commonly used parameters.

The **Configuration Items** tab shows the complete list of configurable parameters. This list can be filtered by Category, Name, Value, Last Updated By, and Last Updated Date. Use the filter icon next to the list to filter. Click the refresh button on the bottom of the page to see the most updated values.

The **Operations Log** is the same view as the Operations Log tab in the diagnostic viewer. It allows users to see alert and error codes while still in the UI. See [Diagnostic Utility](#) on page 65.

## 7.7.5 Diagnostic Zip

The Diagnostic Zip is a way to pull information and logs from everywhere on the Vertiv™ Liebert® iCOM™-S system. Users can select a list of machine details and Liebert® iCOM™-S details to include in a report. A start and end date are used to select required information. This information can be saved in a folder or accessed and downloaded through the browser using <https://localhost:8100/Diagnostic>.

## 7.7.6 Support

The **Support** menu provides Version Information and System Information of the Vertiv™ Liebert® iCOM™-S. Customer Contact and Technical Support Contact information are also available on this page. The user can also enable/disable different Internet connected functionality (Diagnostics, Software Updates, License Updates, Configuration File Transfer).

## 7.8 Web UI

The web user interface has a similar menu structure and feature set as the full desktop Vertiv™ Liebert® iCOM™-S user interface. This section will go through the **Home, Reports, Connect & Control, System,** and **Service** menu available for web user interface.

### 7.8.1 Home

The **Home** menu is the top-level view for the Vertiv™ Liebert® iCOM™-S and displays the four site trend charts. Users can pull up the room view that includes the floor plan, calculations, and trending chart for calculations or unit measurements. Users cannot export any information on the web UI but can export all this information on the desktop UI.

Figure 7.37 Home Menu View

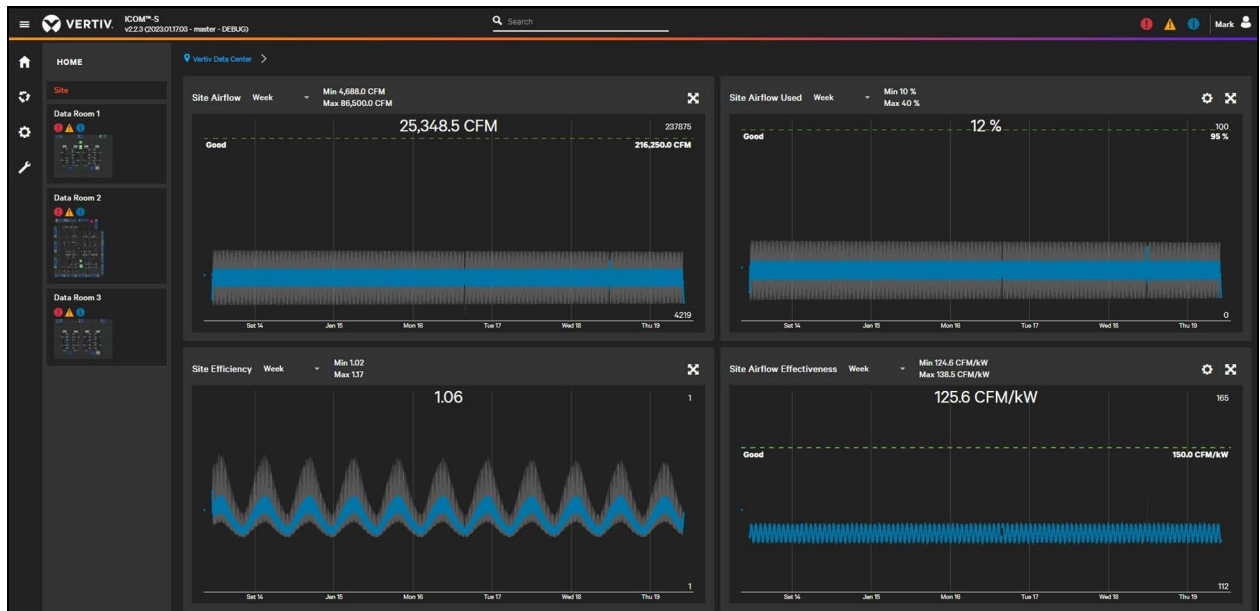

Figure 7.38 Room View

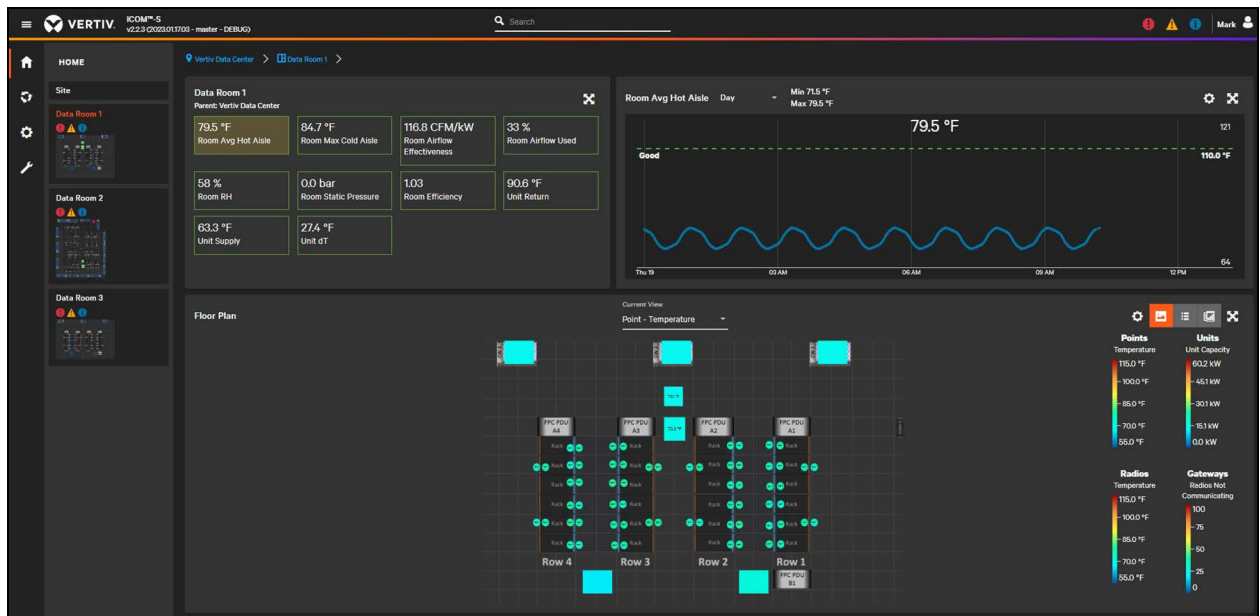
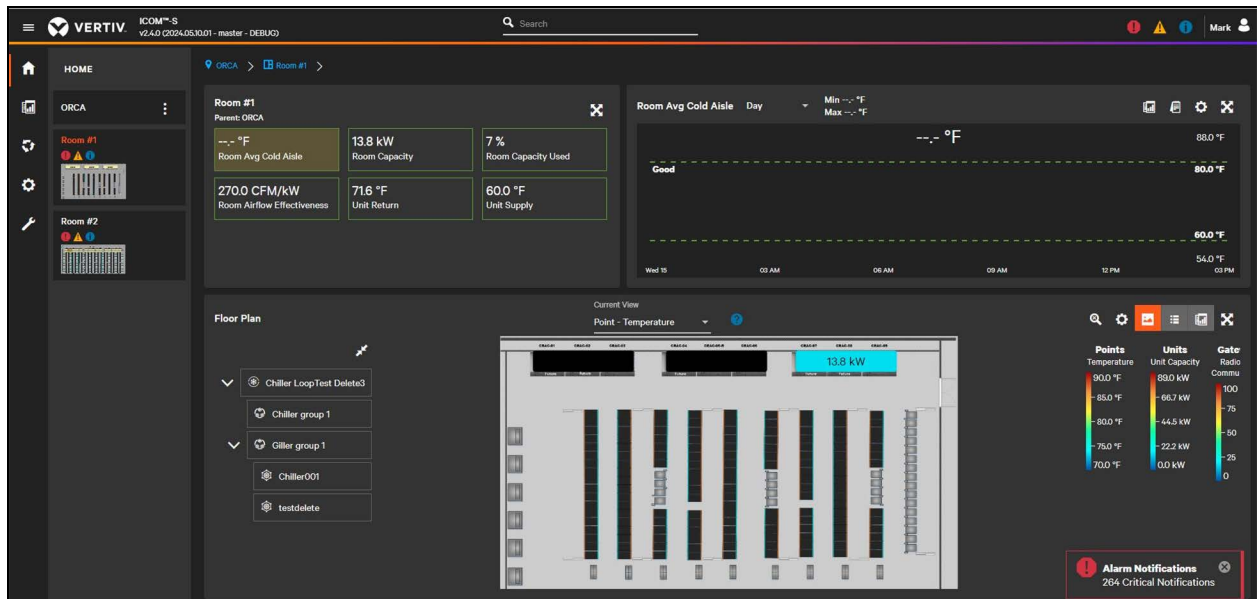

Figure 7.39 Room View with Chiller



The reporting menu is not available for the web user interface.

## 7.8.2 Reports

Selecting the Report menu will allow users to complete instantaneous reports, schedule reports to be automatically completed, or set a directory location on the for the reports to be saved.

Figure 7.40 Reports Menu

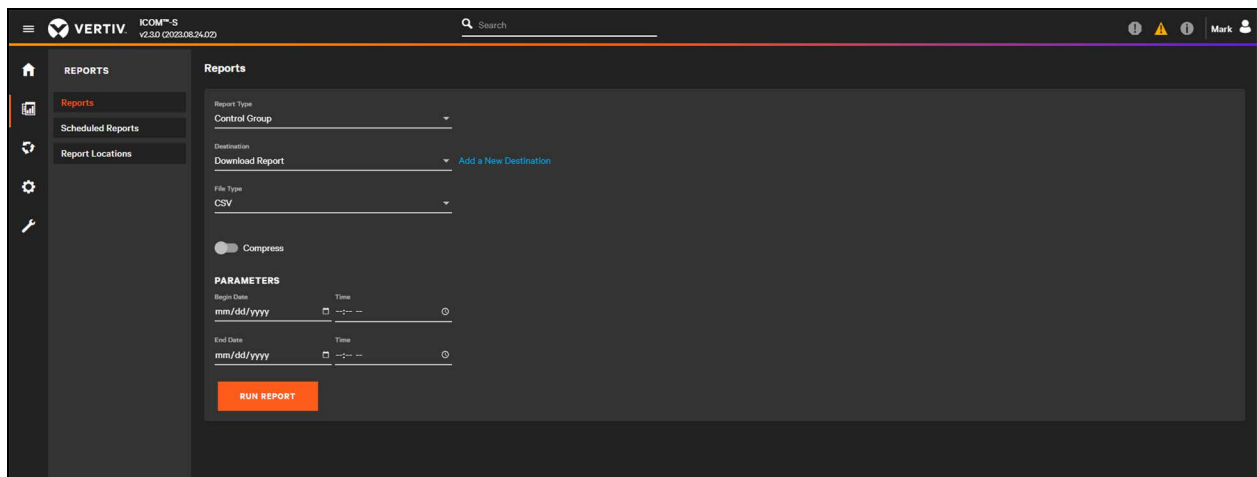

### 7.8.3 Connect and Control

The **Connect & Control** menu will allow users to view and configure groups, clusters, gateways, and units of the system. Users can add devices to the Vertiv™ Liebert® iCOM™-S that are connected to the network by using the (+) symbol. In the web UI, the cluster, wireless gateway, and Quick Start are not available.

Users can also import or export the room editor files from this location. This function on the **Topology** menu is only available on the web. To import or export room editor files on the Desktop, use the **Tools & Diagnostics** page in the **Service Menu**.

Figure 7.41 Connect & Control Menu

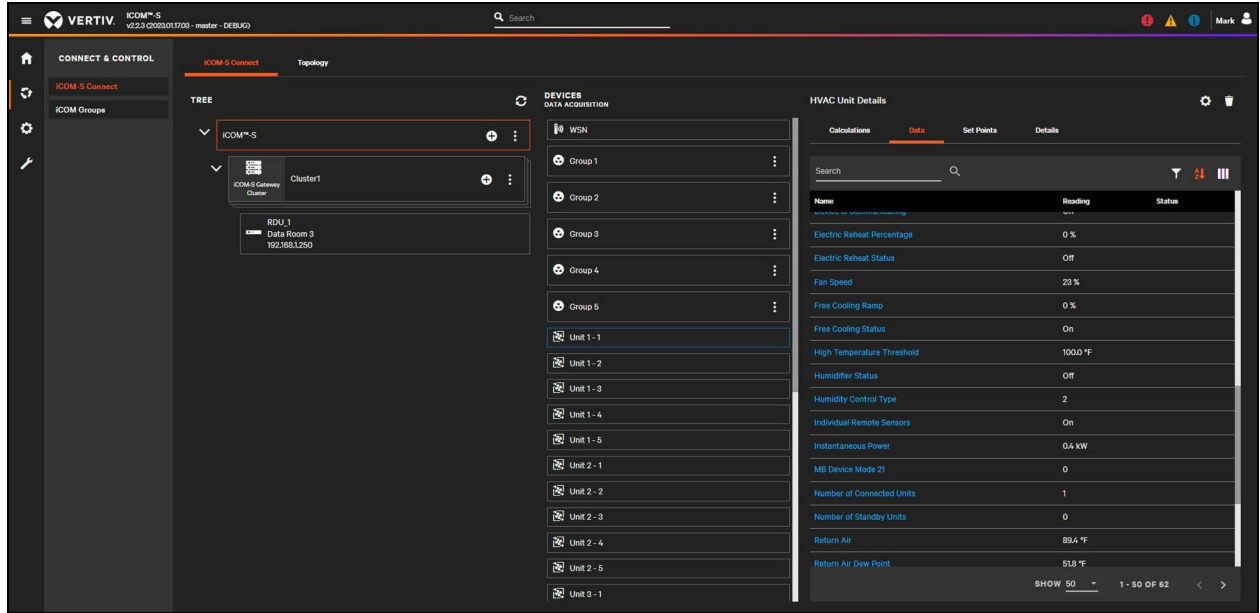

Figure 7.42 Connect & Control Topology Menu

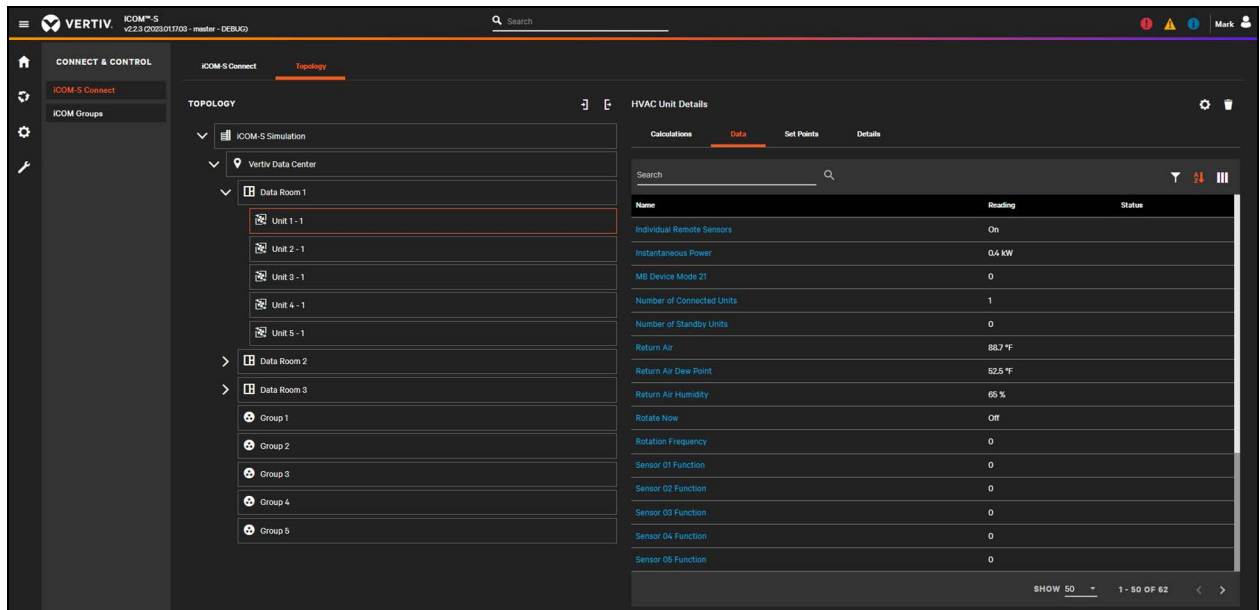

Figure 7.43 System Menu

The screenshot displays the 'SYSTEM' menu in the Vertiv iCOM-S web interface. The page is divided into several sections:

- System Information:** Includes Version Information (Services: 2023.1173, UI: 2023.1173), System Information (Job Number: SalesDemo\_3050, Model Number: SalesDemo\_3050, Manufacture Date: Jan 26, 2021, Panel ID: 10299), and Used Database Space (ICOM-S: 1% Remaining, Calculations: 63% Remaining, Points: 77% Remaining, Operations Log: 1% Remaining).
- System Counts:** A table showing various system metrics.
- Host:** Core Server IP Addresses: 192.168.1.253.
- Serial Number:** SalesDemo\_3050.
- Time & Locale:** English (United States), Thursday, January 19, 2023 10:19 AM.
- Licensing Information:** Licenses Used (RDU Gateways: 1/20, Wireless Control Points: 2/600, Wireless Gateways: 1/20, Thermal Units: 25/200, Power Units: 0/0, Max BMS Points Per Thermal Unit: 80, Support Option: Preferred).
- Licensed Features:** Demo, Data Only, Expanded Points, Monitoring & Trending, Wireless, Control, Commissioning.

## 7.8.4 Service

The **Service** menu provides Version Information and System information of the Vertiv™ Liebert® iCOM™-S. A Customer Contact and Technical Support Contact is also available on this page. The user can also enable/disable different Internet connected functionality (Diagnostics, Software Updates, License Updates, Configuration File Transfer). In the Web UI, Liebert® iCOM™-S Software, Backup/Restore, Tools & Diagnostics, and Low-Level Settings menus are not available.

Figure 7.44 Operations Log Menu

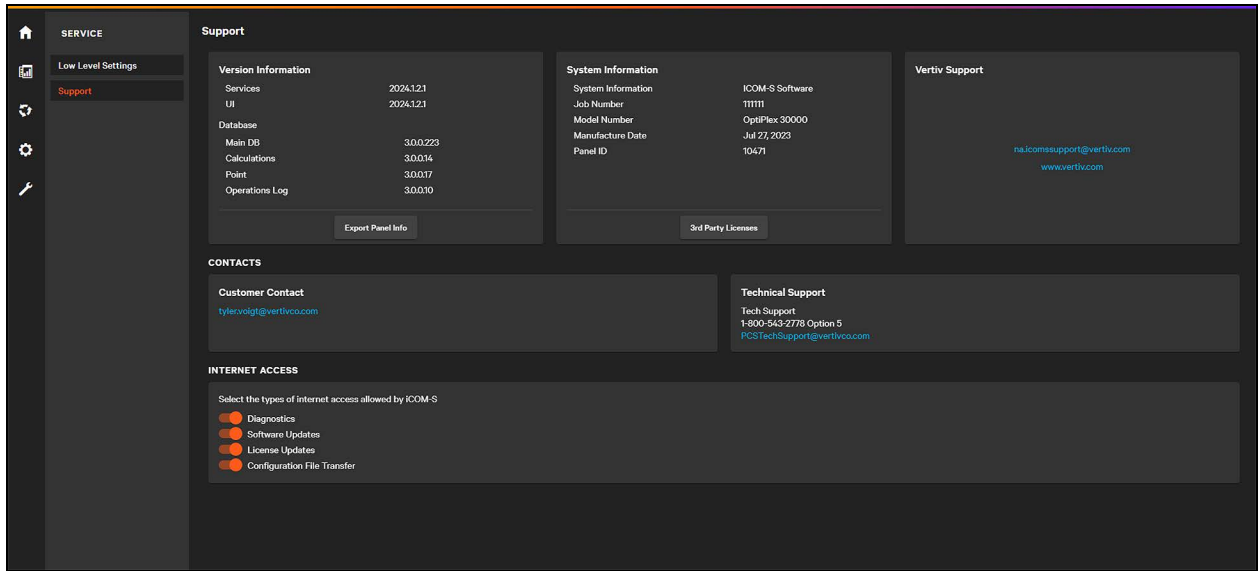

In the Web UI, if an invalid URL is entered the Vertiv™ Liebert® iCOM™-S will redirect the user to a Page Not Found screen. This screen allows users to select any menu icon to navigate to a new screen.

Figure 7.45 Diagnostic Zip

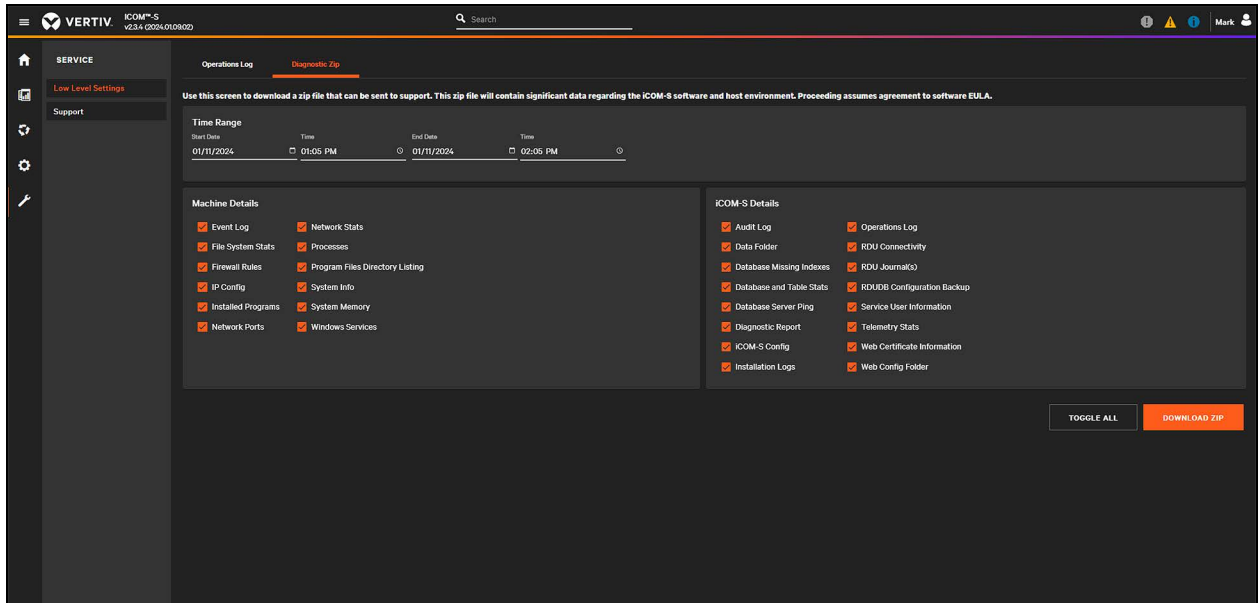

Figure 7.46 Support Menu

The screenshot displays the 'Support' menu in the Vertiv iCOM-S user interface. The interface is dark-themed and includes a sidebar on the left with a 'SERVICE' menu where 'Support' is selected. The main content area is organized into several sections:

- Support Section:**
  - Version Information:** A table showing version details for Services, UI, Database, Main DB, Calculations, Point, and Operations Log.
  - System Information:** A table showing system details like ICOM-S Software, Job Number, Model Number, Manufacture Date, and Panel ID.
  - Vertiv Support:** A section with contact information for technical support, including an email address and website.
- CONTACTS Section:**
  - Customer Contact:** Lists the name, phone number, and email of the customer contact.
  - Technical Support:** Lists the phone number and email for technical support.
- INTERNET ACCESS Section:**
  - A heading: "Select the types of Internet access allowed by iCOM-S".
  - A list of four access types, each with a radio button: Diagnostics, Software Updates, License Updates, and Configuration File Transfer.

This page intentionally left blank



## 8 Room Editor Program

Room Editor is a configuration application that combines field-supplied floor-plan images with the detailed system equipment configuration list exported from Vertiv™ Liebert® iCOM™-S to produce realistic room layout views that report monitoring data and conditions for all the configured equipment and areas.

### 8.1 Getting Started

1. When the Room Editor opens, click the **Open** button and select the Room Configuration file to edit (that was exported from the Vertiv™ Liebert® iCOM™-S).
2. Select the Room to edit in the drop down on the Room Selection screen, click **Next**
3. For the Room Background Image: If an image has already been selected, there is the option to use the existing or import a new one. If no image had been imported prior then the only option is to select a new image.
  - High-resolution (300 dpi) images of room and/or section layouts of the conditioned space that include room dimensions, raised floors, and placement of all equipment, wireless gateways, and sensors.
  - Accepted formats are .jpg, .bmp and .png.
  - .png files are recommended because they are vector based, relatively small, and preserve transparency.
  - The recommended maximum size is 3,000 x 3,000 pixels.
4. The Room Background Image Cropping screen allows the user to crop out a smaller area of the image for the actual background of the room to be used. Clicking the **Select All** hyperlink expands to maximum boundary of the image. Checking **Maintain Aspect Ratio** from original image will ensure your length and width of the image will remain the same as the existing image in the configuration file.

**NOTE: The cropped image requires one side to be at least 1,000 pixels.**

If no dimensions of the room are changing, click **Finish**.

If dimensions need to change, click **Next** to modify the dimensions, then click **Finish**.

**NOTE: If objects have been previously placed on the floor plan and later the room dimensions are changed to reflect a different aspect ratio, objects previously plotted will appear skewed.**

### 8.2 Home Menu Bar

The **Home** tab provides tools for placement and identification of the equipment on the floor plan.

The **Home Menu Bar** has seven groups of tools. Each tool is described in **Table 8.1** on page 115 below.

1. General
2. Export
3. Alignment
4. Group
5. Radio/Point Alignment
6. Room
7. Group Highlight

**Table 8.1 Home Menu Bar Tools**























Item	Description
<b>General</b>	
	Opens the room configuration file.
	Saves changes to the room configuration file.
	Undo changes.
	Redo changes.
<b>Export</b>	
	Exports the room image to PDF.
	Exports room layout and asset management inventory to PDF.
	Prints the room layout.
<b>Alignment</b>	
	Aligns the selected equipment to the left of the selection.
	Aligns the selected equipment to the bottom of the selection.
	Aligns the selected equipment to the top of the selection.
	Aligns the selected equipment to the right of the selection.
	Aligns the selected equipment along the center (vertical) line of the selection.
	Aligns the selected equipment along the middle (horizontal) line of the selection.
	Distributes the selected equipment evenly spaced across a horizontal selected

Table 8.1 Home Menu Bar Tools (continued)

Item	Description
	Distributes the selected equipment evenly spaced across a vertical selected.
<b>Group</b>	
	Groups together selected equipment.
	Ungroups previously grouped equipment.
<b>Radio/Point Alignment</b>	
	Sets the direction of the three sensor probes in relationship to the wireless radio when placed on the floor plan. The sensors can extend to the left, right, top, bottom or in a custom layout.
	Saves a custom sensor-probe layout. Drag each probe to the position you want, selected parent radio of the sensor probes, click Save New Layout, and give it a descriptive name.
	Deletes custom sensor probe layouts.
<b>Room</b>	
	Allows the user to change the current Room on the system being modified/viewed (with prompt for saving).
<b>Group Highlight</b>	
	This allows the user to select a group. When a group is selected a red border appears on the units in that group and the sensors associated to that group for purposes of control.

## 8.3 Setting Up a Room

It's important to realize the Room Editor doesn't add or remove equipment/devices from the system. The entire purpose is for visually setting up the system in a way such that associations are made. Placing the equipment provides the physical location for not only viewing dynamic icons on the floor plan in the software but for performing backend calculations and logic. For instance, selecting a row of sensors visually on the floor plan in Room Editor and changing the Location Type property to Cold Aisle will automatically include them into the proper Average Cold Aisle Temperature calculations for the room. Site changes will take effect after the configuration file is saved and imported back into Vertiv™ Liebert® iCOM™-S.

### 8.3.1 Placing Equipment

Equipment placed on the floor plan in Room Editor shows on the Vertiv™ Liebert® iCOM™-S display. If it is not placed on the floor plan, it will not appear in the Liebert® iCOM™-S views. All equipment in the toolbox is monitored and managed by Liebert® iCOM™-S. See **Figure 8.1** on the next page .

Figure 8.1 Equipment Monitoring

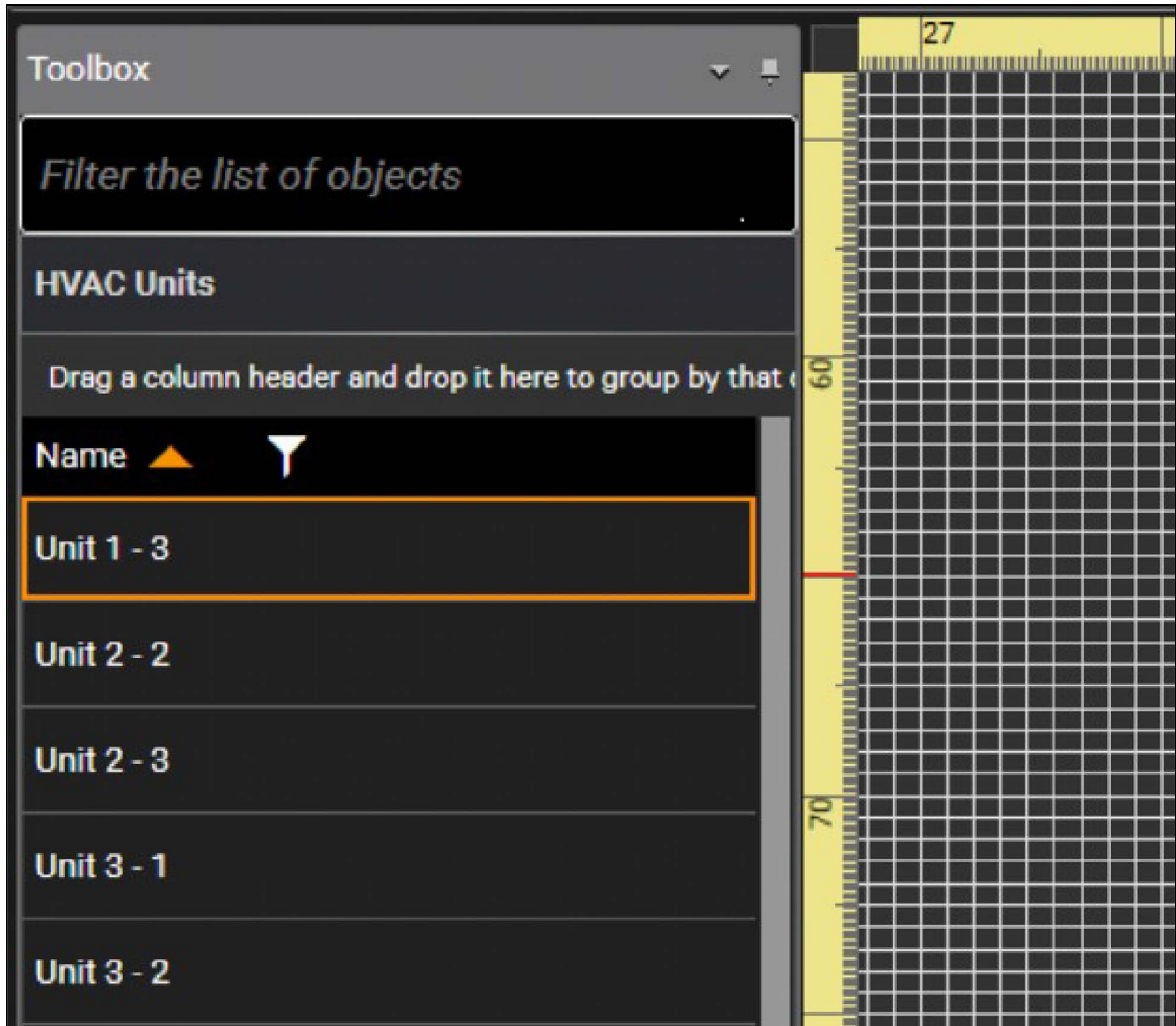

**To place and configure the floor plan:**

1. In the **Toolbox**, click a group to show the equipment.
2. Drag and drop equipment from the list to its appropriate location on the floor plan.
3. Adjust the equipment's orientation, location, and appearance using the Room Editor tools.

**NOTE:** Once placed, the equipment no longer appears in the toolbox to prevent duplicate placement. Deleting equipment from the floor plan puts it back into the Toolbox. For example, if a user wants to move a sensor from Room 1 to Room 2, they would select the sensor on Room 1 and delete it and then move it to the toolbox. Then the user would save the configuration and change the Room to Room 2 and drag and drop it to the correct location.

**NOTE:** Thermal management unit dimensions display proportional to the room size based on dimension data imported from Vertiv™ Liebert® iCOM™-S.

Use the re-size and rotation handles to adjust the equipment size and orientation. As you adjust, the properties panel displays the new size and location data. Clicking on the object and then editing the **Properties panel -> Location Information -> Dimension** fields directly can provide exact dimensions to be typed in. For changing dimensions of multiple objects at once, refer to [Editing Multiple Items at Once](#) below .

Use the alignment tools to efficiently lay out the room in neat lines and straight rows.

**NOTE: For fine placement, select the equipment, then press and hold CTRL while using the arrow keys to move the equipment in 1 in. increments. Press CTRL+SHIFT to move in 6 in. increments.**

Wireless radios and their sensor probes offer additional layout options. Use the corner rounding tools to change the shape of equipment objects for ease of identification. Use the color tools to help with the display and selection of the equipment in the Room Editor floor plan.

### 8.3.2 Editing Multiple Items at Once

**To select multiple items:**

1. In the Room Layout panel, select the equipment by by:
  - Using the cursor to draw a lasso around the equipment to select.
  - The lasso need only touch the boundary of an item to select it.
  - CTRL+click to select each item.

When multiple items are selected, click the **Multiple Item Edit** tab (found in the tab bar just above the Navigation window by default). This allows you to make mass changes to any position coordinate, dimension or corner radius of the selected objects.

If multiple sensors are selected, click the **Multiple Point Edit** tab (again found just above the Navigation window by default). Select 'Temperature Points' in the drop down. If wanting to set all of these temperature sensors to be Cold Aisle, Group Controlling (for group 1) with a min/max threshold of 65/85 this could be done with one selection. Check Location Type and select Cold Aisle. Check Add/Remove Groups and check the Group 1 until it shows a check (this is a tri-state check box for enabled/disabled/unchanged). Check the Set Reading Thresholds and then type in 65 in the low and 85 in the high and then push the **Save** button.

## 8.4 View Tab

The View tools let you adjust the visibility settings of equipment in the room-layout panel of Room Editor. You can show/hide and adjust transparency by equipment type. You can also show/hide and adjust the size of the grid in the room-layout panel.

If you hide all equipment except that which you want to modify, you can lasso the entire floor plan, and easily modify the common properties of the selected equipment.

**To adjust the Room Layout panel view:**

1. Select the **View** tab.
2. Click to check the equipment or grid to display. Unchecking hides the items on the floor plan.
3. In the **Show** section, use / to adjust the transparency of the equipment.
4. In the **Grid** section, use / to adjust the scale represented by the grid squares.

## 8.5 Colors Tab

The Color tools let you customize the default and highlight color of equipment in the Room Layout panel of Room Editor. The default color is the unselected color of the equipment. The highlight color displays when the equipment, parent and children if applicable, is selected on the floor plan. Where this is really helpful is understanding which wired sensors are physically connected to which units. Selecting a unit on the floor plan highlights it's children sensors in the Toolbox and vice versa.

**NOTE: When the Room configuration file is saved in the Room Editor, this is when the room thumbnail images are created for the main Vertiv™ Liebert® iCOM™-S UI navigation. Any currently displayed colors (selected or not) will be shown on the thumbnail for the room.**

**To customize equipment colors:**

1. Select the **Colors** tab.
2. Click the color box for the equipment to change. A color palette opens.
3. Click the color to use.

## 8.6 Exporting to Vertiv™ Liebert® iCOM™-S

To export the new file to the Liebert® iCOM™-S, save the file on the top left of the **Home Menu > General Section** page. Navigate back to the Liebert® iCOM™-S main interface and open the **Service** window and the **Tool & Diagnostics**. Click on the import button under room editor and select the file you just saved.

## 9 BMS Integration

Careful consideration should be given to BMS Integration, specifically in the configuration of the points schema. Proper research should be conducted to know the full site build out once completed. If this is not given consideration prior to beginning points configuration, it is possible to run out of available points registers before the site buildout is completed. Points schema should be planned and approved by the site stakeholders prior to beginning the Vertiv™ Liebert® iCOM™-S installation.

Consideration should also be given to CRAC naming conventions when importing units in to Liebert® iCOM™-S. This is not such an issue with small sites as all points are typically configured manually. On larger sites with thousands of points it is advantageous to perform a points export from Liebert® iCOM™-S, manipulate the points, and import them back in using the Points Wizard. The points values are modified using an Excel spreadsheet. This spreadsheet is sorted and filtered based on CRAC and ROOM naming. Consider the following examples:

- CRACs named **CRAC1 – CRAC20** will sort in Excel as **CRAC1, CRAC10, CRAC2, CRAC20...**
- CRACs named **CRAC01 – CRAC20** will sort in Excel as **CRAC01, CRAC02, CRAC03...**

**IMPORTANT! Always use the same number of digits for the first CRAC as there will be in the final site CRAC.**

Do not change the naming of CRACs for special designations such as R-CRAC-11 for reserve. Place the R at the end for proper sorting: CRAC-11-R.

Never use \ or / in naming conventions. The Excel lookup function uses these characters as string separations.

Always be consistent in room and CRAC naming conventions. Continue through all future buildouts in the same naming schema that the site started with.

### 9.1 Points Schema Modbus

Modbus points have an available bank from 000001 to 465535 (max register of 65,535 with Read Function code of 4). Typically, the six-digit Modbus tag is made up of the following elements:

- 1 digit = Read Function Code
  - 0 = Digital Output, 1 = Digital Input, 3 = Analog Input, 4 = Analog Output
- 1 digit = Room ID – available rooms are 0-9
- 2 digits = Modbus Point ID - available IDs are 00-99
- 2 digits = CRAC ID – available IDs are 00-99

To maximize the total number of points registers available, Vertiv recommends using the following schema:

- Register Digit 1 = Read Function Code (Analog/Digital)
- Register Digit 2 = Room/Data Hall ID
- Register Digits 3-4 = Space ID (Data Hall/CRAC ID/Rack Containment Space)
- Register Digits 5-6 = Point ID

It should be noted that Point IDs can be duplicated without overlap if different Read Function Codes are used.

## 9.2 Points Schema BACnet

BACnet points are configured automatically by the Vertiv™ Liebert® iCOM™-S system once BACnet for that individual point is enabled. BACnet points can be modified by first exporting using the Points Configuration editor and opening in Excel. There is no limit on the amount of BACnet points that can be enabled other than Liebert® iCOM™-S system resources.











## 10 Points Configurator Program

The Points Configurator combines all the BMS configuration steps that are present in Vertiv™ Liebert® iCOM™-S, and lets you configure and enabled multiple points at one time. The Configurator provides naming and numbering templates and a Wizard that applies the settings and templates.

### 10.1 Points Configurator Menu Setting

[Points Configurator Menu Settings](#) below provides the options for the Point Configurator menu setting.

**Table 10.1 Points Configurator Menu Settings**

Item	Description
<b>Home Tab</b>	
	Opens the point configuration file exported from iCOM™-S.
	Saves the configured points file for import into iCOM™-S.
	Opens the point configuration wizard. See <a href="#">Using the Wizard to Configure Points</a> on the next page
	Opens the Export Points List. See <a href="#">Exporting the Points List for a BMS</a> on page 123 .
	Export configured points into a .csv file.
<b>Setting Tab</b>	
 Naming	Opens the Naming Template Tool that allows the user to configure custom templates used for default naming of Modbus Tags or BACnet Instance Names.
 Renumbering	Opens the Block Numbering tool that allows the user to specify blocks of points to be used for specific objects.
 Import	Allows the user to import a previously saved/exported Naming Template list for easier duplication.
 Export	Allows the user to export a list of templates for use on another iCOM™-S system.

## 10.2 Using the Wizard to Configure Points

The Wizard lets you configure multiple points in a point-configuration file at one time. You can select the points by sensor, calculation, device, naming template, and several other options.



Figure 10.1 BMS Point Wizard

**BMS Points Wizard**

**Point Selection**  
Select the points in the left grid and move them to the right grid to enable/disable them.

**Available Points**  
Drag a column header and drop it here to group by that column

Name	Parent Type	Parent Name	Room Name	Already Enabled	Point
ATS Line State	HVAC Unit	Unit 3 - 4	Data Room 2	<input type="checkbox"/>	
ATS Line State	HVAC Unit	Unit 4 - 4	Data Room 2	<input type="checkbox"/>	
ATS Line State	HVAC Unit	Unit 1 - 4	Data Room 2	<input type="checkbox"/>	
ATS Line State	HVAC Unit	Unit 5 - 4	Data Room 2	<input type="checkbox"/>	
AutoSet Enable	HVAC Unit	Unit 2 - 1	Data Room 1	<input type="checkbox"/>	
AutoSet Enable	HVAC Unit	Unit 3 - 1	Data Room 1	<input type="checkbox"/>	
AutoSet Enable	HVAC Unit	Unit 4 - 1	Data Room 1	<input type="checkbox"/>	
AutoSet Enable	HVAC Unit	Unit 5 - 1	Data Room 1	<input type="checkbox"/>	
AutoSet Enable	HVAC Unit	Unit 2 - 2	Data Room 2	<input type="checkbox"/>	
AutoSet Enable	HVAC Unit	Unit 3 - 2	Data Room 2	<input type="checkbox"/>	
AutoSet Enable	HVAC Unit	Unit 4 - 2	Data Room 2	<input type="checkbox"/>	
AutoSet Enable	HVAC Unit	Unit 5 - 2	Data Room 2	<input type="checkbox"/>	
AutoSet Enable	HVAC Unit	Unit 1 - 2	Data Room 2	<input type="checkbox"/>	
AutoSet Enable	HVAC Unit	Unit 3 - 3	Data Room 2	<input type="checkbox"/>	
AutoSet Enable	HVAC Unit	Unit 5 - 3	Data Room 2	<input type="checkbox"/>	
AutoSet Enable	HVAC Unit	Unit 1 - 3	Data Room 2	<input type="checkbox"/>	
AutoSet Enable	HVAC Unit	Unit 2 - 3	Data Room 2	<input type="checkbox"/>	

109 Available Points

**Points To Be Modified**  
Drag a column header and drop it here to group by that column

Name	Parent Type	Parent Name	Room Name	Already Enabled	Point Typ
ATS Line State	HVAC Unit	Unit 4 - 3	Data Room 2	<input type="checkbox"/>	
ATS Line State	HVAC Unit	Unit 2 - 4	Data Room 2	<input type="checkbox"/>	
AutoSet Enable	HVAC Unit	Unit 1 - 1	Data Room 1	<input type="checkbox"/>	
C1 Freeze Protection Alarm Enable	HVAC Unit	Unit 3 - 4	Data Room 2	<input type="checkbox"/>	
Cascade Fire Alarm Reset Enabled	HVAC Unit	Unit 2 - 2	Data Room 2	<input type="checkbox"/>	
Cascade Fire Alarm Reset Enabled	HVAC Unit	Unit 2 - 4	Data Room 2	<input type="checkbox"/>	
Cascade Fire Alarm Reset Enabled	HVAC Unit	Unit 5 - 5	Data Room 3	<input type="checkbox"/>	
Cascade Fire Alarm Reset Interval	HVAC Unit	Unit 4 - 2	Data Room 2	<input type="checkbox"/>	
Cascade Fire Alarm Reset Interval	HVAC Unit	Unit 4 - 3	Data Room 2	<input type="checkbox"/>	
Cascade Fire Alarm Reset Interval	HVAC Unit	Unit 5 - 4	Data Room 2	<input type="checkbox"/>	
Cascade Fire Alarm Reset Interval	HVAC Unit	Unit 1 - 5	Data Room 3	<input type="checkbox"/>	
ATS Line State	HVAC Unit	Unit 2 - 5	Data Room 3	<input type="checkbox"/>	
ATS Line State	HVAC Unit	Unit 3 - 5	Data Room 3	<input type="checkbox"/>	
ATS Line State	HVAC Unit	Unit 4 - 5	Data Room 3	<input type="checkbox"/>	
ATS Line State	HVAC Unit	Unit 1 - 5	Data Room 3	<input type="checkbox"/>	
ATS Line State	HVAC Unit	Unit 5 - 5	Data Room 3	<input type="checkbox"/>	

16 Selected Points

< BACK    NEXT >    CANCEL

### To configure multiple points:

1. On the **Home** tab, click the **Wizard** icon.
2. Click **Next**, then select the type of points to enable.
  - By PointType: sensors across the whole system
  - By Calculation Type: calculations available
  - By Device or Data Level: devices (units/sensors/radios) or information level.
  - Modify Current Points: currently enabled points.
  - Change Modbus Template: change the naming templates for all Modbus-enabled points to a different naming template.
  - Change BACnet Template: change the naming templates for all BACnet-enabled points to a different naming template.
  - Renumber: Renumber all instance IDs for BACnet or Modbus register address if using a block numbering scheme, see Renumbering Instance IDs and Registers below, before using this option.

3. Click **Next** and use the selection boxes to select the specific types or groups of data points and click **Next** again. The Point Selection dialog opens listing all the data points that match the criteria selected.
4. Select the points to configure individually by selecting a point in Available Points. Hold the CTRL key to select multiple points. Click the single right arrow to move the selected points to **Points to be Modified**. Alternately, click the double arrow to move all points from **Available Points** to **Points to be Modified**.
5. Click **Next**, and select the action to perform on the points:
  - For BACnet and Modbus protocols, you can enable or disable the selected points, or choose not to modify them.
  - You can also enable or disable the Lock status of the points or choose not to modify.

**NOTE: Locking prevents any modification to the configured registers from this point forward. It locks these settings as soon as the wizard configuration is finished.**

6. Click **Next**. The Changes Summary dialog opens showing the actions selected and listing the point sources affected.
7. Click **Finish**. The configuration/modification is complete, and the Home tab points list displays to review the updated settings.

## 10.3 Exporting the Points List for a BMS

In addition to creating a point configuration file for the Vertiv™ Liebert® iCOM™-S the same information must be communicated to the BMS. The Export option on the Points Configurator creates a .csv file in the appropriate third-party format for import into the BMS client.

The Export Files List lets you drag data points into the column format, organize the columns, and stack values. It also lets you export the entire points list, or select by points by device or component, and if available, apply BMS client specific format to the output.

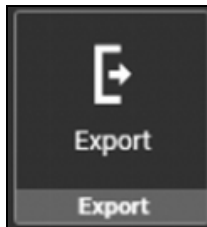

**To configure a points list for export to a BMS:**

1. On the **Home** tab, click **Export**. The Export Files list opens.
2. Select the protocol, then drag the data points to export into the column sorting area and arrange in the format needed for the output file.
3. Select export to single or multiple files.
4. In Items to **Export**, select device/component data points to export by highlighting the device.
5. Click **Save**, browse to the save location, enter a descriptive name for the file, and click Save. The .csv file is ready to provide to the BMS integrator.

**NOTE: If connecting the Liebert® iCOM™-S to a Kepware OPC Server via Modbus, select the protocol = Modbus and then for the Predefined Export Format dropdown, select the Kepware - Modbus option. This will convert and format the export list to align with a direct import for that system for easier BMS client mapping.**

## 10.4 Lists of Points Available

**NOTE:** Points will only be available for configuration if the sensor is available and providing data. When exporting points, have all cooling units to be configured powered and pushing air (cooling not required).

**Table 10.2 Site Points Available**

Site Capacity Used	Site Hot Aisle	High Temperature Alarm
Site Cold Aisle	Site HVAC Power	Wireless Sensor Infrastructure Alarm

**Table 10.3 Room Points Available**

Room Avg Cold Aisle	Room Efficiency	Unit Supply
Room Capacity	Unit dT	High Temperature Alarm
Room CFM Used	Unit Return	Wireless Sensor Infrastructure Alarm

**Table 10.4 Unit Points Available**

Unit Capacity	EEV Unspecified Alarm	Number of Standby Unit
Unit CFM Alarm s	EEV 1-4 Driver Failure	PB 1-4 Summary
Unit dT	EEV 1-4 Motor Error Alarm	Pump Failure Alarm
1A-10A	EEV 1-4 Power Failure Alarm	Remote Air Setpoint
Airflow Calibration	EEV 1-4 Unspecified Alarm	Return Air
C.P. High H2O Alarm	Electric Reheat Percentage	Return Air Dew Point
CAN EEV1-4 Comm Error Alarm	Electric Reheat Status	Return Air Humidity
Circuit 1 High Pressure Alarm	Fan Control Sensor Type	Room Sensor Failure Alarm
Circuit 1 Low Pressure Alarm	Fan Control Type	Rotate at Hour
Circuit 2 High Pressure Alarm	Fan Dead band	Rotate at Minute
Circuit 2 Low Pressure Alarm	Fan Integration Time	Rotate By
Clogged Filter Alarm	Fan Proportional Band	Rotate Every
Common Alarm Status	Fan Speed	Rotate Now
Compressor 1 Over Temp Alarm	Fan Temperature Compensation Limit Alarm	Rotation Frequency
Compressor 1 Overload Alarm	Free Cooling Status	Sensor 1-10 Function
Compressor 1 Short Cycle Alarm	General Compressor Overload Alarm	Smoke Detection Alarm
Compressor 1A Overload Alarm	General Fan Failure Alarm	Specific Unit Status
Compressor 1B Overload Alarm	High Return Air Dew Point Alarm	Standby Units on Alarm
Compressor 2 Over Temp Alarm	High Room Humidity Alarm	Start Standby Units by High Temp
Compressor 2 Overload Alarm	High Room Return Air Temp Alarm	Static Pressure Units
Compressor 2 Short Cycle Alarm	High Static Pressure Alarm	Supply Air
Compressor 2A Overload Alarm	High Supply Temperature Threshold	Supply Air Humidity

**Table 10.4 Unit Points Available (continued)**

Compressor 2B Overload Alarm	Humidity Control Type	Supply Air Setpoint
Compressor 3A Overload Alarm	Individual Remote Sensors	Supply Sensor Failure Alarm
Compressor 3B Overload Alarm	Instantaneous Power	Teamwork Mode
Compressor 4A Overload Alarm	Lead Lag Overlap Timer	Temperature Control Sensor Type
Compressor 4B Overload Alarm	Loss Of Air Alarm	Temperature Control Type
Condenser 1 Communication Lost Alarm	Loss of Power Alarm	Temperature Dead band
Condenser 2 Communication Lost Alarm	Low Return Air Dew Point Alarm	Temperature Integration Time
Cooling Percentage	Low Room Humidity Alarm	Temperature Proportional Band
Cooling Status	Low Room Return Air Temp Alarm	Unit Network Failure Alarm
Current System Static Pressure	Low Static Pressure Alarm	Unit Remote Sensors
Current Unit Static Pressure	Low Supply Temperature Alarm	Unit Remote Sensors in AVG
Dehumidifier Status	Maximum Fan speed	Unit Status
Device is communicating	Minimum Fan speed	Water Detection Alarm
EC Fan Failure Alarm	Number of connected Units	

**Table 10.5 Group Points Available**

Group Dew Point	Group Static Pressure	Unit Supply
Group RH	Unit Return	

**Table 10.6 Chiller Points Available**

Actual Cooling Capacity	C2 - Fan 3 Status	EEV 1 Driver - Generic Alarm
Ambient Air Temperature	C2 - Fan 4 Speed Feedback	EEV 2 Driver - Communication Failure
Ambient Temperature Probe 2 Failure	C2 - Fan 4 Status	EEV 2 Driver - Generic Alarm
Ambient Temperature Probe Failure	C2 - Fan 5 Speed Feedback	EEV 3 Driver - Communication Failure
Auxiliary Power Failure	C2 - Fan 5 Status	EEV 3 Driver - Generic Alarm
Bypass Valve Opening Request	C2 - Fan 6 Speed Feedback	EEV 4 Driver - Communication Failure
C1 - Compressor Capacity	C2 - Fan 6 Status	EEV 4 Driver - Generic Alarm
C1 - Compressor Status	C2 - Fan 7 Speed Feedback	Energy Meter - Current L1
C1 - Condenser Fans Control	C2 - Fan 7 Status	Energy Meter - Current L2
C1 - Condensing Pressure	C2 - Fan 8 Speed Feedback	Energy Meter - Current L3
C1 - Condensing SP	C2 - Fan 8 Status	Evap Pumps - Pump 1 Alarm Code
C1 - Condensing Temperature	C2 - Fan 9 Speed Feedback	Evap Pumps - Pump 1 Request
C1 - Control Mode	C2 - Fan 9 Status	Evap Pumps - Pump 1 Speed Feedback
C1 - EEV Control	C2 - Fan Speed Request %	Evap Pumps - Pump 1 Status
C1 - EEV Opening Position	C2 - Fan Speed Request rpm	Evap Pumps - Pump 2 Alarm Code
C1 - Fan 1 Speed Feedback	C2 - Fans Speed	Evap Pumps - Pump 2 Request
C1 - Fan 1 Status	C2 - HP Switch	Evap Pumps - Pump 2 Speed Feedback

**Table 10.6 Chiller Points Available (continued)**

C1 - Fan 10 Speed Feedback	C2 - LCC Status	Evap Pumps - Pump 2 Status
C1 - Fan 10 Status	C2 - Liquid Temperature	Evaporator Inlet
C1 - Fan 2 Speed Feedback	C2 - LP Switch	Evaporator Inlet Water Temperature
C1 - Fan 2 Status	C2 - Protection Threshold	Evaporator Outlet
C1 - Fan 3 Speed Feedback	C2 - Speed	Evaporator Outlet Water Temperature
C1 - Fan 3 Status	C2 - Subcooling	Fans %
C1 - Fan 4 Speed Feedback	C2 - Suction Pressure	Fans Communication Failure
C1 - Fan 4 Status	C2 - Suction Temperature	FC Circuit DP
C1 - Fan 5 Speed Feedback	C2 - Superheat	FC Fan Speed Request
C1 - Fan 5 Status	C3 and C4 Offline	FC Inlet Water Pressure
C1 - Fan 6 Speed Feedback	Circuit 1 - Compressor Inverter Communication Failure	FC Outlet Water Pressure
C1 - Fan 6 Status	Circuit 1 - Condensing Pressure Probe Failure	Free Cooling Failure
C1 - Fan 7 Speed Feedback	Circuit 1 - Evaporating Pressure Probe Failure	Free Cooling Failure 2
C1 - Fan 7 Status	Circuit 1 - Evaporating Temperature Probe Failure	Free Cooling Inlet Pressure Sensor Failure
C1 - Fan 8 Speed Feedback	Circuit 1 - Fans Failure	Free Cooling Outlet Pressure Sensor Failure
C1 - Fan 8 Status	Circuit 2 - Compressor Inverter Communication Failure	Free Cooling Pump Alarm
C1 - Fan 9 Speed Feedback	Circuit 2 - Condensing Pressure Probe Failure	Free Cooling Valve %
C1 - Fan 9 Status	Circuit 2 - Evaporating Pressure Probe Failure	Freecooling Status
C1 - Fan Speed Request %	Circuit 2 - Evaporating Temperature Probe Failure	Frequency
C1 - Fan Speed Request rpm	Circuit 2 - Fans Failure	Low Evaporator Water Flow
C1 - Fans Speed	Circuit 3 - Condensing Pressure Probe Failure	Low Evaporator Water Pressure
C1 - HP Switch	Circuit 3 - Evaporating Pressure Probe Failure	Missing Primary Water Flow
C1 - LCC Status	Circuit 3 - Evaporating Temperature Probe Failure	Pump %
C1 - Liquid Temperature	Circuit 3 - Fans Failure	Pump Alarm Code
C1 - LP Switch	Circuit 4 - Condensing Pressure Probe Failure	Pump Speed Feedback
C1 - Protection Threshold	Circuit 4 - Evaporating Pressure Probe Failure	Pump Speed Request
C1 - Speed	Circuit 4 - Evaporating Temperature Probe Failure	Remote Water DP
C1 - Subcooling	Circuit 4 - Fans Failure	Start FC at
C1 - Suction Pressure	Compressor %	Stop FC at
C1 - Suction Temperature	Compressor Cooling Request	Total Active Power
C1 - Superheat	Condenser Inlet Temperature Probe Failure	Total Aparent Power
C2 - Compressor Capacity	Condenser Outlet Temperature Probe Failure	Total Reactive Power
C2 - Compressor Status	Condensing SP	Unit Delta T
C2 - Condenser Fans Control	Control Mode	Unit Inlet Temperature Probe 2 Failure
C2 - Condensing Pressure	Cooling Cap - Capacity Trend	Unit Inlet Temperature Probe Failure
C2 - Condensing SP	Cooling Cap - DX (daily avg)	Unit Inlet Water Temperature

**Table 10.6 Chiller Points Available (continued)**

C2 - Condensing Temperature	Cooling Cap - DX (real time)	Unit Outlet Temperature Probe 2 Failure
C2 - Control Mode	Cooling Cap - EER (daily avg)	Unit Outlet Temperature Probe Failure
C2 - EEV Control	Cooling Cap - EER (real time)	Unit Outlet Water Temperature
C2 - EEV Opening Position	Cooling Cap - FC (daily avg)	Unit Status
C2 - Fan 1 Speed Feedback	Cooling Cap - FC (real time)	Valve Opening Request
C2 - Fan 1 Status	Cooling Cap - pPUE (daily avg)	Voltage L1 / L2
C2 - Fan 10 Speed Feedback	Cooling Cap - pPUE (real time)	Voltage L2 / L3
C2 - Fan 10 Status	Cooling Cap - Total FC + DX (daily avg)	Voltage L3 / L1
C2 - Fan 2 Speed Feedback	Cooling Cap - Total FC + DX (real time)	Water Flow
C2 - Fan 2 Status	Cumulative Power Consumption	Water Flow Filtered Value
C2 - Fan 3 Speed Feedback	EEV 1 Driver - Communication Failure	

This page intentionally left blank



# 11 Software and License Updates

We recommend protecting your Vertiv™ Liebert® iCOM™-S set up by performing a manual, full system backup before the software update. Refer to [Backup/Restore](#) on page 103.

## 11.1 Manual Software Update

Users can obtain the update file from a Vertiv representative. Save the file to a USB drive and insert the USB drive into a port on the Vertiv™ Liebert® iCOM™-S appliance.

**NOTE:** Before proceeding it is important to note the version and branch upgrading from. If the branch is changing (between development, release, or master), it is recommended to uninstall the current version before upgrading to the latest.

**NOTE:** Never install an older version of software on a more recent version. If required to go to a prior version, then the backup from the prior version will be required for restoration after a complete wipe. Please contact your local Vertiv service representative/technician for verification to do this.

Figure 11.1 Identifying Current Release

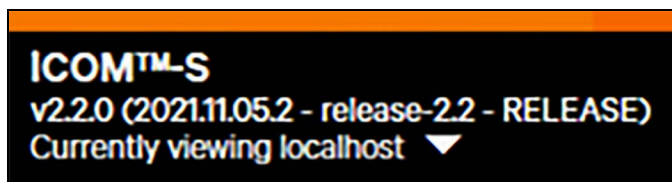

To manually complete the software update:

1. Click the **Service** menu, then click on the **iCOM™-S Software** menu.
2. Select either **Update** or **Safe Update**.
3. This will open Windows File Explorer. Select the new Liebert® iCOM™-S software update. If **Safe Update** is selected, the Liebert® iCOM™-S will also have you select a file location to save a backup of the system.
4. The Liebert® iCOM™-S system will restart and update with the new software updates. When prompted click enter on the system.

**NOTE:** The Liebert® iCOM™-S software version is located in the top left. The format is VX.X.X build date).

**NOTE:** If you are having an issue with a large software update, it may help to stop all services before completing the update.

**NOTE:** Running the standalone Liebert® iCOM™-S installer on an internet connected PC will automatically check for a newer version of the software and allow downloading of it (and all required installation files) for saving to USB for then manually updating a non-internet connected system.

## 11.2 Cloud Software Updates

Users can also update their system automatically if the system is connected to the cloud.

To check for cloud software updates:

1. On the **Home** tab, click the **Service** menu. Then click on the Vertiv™ Liebert® iCOM™-S **Software** menu.
2. Select **Check for Update** in the Cloud Software Update.

3. This will search the cloud for a new Liebert® iCOM™-S software revision for the system.
4. Click **Update**. The update will be downloaded. After the update has completely downloaded, the system restarts and the update process will run.

**NOTE: Liebert® iCOM™-S does not complete a Safe Update when using cloud software updates. It is recommended to ensure that the system was correctly backed up from the morning.**

# 12 Frequently Asked Questions

## 12.1 Networking

### **To use the new Vertiv™ Liebert® iCOM™-S, do you still need a Vertiv™ Liebert® vNSA or in-unit Network Switch SFA to connect various cooling units together?**

With or without Liebert® iCOM™-S, Thermal Units need to be networked together for teamwork functionality to occur. This can be done via Liebert® vNSA (network switch with or without Liebert® iCOM™-S display), SFA for daisy chaining units, standard off the shelf networking switch, or the network switch that comes pre-installed inside the traditional Liebert® iCOM™-S touchscreen panel enclosure. The new Liebert® iCOM™-S 1U workstation appliance has dual Ethernet ports (1GB/10GB). This allows the customer to network the 10GB port (bottom of the two ports) to an existing device network (that would have units already networked together through a switch of some sort). Only Vertiv units should be integrated into this network.

### **How does the Liebert® iCOM™-S Gateway (RDU301) reduce IP management?**

Instead of having to run separate Ethernet cables to each Thermal unit to the monitoring (Unity) card with each card having a separate/individual IP address organized and managed by the customer's IT/BMS/DCIM group, unit data/calculations plus supervisory level data/metrics from the Liebert® iCOM™-S are made available through a single IP on the iCOM™-S system served up by Modbus/BACnet IP servers. Tools within Liebert® iCOM™-S allow easy customizable modification of these point mappings that can be standardized on across customer sites. Without the Liebert® iCOM™-S, all of the units would still need to be networked together for Teamwork functionality but there would be separate BMS connections to each individual device which then drives complexity in IP management, security, network traffic, additional equipment/deployment times, etc.

### **Can users reuse same IP addresses for multiple spaces with multiple Liebert® iCOM™-S Gateways (RDU301)?**

The Liebert® iCOM™-S Gateway (RDU301 appliance) is a dual Ethernet device that allows a private network of devices to be connected to the LAN2 (southbound/private) Ethernet port with a single IP address on a different network/subnet on the LAN1 (northbound/operations network) Ethernet port. This allows IP addresses and Group/U2U IDs to be re-used across private (non-network visible) network subnets. When redundant Liebert® iCOM™-S gateways are set up in clusters, each iCOM™-S Gateway consumes one IP on both the southbound/private and northbound/operations networks respectively.

### **Can customers use their own virtual network or is a physical network switch required?**

We have had customers use their own vLANs in the past but Vertiv does not support these applications from a troubleshooting/networking configuration perspective. There are several things to remember:

- Vertiv equipment should be on their own private subnet/network. Broadcast traffic from large Vertiv Thermal (control board) Unit networks have caused issues with other vendor's equipment when placed on the same network.
- When using private vLANs, it is more likely that duplicate IPs or Teamwork Group/Unit IDs could exist (it is easier to span different physical spaces) so extra caution should be used here.
- The Teamwork thermal unit protocol is a non-routable protocol and therefore all units in the same group need to be on the same network/subnet as the protocol (service) responsible for that group running on either the Liebert® iCOM™-S or iCOM™-S Gateway (RDU301 appliance).

## 12.2 Pricing/Licensing

### **Are there any annual fees or licensing renewal for Vertiv™ Liebert® iCOM™ Software?**

There is a licensing fee when the system is initially purchased based on deployment mode, quantity, and types of connected devices. This license fee is a one time amount and is not recurring. By default, a (Remote) Basic recurring service contract is selected on the order. This includes access to software update notifications/software along with other remote support services including remote diagnostics support. It is highly recommended to renew this minimal cost contract to ensure access to the latest software and general support.

### **If a customer has the Liebert® iCOM™-S with Monitor only option, is there a way to upgrade to Optimize later?**

Yes, this can be completed by paying the price difference and updating the system license file that unlocks the functionality/screens in the software. Please work with your Service Business Development Manager (BDM) on pricing out the upgrade for your specific system to ensure the scope/quote is correct around the labor and any additional equipment/commissioning that may go along with this upgrade.

### **If a customer has a Liebert® iCOM™-S under an Essential service contract, will future software updates be covered/provided under the contract?**

Yes, access to the latest Liebert® iCOM™-S, iCOM™-S Gateway (RDU301 appliance) and Vertiv™ WSN Wireless Equipment software/firmware updates are covered under an Essential service contract for the system. Keep in mind, the Basic and Essential recurring service contracts are Remote based contracts where the customer/technician provides temporary remote connectivity to the system for Vertiv to complete the service. Remote implementation of the updates would include the Liebert® iCOM™-S and Wireless Gateway firmware. This would not include updating of the wireless sensor firmware as that is manually completed on-site.

Preferred service contracts include on-site visits where all Liebert® iCOM™-S, iCOM™-S Gateway (RDU301 appliance) and Vertiv™ WSN software/firmware is updated.

Cooling equipment upgrades and labor to complete cooling equipment upgrades are not included in recurring service contracts but can be priced accordingly. Please contact your Service BDM for quoting.

## 12.3 Demos

### **Are there any online demos available?**

We currently do not have a public demo available but frequently support remote customer presentations/demonstrations when required.

Please contact your local Vertiv account or sales manager for additional information, if desired.

## 12.4 Vertiv™ Liebert® iCOM™-S Gateway (RDU301)

**Do users need one RDU301 gateway per site or is it one RDU301 gateway for all sites assuming the software version is used?**

The Liebert® iCOM™-S Gateway (RDU301) allows cross network/subnet device connectivity and additional calculation compute capabilities if needed. If all devices are on the same private network and can be networked to a single private NIC (Network Interface Card – Ethernet port) on the Liebert® iCOM™-S, then an iCOM™-S Gateway is not required and is optional only. This applies to the 1U, traditional panel/enclosure, or Server variations of the iCOM™-S appliance. In small (1U) and medium (panel) applications this is the most likely scenario. In distributed, software only (server based) applications the chances of devices being on separate networks or the need to duplicate IP or Group/U2U ID addresses across rooms in the same building on their own private networks is much higher. This is where the iCOM™-S Gateway can assist greatly.

**How are resources distributed with the Liebert® iCOM™-S Gateway (RDU301)?**

**Resources** in this context would be Services or functionality. Today we have containerized/distributable functionality of GBP (Thermal Teamwork protocol), Vertiv™ WSN (Wireless protocol – API/eventing) and calculations that can be deployed to the Liebert® iCOM™-S Gateways (RDU301s). When a single Liebert® iCOM™-S Gateway (RDU301) is used, the application determines which of the two protocols (GBP or WSN) need to be distributed or run on the RDU. This is primarily a function of the networking architecture. Calculations are not network dependent and therefore can be run on the server/panel or on the Liebert® iCOM™-S Gateways. With the new software, we've simplified this management as we know it can be a confusing concept. The Liebert® iCOM™-S now automatically manages the removal and deployment of these "resources" based on the network connectivity of the devices back to the iCOM™-S (while still allowing manual modification if desired).

An example: a user added a wireless gateway to the system using the Quick Start guide. The user/technician can select physically at which layer they want to add the wireless gateway to the system. This could be directly to the Liebert® iCOM™-S or through any available cluster of iCOM™-S Gateways on the system.

After this selection is made the Liebert® iCOM™-S will automatically deploy the functionality to that cluster to communicate/calculate points required for that object on the backend without the user having to manage it.

If a Cluster has more than one Liebert® iCOM™-S Gateway (RDU301) in it, the iCOM™-S will automatically shift this functionality between the available iCOM™-S Gateways to balance them accordingly. From that point on, if something happens to the system that effects the operation of an RDU (network cable disconnected from LAN1 or 2, maintenance mode activated on RDU for firmware update, power lost, etc.) the Liebert® iCOM™-S will remove the functionality from the negatively impacted iCOM™-S Gateway and will re-deploy it to another available iCOM™-S Gateway in that cluster attempting to self-heal the functionality that was lost.

Being that the calculation functionality is not southbound network dependent, this allows for compute flexibility to be shifted around the network. For instance, if there are a significant number of calculations being done or future heavy compute type calculations are to be done, a user could add a dedicated computer Liebert® iCOM™-S gateway to the network and then shift these calculations to that iCOM™-S, essentially offloading the resources from the server. Shifting Site/Room/Unit calculations from the server or heavily loaded clusters to other clusters on the network would be a use case today.

**When would you use a distributed connection vs. direct connection?**

Most likely for:

- Applications when you have Thermal Units on different networks/subnets from the Liebert® iCOM™-S1U/panel/server (when you need to route thermal device network traffic from private network).
- Applications when you want to have mirrored IP addresses or Group/U2U ID's across zones/rooms.
- Applications that are server/SW based, especially when the provided Servers only have 1 IP address (NIC – Network Interface Card).
- Applications where a 1U/Panel is becoming constrained by hardware limitations due to calculations being done.

## 12.5 Remote Connectivity

**For the software version, does it mean the client would be using their own workstation, PC or iPads to login to the software? Any limit?**

For all three versions (1U, panel/enclosure, Software only) the following Remote Connections are available.

- **Web Interface** – In addition to the desktop UI, Vertiv™ Liebert® iCOM™-S contains a web-based UI. This is designed to look and feel very much like the desktop UI, which minimizes the learning curve. Not all UI functionality is available through the Web UI when compared to the Desktop UI. For the full Liebert® iCOM™-S UI experience, the Desktop UI (either local or remote) is recommended.
- **Remote Desktop Application** – This is a thick/installed Windows application that can be installed on a laptop, desktop or workstation. You can add multiple Liebert® iCOM™-S Systems (IP addresses) to this UI so that when it starts up any previously added system can be selected for a 1:1 connection. This provides the same Liebert® iCOM™-S experience as the full UI running natively/locally on the iCOM™-S server.
- **Windows Remote Desktop Connection** – This allows a user to remotely log on to the Liebert® iCOM™-S server for either visibility or remote management of the iCOM™-S software or any backend software running on the Server. The credentials here are both Windows and Liebert® iCOM™-S based depending on desired access/security requirements.

**NOTE: Typically only one Windows client can be connected to a system at one time.**

There is a configurable value limiting the number of simultaneous connected clients based on the hardware capabilities and the amount of load on the system. By default, this is five but given the performance improvements made in the software this could easily be adjusted higher if needed based on the customer requirements.

## 12.6 BMS External Connectivity

**How would you comply to Tier 4 design using a single Vertiv™ Liebert® iCOM™-S connection to BMS?**

This is a complex question and varies between Tier 4 certifications with application specific requirements. Here are some options for further investigation for the application:

- The simplest approach would be to run parallel BMS paths, one direct to the units via a Unity Card connection and one direct to the Liebert® iCOM™-S. This would give visibility to unit data/alarms through both network paths. It would have to be decided if calculations/metrics provided by the Liebert® iCOM™-S only were lost, if this would still qualify as no loss of unit data.
- Run two Liebert® iCOM™-S systems in parallel set up the same except the iCOM™-S panel would be different U2U IDs on each connected Thermal Teamwork group. This would provide a fallback BMS IP address that would provide nearly identical data (given calculation time offsets between the two systems). This could be accomplished through two physical appliances or through two separate VMs running separate instances of Liebert® iCOM™-S software.
- In either of the cases above if this was unacceptable, an HA proxy could be examined for evaluation on either scenario. Code development would probably be required for proper loss of data trigger of HA proxy switchover events.

If specific viable opportunities require this, please contact the factory for further evaluation of feasibility.

## 12.7 General Features

### Does the Airflow Effectiveness feature require power meters on Vertiv™ Liebert® DSE units?

The Airflow Effectiveness calculation does not require power meters as it is an airflow effectiveness calculation where the amount of airflow for a unit is divided by the Net Sensible Cooling Capacity of the unit (at altitude). The Net Sensible Mechanical Efficiency calculations do require the power meters and are calculated the same as a PUE with the assumption that the Net Sensible Cooling Capacity of the unit matches the IT load being handled by that unit.

### What control algorithms are in Vertiv™ Liebert® iCOM™-S to get additional energy savings in addition to unit networking/teamwork energy savings?

An estimated 80/20 split on the energy benefits of native Unit Teamwork to Unit Teamwork with Liebert® iCOM™-S.

- There are selectable hot spot protection levels where customers can easily click a single button to change from Best (Max), Better (Avg.) or Good (sliding/scaled calculation allowing warmer temperatures with more protection towards warmer end of temperature spectrum).
- Cross group sensor integration into the calculations also allows more stable operation in the space when multiple groups of units are configured in that space.
- The wireless integration also allows longer term energy savings by allowing easier and more maintainable sensor placement to ensure the sensors are not controlling the units based on non-optimized sensor locations (as loads/placement changes over time).
- Majority of smaller sites lack Teamwork integration/configuration. Using the Liebert® iCOM™-S draws their attention to that as it's a pre-requisite which only benefits them.

### Do you have any examples of reports that can be shared?

If you're referring to what can be exported/extracted from the Liebert® iCOM™-S that can be provided to the commissioning agent for system validation/their commissioning report inclusion they are primarily these:

- Diagnostic Utility – Full System Report: Exported using the Diagnostic Utility program (installed by default on every Liebert® iCOM™-S system). Provides a small \*.html report that gives an overall system report including the status of backend services, licensing, control group associations, IP addresses, device firmware versions, configuration variable across system, etc.
- Room Configuration Reports - Exported using the Room Configurator program (installed by default on every Liebert® iCOM™-S system). Provides a PDF room report (selectable by user on export) that includes visually placed objects on the floor plan along with associated properties of each object including auto-discovered/set IP addresses, device firmware versions, min/max thresholds when applicable, sensor location type property (cold/hot aisle for instance), etc.
- BMS Point Configuration Export - Exported using the Point Configurator program (installed by default on every Liebert® iCOM™-S system). Provides a \*.csv Point export of every configured BMS point on the system along with associated properties dependent on Modbus vs. BACnet.
- Data Reports - Exported either manually/ad hoc or automatically (to file/email) using the Liebert® iCOM™-S User Interface. Report types include instantaneous properties/values, historical/statistical values of important data points, or high-resolution specific point data. Used for generating graphs/trends.

This page intentionally left blank



# Appendices

## Appendix A: Technical Support and Contacts

### A.1 Technical Support/Service in the United States

Vertiv Group Corporation

24x7 dispatch of technicians for all products.

1-800-543-2378

Liebert® Thermal Management Products

1-800-543-2378

Liebert® Channel Products

1-800-222-5877

Liebert® AC and DC Power Products

1-800-543-2378

### A.2 Locations

#### United States

Vertiv Headquarters

505 N. Cleveland Ave.

Westerville, OH 43082, USA

#### Europe

Via Leonardo Da Vinci 8 Zona Industriale Tognana

35028 Piove Di Sacco (PD) Italy

#### Asia

7/F, Dah Sing Financial Centre

3108 Gloucester Road, Wanchai

Hong Kong

This page intentionally left blank

## Appendix B: Submittal Drawings

Below is a list of related submittal drawings. The drawings follow the list and are presented in the same order as the list.

**Table B.1 Submittals**

Submittal Number	Title
DPN003318	Liebert® iCOM™-S Cabinet Dimensional Wall Mount
DPN003320	Liebert® iCOM™-S Component Location Wireless Sensor
DPN003331	Liebert® iCOM™-S Vertiv™ WSN Application
DPN003332	Liebert® iCOM™-S Electrical Connections for Wired Application
DPN005171	Liebert® RDU Dimension Data Vertiv™ RDU-301 Desktop Mount
DPN005190	Vertiv Wireless Application Remote Mounting Kit & Antenna

This page intentionally left blank

## CABINET DIMENSIONAL DATA WALL MOUNT

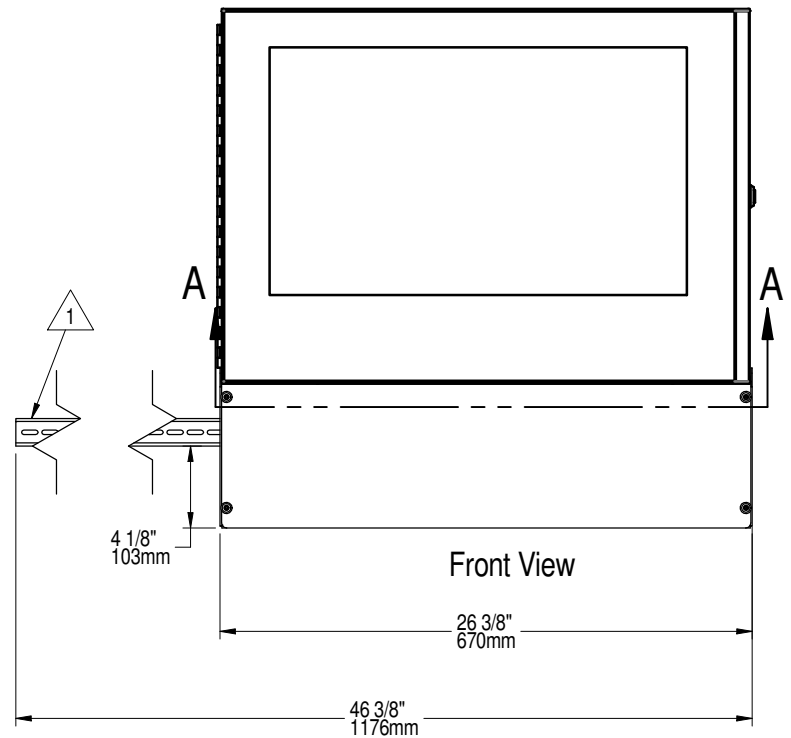
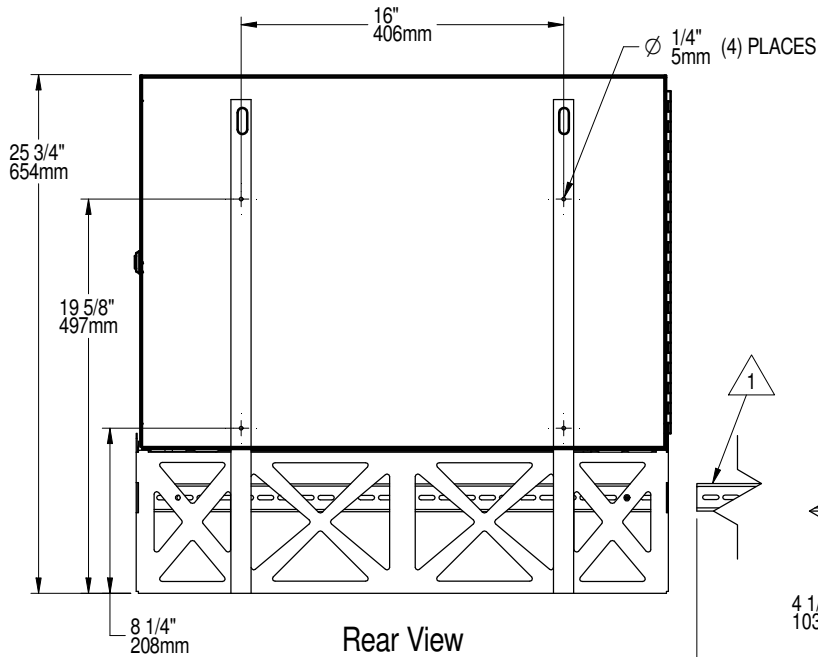
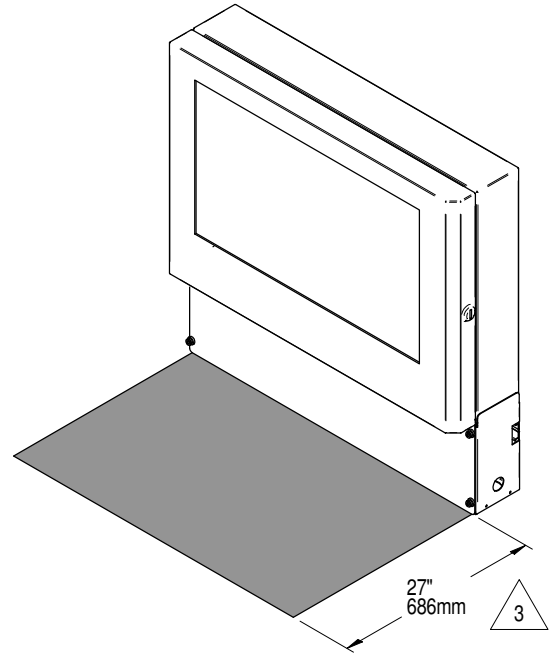
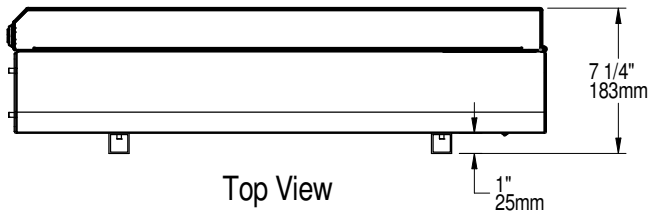

NOTES:

1. DIN RAIL SHOWN EXTENDED TO SHOW IT CAN HOLD A SINGLE GATEWAY.  
DIN RAIL NOT EXPOSED WHEN SHIPPED.  
SEE MANUAL FOR FURTHER INFORMATION.
2. WEIGHT: 57LB (24.94KG) WITH NO GATEWAYS/CABLES
3. SHADED AREA INDICATES THE RECOMMENDED MINIMUM CLEARANCE FOR COMPONENT ACCESS.
4. SEE ELECTRICAL SUBMITAL DPN003320 AND UNIT MANUAL FOR MORE INFORMATION

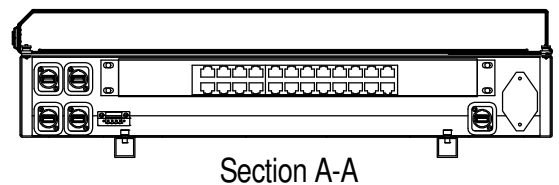

## CABINET DIMENSIONAL DATA DESK/TABLE MOUNT

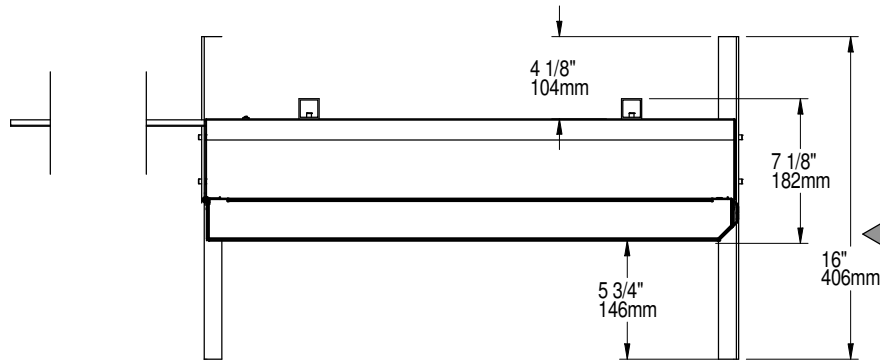

Top View

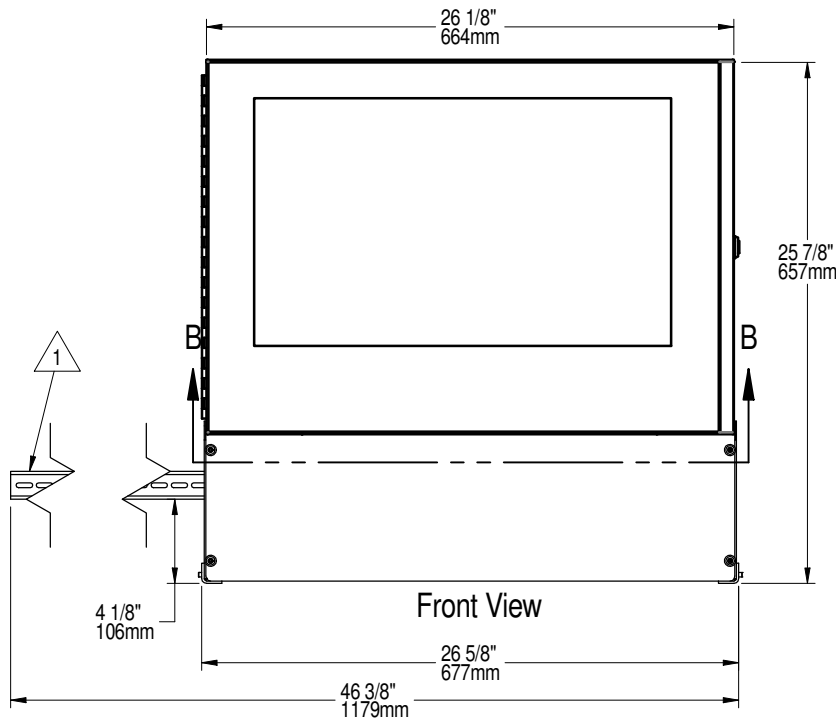
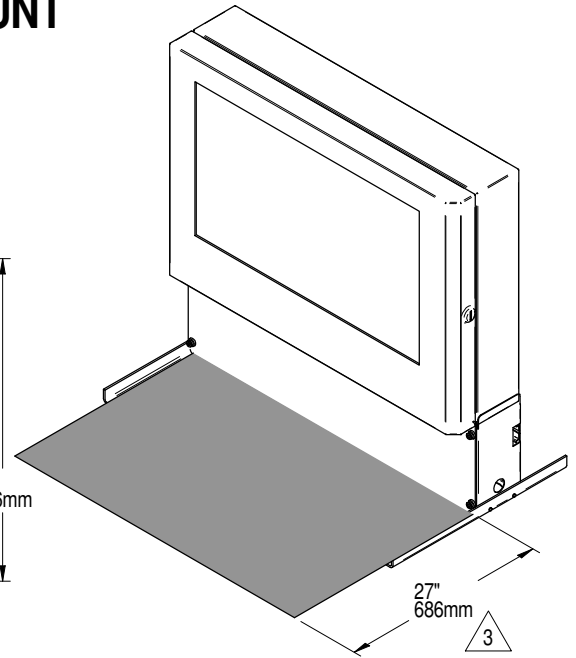

Front View

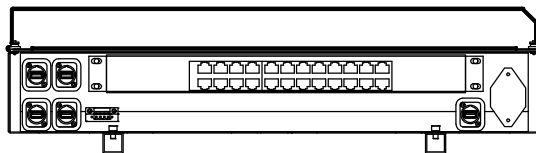

Section B-B

NOTES:

1. DIN RAIL SHOWN EXTENDED TO SHOW IT CAN HOLD A SINGLE GATEWAY. DIN RAIL NOT EXPOSED WHEN SHIPPED. SEE MANUAL FOR FURTHER INFORMATION.
2. WEIGHT: 57LB (24.94KG) WITH NO GATEWAYS/CABLES
3. SHADED AREA INDICATES THE RECOMMENDED MINIMUM CLEARANCE FOR COMPONENT ACCESS.
4. SEE ELECTRICAL SUBMITAL DPN003320 AND UNIT MANUAL FOR MORE INFORMATION

## COMPONENT LOCATION WIRELESS SENSOR

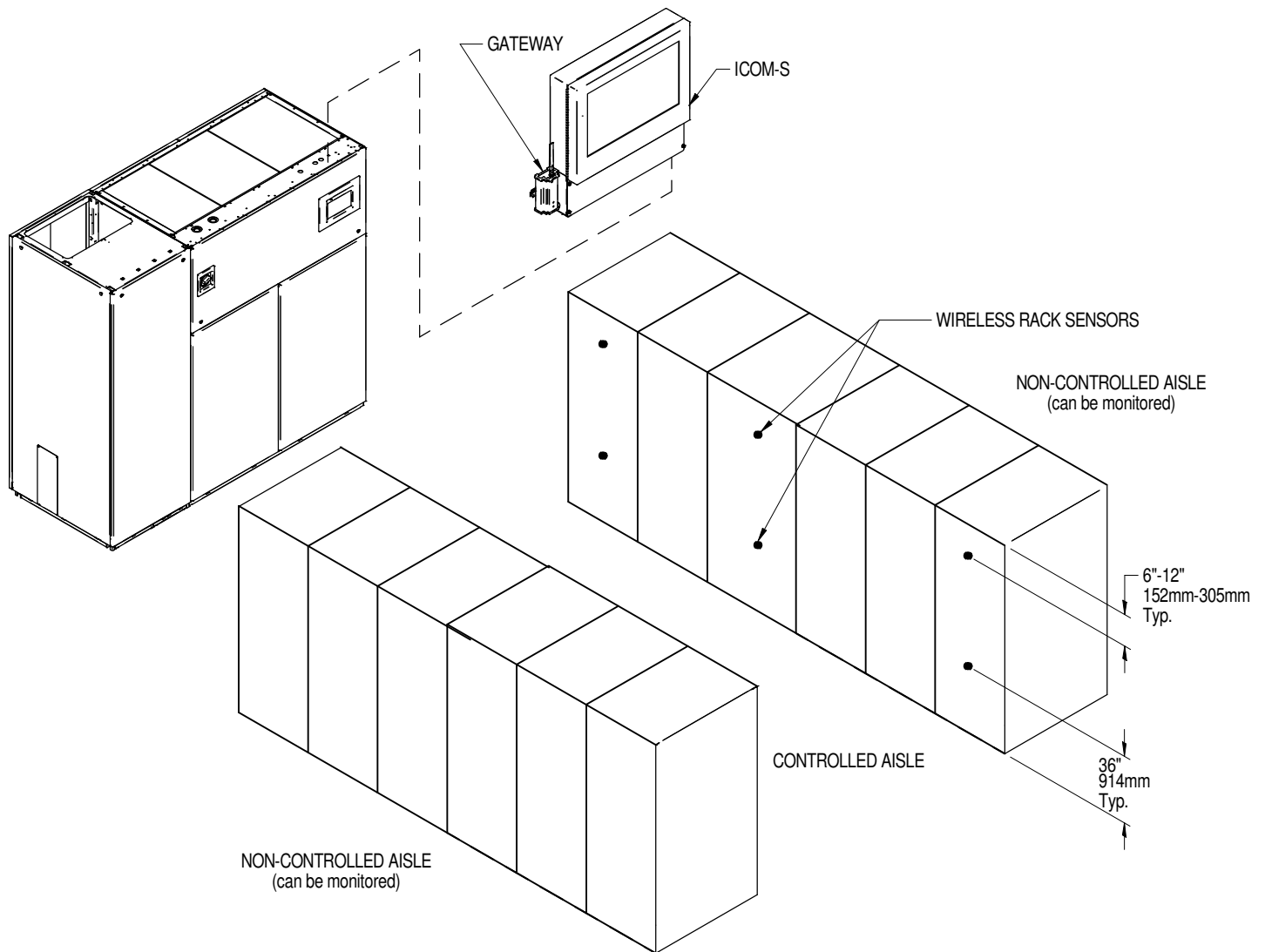

Application	Recommendation
Non-contained aisle control applications	Minimum of two sensors per controlled standard rack face Each 3rd rack has sensors
Contained aisle control applications	Minimum of two sensors per controlled standard rack face Each fourth rack has sensors
End racks on rows	Has sensors to detect wrap-around air flow Racks in between should use guidelines above
Standard rack face	Typical locations are 6" (152mm) to 12" (305mm) from top of rack (depending on the location of rack equipment) Half way (typically 36" (914mm))
Additional sensors can be used as needed for more granular control or monitoring	

**NOTE:**

1. Rack Sensor provided by VERTIV  
Sensor Provided by VERTIV and is installed by other
2. Install temperature sensors on the perforated portion of the rack door using the supplied sensor mounting kit.
3. Mounting method for sensors: Factory provided sensor mounting kit supports magnet, zip ties, and wall screws.

## VERTIV WSN APPLICATION MOUNTING/POWERIN OPTIONS

Option	#1	#2	#3
<b>Type</b>	Touchscreen Panel Appliance Gateway Mounting (Touchscreen panel appliance only)	Remote Gateway Mounting Using Vertiv Provided Remote Mounting Kit (Touchscreen panel appliance, 1U appliance or SW Only deployments applicable)	Loose Mounting Method Using Vertiv Provided Wall Outlet Power Adapter (Touchscreen panel appliance, 1U appliance or SW Only deployments applicable)
<b>Further Explanation</b>	This option is only available when using an iCOM-S Touchscreen Panel Appliance based system. In the wall mount bracket of the panel appliance there is a slide out din rail that can support up to 3 WSN Gateways. Each Gateway as standard ships with a barrel plug adapter to bare wire leads. The barrel plug end of this adapter screws into the WSN Gateway with the wire leads being connected to the screw in terminals on the Phoenix adapter present on the bottom of the iCOM-S enclosure. This is powered by an internal transformer within the panel enclosure itself.	This is the most common installation option for the iCOM-S 1U and SW only deployments where a wall mount bracket with slide out din rail is not available (on the touchscreen appliance). This option requires the purchase of the 1410-MOUNTKITS remote gateway mounting kit. The remote mounting kit provides a short section of din rail with a din rail mounted transformer so that a WSN Gateway can be remotely mounted / powered away from the iCOM-S appliance. Barrel plug to wire lead adapter that ships as standard with the WSN Gateway to be used for power from the transformer. Field provided hard wire from utility to transformer.	This is the simplest installation option. Field mounting of gateway can be achieved either by mounting the WSN Gateway to a din rail or the din rail adapter on the WSN Gateway can be removed so the back of it can be flush with the final mounting surface (field provided non magnetic means). Power to the WSN Gateway is provided by a standard wall wart power adapter with barrel plug adapter which is included as standard with every WSN Gateway.
<b>Notes</b>	<ol style="list-style-type: none"> <li>1. No more than 3 WSN Gateways powered from iCOM-S panel enclosure</li> <li>2. No more than 3 WSN Gateways to be mounted on iCOM-S panel slide out din rail</li> <li>3. Power lead length from iCOM-S to furthest WSN Gateway on slide out din rail not to exceed length of din rail</li> <li>4. No continuous Ethernet cable lengths to exceed 328' without powered switch/repeater</li> <li>5. Recommended to put entire iCOM-S panel appliance on UPS power feed (which will also cover the WSN Gateway)</li> </ol>	<ol style="list-style-type: none"> <li>1. Transformer not to power more than 1 WSN Gateway</li> <li>2. Maximum wire length from transformer to WSN Gateway not to exceed 12"</li> <li>3. No continuous Ethernet cable lengths to exceed 328' without powered switch/repeater</li> <li>4. Recommended to power transformer from UPS power feed</li> </ol>	<ol style="list-style-type: none"> <li>1. Wire length of wall outlet power adapter not to be modified</li> <li>2. No continuous Ethernet cable lengths to exceed 328' without powered switch/repeater</li> <li>3. Recommended to have outlet power on a UPS power feed</li> </ol>

Option 1:  
TOUCHSCREEN PANEL  
APPLIANCE GATEWAY MONITORING  
(refer to page 2 & 3 for further details)

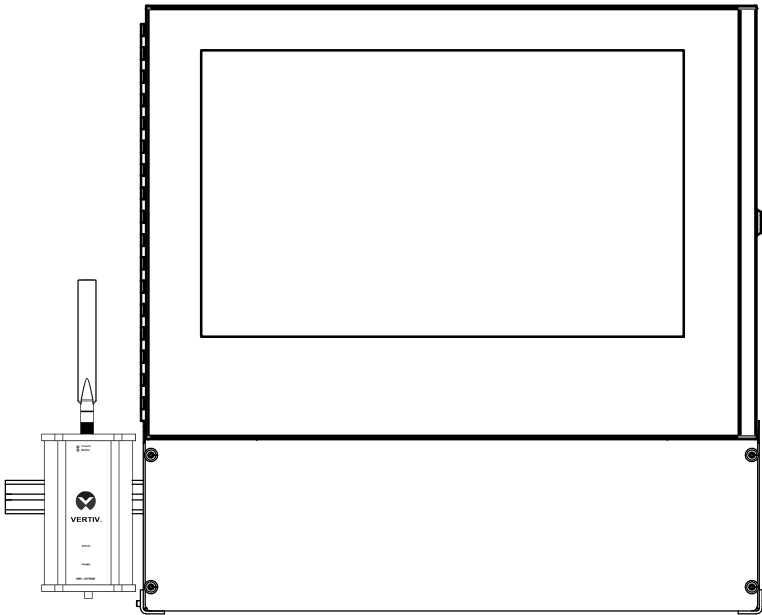

Option 2:  
REMOTE GATEWAY  
MOUNTING USING VERTIV  
PROVIDED REMOTE  
MOUNTING KIT  
(Refer to page 4 below for further details)

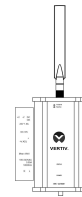

Option 3:  
LOOSE MOUNTING  
METHOD USING VERTIV  
PROVIDED WALL OUTLET  
POWER ADAPTER  
(Refer to page 5 below for further details)

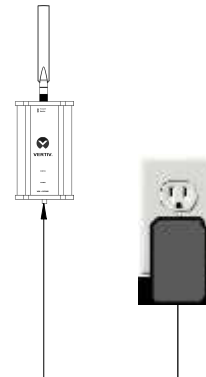



## TOUCHSCREEN PANEL APPLIANCE CONNECTIONS

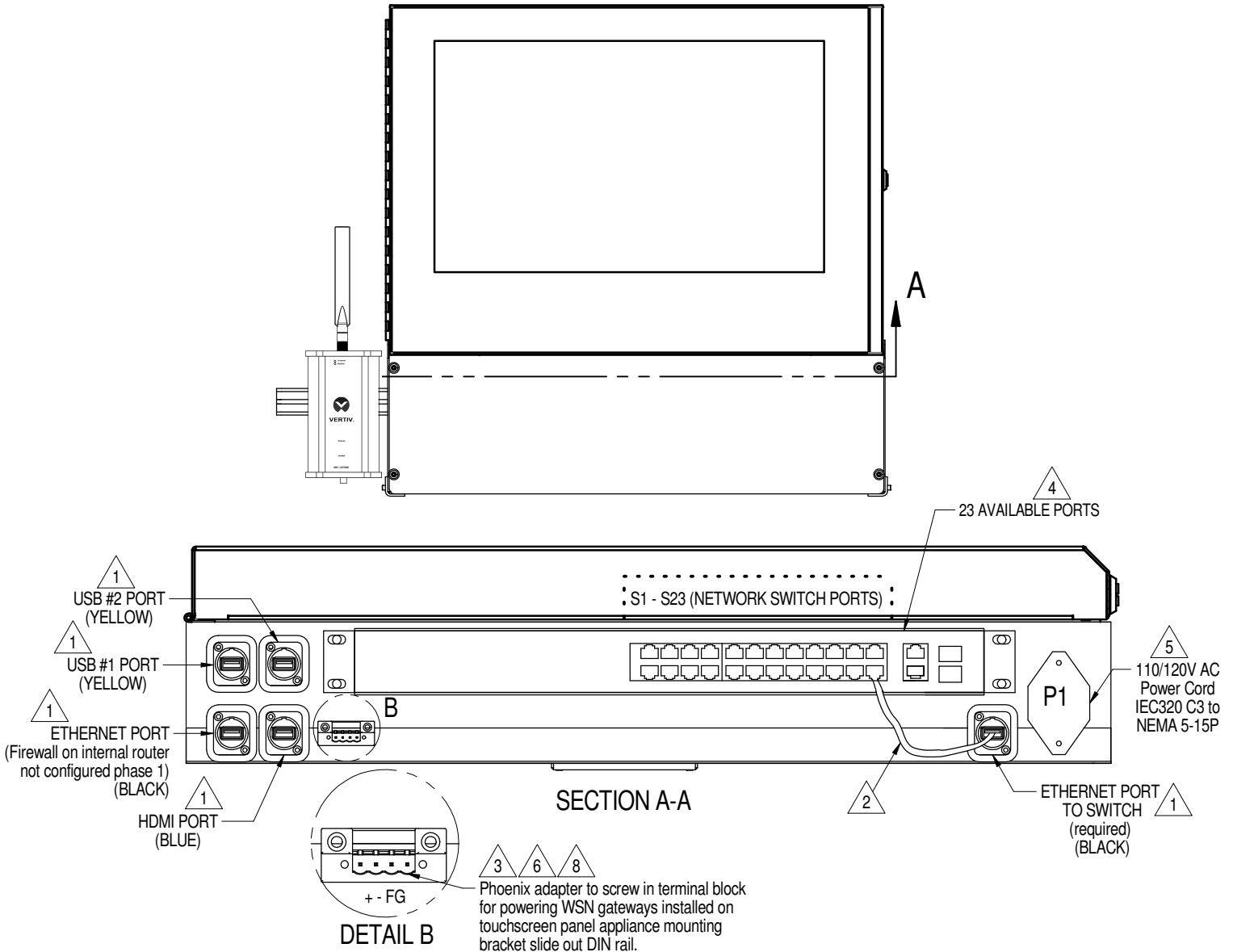

**NOTES:**

1. MAX CAT5E OR CAT6E SHIELDED CABLE RUN IS 328'
2. FACTORY SUPPLIED, FIELD CONNECTED ETHERNET CABLE.
3. SINGLE TWISTED PAIR, 18 AWG, USED FOR ONLY POWERING LIEBERT® iCOM™-S MOUNTING BRACKET DIN RAIL INSTALLED GATEWAYS.
4. 10/100/1000 BASE T ETHERNET PORT
5. FACTORY SUPPLIED, FIELD CONNECTED POWER CABLE.
6. POWER WIRING FIELD SUPPLIED AND INSTALLED. NOT TO BE USED IN LENGTH EXCEEDING LIEBERT® iCOM™-S DIN RAIL LENGTH DUE TO VOLTAGE DROP LIMITS.
7. NETWORK WIRING FIELD SUPPLIED AND INSTALLED.
8. NO MORE THAN (3) WSN GATEWAYS TO BE POWERED DIRECTLY FROM LIEBERT® iCOM™-S PHOENIX POWER CONNECTION.

## TOUCHSCREEN APPLIANCE VERTIV WSN CONNECTIONS OPTION 1

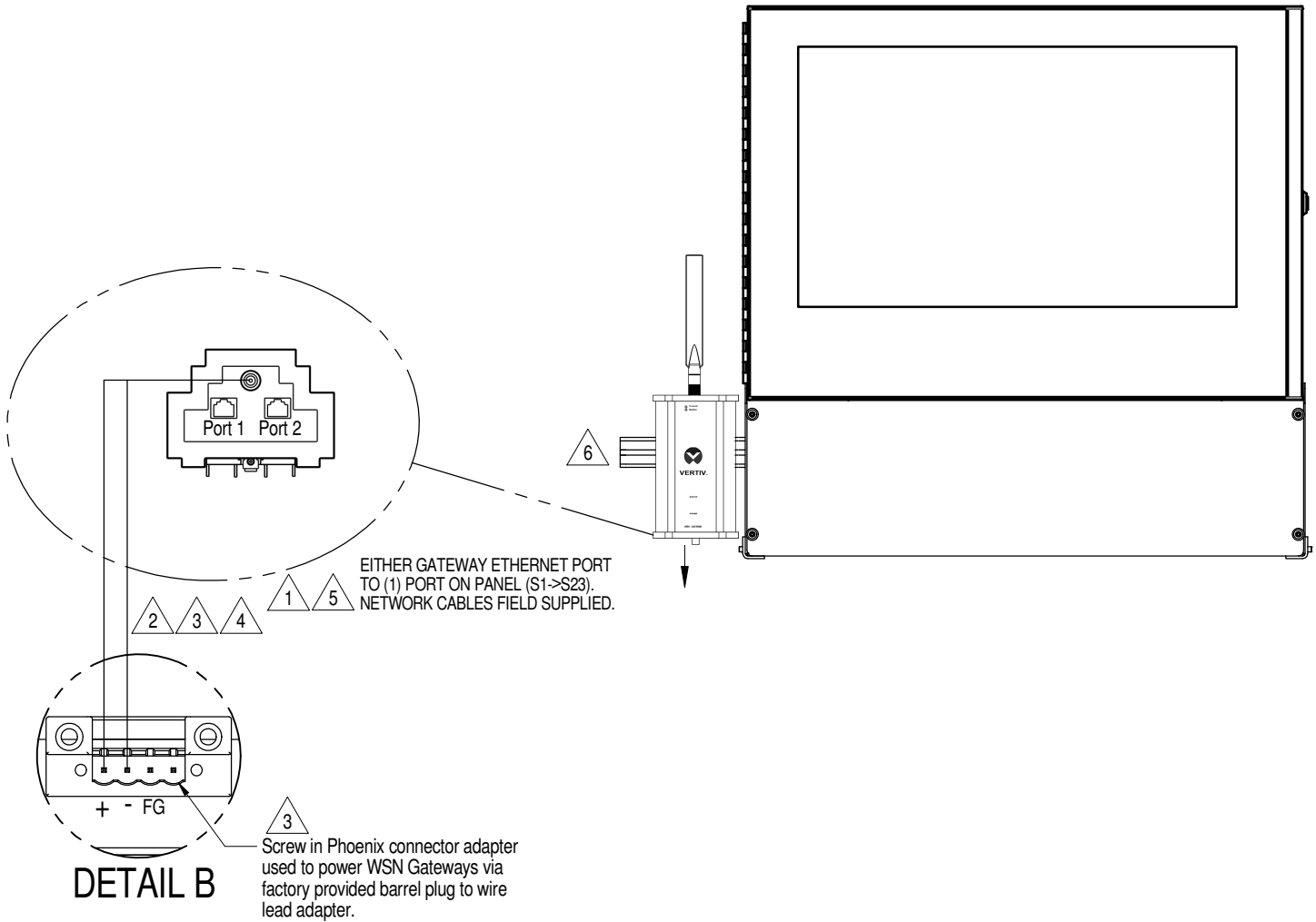

NOTES:

1. MAX CAT5E OR CAT6E SHIELDED CABLE RUN IS 328' (100m).
2. IF FIELD WIRING USED TO EXTEND FACTORY PROVIDED BARREL PLUG TO WIRE LEAD ADAPTER, USE RECOMMENDED WIRE TYPE, SIZE AND LENGTH.
3. SINGLE TWISTED PAIR, MIN AWG PER UL = 30. MAX AWG PER UL = 12. RECOMMENDED AWG = 18. MAX LENGTH = 10' (3m).
4. FACTORY SUPPLIED BARREL PLUG TO WIRE LEAD ADAPTER, FIELD INSTALLED.
5. ETHERNET CABLE FROM WSN GATEWAYS TO ETHERNET PORTS (S1 -> S23) ON LIEBERT® iCOM™-S PANEL SWITCH FIELD PROVIDED AND WIRED.
6. NO MORE THAN (3) WSN GATEWAYS POWERED DIRECTLY FROM LIEBERT® iCOM™-S PHOENIX POWER CONNECTION.
7. ALWAYS FOLLOW LOCAL ELECTRICAL AND NETWORKING CODES FOR COMPLIANCE.

## VERTIV WSN GATEWAY REMOTE MOUNTING KIT CONNECTIONS

### OPTION 2 (USING 1410 MOUNTING KITS)

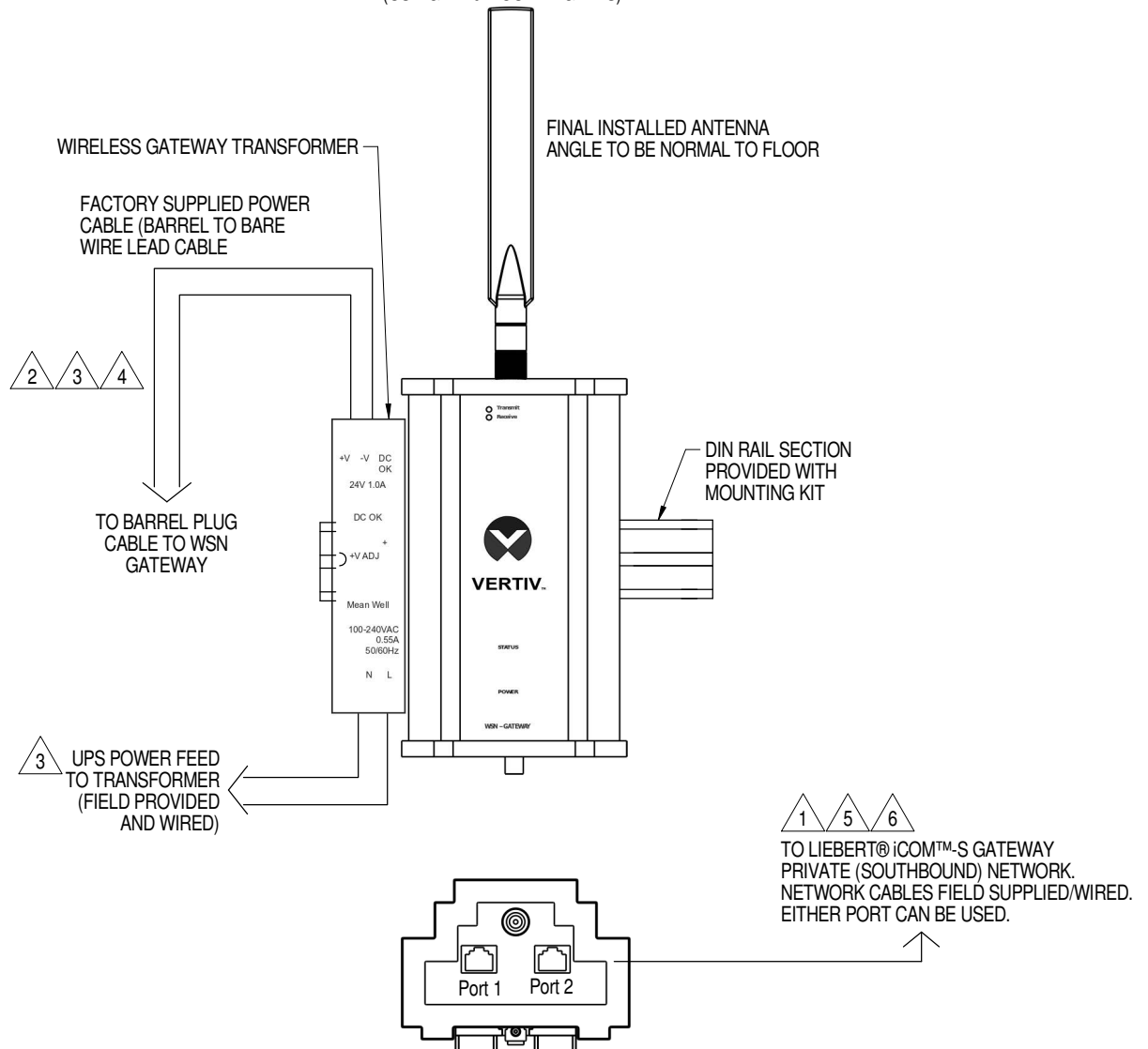

NOTES:

1. MAX CAT5E OR CAT6E SHIELDED CABLE RUN IS 328' (100m).
2. IF FIELD WIRING USED TO EXTEND FACTORY PROVIDED BARREL PLUG TO WIRE LEAD ADAPTER, USE RECOMMENDED WIRE TYPE, SIZE AND LENGTH.
3. SINGLE TWISTED PAIR, MIN AWG PER UL = 30. MAX AWG PER UL = 12. RECOMMENDED AWG = 18. MAX LENGTH = 10' (3m).
4. FACTORY SUPPLIED BARREL PLUG TO WIRE LEAD ADAPTER, FIELD INSTALLED.
5. SHIELDED CAT5E OR CAT6E ETHERNET CABLE FROM WSN GATEWAY TO LIEBERT® iCOM™-S/LIEBERT® iCOM™-S GATEWAY PRIVATE (SOUTHBOUND) NETWORK, FIELD SUPPLIED/WIRED.
6. ALWAYS FOLLOW LOCAL ELECTRICAL AND NETWORKING CODES FOR COMPLIANCE.

## VERTIV WSN GATEWAY FIELD MOUNTING CONNECTIONS OPTION 3

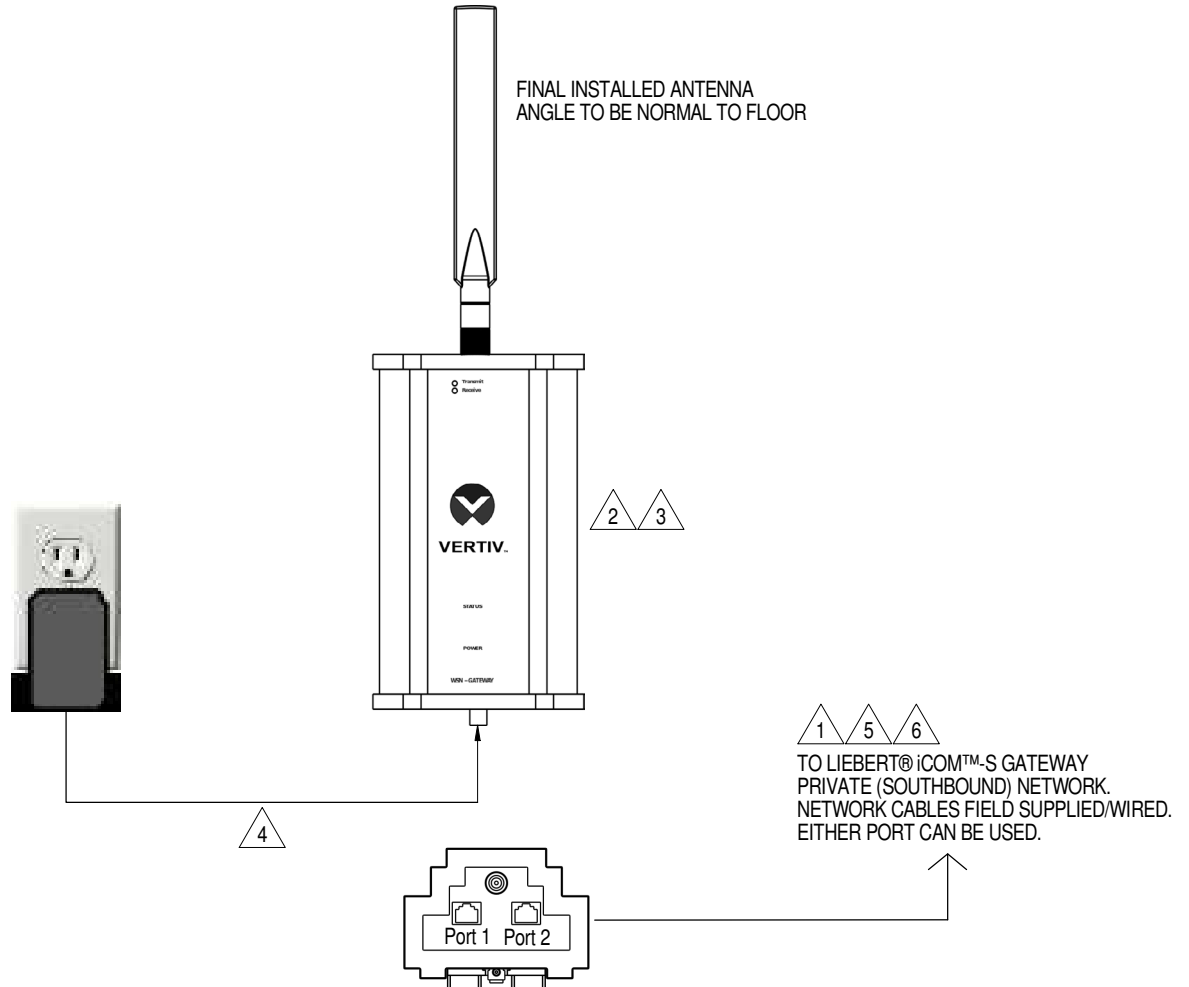

**NOTES:**

1. MAX CAT5E OR CAT6E SHIELDED CABLE RUN IS 328' (100m).
2. DIN RAIL ADAPTER ON BACK OF WSN GATEWAY CAN BE REMOVED FOR FIELD PROVIDED FLUSH MOUNTING IF DIN RAIL IS NOT BEING USED.
3. WSN GATEWAY WEIGHT SHOULD NOT BE SUPPORTED BY POWER OR ETHERNET CABLES CONNECTED TO THE GATEWAY.
4. 110/120V AC/60Hz WALL WART TO BARREL PLUG ADAPTER CABLE, FACTORY PROVIDED AS STANDARD WITH WSN GATEWAY, FIELD CONNECTED.
5. SHIELDED CAT5E OR CAT6E ETHERNET CABLE FROM WSN GATEWAY TO LIEBERT® iCOM™-S/LIEBERT® iCOM™-S GATEWAY PRIVATE (SOUTHBOUND) NETWORK, FIELD SUPPLIED/WIRED.
6. ALWAYS FOLLOW LOCAL ELECTRICAL AND NETWORKING CODES FOR COMPLIANCE.

## ELECTRICAL CONNECTIONS FOR WIRED APPLICATION

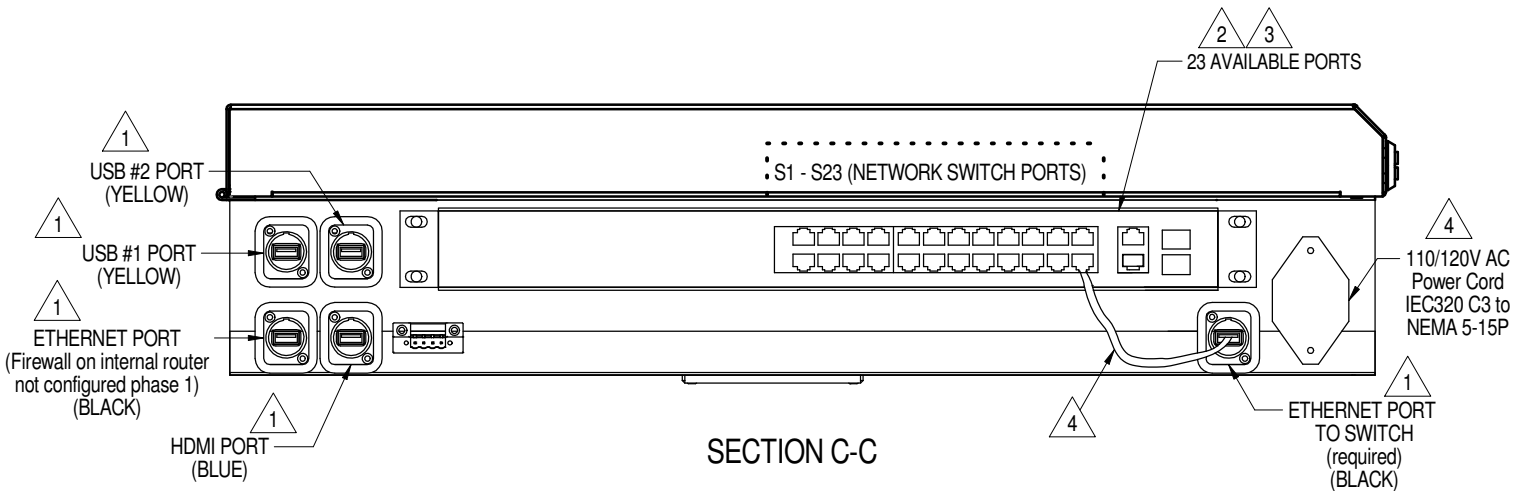
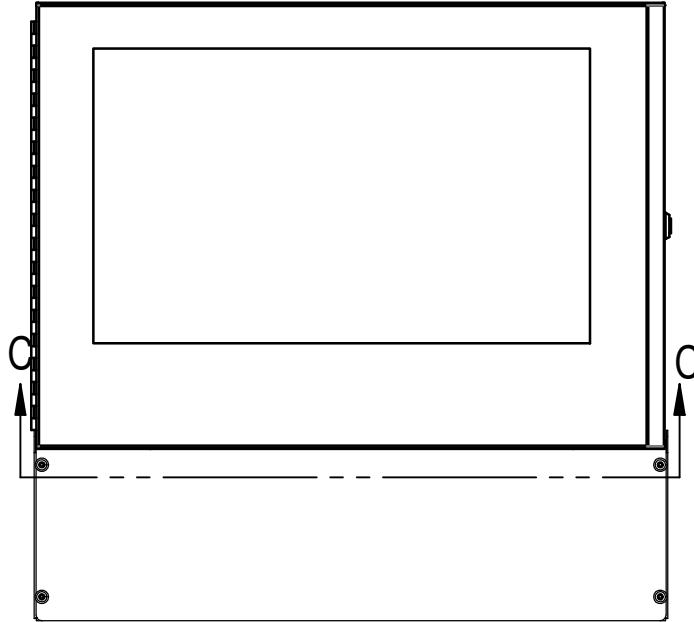

NOTES:

- 1. PRELIMINARY CONNECTION PORT LOCATIONS. EXACT PLACEMENT MAY BE DIFFERENT ON FINAL SHIPPED PRODUCT.
- 2. MAX CAT5E SHIELDED CABLE RUN IS 328'
- 3. SINGLE ACTIVE 10/100 BASE T ETHERNET PORT
- 4. FACTORY SUPPLIED, FIELD CONNECTED

# LIEBERT® iCOM™-S

## COMMUNICATION CONNECTION DIAGRAM FOR COOLING UNITS TO LIEBERT® iCOM™-S PANEL

LIEBERT® iCOM™-1 CONTROL BOARD WITH STANDARD 9 INCH COLOR TOUCHSCREEN  
LIEBERT® iCOM™ DISPLAY WITH SINGLE WIRE NETWORK CONNECTION.

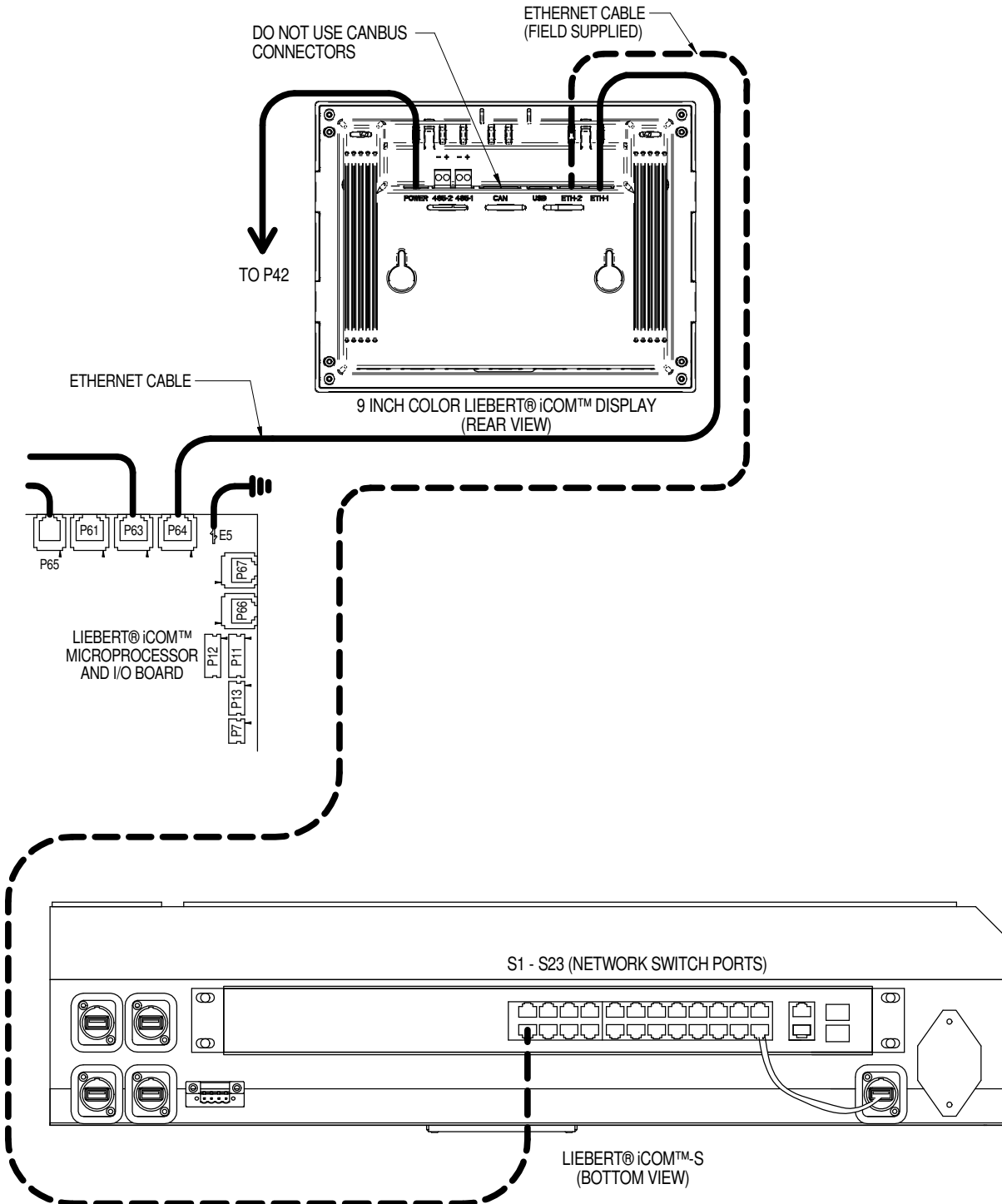

# LIEBERT® iCOM™-S

## COMMUNICATION CONNECTION DIAGRAM FOR COOLING UNITS TO LIEBERT® iCOM™-S PANEL

LIEBERT® iCOM™-1 CONTROL BOARD WITH STANDARD 9 INCH COLOR TOUCHSCREEN  
 LIEBERT® iCOM™ DISPLAY WITH SINGLE WIRE NETWORK CONNECTION.

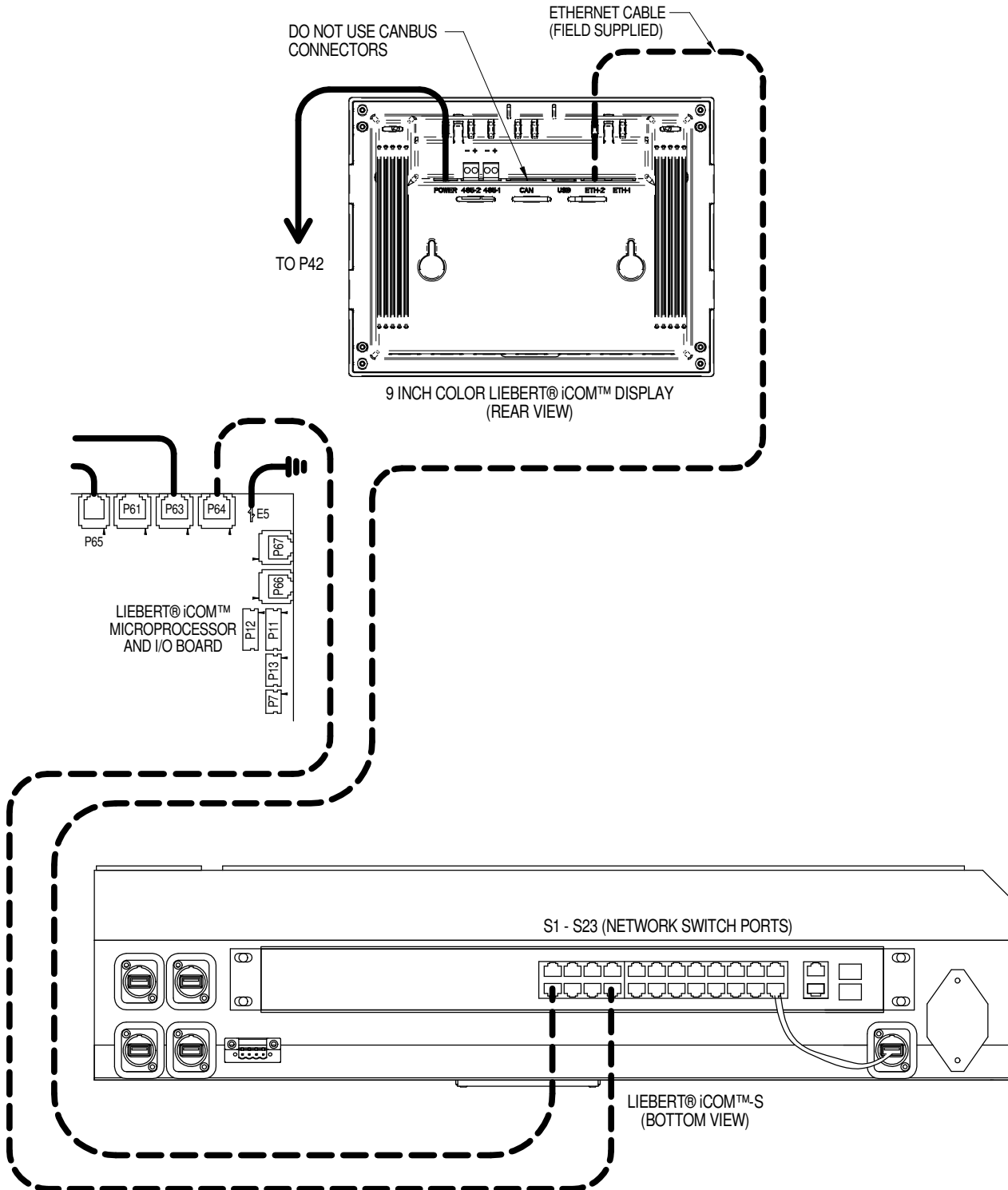

## UNIT TO UNIT NETWORK CONNECTIONS

LIEBERT® iCOM™-1 CONTROL BOARD WITH STANDARD 9 INCH COLOR TOUCHSCREEN  
LIEBERT® iCOM™ DISPLAY WITH SINGLE WIRE NETWORK CONNECTION.

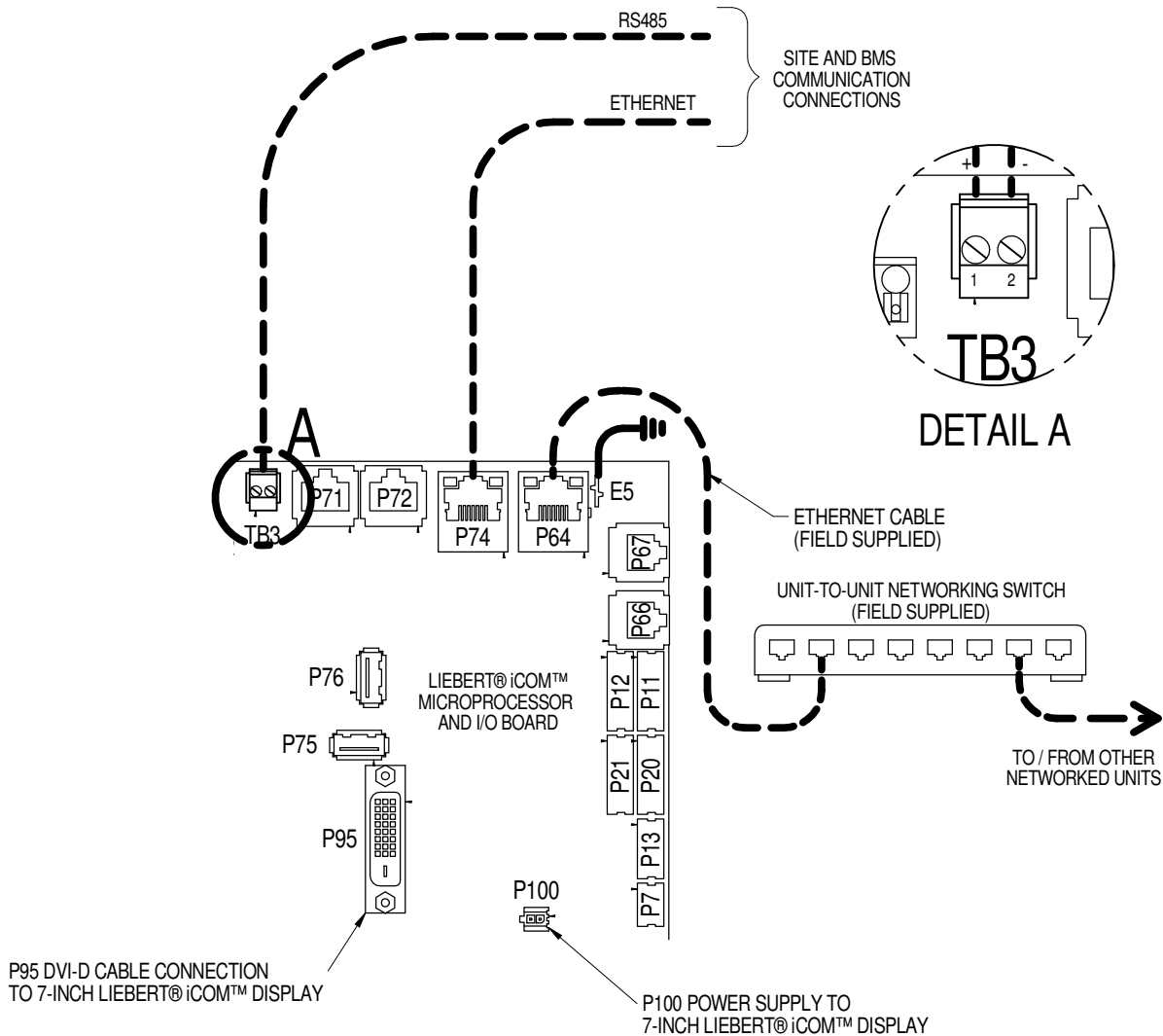



## UNIT TO UNIT NETWORK CONNECTIONS

LIEBERT® iCOM™-1 CONTROL BOARD WITH STANDARD 9 INCH COLOR TOUCHSCREEN  
 LIEBERT® iCOM™ DISPLAY WITH SINGLE WIRE NETWORK CONNECTION.

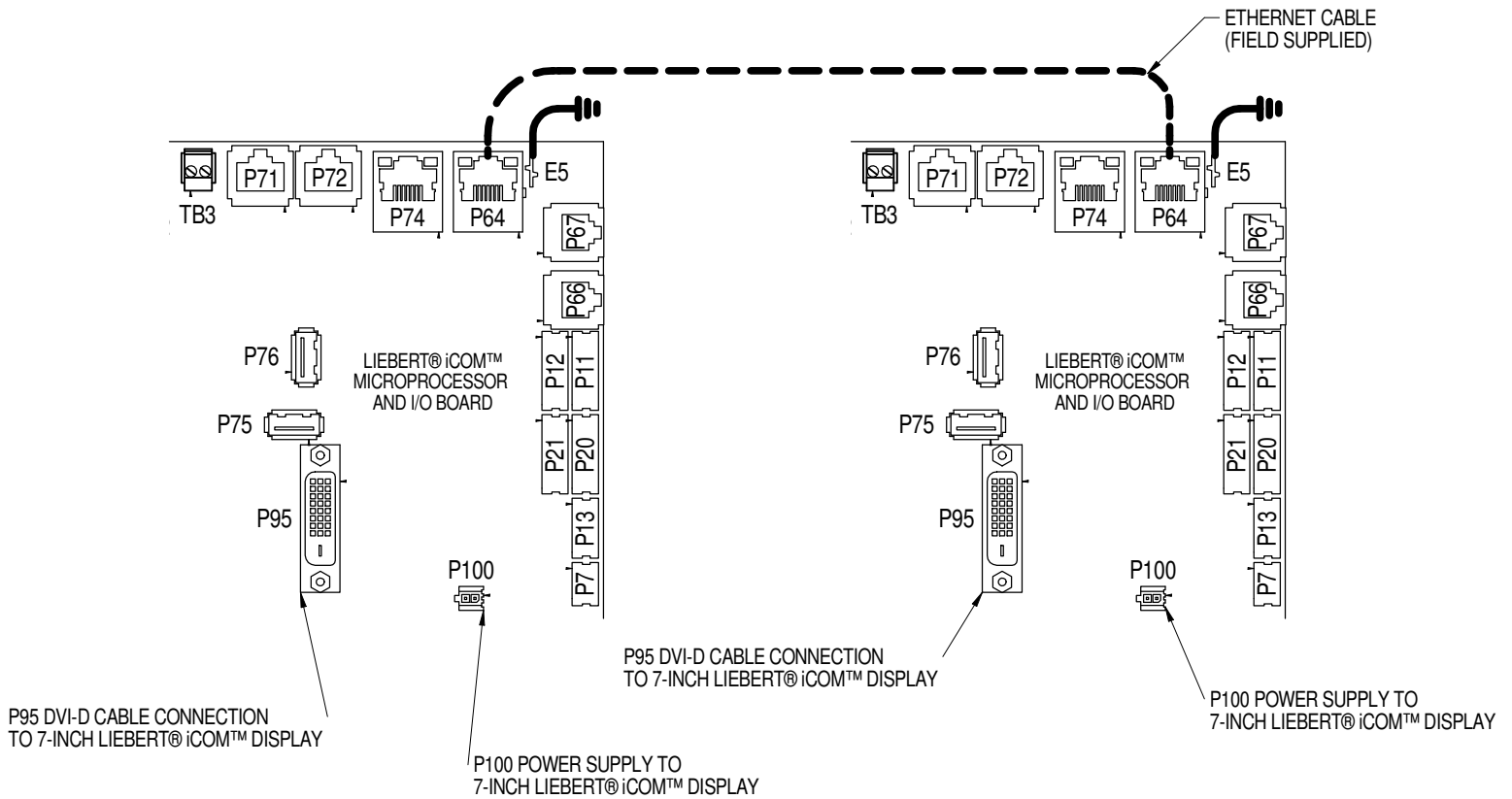

**NOTE\*** For dual-unit network configurations only

## COMMUNICATION CONNECTION DIAGRAM FOR COOLING UNITS TO LIEBERT® iCOM™-S PANEL

LIEBERT® iCOM™-1 CONTROL BOARD WITH STANDARD 9 INCH COLOR TOUCHSCREEN  
 LIEBERT® iCOM™ DISPLAY WITH SINGLE WIRE NETWORK CONNECTION.

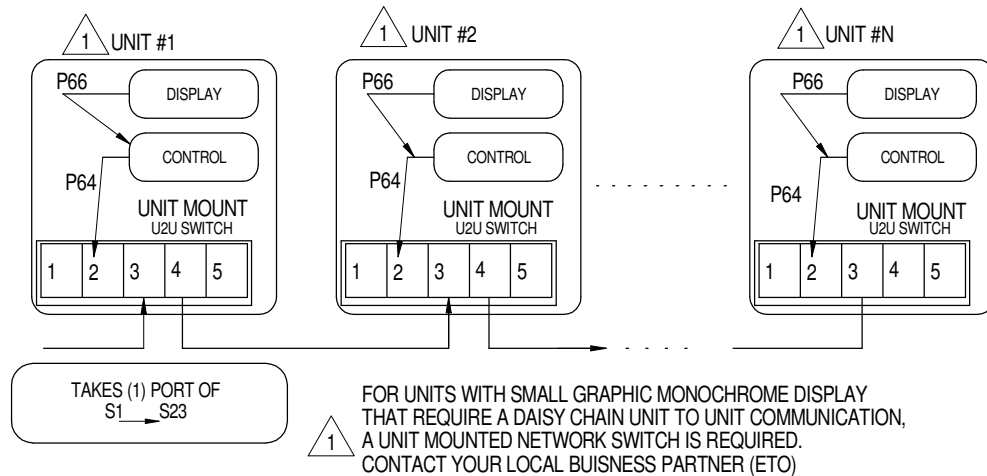
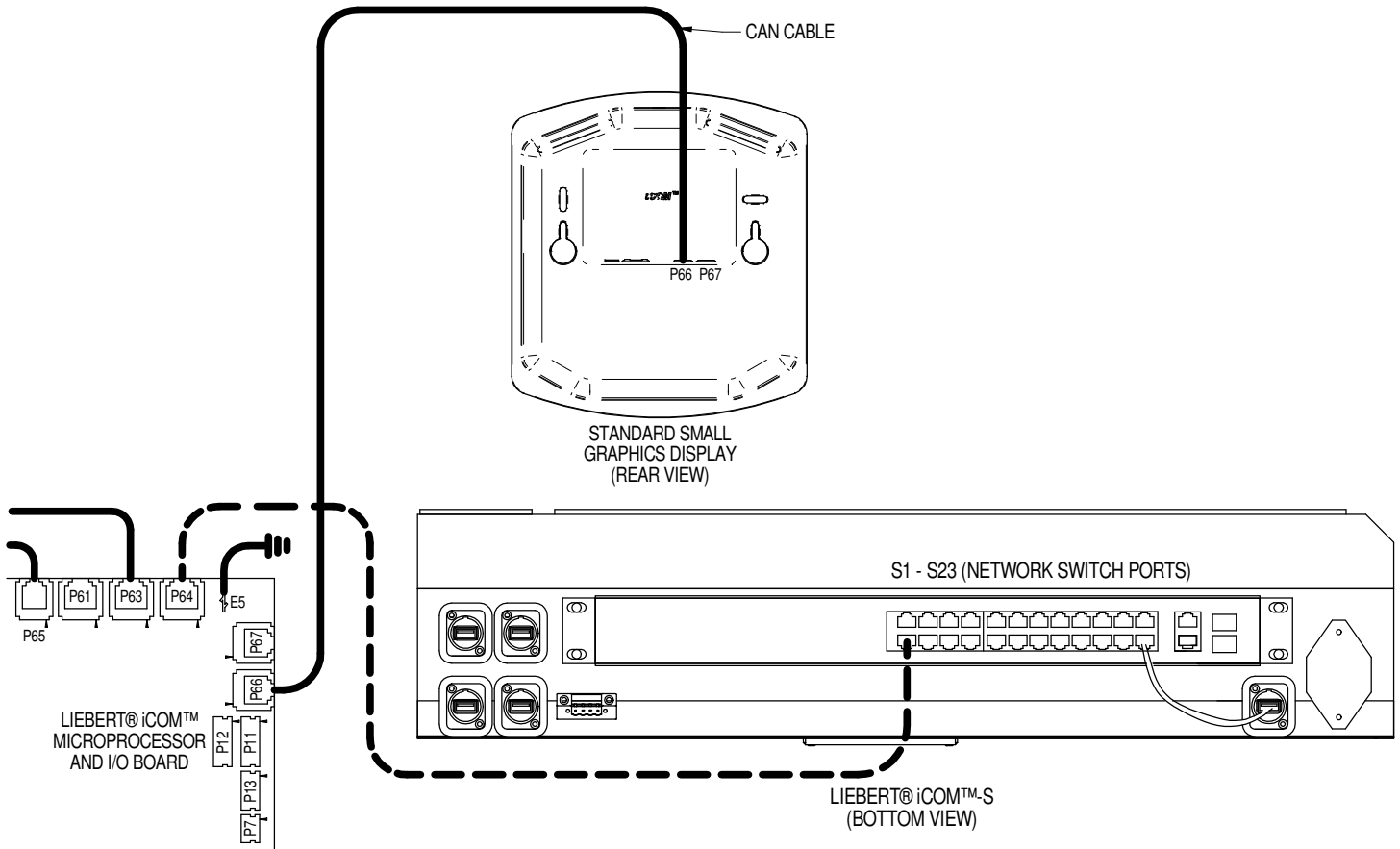

## COMMUNICATION CONNECTION DIAGRAM FOR COOLING UNITS TO LIEBERT® iCOM™-S PANEL

LIEBERT® iCOM™-1 CONTROL BOARD WITH STANDARD 9 INCH COLOR TOUCHSCREEN  
 LIEBERT® iCOM™ DISPLAY WITH SINGLE WIRE NETWORK CONNECTION.

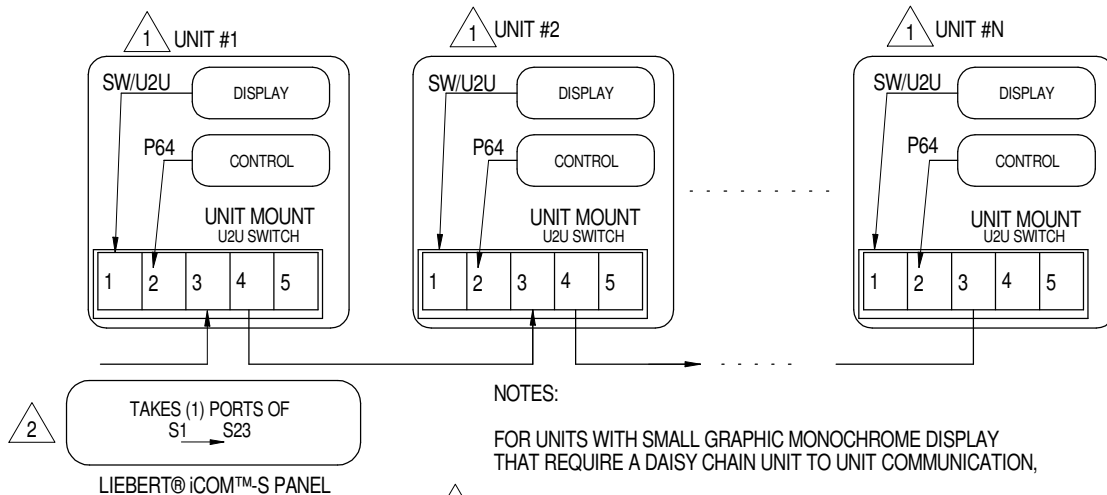
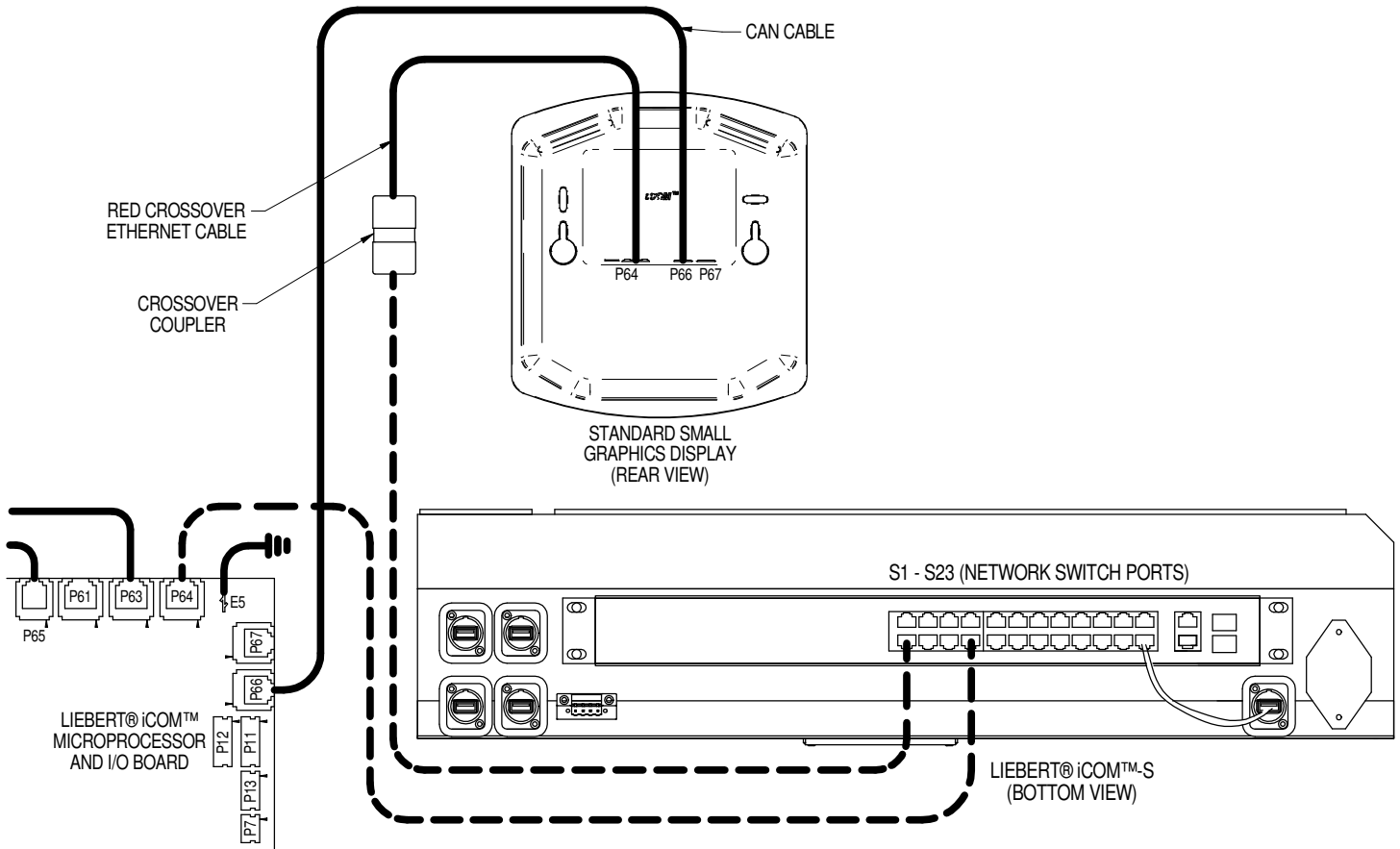

**NOTES:**

FOR UNITS WITH SMALL GRAPHIC MONOCHROME DISPLAY THAT REQUIRE A DAISY CHAIN UNIT TO UNIT COMMUNICATION,

- 1 A UNIT MOUNTED NETWORK SWITCH IS REQUIRED.
- 2 CONTACT YOUR LOCAL BUSINESS PARTNER (ETO)

## UNIT TO UNIT NETWORK CONNECTIONS

### UNIT CONFIGURATION - STANDARD W/O ETHERNET SWITCH OPTION SELECTED

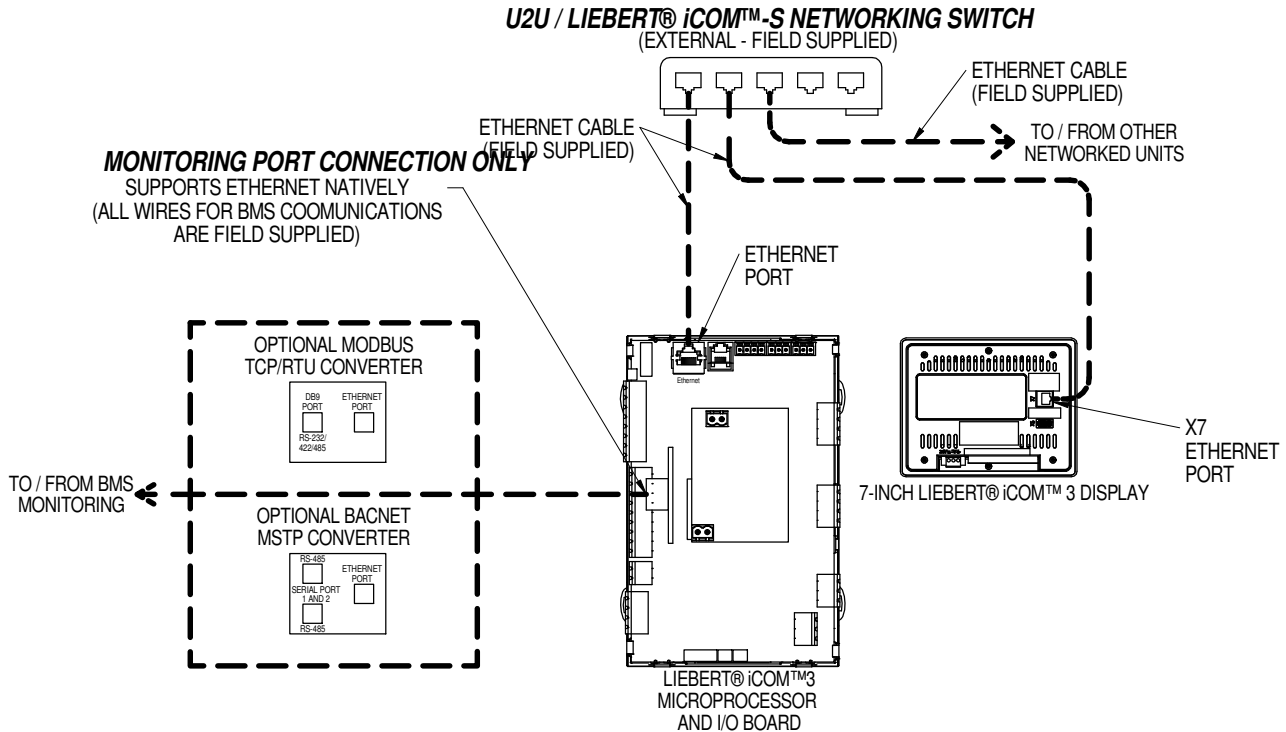

EXISTING FACTORY CABLE MUST BE REMOVED FOR UNIT TO UNIT COMMUNICATIONS.

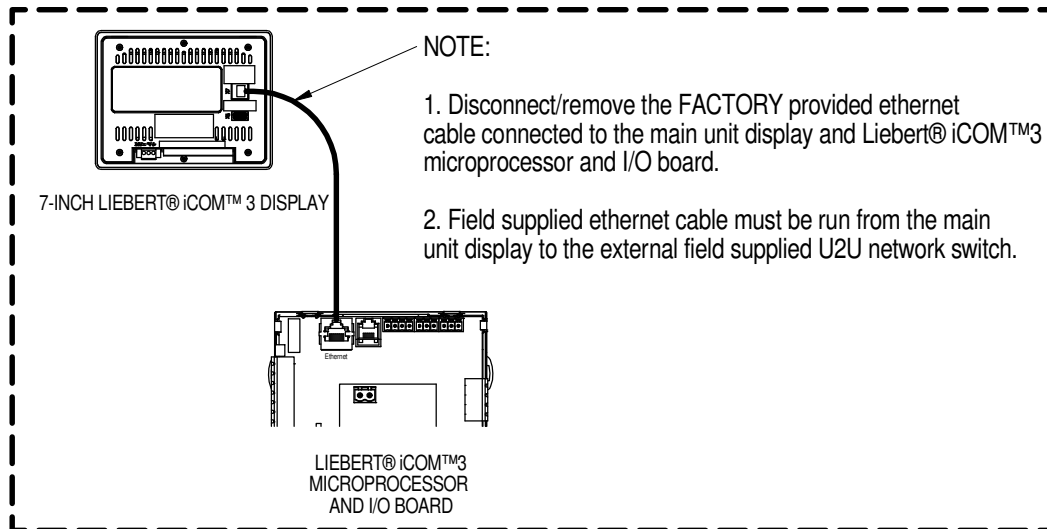

## UNIT TO UNIT NETWORK CONNECTIONS

### UNIT CONFIGURATION - INTERNAL ETHERNET SWITCH OPTION SELECTED

#### U2U / LIEBERT® iCOM™-S NETWORKING SWITCH (INTERNAL - FACTORY INSTALLED)

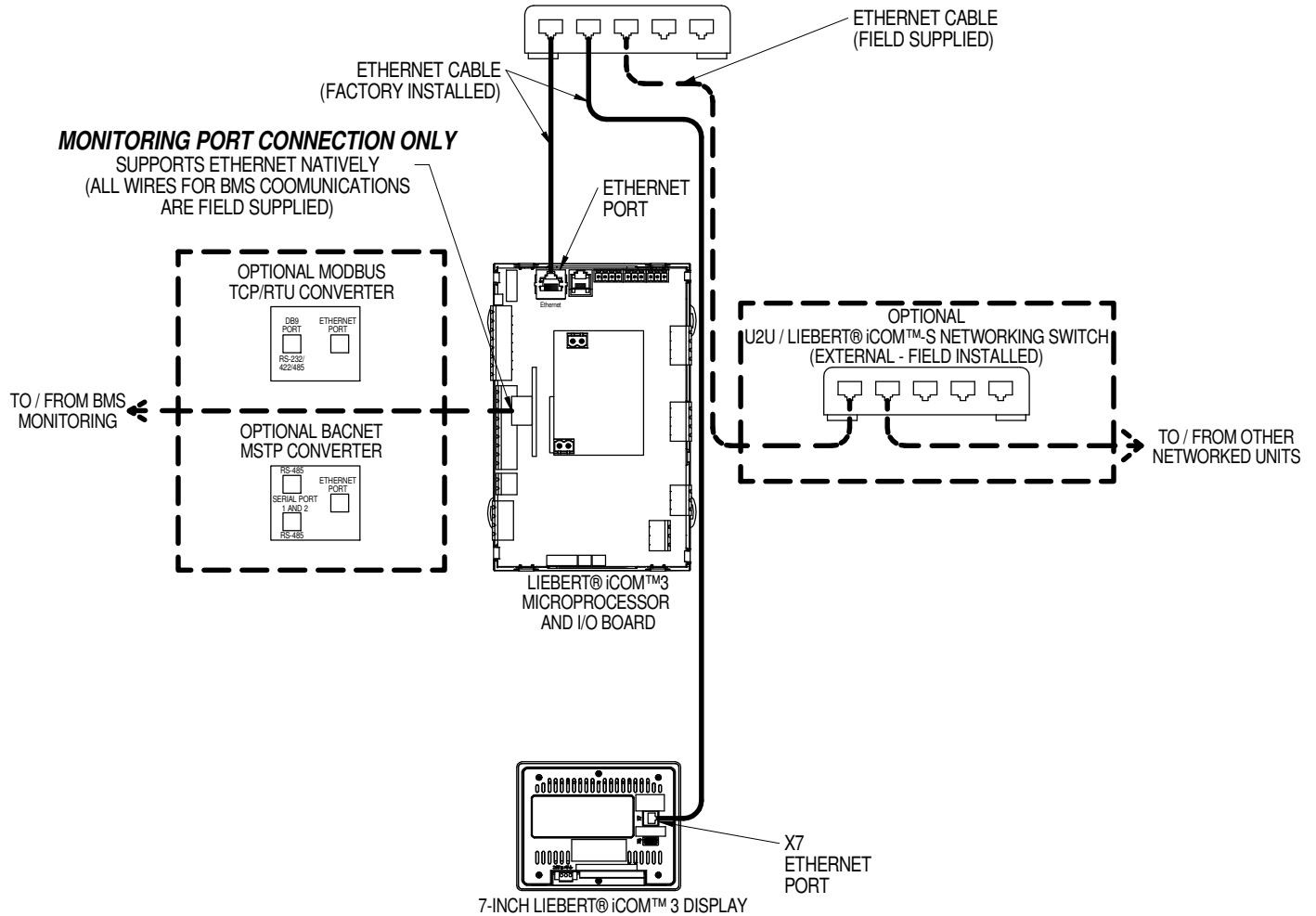

## DIMENSIONAL DATA

### VERTIV™ RDU-301 DESKTOP MOUNT

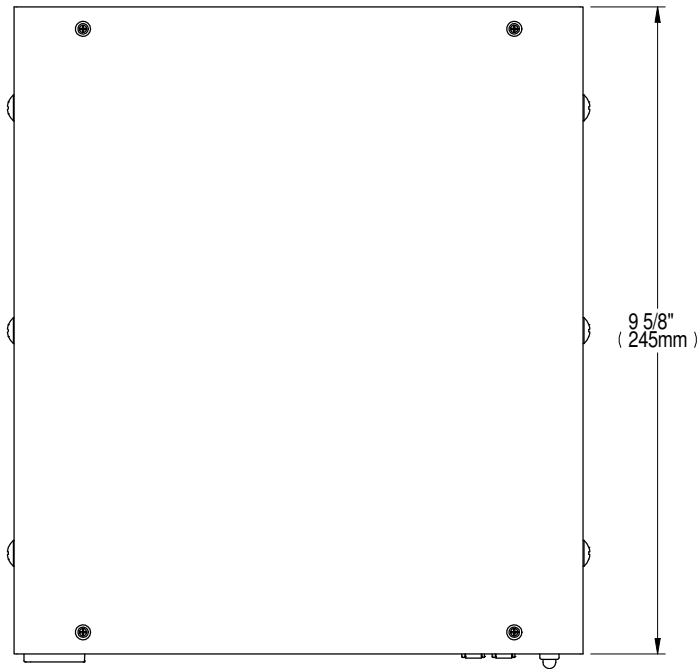

Top View

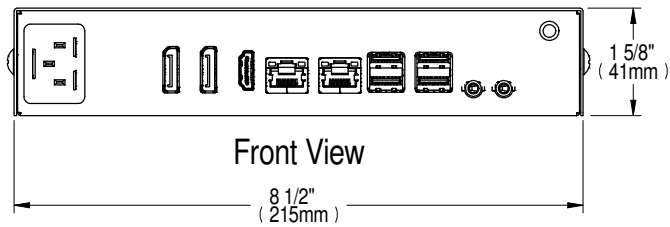
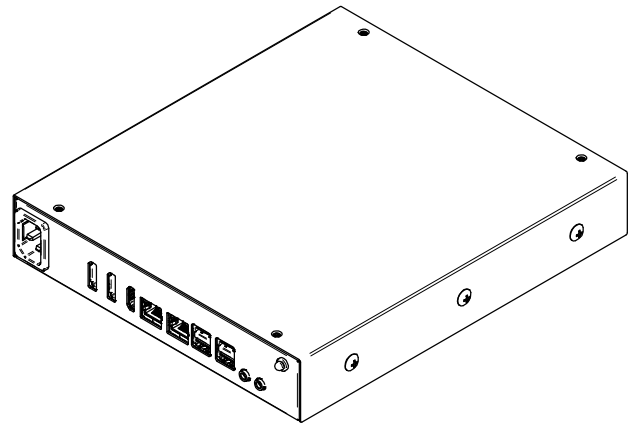

Front View

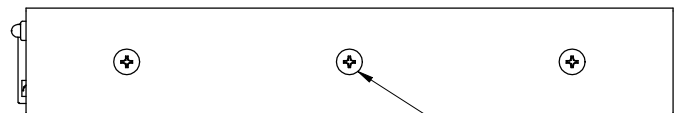

Right Side View

Mounting Screws  
Typ. (3) Each Side

Notes:

1. Weight: 6 lbs (2.7 kg) with no brackets.
2. See sheet 3 Electrical and Networking Connections for more information.

## DIMENSIONAL DATA

### VERTIV™ RDU-301 1U SHELF MOUNT

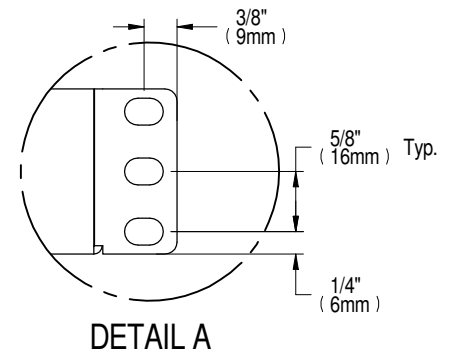
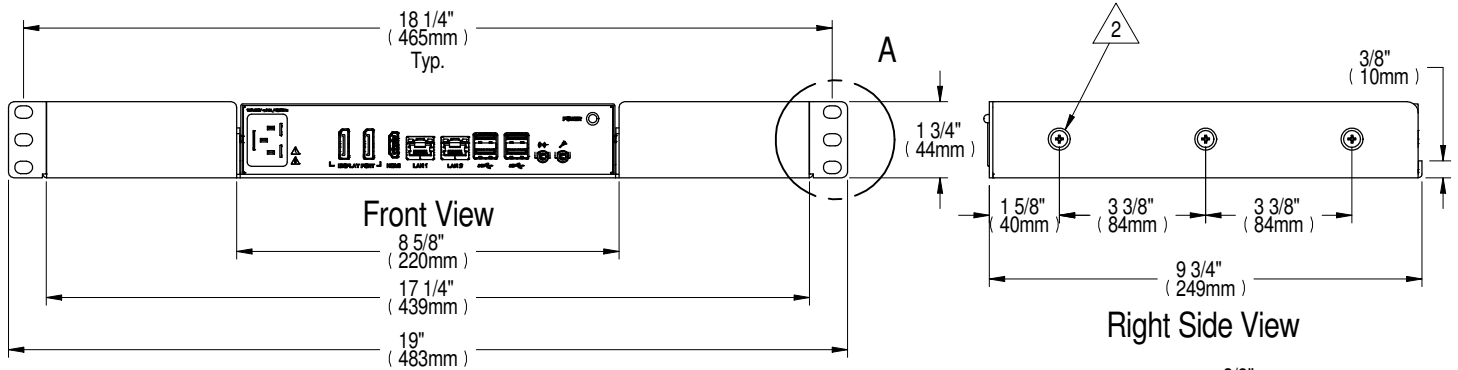
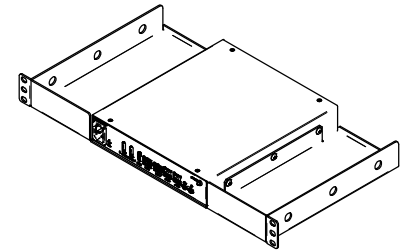
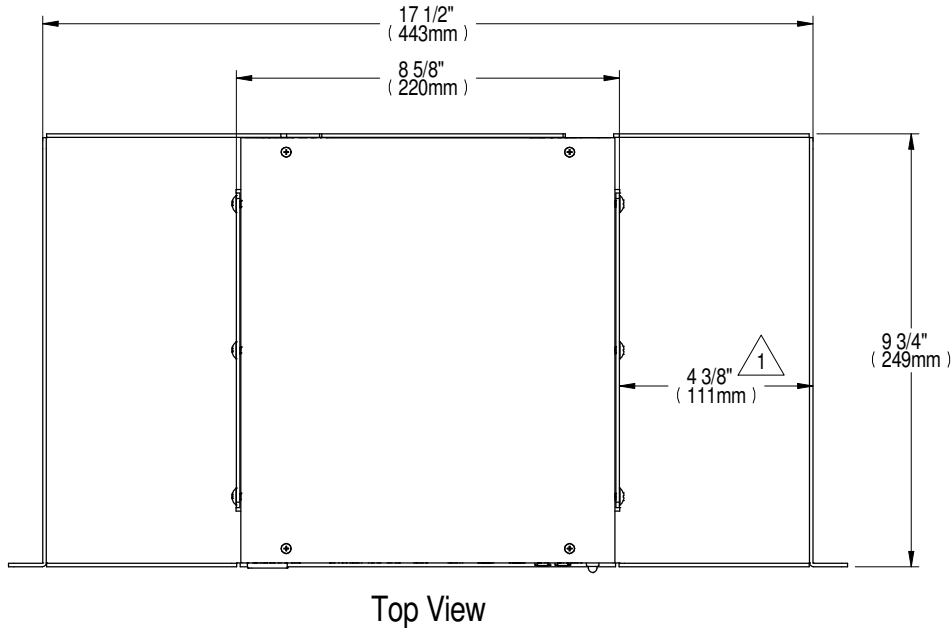

Notes:

1. Minimum length of screwdriver to be used for mounting Liebert® RDU into 1U shelf.
2. Remove (6) screws (3 from each side) and use to mount the Liebert® RDU into the 1U shelf mounting kit.

## ELECTRICAL AND NETWORKING CONNECTIONS

### VERTIV™ RDU-301

#### ELECTRICAL:

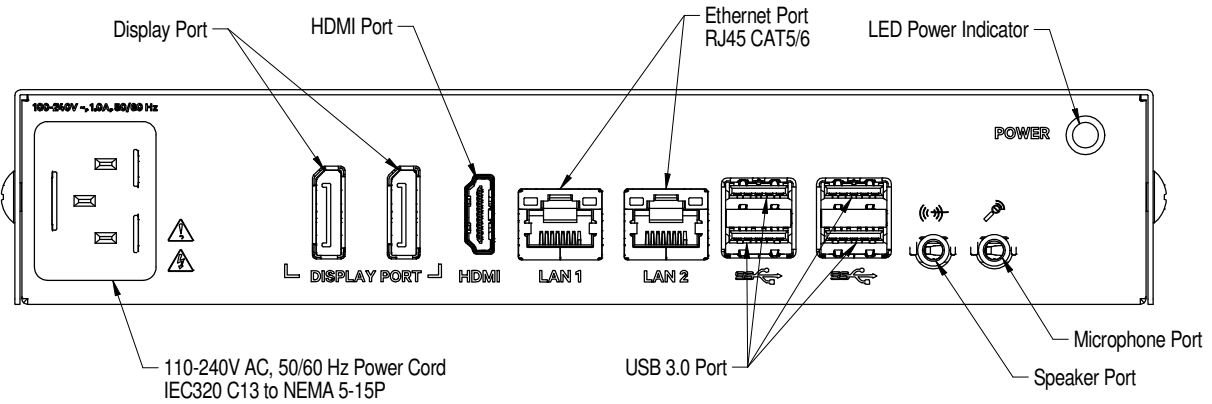

FLA: 1.5A RMS

#### NETWORKING:

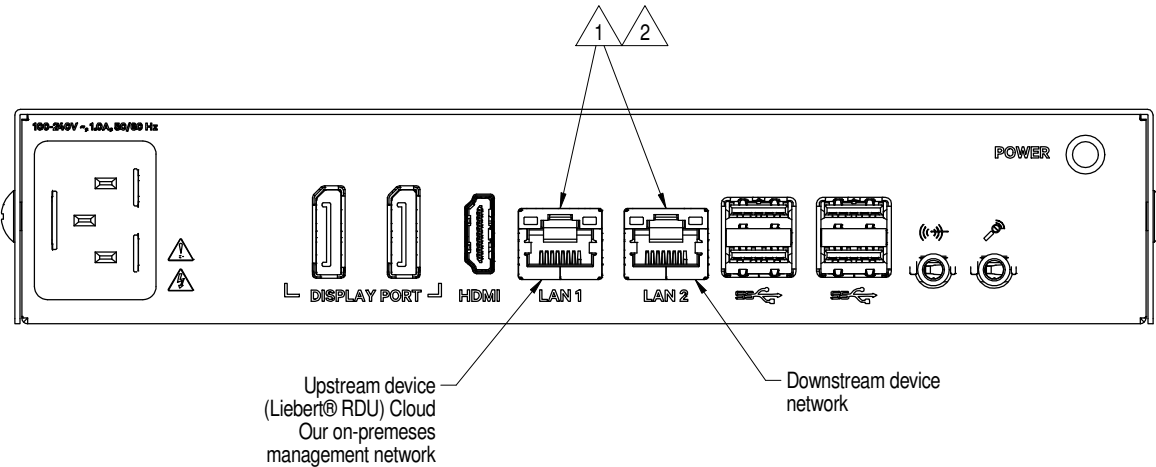

#### Notes:

1. LAN 1/2 utilize RJ45 connectors with CAT5/6 Ethernet Cables.
2. Maximum Ethernet line length = 328' (100m) without a powered repeater/switch.



## WIRELESS APPLICATION REMOTE MOUNTING KIT & ANTENNA

WIRELESS GATEWAY DIMENSIONS

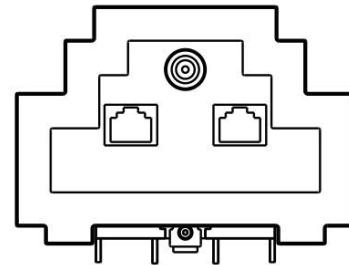
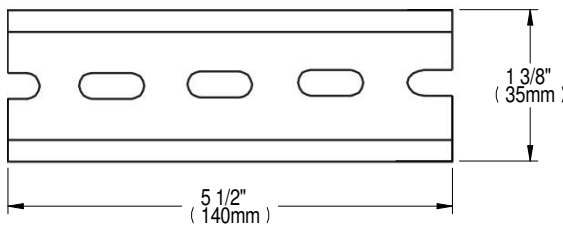
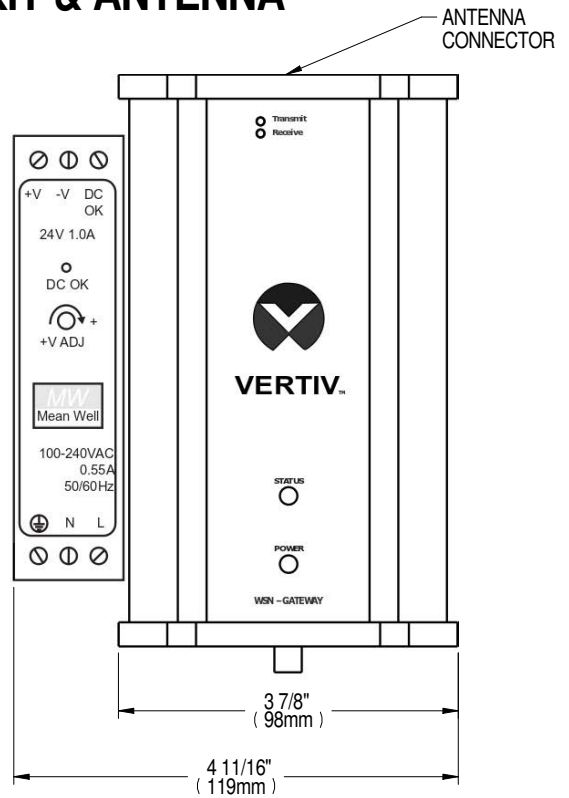
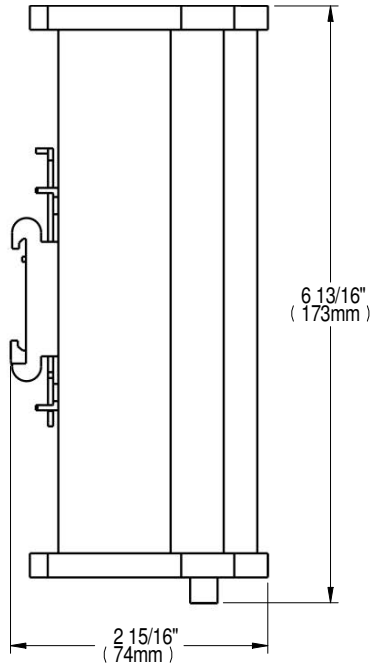

WIRELESS GATEWAY WEIGHT: 1.44 LBS.  
POWER SUPPLY WEIGHT 0.4LB  
MOUNT DIN RAIL SECURELY TO FLAT SURFACE  
THE DIN RAIL MUST BE GROUNDED IN ACCORDANCE  
WITH NATIONAL AND LOCAL ELECTRICAL CODES.  
ATTACHING THE WIRELESS GATEWAY TO THE DIN  
RAIL GROUNDS THE GATEWAY.

BASIC ANTENNA DIMENSIONS

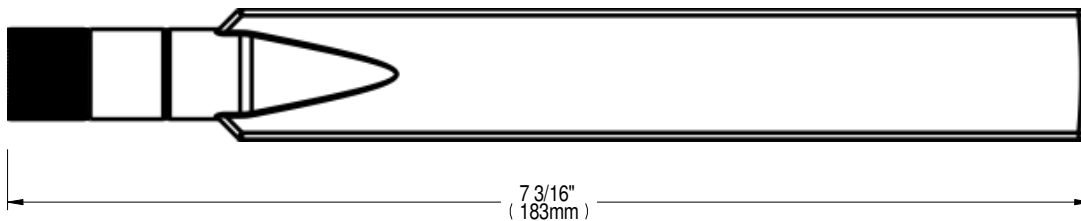

## WIRELESS APPLICATION GATEWAY - REMOTE MOUNTING KIT

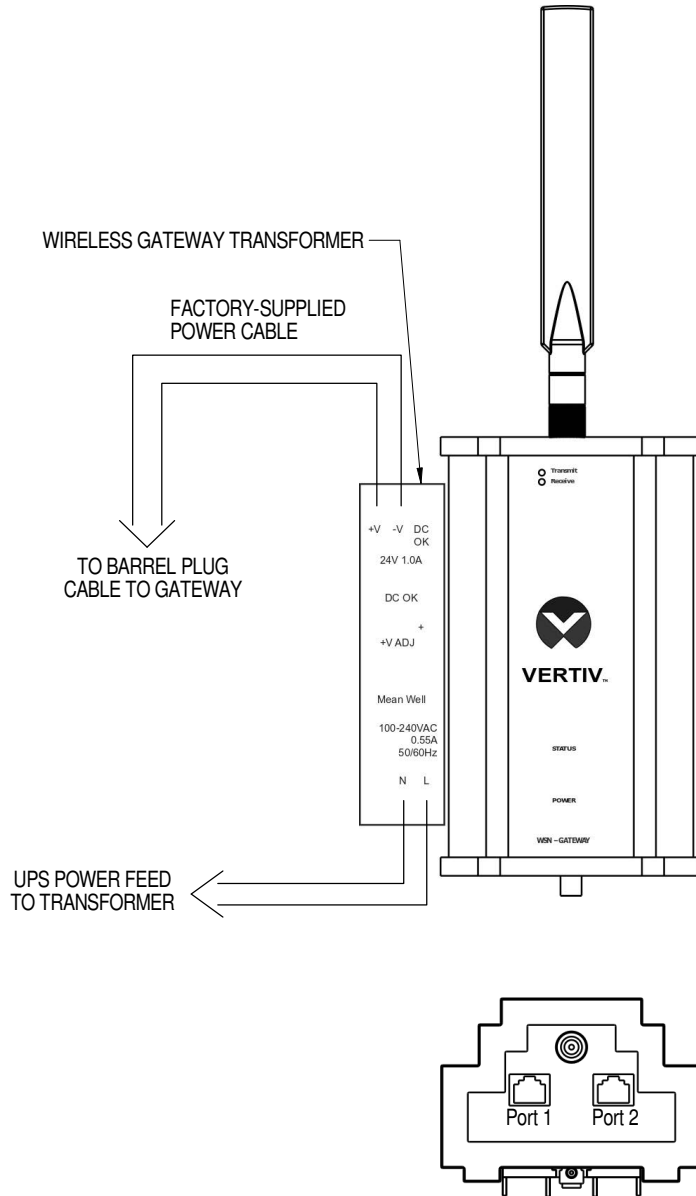

**NOTES:**

1. INPUT POWER: 85-264VAC, 0.55A @ 115VAC/0.35A@230VAC
2. NETWORK CABLE: CAT 5E OR 6E SHIELDED CABLE -MAX DISTANCE 328FT (100M)
3. VERIFY DC OUTPUT VOLTAGE AT AC TO DC TRANSFORMER AT INSTALLATION.
4. +V TO -V SHOULD READ 24V DC. TURN +V ADJ CLOCKWISE TO INCREASE VOLTAGE OUTPUT. COUNTER CLOCKWISE TO DECREASE.
5. SEE VERTIV WIRELESS NETWORK MANUAL FOR FURTHER DETAIL.

## Appendix C: Reports

Table C.1 Reports

Parameter	Instanteous?	Parameters Recorded
Control Group	No	Group Name Calculation Name Is Control Is Enabled Result Min Result Max Result Result Date UTC Resolution Types
Group Point Statistics	No	Group Name Point ID, Point Name Point Ref Type ID Point Ref Unit Category Type ID Current Reading Min Reading Max Reading Average Reading Deviation Parent ID Value Description
HVAC Current Readings	Yes	HvacUnitId HvacUnitIdentifier HvacUnitName RoomName GroupName PointName PointOriginalName PointReferenceIdentifier Value, ReadingUnitDisplayLabel Family UnitCategory

**Table C.1 Reports (continued)**

Parameter	Instanteous?	Parameters Recorded
HVAC Unit Group Statistics	Yes	Group ID Group Name Group Identifier Control Value Fallback Value Control Enabled On Off Standby Disconnected
HVAC Unit Point Statistics	No	HVAC Unit Name Point ID Point Name Point Ref Type ID Point Ref Unit Category Type ID Current Reading Min Reading Max Reading Average Reading Deviation
HVAC Unit Statistics	Yes	HVAC Unit ID HVAC Unit Name Room Name Group Name Active Alarm Count Connection Status Value Description Common Alarm Status Return Air Supply Air Return Air Set Point Supply Set Point Cooling Percentage Fan Speed Economizing Status

Table C.1 Reports (continued)

Parameter	Instanteous?	Parameters Recorded
HVAC Unit Status	No	Group Name Point ID Point Name Point Ref Type ID Point Ref Unit Category Type ID Current Reading Min Reading Max Reading Average Reading Deviation Parent Name Parent ID Value Description
HVAC Units	No	RoomName HvacUnitName PointName Initialized PointLocation RowName, PointId HvacUnitId, Reading MinReading MaxReading ReadingDateUtc ResolutionType
Point Alarm Statistics	No	Parent Name Parent ID Value Description Point Ref Unit Category Type ID Point ID Point Name Current Reading Min Reading Max Reading Average Reading Deviation

**Table C.1 Reports (continued)**

Parameter	Instanteous?	Parameters Recorded
Point Statistics	No	All Available Points ParentName ParentId Value, Description PointRefUnitCategoryTypeId PointId, PointName CurrentReading MinReading, MaxReading AverageReading, Deviation
System Diagnostics Report	Yes	
Thermal Point Statistics	No	Point Name Initialized Value Description Is Control Point Point ID Parent Name Parent ID Value Description Current Reading Gateway ID Gateway Name Gateway Online Min Reading Max Reading Average Reading Deviation Threshold Low Threshold High Reading Date UTC Value Description

**Table C.1 Reports (continued)**

Parameter	Instanteous?	Parameters Recorded
Wireless Points	No	Room Name Wireless Radio Name Point Name Initialized Point Location Point Connection Type Row Name Point ID Wireless Radio ID Reading Min Reading Max Reading Reading Date UTC

This page intentionally left blank



## Appendix D: Available BMS Points

Points Available in Liebert® iCOM™-S From EACH Unit CAN ENABLE UP TO 40 (default) OF THESE POINTS FOR EACH UNIT FOR BMS						
Area	Point	BMS Point Type	Gen 2.2.3 PA	Gen 2.2.3 CR	Gen 2.2.3 VIA	Gen 2.2.3 A9H
Alarm	C.P. High H2O	Binary Input	X	X	X	X
Alarm	CAN EEV1 Comm Error Alarm	Binary Input	X		X	X
Alarm	CAN EEV2 Comm Error Alarm	Binary Input	X		X	X
Alarm	CAN EEV3 Comm Error Alarm	Binary Input	X			
Alarm	CAN EEV4 Comm Error Alarm	Binary Input	X			
Alarm	Circuit 1 High Pressure	Binary Input	X		X	X
Alarm	Circuit 1 Low Pressure	Binary Input	X		X	X
Alarm	Circuit 2 High Pressure	Binary Input	X		X	X
Alarm	Circuit 2 Low Pressure	Binary Input	X		X	X
Alarm	Clogged Filter	Binary Input	X	X	X	X
Alarm	Common Alarm Status	Binary Input	X	X	X	X
Alarm	Compressor 1 Over Temp	Binary Input	X		X	X
Alarm	Compressor 1 Overload	Binary Input	X		X	X
Alarm	Compressor 1 Short Cycle	Binary Input	X			X
Alarm	Compressor 1A Overload	Binary Input	X		X	
Alarm	Compressor 1B Overload	Binary Input	X		X	X
Alarm	Compressor 2 Over Temp Alarm	Binary Input	X		X	X
Alarm	Compressor 2 Overload	Binary Input	X		X	X
Alarm	Compressor 2 Short Cycle	Binary Input	X			X
Alarm	Compressor 2A Overload	Binary Input	X		X	
Alarm	Compressor 2B Overload	Binary Input	X		X	X
Alarm	Compressor 3A Overload	Binary Input	X			
Alarm	Compressor 3B Overload	Binary Input	X			
Alarm	Compressor 4A Overload	Binary Input	X			
Alarm	Compressor 4B Overload	Binary Input	X			
Alarm	Condensate Pump High Water	Binary Input	X			
Alarm	Condenser 1 Communication Lost	Binary Input	X		X	X
Alarm	Condenser 2 Communication Lost	Binary Input	X		X	X
Alarm	CW Valve Hours Exceeded Alarm	Binary Input	X			
Alarm	EC Fan Failure	Binary Input	X		X	X
Alarm	EEV Unspecified	Binary Input	X			X

Points Available in Liebert® iCOM™-S From EACH Unit CAN ENABLE UP TO 40 (default) OF THESE POINTS FOR EACH UNIT FOR BMS						
Area	Point	BMS Point Type	Gen 2.2.3 PA	Gen 2.2.3 CR	Gen 2.2.3 V1A	Gen 2.2.3 A9H
Alarm	EEV1 Driver Failure	Binary Input	X		X	X
Alarm	EEV1 Motor Error	Binary Input	X			X
Alarm	EEV1 Power Failure	Binary Input	X			X
Alarm	EEV1 Unspecified	Binary Input	X		X	X
Alarm	EEV2 Driver Failure	Binary Input	X		X	X
Alarm	EEV2 Motor Error	Binary Input	X			X
Alarm	EEV2 Power Failure	Binary Input	X			X
Alarm	EEV2 Unspecified	Binary Input	X		X	X
Alarm	EEV3 Driver Failure	Binary Input	X			
Alarm	EEV3 Motor Error	Binary Input	X			
Alarm	EEV3 Power Failure	Binary Input	X			
Alarm	EEV3 Unspecified	Binary Input	X			
Alarm	EEV4 Driver Failure	Binary Input	X			
Alarm	EEV4 Motor Error	Binary Input	X			
Alarm	EEV4 Power Failure	Binary Input	X			
Alarm	EEV4 Unspecified	Binary Input	X			
Alarm	Fan Temperature Compensation Limit	Binary Input	X			
Alarm	General Compressor Overload Alarm	Binary Input	X			X
Alarm	General Fan Failure	Binary Input	X		X	X
Alarm	High Return Air Dew Point Alarm	Binary Input	X		X	X
Alarm	High Room Humidity	Binary Input	X		X	X
Alarm	High Room Return Air Temperature	Binary Input	X		X	X
Alarm	High Static Pressure Alarm	Binary Input	X			
Alarm	High Supply Temperature Alarm	Binary Input	X		X	X
Alarm	Loss of Air Flow	Binary Input	X	X	X	X
Alarm	Loss of Power	Binary Input	X			X
Alarm	Loss Of Water Flow Alarm	Binary Input	X			
Alarm	Low Return Air Dew Point Alarm	Binary Input	X		X	X
Alarm	Low Room Humidity	Binary Input	X	X	X	X
Alarm	Low Room Return Air Temperature	Binary Input	X	x	X	X
Alarm	Low Static Pressure Alarm	Binary Input	X			
Alarm	Low Supply Temperature	Binary Input	X		X	X
Alarm	Main Fan Overload	Binary Input	X			X

Points Available in Liebert® iCOM™-S From EACH Unit CAN ENABLE UP TO 40 (default) OF THESE POINTS FOR EACH UNIT FOR BMS						
Area	Point	BMS Point Type	Gen 2.2.3 PA	Gen 2.2.3 CR	Gen 2.2.3 V1A	Gen 2.2.3 A9H
Alarm	MB Valve 1 Comm Failure Alarm	Binary Input	X			
Alarm	MB Valve 2 Comm Failure Alarm	Binary Input	X			
Alarm	Pump Failure	Binary Input	X			X
Alarm	Room Sensor Failure Alarm	Binary Input	X		X	X
Alarm	Smoke Detected	Binary Input	X	X	X	X
Alarm	Standby Unit On	Binary Input	X			
Alarm	Supply Sensor Failure	Binary Input	X		X	X
Alarm	Unit Network Failure Alarm	Binary Input	X		X	X
Alarm	Valve 1 FB Failure Alarm	Binary Input	X			
Alarm	Valve 2 FB Failure Alarm	Binary Input	X			
Alarm	Water Detected	Binary Input	X	X	X	X
Humidity	Relative Humidity % of each Wired Remote TH sensor	Analog Input	X			
Humidity	Return Air Dew Point	Analog Input	X	X	X	X
Humidity	Unit Return Air Relative Humidity	Analog Input	X			
Operation	ATS Line 1 OK	Binary Input	X			
Operation	ATS Line 1 Status	Binary Input	X			
Operation	ATS Line 2 OK	Binary Input	X			
Operation	ATS Line 2 Status	Binary Input	X			
Operation	ATS Line State	Binary Input	X			
Operation	ATS Mode	Binary Input	X			
Operation	Cooling Percentage	Analog Input	X	X	X	X
Operation	Cooling Status	Binary Input	X	X	X	X
Operation	Dehumidifier Status	Binary Input	X	X	X	X
Operation	Device is Communicating (to iCOM-S)	Binary Input	X	X		X
Operation	Electric Reheat Percentage	Analog Input	X	X	X	X
Operation	Electric Reheat Status	Binary Input	X	X	X	X
Operation	Fan Control Sensor Type	Analog Output	X		X	
Operation	Fan Speed	Analog Input	X	X	X	X
Operation	Free Cooling Ramp	Analog Input	X			
Operation	Free Cooling Status	Binary Input	X	X	X	X
Operation	High Temperature Threshold	Analog Input	X		X	X

Points Available in Liebert® iCOM™-S From EACH Unit CAN ENABLE UP TO 40 (default) OF THESE POINTS FOR EACH UNIT FOR BMS						
Area	Point	BMS Point Type	Gen 2.2.3 PA	Gen 2.2.3 CR	Gen 2.2.3 V1A	Gen 2.2.3 A9H
Operation	Humidifier Status	Binary Input	X	X	X	X
Operation	Humidity Control Type	Analog Input	X	X	X	X
Operation	Individual Remote Sensors	Binary Input	X			
Operation	Instantaneous Power Consume (Watts)	Analog Input	X	X	X	X
Operation	MB 01 Connection Status	Binary Input	X			
Operation	MB 01 Energy	Analog Input	X			
Operation	MB 01 L1 - L2 Voltage	Analog Input	X			
Operation	MB 01 L1 - N Voltage	Analog Input	X			
Operation	MB 01 L1 Current	Analog Input	X			
Operation	MB 01 L2 - L3 Voltage	Analog Input	X			
Operation	MB 01 L2 - N Voltage	Analog Input	X			
Operation	MB 01 L2 Current	Analog Input	X			
Operation	MB 01 L3 - L1 Voltage	Analog Input	X			
Operation	MB 01 L3 - N Voltage	Analog Input	X			
Operation	MB 01 L3 Current	Analog Input	X			
Operation	MB 01 Voltage Type	Analog Input	X			
Operation	MB 01 Wattage	Analog Input	X			
Operation	MB Device 21	Analog Input	X			
Operation	MB Device Mode 21	Analog Input	X			
Operation	Number of Connected Units	Analog Input	X		X	X
Operation	Number of Standby Units	Analog Input	X		X	X
Operation	Return Air Humidity	Analog Input	X	X	X	X
Operation	Rotate Now	Binary Input	X		X	X
Operation	Rotation Frequency	Analog Input	X		X	X
Operation	Sensor 01 Function	Analog Input	X		X	
Operation	Sensor 02 Function	Analog Input	X		X	
Operation	Sensor 03 Function	Analog Input	X		X	
Operation	Sensor 04 Function	Analog Input	X		X	
Operation	Sensor 05 Function	Analog Input	X		X	
Operation	Sensor 06 Function	Analog Input	X		X	
Operation	Sensor 07 Function	Analog Input	X		X	
Operation	Sensor 08 Function	Analog Input	X		X	
Operation	Sensor 09 Function	Analog Input	X		X	

Points Available in Liebert® iCOM™-S From EACH Unit CAN ENABLE UP TO 40 (default) OF THESE POINTS FOR EACH UNIT FOR BMS						
Area	Point	BMS Point Type	Gen 2.2.3 PA	Gen 2.2.3 CR	Gen 2.2.3 V1A	Gen 2.2.3 A9H
Operation	Sensor 10 Function	Analog Input	X		X	
Operation	Specific Unit Status	Analog Input	X	X	X	X
Operation	Start Standby Units by High Temperature	Analog Input	X		X	X
Operation	Static Pressure Units	Binary Input	X			
Operation	Status ATS	Binary Input	X			
Operation	Status ATS Power Supply 1	Binary Input	X			
Operation	Status ATS Power Supply 2	Binary Input	X			
Operation	Teamwork Mode	Analog Input	X		X	X
Operation	Unit Is Master	Binary Input	X			
Operation	Unit Remote Sensors	Analog Input	X		X	
Operation	Unit Remote Sensors in AVG	Analog Input	X		X	
Operation	Unit Status	Binary Output	X	X	X	X
Pressure	Current System Static Pressure	Analog Input	X		X	X
Pressure	Current Unit Static Pressure	Analog Input	X		X	X
Set Point	Airflow Calibration	Analog Output	X			X
Set Point	Fan Control Type	Analog Output	X			
Set Point	Fan Deadband	Analog Output			X	
Set Point	Fan Integration Time	Analog Output	X		X	X
Set Point	Fan Proportional Band	Analog Output			X	
Set Point	Lead Lag Overlap Timer	Analog Output	X		X	X
Set Point	Maximum Fanspeed	Analog Output	X		X	X
Set Point	Minimum Fanspeed	Analog Output	X		X	X
Set Point	Remote Air Setpoint	Analog Output	X	X	X	X
Set Point	Remote Air Temperature Set Point	Analog Output	X			
Set Point	Rotate At Hour	Analog Output	X		X	X
Set Point	Rotate At Minute	Analog Output	X		X	X
Set Point	Rotate By	Analog Output	X		X	X
Set Point	Rotate Every	Analog Output	X			
Set Point	Supply Air Setpoint	Analog Output	X		X	X
Set Point	Supply Air Temperature Set Point	Analog Output	X	X		
Set Point	Temperature Control Sensor Type	Analog Output	X		X	
Set Point	Temperature Control Type	Analog Output	X			X

Points Available in Liebert® iCOM™-S From EACH Unit CAN ENABLE UP TO 40 (default) OF THESE POINTS FOR EACH UNIT FOR BMS						
Area	Point	BMS Point Type	Gen 2.2.3 PA	Gen 2.2.3 CR	Gen 2.2.3 V1A	Gen 2.2.3 A9H
Set Point	Temperature Deadband	Analog Output			X	
Set Point	Temperature Integration Time	Analog Output	X		X	X
Set Point	Unit Static Pressure Setpoint	Analog Output	X			
Temperature	Return Air Temperature	Analog Input	X	X	X	X
Temperature	Supply Air Temperature	Analog Input	X	X	X	X
Temperature	Wired Sensors 1A->10B (20 points total if equipped)	Analog Input	X	X	X	X
Points Available in iCOM™-S From EACH EMERSON Wireless Gateway CAN ENABLE UP TO 400 OF THESE POINTS FOR EACH GATEWAY FOR BMS*						
Area	Point					
Temperature	300 Temperature Sensors (from 100 Wireless Radios)	Analog Input				
Battery	100 Wireless Radio Battery Voltages	Analog Input				
Points Available in iCOM™-S From EACH VERTIV Wireless Sensor Connected						
Area	Point					
Temperature	Temperature Value	Analog Input				
Humidity	Relative Humidity Value	Analog Input				
Battery	Battery Voltage	Analog Input				
Signal	RSSI - dBm	Analog Input				
Signal to Noise	SNR - dB	Analog Input				
Operation	External Battery Voltage Present (ext. Battery Pack Active)	Binary Input				
Operation	Device is Communicating	Binary Input				
Operation	Motion	Binary Input				
Calculation Results Available From the Site CAN SELECT/ENABLE UP TO 5 OF THESE POINTS FOR iCOM™-S/BMS*						
	Site Cold Aisle Temperature	Analog Input				
	Site CFM Used (%)	Analog Input				
	Site CFM/kW	Analog Input				
	Site Capacity Used (%)	Analog Input				
	Site HVAC Power (kW) *if units equipped with kW meters	Analog Input				
	Site Capacity (kW) - Net Sensible	Analog Input				
	Site CFM	Analog Input				
	Site CFM Available	Analog Input				

<b>Points Available in Liebert® iCOM™-S From EACH Unit</b>						
<b>CAN ENABLE UP TO 40 (default) OF THESE POINTS FOR EACH UNIT FOR BMS</b>						
<b>Area</b>	<b>Point</b>	<b>BMS Point Type</b>	<b>Gen 2.2.3 PA</b>	<b>Gen 2.2.3 CR</b>	<b>Gen 2.2.3 V1A</b>	<b>Gen 2.2.3 A9H</b>
	Site Efficiency *if units equipped with kW meters	Analog Input				
	Site Hot Aisle Temperature	Analog Input				
	Wireless Infrastructure Alarm	Binary Input				
	High Temperature Alarm	Binary Input				
<b>Calculation Results Available From EACH Room</b>						
<b>CAN SELECT/ENABLE UP TO 5 OF THESE POINTS FOR iCOM™-S/BMS*</b>						
	Room Capacity (kW)	Analog Input				
	Room Average Cold Aisle Temperature	Analog Input				
	Room CFM Used (%)	Analog Input				
	Room Capacity Used (%)	Analog Input				
	Room HVAC Power (kW) *if units equipped with kW meters	Analog Input				
	Room CFM	Analog Input				
	Room CFM/kW	Analog Input				
	Room CFM Available	Analog Input				
	Room Efficiency *if units equipped with kW meters	Analog Input				
	Room Weighted Average Unit Supply Temperature	Analog Input				
	Room Weighted Average Unit Return Temperature	Analog Input				
	Room Weighted Average Unit dT (across coils)	Analog Input				
	Room Hot Aisle Temperature	Analog Input				
	Room Dew Point	Analog Input				
	Room Minimum Cold Aisle	Analog Input				
	Room Maximum Cold Aisle	Analog Input				
	Room Static Pressure	Analog Input				
	Room Average Relative Humidity	Analog Input				
	Wireless Infrastructure Alarm	Binary Input				
	High Temperature Alarm	Binary Input				
<b>Calculation Results Available From EACH Unit</b>						
<b>CAN SELECT/ENABLE UP TO 3 OF THESE POINTS FOR iCOM™-S/BMS*</b>						
	Unit dT (across coil)	Analog Input				
	Unit Capacity (kW)	Analog Input				
	Unit CFM	Analog Input				
	Unit Capacity Used (%)	Analog Input				
	Unit CFM/kW	Analog Input				

Points Available in Liebert® iCOM™-S From EACH Unit CAN ENABLE UP TO 40 (default) OF THESE POINTS FOR EACH UNIT FOR BMS						
Area	Point	BMS Point Type	Gen 2.2.3 PA	Gen 2.2.3 CR	Gen 2.2.3 V1A	Gen 2.2.3 A9H
	Unit CFM Used (%)	Analog Input				
	Unit Efficiency *if units equipped with kW meters	Analog Input				
<b>Calculation Results Available From EACH iCOM™ Group of Units CAN SELECT/ENABLE UP TO 4 OF THESE POINTS FOR iCOM™-S/BMS*</b>						
	Group HVAC Power (kW) *if units equipped with kW meters	Analog Input				
	Group Hot Aisle	Analog Input				
	Group Efficiency *if units equipped with kW meters	Analog Input				
	Group Cold Aisle Temperature	Analog Input				
	Group CFM Used (%)	Analog Input				
	Group CFM/kW	Analog Input				
	Group CFM Available	Analog Input				
	Group CFM	Analog Input				
	Group Capacity Used (%)	Analog Input				
	Group Capacity (kW)	Analog Input				
	Group Weighted Average Unit dT (across coil)	Analog Input				
	Group Weighted Average Unit Supply Temperature	Analog Input				
	Group Weighted Average Unit Return Temperature	Analog Input				
	Group Average Dew Point	Analog Input				
	Group Minimum Cold Aisle	Analog Input				
	Group Maximum Cold Aisle	Analog Input				
	Group Average Static Pressure	Analog Input				
	Group Average Relative Humidity	Analog Input				





---

Vertiv.com | Vertiv Headquarters, 505 N. Cleveland Ave., Westerville, OH 43082, USA

© 2024 Vertiv Group Corp. All rights reserved. Vertiv™ and the Vertiv logo are trademarks or registered trademarks of Vertiv Group Corp. All other names and logos referred to are trade names, trademarks or registered trademarks of their respective owners. While every precaution has been taken to ensure accuracy and completeness here, Vertiv Group Corp. assumes no responsibility, and disclaims all liability, for damages resulting from use of this information or for any errors or omissions.

SL-18837\_Rev9\_06-24