



**DISCONTINUED
PRODUCT**

POWER PROTECTION

Datawave[®]

TECHNICAL DATA MANUAL



*Magnetic
Synthesizer*



**DISCONTINUED
PRODUCT**

TABLE OF CONTENTS

POWER CONDITIONING, DISTRIBUTION, CONTROL AND MONITORING FOR ANY COMPUTER SITE	1
DEPENDABLE POWER FOR COMPUTER-DEPENDENT OPERATIONS	2
ADVANTAGES THAT ADD UP TO COMPUTER-GRADE POWER YEAR AFTER YEAR	3
OPERATIONAL DESCRIPTION	4
APPLICATIONS GUIDELINES	5
Paralleling Units	7
Beyond Power Conditioning: Harmonic Isolation	7
STANDARD FEATURES FOR ALL SYSTEMS	8
OPTIONAL FEATURES FOR ALL SYSTEMS	9
SITE MONITORING	11
Power Monitor Panel	11
Basic Temperature Monitoring Panel	11
SiteScan	12
AVAILABILITY	12
SYSTEM SIZING	13
PHYSICAL AND ELECTRICAL DATA	14
Operational Characteristics	14
Electrical Characteristics	15
Heat Output	16
Physical and Mechanical Characteristics	17
Service Access and Clearance Requirements	18

**POWER CONDITIONING, DISTRIBUTION, CONTROL AND MONITORING FOR ANY
COMPUTER SITE**



15-30 kVA



50-75 kVA



100-125 kVA

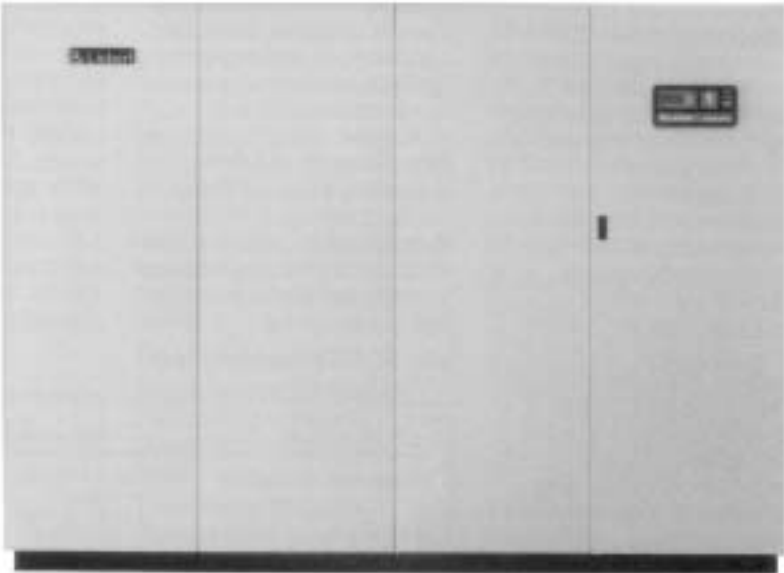

150-200 kVA

DEPENDABLE POWER FOR COMPUTER-DEPENDENT OPERATIONS

The Liebert Datawave magnetic synthesizer provides cost effective power conditioning and protection for mainframes, minicomputers, and other electronic equipment requiring stable, noise-free power.

The patented Datawave magnetic synthesis process is the most dependable power conditioning technology available.

Rugged components, including key circuit elements specially manufactured by Liebert, assure an extremely long service life.

The Datawave power conditioner has the grounding and conditioning features demanded by today's computer systems.

Computers, as well as a variety of electronic equipment in business use today, require clean stable power.





Typical electrical supply specifications are:

- **Voltage:** $\pm 5\%$
- **Frequency:** ± 0.5 Hz
- **Sags/Swells:** $\pm 10\%$ of nominal voltage
- **Transients:** Less than 50 volts in magnitude (impulses from 0.5 to 800 microseconds).

Weather extremes, storms, accidental faults, momentary overloads, and even normal operation of electrical equipment can disturb power supplied by the utilities.

Resulting sags, swells, transients and noise, while sometimes not noticeable in lighting and other noncritical electricity uses, can cause out-of-spec conditions, interruption of operations, and loss of data.

The chart below illustrates types of disturbances and their potential effect on operations.

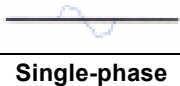
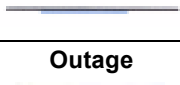
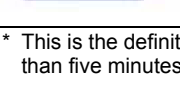
Power Conditions	Definitions	Causes	Possible Computer Symptoms
Common mode disturbances 	Impulses and EMI/RFI noise with respect to ground superimposed on the power conductors. Amplitude—Millivolts to several volts for noise; hundreds of volts for impulses	Radio transmission; Normal computer operation; Arcing contacts; Lightning; Poor grounding and shielding.	Incorrect data transfer from CPU to disk or tape; Terminal or printer errors; Input/output hardware damage; Power supply damage.
Normal mode noise 	Low level signals superimposed on the power sinewave. Amplitude—0.5 V to 25 V	Normal computer operation; Switching power supplies; Power line modulation equipment (i.e., Simplex™ clocks); Motor speed controllers.	Processing errors; Incorrect data transfer from CPU to memory; Printer or terminal errors.
Normal mode impulses & ringing transients 	Typically a narrow, fast-rise voltage variation. Can be followed by a damped oscillation decaying to nominal in less than one cycle. Amplitude—50 V to 6 kV Duration—0.5 μ sec to 2000 μ sec	Switching loads on or off; Normal computer operation; Utility switching; Lightning.	Incorrect data on disks or tapes; Processing errors; Printer or terminal errors; Hardware damage.
Sags 	A low-voltage condition on one or more phases. RMS voltages below 80-85% of nominal. Duration—Greater than 1 cycle	Ground faults; Starting large loads; Inadequate power system capacity; Utility switching; Utility equipment failure; Lightning.	Computer system crashes; Hardware damage.
Swells 	A high-voltage condition on one or more phases. Voltages above 110% of nominal. Duration—Greater than 1 cycle	Rapid load reduction; Utility switching.	Hardware damage.
Waveform distortion 	A deviation from a true voltage sinewave.	Motor speed controllers; Computer operation; Other nonlinear loads.	Communication errors; Hardware damage.
Single-phase outage 	Loss of a phase on a polyphase system.	Fuse failure; Ground faults; Equipment failure; Accidents; Utility equipment failure; Lightning; Acts of nature.	System crashes; Hardware damage.
Outage 	A zero-volt condition lasting longer than a half-cycle.*	Ground faults; Equipment failure; Utility equipment failure; Lightning; Acts of nature.	System crashes; Hardware damage.

* This is the definition of "outage" as seen by most computers. Utility companies usually define outage as a zero-volt condition lasting longer than five minutes.

ADVANTAGES THAT ADD UP TO COMPUTER-GRADE POWER YEAR AFTER YEAR

Several varieties of technologies have been applied to correct these disturbances—with varying degrees of success. Motor generator sets and line voltage regulators provide protection from some variations, but can have their own ability to supply computer grade power hampered by some electrical problems.

Datawave offers protection from a wider range of power problems, maintaining voltage within specification and isolating equipment from potentially damaging variations and transients.

Engineered for Inherent Dependability

Datawave's rugged simplicity ensures years of reliable operation, providing clean, stable power for decades. Equally important, the Datawave magnetic synthesizer regulates power without delicate electronic controls, high-power semiconductors, maintenance dependent mechanical drives or rotating parts.

Designed for Efficiency

Datawave's efficiency of 93%, along with nearly unity power factor, lowers utility costs.

Limitless Future Capacity

Datawave CA models, from 30 kVA up, can be paralleled to increase capacity by simply wiring them together.

Load sharing is automatic. Each Datawave supplies its rated amount of power.

Built to Handle Computer Current Requirements

Because of Datawave's low output impedance, nonlinear current demands of modern computers are supplied with ease. Short-term currents up to 200% of the unit's capacity can be delivered.

Transient Protection

The rugged Datawave design withstands high energy transients without passing them along to computer equipment. The Datawave easily meets ANSI C62.41 and C62.45.

Precise Voltage Regulation

Sags and swells to $\pm 40\%$ are minimized to well within computer requirements.

Input Phase Loss and Unbalance Protection

Shorting, opening, or unbalance of an input phase, which typically causes motors to overheat or drop off-line, has minimal effect on Datawave operation. The waveform synthesis network continues to supply 3-phase computer grade power.

Balancing Unbalanced Loads

Even 100% unbalanced loading of the Datawave does not cause a significant change in output voltage. Variations in output are held to + 5%, -2%.

Load Generated Noise Filtering

Output impedance of the Datawave decreases with frequency, allowing the attenuation of load-generating noise, and impulses which could otherwise affect other devices.

Input Current Distortion

The Datawave absorbs harmonic currents generated by non-linear loads. The input current distortion is less than 8% THD, independent of load current distortion.

Built-In Distribution

Depending on application requirements, Datawave can be supplied with a custom distribution system, featuring easily-changeable flexible, shielded, liquid-tight distribution cables, individually protected panelboards and separate branch circuit breakers.

	Datawave	M/G Set	LVR
Sag of 40%	-5%	Frequency out of spec at 20%	Voltage out of spec
Swell of 40%	+5%	Out of spec	Voltage out of spec
Output Harmonic Distortion	Less than 4%, total	Less than 4%, total	Typically 1% additive to input distortion
Overload	150% for 20 min.	150% for 1 min.	200% for 1 min.
Power Efficiency	Full load, 93% 3/4 load, 91.5% 1/2 load, 89%	Full load, 87% 3/4 load, 88% 1/2 load, 85%	Full load, 96% 3/4 load, 96% 1/2 load, 96%
Input Power Factor	Approaches unity	0.7 to 0.8 lagging	Reflects load power factor
Paralleling Capability	Unlimited	Complicated or not possible	Not possible

OPERATIONAL DESCRIPTION

The Datawave magnetic synthesizer is an electromagnetic, 3-phase AC power regenerator. Output waveforms are generated by combining pulses from saturating transformers.

Three areas of regeneration enable Datawave to eliminate virtually all power line disturbances, including momentary interruptions from static switching:

- (1) Energy input transfer
- (2) Waveform building
- (3) Energy storage/output

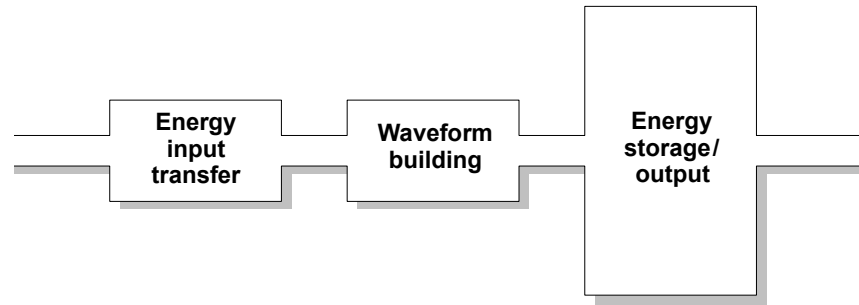

Energy Input Transfer

Input power is supplied through nonlinear chokes specially designed to provide current to the transformers independent of widely varying input voltage levels and waveform. This energy transfer technique virtually eliminates line noise and the effects of sags and swells. This current powers the waveform building circuits.

Waveform Building

Six interconnected saturating transformers construct the waveforms, with each transformer producing a distinct voltage pulse. Transformer geometry and construction determine the amplitude and duration of the pulses, and interconnecting circuitry combines these pulses into waveforms.

Energy Storage/Output

As integral elements of the interconnecting circuitry capacitors also help control the saturating sequence. Energy is dynamically stored as current in the saturated transformers, and as voltage in the capacitors. This constantly alternating energy ensures hard saturation of the transformers, precise pulse regulation and a clean, stable waveform with less than 4 percent total harmonic distortion.

Three-phase power is supplied to the load through a zig-zag transformer. This configuration maintains 120° phase separation, establishes the output-circuit neutral, and assists line-to-neutral voltage regulation. The output-circuit, including the neutral, is totally isolated from input power.

This unique design results in:

- Reliable operation and long life
- Accurate voltage regulation
- Clean waveform, independent of input
- High subcycle surge and safe steady-state overload protection to 300 percent of nominal
- Line-side and load-side noise suppression

About Saturation:

Inductors normally act as high-impedance circuits, supporting voltage. However, as the inductor core becomes saturated, current increases and voltage decreases. At saturation, regardless of polarity the inductor resembles a short-circuit.

Current is high, and the voltage is near zero. If voltage across this saturated core is reversed, it again acts as an open circuit until saturated in the reversed direction, when it again becomes a short-circuit.

About Synthesis:

At any moment during operation, five of the six transformer cores are saturated, acting as short-circuits. The sixth is then saturated, and the voltage across it collapses. The sixth then reverses the voltage across the next core in the configuration, producing an unsaturated condition. As this core saturates, it reverses the voltage across still another core. This sequential switching of transformer cores produces a series of precisely defined voltage pulses used as output waveform building blocks.

Transformer windings are primary-over-secondary, isolated with electrostatic shields for rejection of common-mode noise. An advantage of this configuration is that any broken circuit connection will not cause voltage supplied to the load to exceed specification.

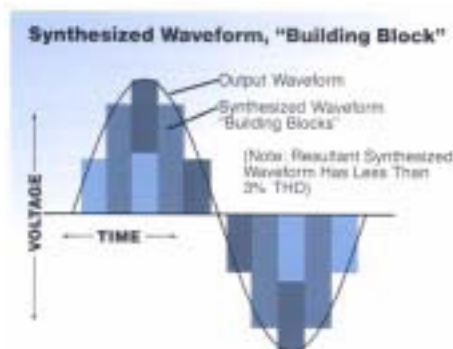

APPLICATIONS GUIDELINES

A Datawave power conditioning system is available for almost any application.

Model SC Datawave Magnetic Synthesizer

A Complete System in a Single Package:

- Full Conditioning
- Monitoring and Alarm Capabilities
- Integral Branch Circuit Distribution
- Flexible Distribution Cables



Model CA Datawave Magnetic Synthesizer

The Key Building Block:

- The foundation for basic Datawave power conditioning systems

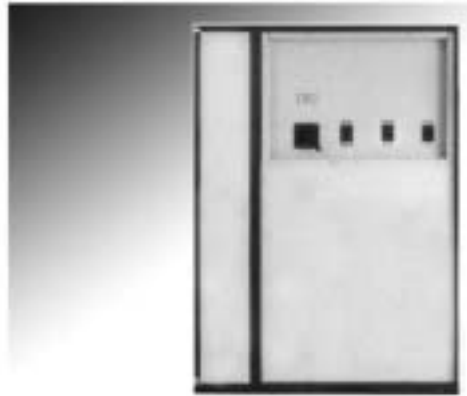

A Datawave system can be configured for practically any site.

For Existing Distribution

The Model CA can be installed to provide full conditioning capabilities in front of an existing distribution panelboard. It can also be used in old or new installations where rigid conduit is specified for distribution.

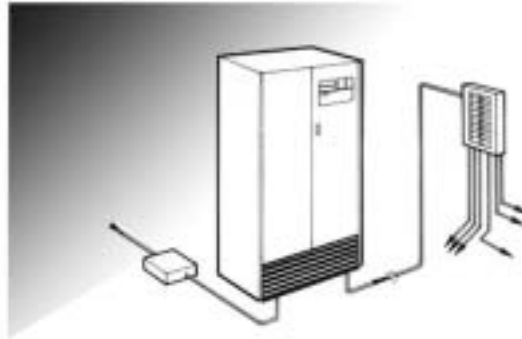

The Model CA, teamed with a separate distribution module (i.e., Liebert Precision Power Center), solves the distribution problem when the conditioning module is not installed within the computer room.

Remote Distribution

- Used where the distance between distribution and conditioning modules is 100 ft (30 m) or less.
- Voltage step-down (if required) is performed by the conditioning module.
- Feeder between modules carries conditioned power at the utilization voltage level (typically 120/208 volts 3-phase).
- Distribution module performs distribution monitoring and control functions at point-of-use.

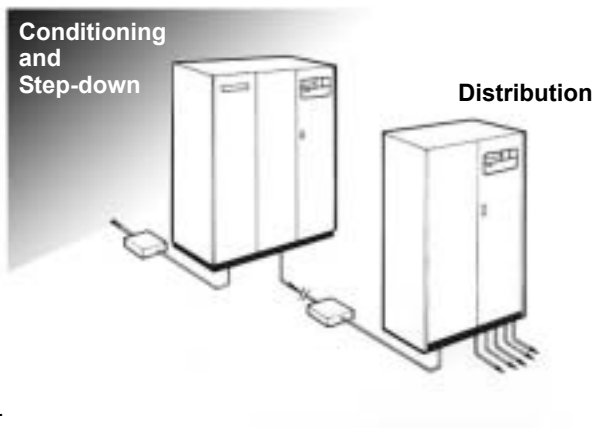

Remote Step-Down/Distribution

- Used where feeder distance between modules is between 100 and 300 feet (30 and 92 meters). If feeder distance between modules exceeds 300 feet (92 meters), consult factory.
- Decreases power loss and allows use of smaller conductors and conduits between modules.
- Voltage is not stepped down in the conditioning module.
- Feeder between modules carries conditioned power at primary voltage level.
- Distribution module, besides providing distribution, monitoring, and control functions, also performs voltage step-down and common mode noise isolation at point-of-use.

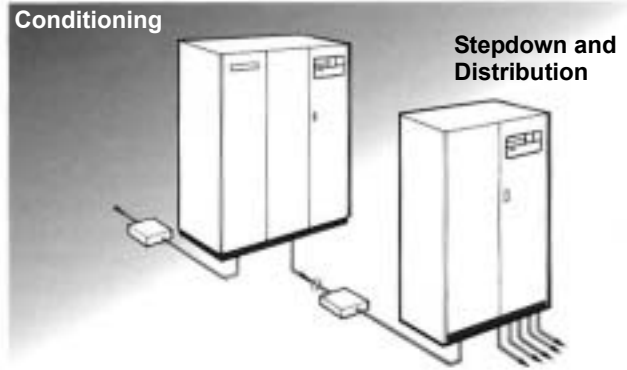

For Multiple Distribution

The Remote Distribution System or the Remote Step-Down System can be arranged so that the Model CA Datawave feeds two or more distribution modules. Multiple-distribution systems allow shorter distribution cable runs in a large computer room and separate computer facilities to be supplied from the same conditioning system, while retaining individual distribution, control, and monitoring.

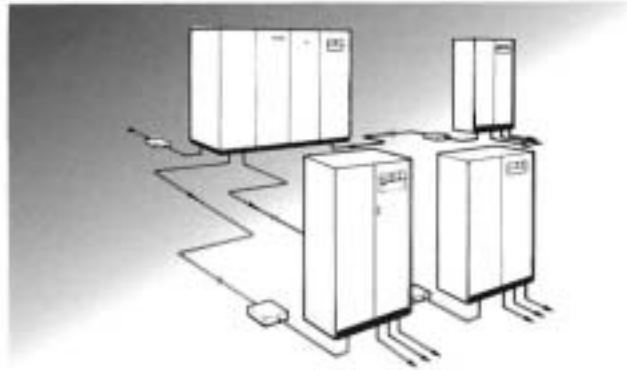

For Multiple-Utility-Feed Systems

Where the probability that both utility feeds would fail simultaneously is very remote, the power reliability obtained by feeding the Datawave installations from more than one utility feed can approach that obtained from a UPS system.

Multiple input systems use a static transfer switch to select the input feeder for connection to the power conditioning system.

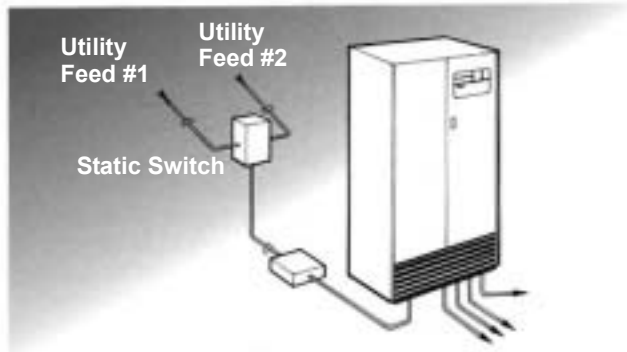

For General Distribution Systems

The Model SC Datawave can be used in new office buildings to supply “noise-free” power circuits generally distributed throughout the building for desktop computers and word processors. The unbalanced-load-handling capability of the Datawave magnetic synthesizer technology makes it ideal for conditioning such a distribution system, since the loads are predominantly single-phase, and cannot be closely controlled for balance. The Datawave system also provides step-down to eliminate the need for a step-down transformer.

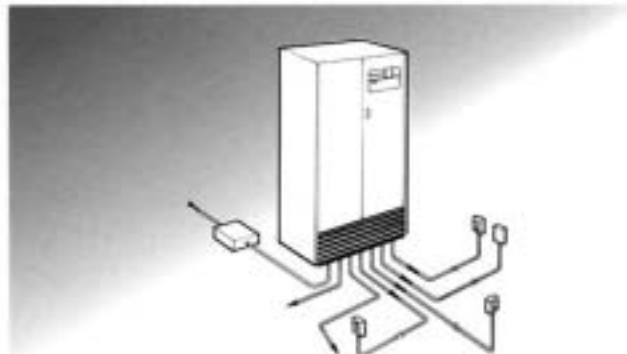

Paralleling Units

Parallel Datawave units are used for redundancy or to power loads greater than 200 kVA. Datawave magnetic synthesizers can be paralleled without special paralleling circuitry, with the resulting parallel system performing as a single magnetic synthesizer of the combined capacity.

Specifications such as voltage regulation, capacity, efficiency, and harmonic distortion are not affected by paralleling.

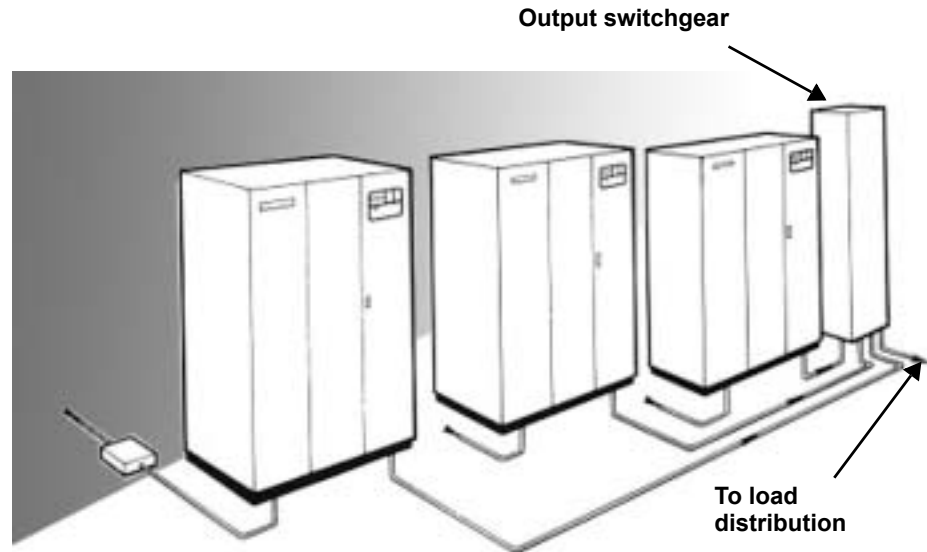

Beyond Power Conditioning: Harmonic Isolation

Today, as more and more users of electronic equipment become concerned about harmonics, the Datawave Magnetic Synthesizer is being increasingly applied as a harmonic isolator.

Because of its basic operation, the Datawave Magnetic Synthesizer isolates its output from its input. This capability allows the Datawave system to provide harmonic isolation as well as power conditioning. The output voltage is regenerated, free of any input voltage distortion, notching or transients.

Further, the Datawave system is designed to be compatible with nonlinear loads without derating, including single-phase, switched-mode power supplies.

The Datawave Magnetic Synthesizer isolates the power system from the harmonic current distortion caused by nonlinear loads. Its input current distortion remains less than 8% THD even with output load current distortions over 110% THD.

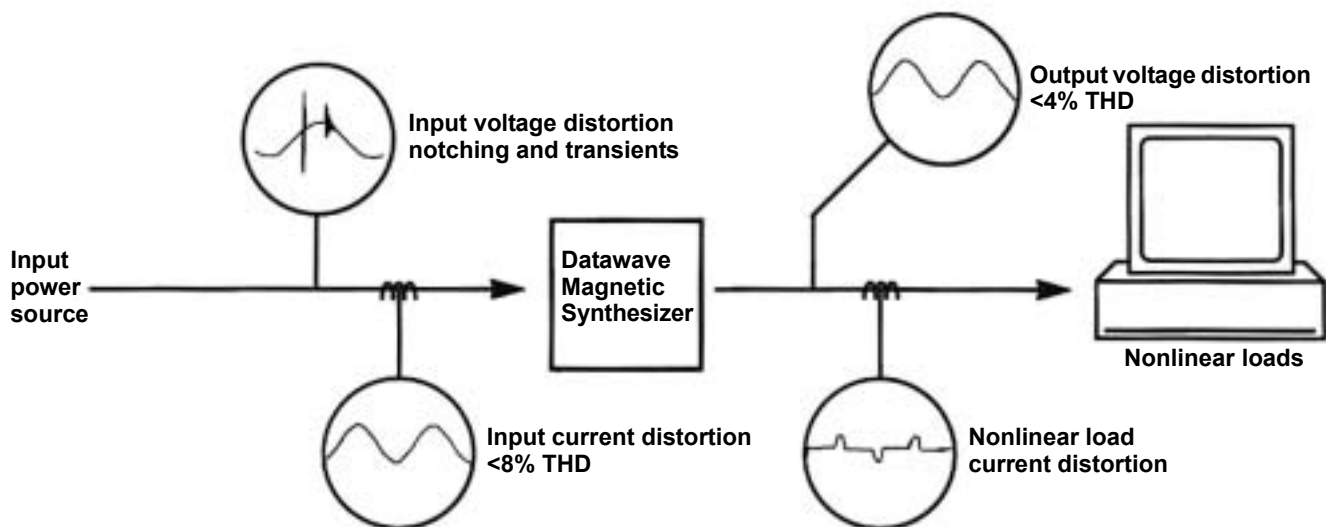

STANDARD FEATURES FOR ALL SYSTEMS

All Liebert Datawave systems incorporate a number of standard features to ensure load protection and to simplify maintenance.

The **Datawave magnetic synthesizer** uses heavy-duty dry type transformers and high reliability capacitors to regenerate clean output power. Power to the critical load is regulated to within $\pm 5\%$ for input power varying from +40% to -40% of nominal. (Refer to **Operational Description on page 4** and **Voltage Regulation on page 14**.)

Each magnetic component in the magnetic synthesizer is equipped with two **temperature sensors** in the windings. One sensor provides an alarm if any internal temperature exceeds 180°C, the other shuts down the system if any internal temperature exceeds 200°C, even though full class H 220°C transformer insulation is utilized.



Temperature sensors

A **main input circuit breaker** provides either manual control or automatic shutdown of the system in the event of an overcurrent condition. The breaker is molded-case, rated to provide coordination with output protection devices. In addition to manual and thermal-magnetic trip, the input breaker can be tripped by an electrically actuated **shunt trip** mechanism. As a standard feature, the shunt trip of the input circuit breaker is activated by the 200°C temperature sensors, local Emergency Power Off switch, and Manual Restart circuit.

The **local Emergency Power Off (EPO)** switch is an illuminated push button, easily accessible for emergency shutdown use, but fully guarded to prevent accidental operation.



Input circuit breaker

The **manual restart** circuit shunt-trips the main input breaker whenever input power is lost. This isolates the system from repetitive power applications during fault-clearing operations by the utility and allows an orderly restart of the system when normal power returns.

The manual restart circuit can be disabled by the **manual restart switch**. The auto position of the switch defeats manual restart, and allows the conditioner to automatically restart when power returns. Auto restart is useful for unattended remote sites where the load can automatically restart, and in those applications when the manual restart function is provided elsewhere in the system.

The low-voltage shunt trip circuit also allows system shutdown by external relays, Remote Emergency Power Off (REPO) switches, or other remote devices.

A double-pole, double-throw (dpdt) **building interface relay** is powered by a 24 volt DC supply from the output of the magnetic synthesizer. Energized whenever the Datawave system is on, the relay drops out if the output voltage disappears for any reason. The relay can be used for remote alarming of system shutdown, or shutdown interface with additional loads such as environmental control units.

Datawave system components are housed in a **welded steel frame** with removable cabinet panels to provide maximum accessibility to the interior. For safety and security, any panels which provide access to high voltage areas require a tool for removal.

Cabinet colors are available to match or accent the computer equipment or room decor.

OPTIONAL FEATURES FOR ALL SYSTEMS

Individually Protected Panelboards

One 42-pole panelboard is provided on 15-30 kVA Model SC units; two (for a total of 84 poles) are provided on 50-75 kVA SC units; and four 30 pole panelboards for a total of 120 poles are provided for 100-200 kVA SC units. Each panelboard is protected by a main circuit breaker to prevent overload and allow manual shutdown of the entire panelboard. Each panelboard is

enclosed for safety, and has individual isolated neutral and safety ground busbars.

Output circuits are protected by single-, two-, or three-pole thermal-magnetic molded-case branch circuit breakers sized specifically for the load to be served. (Standard panelboards use plug-in breakers.)

Optional Panelboard Types

Branch circuit panelboards which accept bolt-in type circuit

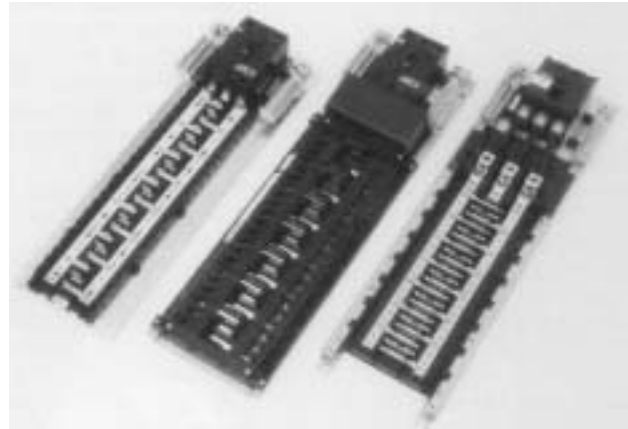

breakers are optional for the Datawave system, as are panelboards for

plug-in or bolt-in breakers manufactured by Square-D™ Corp.

Flexible Output Cables & Terminations



A flexible output cable system is available for SC units. Cable conductors are protected by a jacketed, liquid-tight, flexible steel conduit with a copper shielding conductor. Each output cable is fabricated to any specified length and type of termination to match the equipment to which it is to be connected

Add-on cables for field installation can also be fabricated. Terminations include:

- Receptacles to match equipment plugs.
- Conduit termination fittings with conductor "pigtailed" for hard wire connection.

Subfeed Output Circuit Breaker

A subfeed output circuit breaker, powered ahead of the output panelboards, is available on the Self-Contained Datawave units to feed a remote distribution unit, panelboards, or other loads.

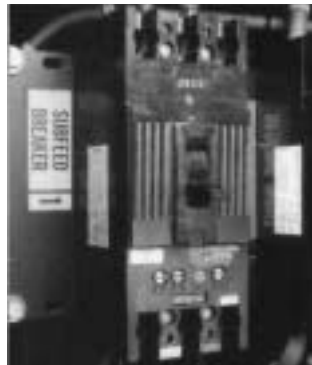

A single subfeed breaker (225-amp max) is available on Model SC 50 or 75 kVA systems. Either one (400-amp max) or two (225-amp each max) subfeed output breakers are available on Model SC 100-200 kVA systems.

Main Output Circuit Breaker

A molded case, thermal magnetic circuit breaker sized for 125% of the Datawave's output full load amps is provided on all standard CA units. The main output circuit breaker provides a main disconnect and overcurrent protection for the Datawave output power feeder.

High-Voltage Junction Box With Flexible Input Cable



The high-voltage junction box can be installed under a raised floor system. The junction box contains terminals for connecting the incoming power line and ground conductors. A 10ft (3m) flexible cable is furnished for connection between the junction box and the Datawave main input circuit breaker.

Low-Voltage Junction Box with Flexible Input Cable

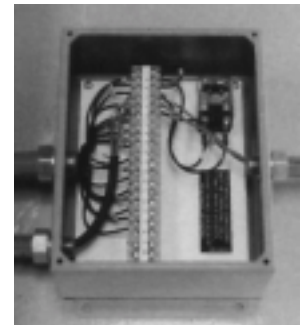

The low-voltage junction box can be installed under a raised floor. It contains terminals for connection of all building interface alarms or controls, and all Remote Emergency Power Off switches. A 10ft (3m) flexible control cable for the system is furnished for connection between the junction box and the Datawave system.

Reserve Input Junction Box with Flexible Input Cable

The reserve input high-voltage junction box can be installed under a raised floor system. The junction box contains terminals for connecting the reserve input power line, neutral, and ground conductors. A 10-foot (3-meter) flexible cable is furnished for connection between the junction box and the Datawave reserve input circuit breaker.

Remote Emergency Power Off (REPO) Switch



Pressing the REPO push button activates the shunt trip mechanism of the main input circuit breaker, shutting down the system.

The illuminated and fully guarded REPO button is mounted in a wall box.

The assembly includes 50 feet (15.2 meters) of 3-conductor cable for wiring to the building interface system. Additional lengths of cable are available.

Secondary Class Surge Arrester

A secondary class surge arrester is wired to all three phases of the input power to shunt otherwise damaging voltage surges to the building ground.



The arrester is rated for a maximum FOW spark-over of 3200 volts with maximum discharge voltage of 2.2 kV at 1500 amperes, assuming a standard 8 x 20 microsecond waveform.

The sure arrester provides protection for the Datawave against those very high voltage surges which can cause insulation or wiring failures.

Bypass Transformer

The bypass transformer is a 3-phase isolation transformer, furnished in a NEMA 1 (general purpose) enclosure. The bypass transformer is used with the bypass switch to provide step-down and/or isolation for the bypass leg of the Datawave system.

An optional decorative cabinet may be provided when desired. The cabinet color may be selected to match or accent the room decor.

Floor Pedestals



In rooms without a raised floor, the floor pedestals provide space for the bottom entrance of cables (and cooling air). The height of the floor pedestals is customer-specified.

Standard floor pedestal height range: adjustable from 8.6 to 13.3 in. (218 to 336 mm).

Other available ranges are: 6 to 8.5 in. (152 to 216 mm), and 13.5 to 18 in. (343 to 457 mm).

Bypass Switch



The bypass switch facilitates system maintenance by allowing the magnetic synthesizer of the Datawave system to be taken out of the circuit, or bypassed, with continued system operation.

Transient Suppression Plate

The transient suppression plate is a one square meter metal plate mounted to (and bonded to) the high-voltage junction box. It reduces the effects of transients on the ground system by providing a capacitive coupling to building steel.

Phase Rotation Meter

The phase rotation meter is a handheld instrument with clip-on leads for connecting to the circuit under test. Upon meter connection and circuit energization, the meter shows whether the circuit phase rotation is in "ABC" or "BAC" sequence.

The phase rotation meter can be used to verify the rotation sequence of any three-phase circuit up to 600 volts.

SITE MONITORING

Monitoring systems for Liebert power conditioners range from temperature sensing to multiple-parameter monitoring

with remote display and printout.

All units are equipped with a guarded and illuminated Local Emergency Power Off

switch; provisions for connecting Remote Emergency Power Off switch; selectable auto or manual restart feature, to allow an orderly

system restart after a power failure; a summary alarm contact; and a building interface relay.

Power Monitor Panel

True RMS techniques are used to provide accurate measurements of Datawave operation, while the high visibility Liquid Crystal Display provides clear reporting. The, microprocessor-based power monitoring system continuously monitors and sequentially displays the following parameters:

- Input voltages, line-to-line for each phase
- Output voltages, line-to-line and line-to-neutral for each phase
- Output currents for each phase, including neutral and ground currents
- Output voltage THD for each phase
- Output current THD for each phase
- K-factor and crest factor
- Output power including kVA, kW, kW-Hours, power factor, percent load and output frequency.



The monitor panel also provides warning of out-of-spec conditions through audible alarm and displayed alarm messages. All alarmed conditions are retained in a nonvolatile memory until reset. Alarm thresholds are adjustable to meet individual site needs.

Alarmed conditions include:

- Output overvoltage
- Output undervoltage
- Output voltage THD
- Output overcurrent
- Neutral overcurrent
- Ground overcurrent
- Transformer overtemperature
- Frequency deviation
- Phase sequence error
- Phase loss
- Five customer-specified alarm conditions.

For additional application flexibility, the following alarms can be configured to shut down the system:

- Output over-/undervoltage
- Phase sequence error/phase loss
- Ground overcurrent

Through a two-conductor communications cable, the system can communicate alarms and monitored conditions to a Liebert Site-Scan central monitoring system. An isolated RS-232 ASCII communication port is provided for communication to other monitoring systems.

Basic Temperature Monitoring Panel

The Transformer Overtemperature alarm indicator is a part of the 180°C transformer temperature sensing circuit. This configuration is optional on all units.

SiteScan

SiteScan is an online center for monitoring and controlling all support systems in a large data processing installation. SiteScan provides early warning alarms and total site management data. A software-based system using a microcomputer as the central processing center, SiteScan is programmable, menu-driven, and upgradeable. Four primary site management programs are built into SiteScan:

Alarm functions provide instant warning of potential problems. A seven level selection of options for response to each alarm offers total flexibility in designing a custom-tailored alarm system.

Control functions allow critical setpoints and sensitivities to be adjusted by remote control for dynamic, single-point site management. Password access preserves site security.

Status functions provide complete information on all computer support systems, including real-time status of all monitored parameters and any alarm conditions.

History functions offer database management capabilities. These functions track, store and graphically display crucial data and trends for site management activities such as capacity analysis, growth predictions, and energy management.



SiteScan makes full use of all features of its computer-based central processor, including RS-232 communications and other output ports and unlimited expansion via multiplexers.

For critical data processing facilities, the SiteScan system offers total site management capability in a virtually obsolescence-proof configuration.

AVAILABILITY

	Model SC			Model CA		
	15-30 kVA	50-75 kVA	100-200 kVA	15-30 kVA	50-75 kVA	100-200 kVA
Individually protected panelboards	Standard (panelboard) 42 poles	Standard (2 panelboards) 84 poles	Standard (4 panelboards) 120 poles	Not applicable	Not applicable	Not applicable
Flexible Output Cables and Terminations	Optional	Optional	Optional	Not applicable	Not applicable	Not applicable
Optional Panelboard Types	Optional	Optional	Optional	Not applicable	Not applicable	Not applicable
Subfeed Output Circuit Breaker	Not available	Optional	Optional	Not applicable	Not applicable	Not applicable
Main Output Circuit Breaker	Not available	Not available	Not available	Standard	Standard	Standard
High-Voltage Junction Box With Flexible Input Cable	Standard	Standard	Optional	Optional	Optional	Optional
Low-Voltage Junction Box With Flexible Input Cable	Optional	Optional	Optional	Optional	Optional	Optional
Reserve Input Junction Box With Flexible Input Cable	Not applicable	Not applicable	Optional with Bypass Switch	Not applicable	Not applicable	Optional with Bypass Switch
Secondary Class Surge Arrester	Optional	Optional	Optional	Optional	Optional	Optional
Remote Emergency Power Off (REPO) Switch	Optional	Optional	Optional	Optional	Optional	Optional
Floor Pedestals	Optional	Optional	Optional	Optional	Optional	Optional
Bypass Switch	Optional	Optional	Optional	Optional	Optional	Optional
Bypass Transformer	Optional	Optional	Optional	Optional	Optional	Optional
Transient Suppression Plate	Optional with high-voltage junction box	Optional with high-voltage junction box	Optional with high-voltage junction box	Optional with high-voltage junction box	Optional with high-voltage junction box	Optional with high-voltage junction box
Power Monitor Panel	Standard	Standard	Standard	Optional	Optional	Optional
SiteScan	Optional	Optional	Optional	Optional	Optional	Optional

SYSTEM SIZING

A fundamental concern is the size of the conditioning system required to meet present and future needs.

Present Requirements

Estimating the present system size can be done in a number of ways, depending on the source of information available. Typical sources include the computer site planning manuals, equipment nameplate data, and the existing electrical service data. Present kVA requirements can be estimated using any of the following:

1. Kilowatts (kW) and Power Factor (pf)

$$\text{kVA} = \frac{\text{kW}}{\text{pf}}$$

(If pf is not given, assume an average of 0.80.)

2. Ampere specifications for the electrical service feeding the data processing area.

$$\text{kVA} = \frac{V \times A \times \sqrt{3}}{1000}$$

(for 3-phase systems)

3. BTU/hr or kcal/hr specifications.

$$\text{kW} = \frac{(\text{BTU}) / (\text{hr})}{3413} \quad \text{kW} = \frac{(\text{kcal}) / (\text{hr})}{860}$$

$$\text{kVA} = \frac{\text{kW}}{\text{pf}}$$

(If pf is not given, assume an average of 0.80.)

4. Power profile of equipment. (When available, this is the most reliable base from which to estimate present kVA loading.)

For 3-phase equipment:

$$\text{kVA} = \frac{V \times A \times \sqrt{3}}{1000}$$

$$A = \frac{\text{kVA} \times 1000}{V \times \sqrt{3}}$$

For single-phase equipment:

$$\text{kVA} = \frac{V \times A}{1000}$$

$$A = \frac{\text{kVA} \times 1000}{V}$$

After the present kVA requirement has been determined the anticipated growth and the special characteristics of the load must be considered.

Growth Requirements

The Datawave should be sized anticipating growth to protect against short-term obsolescence. With the growth rates associated with data processing centers, their power requirements double in a relatively short time. Therefore it is not unreasonable to size the conditioner for twice (or 200% of) the present estimated kVA load. Even in a minimum growth environment, the conditioner should be sized for 125% of the estimated kVA load.

Special Load Characteristics

Whenever special load characteristics are encountered, factory application engineers should be consulted for recommended system sizing.

System Grounding Considerations

The grounding of any power conditioning system is critical to its performance. When grounding for system performance, however, the first rule must always be safety. What good is a system that performs, but is not safe? The National Electrical Code provides for a safe electrical system. The ground path required by the NEC for safety should be enhanced or improved for a system performance, never defeated or eliminated. For detailed system grounding considerations, refer to the installation manual.

PHYSICAL AND ELECTRICAL DATA

Operational Characteristics

Input Transients

No spikes, transients, or other disturbances are evident on any of the three output phases when high-energy, ringing transients (ANSI C62.41, Category B) are impressed on the input lines.

Electrical Noise Suppression

Type	Suppression
Normal mode	120 dB
Common mode	120 dB

Short-Circuit Capability

The sustained short-circuit current available from the Datawave magnetic synthesizer is up to +200% of full-load current (continuously, or until protection circuitry is activated).

Output Voltage Harmonic Distortion (No-load to Full-load)

Total Harmonic Distortion—less than 4%

NOTE: Incoming line distortion is not additive to output Total Harmonic Distortion.

Voltage Regulation

Type	Input voltage (% of Nominal)	Load	Output Voltage (% of Nominal)
Normal	Nominal	0% to 100%	Nominal to +3%
High line/Low line	+40% to -40%	0% to 100%	+5% to -5%
Unbalanced input voltage	Nominal (single-phase)	0% to 60%	+5.8% to -4%
Unbalanced load	Nominal	100% on two phases 0% on one phase	+5% to -2%
Overload	Nominal	200%	-6%

Efficiency (Nominal Input Voltage)

	15-20 kVA	30 kVA	50-200 kVA
Full-load	89%	91%	93%
Three-quarter load	87%	89%	91.5%
Half-load	83%	86%	89%

Input Power Factor

From half-load to full-load—0.96 lead to 0.96 lag.

NOTE: Input power factor does not depend on load.

Input Current Distortion

Total Harmonic Distortion—less than 8%

NOTE: Input current distortion is independent of load power factor current distortion.

Audible Noise

15-30 kVA	55 dBA
50-75 kVA	58 dBA
100-200 kVA	63 dBA

NOTE: Average sound level, measured at 5 feet (1.6 meters).

Electrical Characteristics

Table 1 Electrical Characteristics

Voltage	kVA	Main Input			Output & Reserve Input		
		FLA	OPD	Suggested Feeder Wire Size (AWG)	FLA	OPD	Suggested Feeder Wire Size (AWG)
208V	15	49	60	6	42	60	6
	20	65	80	4	56	70	4
	30	95	125	1	83	110	2
	50	155	200	000	139	175	00
	75	233	300	350 kcmil	208	300	350 kcmil
	100	311	400	000 (2*)	277	350	500 kcmil
	125	389	500	250 kcmil (2*)	347	450	0000 (2*)
	150	466	600	350 kcmil (2*)	416	600	350 kcmil (2*)
200	622	800	300 kcmil (3*)	555	700	500 kcmil (2*)	
240V	15	42	60	6			
	20	56	70	4			
	30	83	100	2			
	50	135	175	00			
	75	202	250	250 kcmil			
	100	269	350	500 kcmil			
	125	337	450	0000 (2*)			
	150	404	500	250 kcmil (2*)			
200	539	700	500 kcmil (2*)				
380V	15	27	40	8	23	30	10
	20	36	50	8	30	40	8
	30	52	70	4	46	60	6
	50	85	110	2	76	100	3
	75	127	175	00	114	150	0
	100	170	225	0000	152	200	000
	125	213	300	350 kcmil	190	250	250 kcmil
	150	255	350	500 kcmil	228	300	350 kcmil
200	340	450	0000 (2*)	304	400	000 (2*)	
400V	15	25	40	8	22	30	10
	20	34	50	8	29	40	8
	30	50	70	4	43	60	6
	50	81	110	2	72	90	3
	75	121	175	00	108	150	0
	100	162	200	000	144	200	000
	125	202	250	250 kcmil	180	225	0000
	150	243	300	350 kcmil	217	300	350 kcmil
200	323	400	000 (2*)	289	400	000 (2*)	
415V	15	24	30	10	21	30	10
	20	33	40	8	28	40	8
	30	48	60	6	42	60	6
	50	78	100	3	70	90	3
	75	117	150	0	104	150	0
	100	156	200	000	139	175	00
	125	195	250	250 kcmil	174	225	0000
	150	234	300	350 kcmil	209	300	350 kcmil
200	312	400	000 (2*)	278	350	500 kcmil	
480V	15	21	30	10	18	25	10
	20	28	40	8	24	30	10
	30	41	50	8	36	50	8
	50	67	90	3	60	80	4
	75	101	125	1	90	125	1
	100	135	175	00	120	150	0
	125	168	225	0000	150	200	000
	150	202	250	250 kcmil	180	225	0000
200	269	350	500 kcmil	241	300	350 kcmil	
600V	15	17	25	10	14	20	12
	20	22	30	10	19	25	10
	30	33	50	8	29	40	8
	50	54	70	4	48	60	6
	75	81	110	2	72	90	3
	100	108	150	0	96	125	1
	125	135	175	00	120	150	0
	150	162	225	0000	144	200	000
200	216	300	350 kcmil	192	250	250 kcmil	

* Number of parallel feeders

Voltage and Current Ratings

The Datawave magnetic synthesizer has nine kVA capacities, from 15 kVA through 200 kVA. A range of voltage capabilities is available for each size, in both 50 and 60 Hz. **Table 1** shows common voltages, Full Load Ampere (FLA) values, and circuit breaker (OPD) ratings.

(For voltage ratings not shown, consult Factory).

NOTES:

1. FLA = Full Load Amps of Datawave system.
OPD= Overcurrent Protection Device inside Datawave unit.
(2*) = Two parallel feeders per NEC 300-20 and 310-4.
Wire Sizes based on NEC 1996 Table 310-16, using 75°C copper conductor.
2. Input feeder wire size listed in Table is the minimum feeder size recommended. Larger wire size may be required because of voltage drop or supply OPD.
3. Output feeder and Reserve Input feeder size listed in Table is the minimum size recommended. Larger wire size may be required because of voltage drop or harmonic neutral current (Ref. NEC Table 310-16 Notes 8 and 10). For best performance, Synthesizer should be located as close to the load as practical.
4. Insulated ground conductors are recommended to be parity sized with power conductors for increased system performance. Ground conductor minimum size must be per NEC, Table 250-95. Input power feeder conduit may be used as safety ground (customer option). If conduit is used, adequate electrical continuity must be maintained at conduit connection to enclosures and throughout conduit run.
5. Reserve input is used in bypass mode of Datawave system (100-200 kVA). Reserve input voltage must be same as Datawave system output voltage.
6. The Main Output Breaker listed in the table is typical for Model CA units only.
7. Standard Breaker Interrupting Ratings as follows. Other ratings available upon request.

	OPD	208V	380-415V	480V	600V
Up to 250A	65KA	15KA	35KA	22KA	
300-600A	65KA	25KA	35KA	25KA	
700-800A	65KA	50KA	50KA	25KA	

Heat Output

The Datawave magnetic synthesizer is the most efficient of the power synthesizing technolo-

gies. As the Datawave operates, some energy is lost in the form of heat.

Table 2 shows the heat output of the Datawave system for each model at

one-half, three-quarter, and full loads (based on a unity load power factor).

Table 2 Heat output

Size	One-half load	Three-quarter load	Full load
kVA/kW	BTU/hr (kW)	BTU/hr (kW)	BTU/hr (kW)
15	5250 (1.54)	5750 (1.68)	6350 (1.85)
20	6990 (2.05)	7650 (2.24)	8450 (2.47)
30	8350 (2.44)	9490 (2.78)	10125 (2.97)
50	10550 (3.09)	11890 (3.48)	12850 (3.76)
75	15820 (4.63)	17830 (5.23)	19270 (5.65)
100	21090 (6.18)	23780 (6.97)	25700 (7.53)
125	26360 (7.72)	29720 (8.71)	32100 (9.41)
150	31640 (9.3)	35670 (10.5)	38500 (11.3)
200	42180 (12.4)	45760 (13.9)	51400 (15.1)

Environmental characteristics are:

- Temperature, operating 0°C to +40°C
- Temperature, storage -55°C to +85°C
- Relative humidity 0% to 95% (non-condensing)

Physical and Mechanical Characteristics

Weights and Dimensions

The weights and dimensions of the Datawave magnetic synthesizers are shown in **Table 3**.

(All weights and dimensions are those of an uncrated unit, less cables and floor pedestals.)

Table 3 Weight and dimensions

Size	60 Hz	50 Hz	W x D x H
kVA	lbs (kg)	lbs (kg)	Inches (mm)
15	1200 (545)	1300 (590)	36x34x64 (914x863x1626)
20	1500 (680)	1600 (730)	36x34x64 (914x863x1626)
30	1600 (730)	1700 (775)	36x34x64 (914x863x1626)
50	2400 (1090)	2640 (1200)	44x32x68 (1118x813x1727)
75	2750 (1250)	3025 (1375)	44x32x68 (1118x813x1727)
100	3900 (1775)	4400 (2000)	66x36x76 (1676x914x1931)
125	4300 (1955)	4900 (2230)	66x36x76 (1676x914x1931)
150 Module A	2650 (1205)	2990 (1360)	52x36x76 (1321x914x1931)
150 Module B	3150 (1430)	3500 (1590)	52x36x76 (1321x914x1931)
200 Module A	3000 (1365)	3410 (1550)	52x36x76 (1321x914x1931)
200 Module B	3500 (1590)	3940 (1790)	52x36x76 (1321x914x1931)

Floor Loading

Data for both distributed and concentrated floor loading of the Datawave magnetic synthesizer are shown in **Table 4**. Distributed floor loading values reflect the weight of the unit over its entire footprint area, and is expressed in lb/ft² or kg/m². Concentrated floor loading values reflect the weight of the unit at each point of support.

Table 4 Floor loading

Size	Distributed floor loading (Wt. per unit area)		Concentrated floor loading (Wt. at each support point)	
	60 Hz	50 Hz	60 Hz	50 Hz
kVA	lb/ft ² (kg/m ²)	lb/ft ² (kg/m ²)	lbs (kg)	lbs (kg)
15	141 (691)	153 (748)	300 (136)	325 (148)
20	176 (862)	188 (925)	375 (170)	400 (183)
30	188 (925)	200 (983)	400 (183)	425 (194)
50	245 (1199)	270 (1320)	600 (273)	660 (300)
75	281 (1375)	309 (1513)	688 (313)	756 (344)
100	236 (1159)	267 (1305)	975* (444)*	1100* (500)*
125	261 (1276)	297 (1456)	1075* (489)*	1225* (558)*
150 Module A	204 (998)	230 (1126)	663* (301)*	748* (340)*
150 Module B	242 (1184)	269 (1317)	788* (358)*	875* (398)*
200 Module A	231 (1131)	262 (1284)	750* (341)*	853* (388)*
200 Module B	269 (1317)	303 (1483)	875* (398)*	985* (448)*

* Floor stand or pedestal-equipped units only—otherwise there are no concentrated loading points for these units.

Service Access and Clearance Requirements

The Datawave magnetic synthesizer is designed to require minimal servicing. Access areas and recommended minimum clearances of each module are described below.

15-20-30 kVA Sizes

Recommended minimum service clearances should exist at the front and one other side or rear as shown.

Service clearance extends 42 inches (1067 mm) from the unit in accordance with the National Electrical Code.

Model SC units require at least 6 inches (143 mm) at the bottom of the unit for cable routing. If the unit is not installed on a raised floor, floor pedestals must be provided.

(Non-raised floor applications are not CSA-approved.)

There should be 18 inches (457 mm) above the unit for cooling air exhaust.

50-75 kVA Sizes

Recommended minimum service clearances for the 50 and 75 kVA sizes should exist at the front and left side. Where possible, service clearance is recommended at the front and rear. Service clearance extends 42 inches (1067 mm) from the unit in accordance with the National Electrical Code.

Model SC units require at least 6 inches (143 mm) clearance at the bottom of the unit for cable exit. (NOTE: If bottom cable exit or distribution cables are used, the unit must be installed on a raised floor, or floor pedestals must be provided.)

Non-raised floor applications are not CSA-approved.)

There should be 18 inches (457 mm) above the unit for cooling air flow.

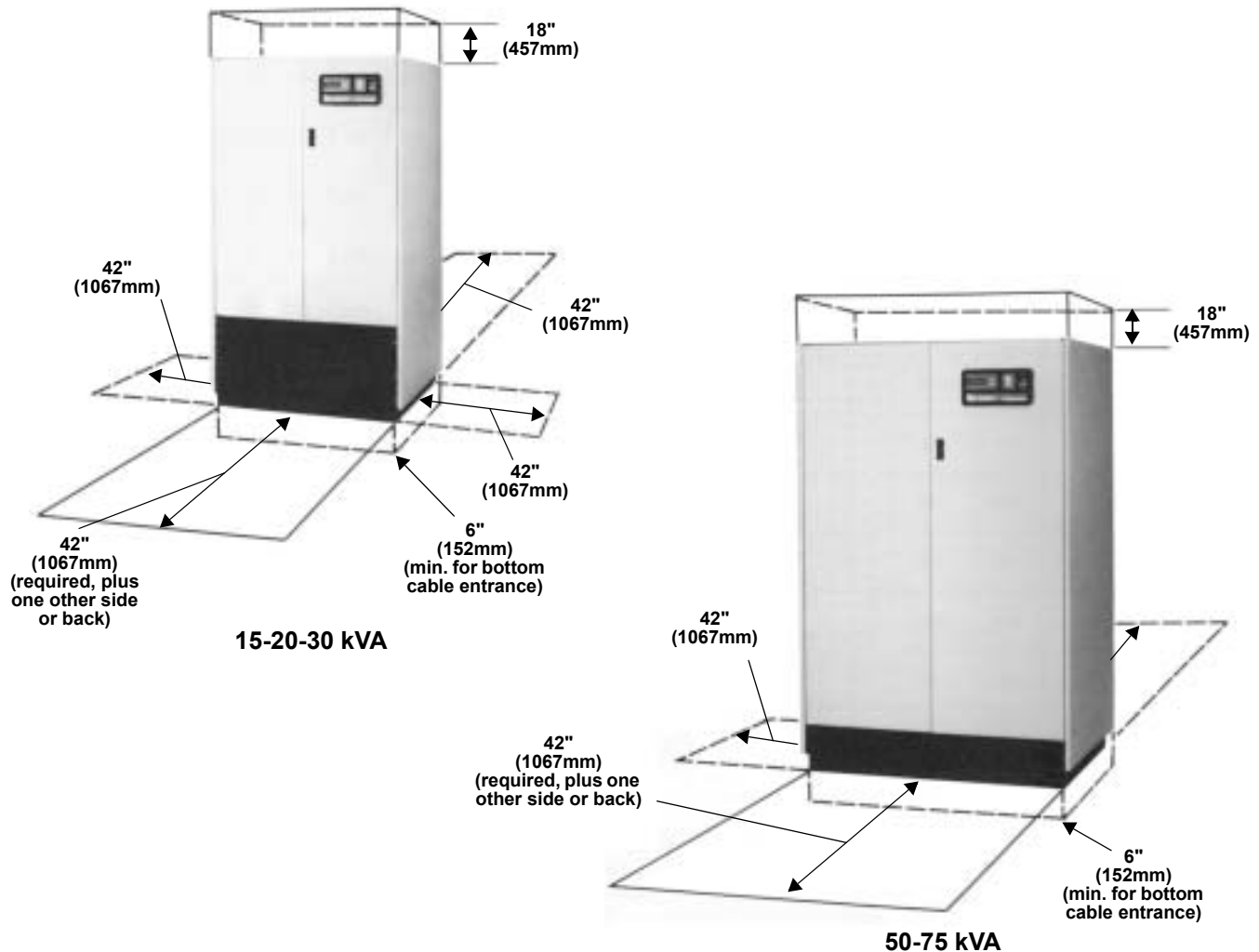

100-200 kVA Sizes

Recommended minimum service clearances for the 100 to 200 kVA sizes are as shown. Front service clearance is required. Model SC units require additional service clearance on the right side for access to the output distribution. Service clear-

ance extends 42 inches (1067 mm) from the unit in accordance with the National Electrical Code. There must be 6 inches (143 mm) clearance at the bottom of the unit if bottom cable exit is desired.

(NOTE: If bottom cable exit or distribution cables are used, the unit must be installed on a raised floor, or floor pedestals must be provided. **Non-raised floor applications are not CSA-approved.**)

There should be 18 inches (457 mm) above the unit for cooling air flow.

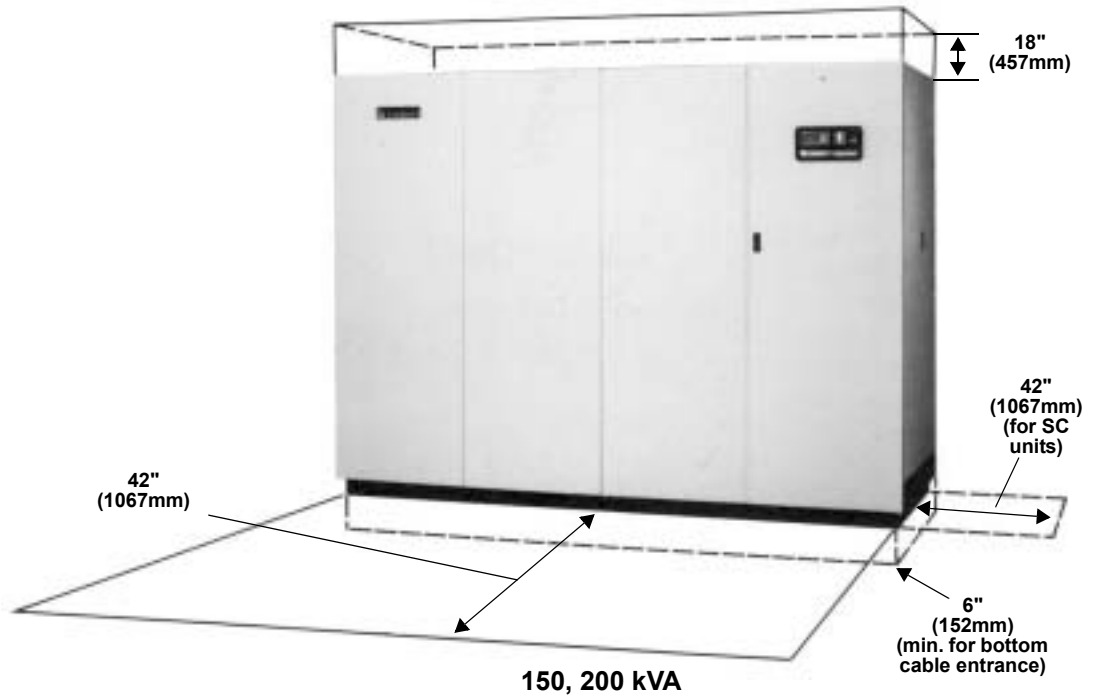
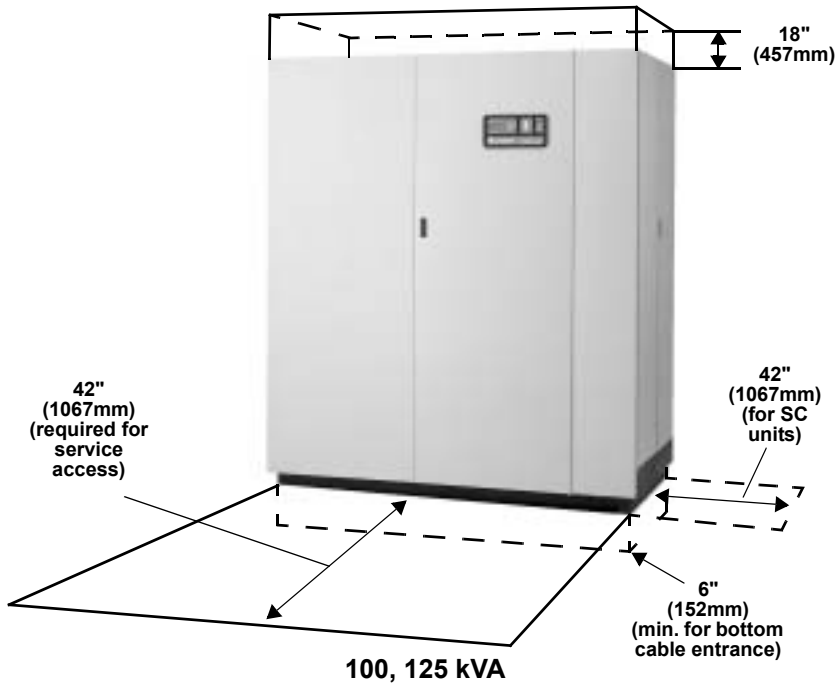

**DISCONTINUED
PRODUCT**

The Company Behind the Products

With over a million installations around the globe, Liebert is the world leader in computer protection systems. Since its founding in 1965, Liebert has developed a complete range of support and protection systems for sensitive electronics:

- Environmental systems—close-control air conditioning from 1 to 60 tons
- Power conditioning and UPS with power ranges from 300 VA to more than 1000 kVA
- Integrated systems that provide both environmental and power protection in a single, flexible package
- Monitoring and control—from systems of any size or location, on-site or remote
- Service and support through more than 100 service centers around the world and a 24/7 Customer Response Center

While every precaution has been taken to ensure the accuracy and completeness of this literature, Liebert Corporation assumes no responsibility and disclaims all liability for damages resulting from use of this information or for any errors or omissions.

© 2002 Liebert Corporation

All rights reserved throughout the world. Specifications subject to change without notice.

® Liebert and the Liebert logo are registered trademarks of Liebert Corporation. All names referred to are trademarks or registered trademarks of their respective owners.

SL-20184 (6/02)

Technical Support

United States

1050 Dearborn Drive
P.O. Box 29186
Columbus, OH 43229

Single-Phase UPS

800-222-5877

Outside the United States

614-841-6598

3-Phase UPS

800-543-2378

Environmental Control

800-543-2778

Italy

Via Leonardo Da Vinci 8
Zona Industriale Tognana
35028 Piove Di Sacco (PD)
+39 049 9719 111
FAX: +39 049 5841 257

Asia

23F, Allied Kajima Bldg.
138 Gloucester Road
Wanchai
Hong Kong
+852 2 572 2201
FAX: +852 2 831 0114

Web Site

www.liebert.com