



Vertiv™ Trinergy™ UPS



About Vertiv

Vertiv (NYSE: VRT) brings together hardware, software, analytics and ongoing services to enable its customers' vital applications to run continuously, perform optimally and grow with their business needs. Vertiv solves the most important challenges facing today's data centers, communication networks and commercial and industrial facilities with a portfolio of power, cooling and IT infrastructure solutions and services that extends from the cloud to the edge of the network. Headquartered in Westerville, Ohio, USA, Vertiv does business in more than 130 countries. For more information, and for the latest news and content from Vertiv, visit Vertiv.com.

Global presence, local expertise



Worldwide

Manuf. and Assembly Locations: **22**
 Service Centers: **240+**
 Service Field Engineers: **3,500+**
 Technical Support/Response: **190+**
 Customer Experience Centers/Labs: **19**

Americas

Manuf. and Assembly Locations: **8**
 Service Centers: **100+**
 Service Field Engineers: **1,600+**
 Technical Support/Response: **70+**
 Customer Experience Centers/Labs: **5**

Europe, Middle East, and Africa

Manuf. and Assembly Locations: **9**
 Service Centers: **60+**
 Service Field Engineers: **600+**
 Technical Support/Response: **100+**
 Customer Experience Centers/Labs: **5**











Asia Pacific

Manuf. and Assembly Locations: **5**
 Service Centers: **80+**
 Service Field Engineers: **1,300+**
 Technical Support/Response: **20+**
 Customer Experience Centers/Labs: **9**

Vertiv™ Trinergy™ Overview and Benefits At a Glance

Elevating performance, modularity, resilience, reliability and efficiency for your power needs. Vertiv™ Trinergy™ is the next-gen system built on a history of exceeding Tier IV data center power chain availability and over 40 years of technical innovation and global field-proven experience.



- 
Vertiv's most reliable, resilient and efficient UPS in its product class for unparalleled reliability and resilience
- 
Best-in-class modular system for maximum flexibility from room to pre-fabricated deployment
- 
Rich digital experience, Service empowered by data across entire lifecycle with Vertiv™ Life™ Advanced Incident Management and Condition Based Maintenance
- 
More power in a single block, compared to existing products, to support high density applications, **as AI or HP. Up to 40% space savings**, compared to our offering
- 
A Power Center ready to integrate different energy and back up power sources, including lithium-ion and nickel-zinc
- 
Hot and easy serviceability for no interruption, even during maintenance or power upgrades
- 
The ultimate optimized high-power solution for global standards and easy installation
- 
 Designed, manufactured, tested and available **across the globe**
- 
AI ready to support fast dynamic power loads
- 
Skid-mount and containerized power solutions for an easy deployment

	Tier IV data center power-system	Vertiv™ Trinergy™
Availability	99.9994% Source: Uptime Institute	99.9999998% Source: <ul style="list-style-type: none"> • Real measured UPS data • 40 years of experience • 15,000 monitored UPS
Downtime	8 hours in 10 years	30 seconds in 10 years

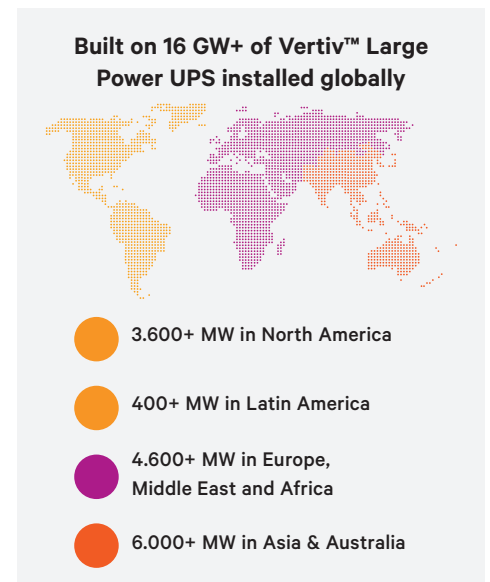

Over four decades, advancements have improved reliability and reduced repair times. These gains stem from a strong foundation of innovation and expertise. Vertiv™ Trinergy™ builds on these achievements.

Discover **Vertiv™ Trinergy™** and request a demo



Watch the "**Resilience built to last**" video

Vertiv's most reliable, resilient and efficient UPS in its product class

Datacenters face mounting pressures to ensure unflinching uptime and reliability. Responding to these exigencies, Vertiv™ Trineergy™ UPS is intricately designed to meet and surpass the contemporary resilience benchmarks. This is not just a response to market trends and needs but is deeply rooted in the lessons learnt and end user necessities, reflecting a commitment to address and integrate user feedback into tangible enhancements.

Design Reliability

At the core of the Vertiv Trineergy reliability is the application of Design Failure Mode and Effect Analysis (FMEA), a proactive methodology that meticulously identifies potential points of failure and mitigates them through strategic design enhancements.

This approach enables the development of certain product features that enhance the operational integrity and also offer substantial benefits to customers.

- **Distributed Batteries:** this battery architecture enhances the fault tolerance and system availability by improving the performance under several failure modes. The benefits of this architecture are supported by a whitepaper accessible via the QR code below. Centralised battery configuration is available.
- **Dedicated Segregated Controls for Each Core:** This design choice enhances the system's overall reliability, allowing each core to operate independently with its control logic.
- **Self-Isolating Cores Through Contactors:** In the event of a fault, affected cores can isolate themselves to prevent the spread of issues, ensuring the continuity of power supply from the remaining operational cores.
- **Continuous-Duty Booster:** Improved the robustness of the booster for continuous backup power, redefining also UPS capabilities to support the grid.
- **Continuous-Duty Solid State Static Bypass Switch:** For the maximum performances on the bypass line.
- **Hot Service and Hot Swap:** Facilitates maintenance and upgrades without necessitating system downtime, directly contributing to enhanced operational availability and reducing the risk of unplanned outages.
- **Enhanced Diagnostic Tools (Waveform Capture, Parametric Data, History Log):** Enable preemptive identification and resolution of potential issues before they impact system performance, offering a deep insight into system health and preempting failures.

Each of these features is designed to satisfy the needs of customers for resilience and availability.

Verification & Validation Tests

For the verification and validation of Vertiv™ Trineergy™ 30 MW of prototypes have been built.

This approach enables the development of certain product features that enhance the operational integrity and also offer substantial benefits to customers.

Verification and Validation Tests are critical in ensuring that UPS systems adhere to stringent performance standards. Engineering Validation Tests (EVT) and Design Validation Tests (DVT) rigorously assessed and confirmed the product specifications.

Through this process, Vertiv Trineergy has been validated against a spectrum of operational conditions to establish its capability to perform reliably in real-world scenarios. Additional tests have been performed to simulate critical conditions that a Vertiv Trineergy might encounter. Some of the additional tests performed are:

- **Structural Tests** to verify seismic resilience and general durability
- **Debris Protection Testing** for environmental robustness
- **Voltage Surge & Sag Tests** to ascertain electrical resilience
- **Highly Accelerated Life Testing (HALT)** provides accelerated aging scenarios to foresee long-term reliability

Download the White Paper “Enhancing UPS Reliability



with the Advantages of Distributed Battery Systems”

Modular Design to Meet the Needs of Each Application

Vertiv™ Trinerigy™ scales the concept of modularity up to all levels of the UPS architecture. Building blocks can be combined to fit different deployment types.

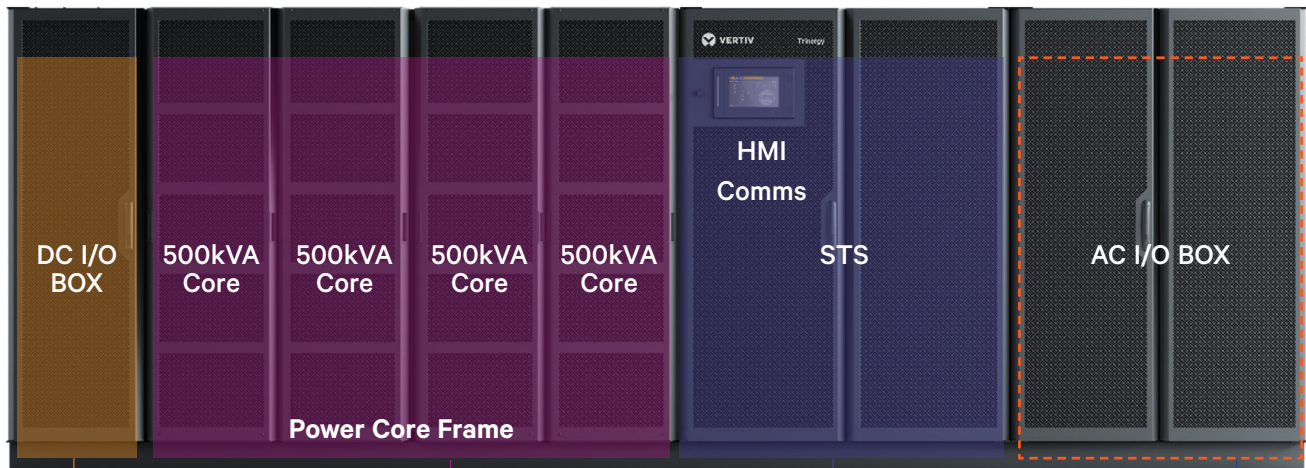

Dedicated DC I/O Cabinet

The DC power connections are routed through a dedicated cabinet, featuring top and bottom power connections and an integrated DC ground fault detection option.

500kW UPS Cores

Each core is independent and includes the components of an online UPS: inverter, rectifier and booster/charger.

It features one global design with options for 400V and 480V, compliant with both CE and UL standards.

Static Switch Cabinet

The bypass static switch is housed in a dedicated cabinet, offering an integrated backfeed disconnect option, power terminals for close-coupled applications, and support for single or dual input configurations. It follows a global design for 400V and 480V.

AC I/O Cabinet

AC I/O Cabinet

AC power connections are routed through a dedicated cabinet:

- **Top** and **bottom** power connection
- **Cable** or **flange** connection
- This cabinet can be **adapted or removed** for **close-coupled applications**

The **Vertiv™ Trinerigy™ Bypass Static Switch** redefines power distribution in compact environments. Featuring power terminals, it **minimizes footprint and maximizes power density**, ideal for skid, container, and close-coupled applications. With no need for an AC I/O box, the switchgear connects directly to the STS cabinet terminals, simplifying installation. Moreover, in **skid/container** setups, a dedicated junction cabinet replaces the AC I/O box, streamlining power connections. Vertiv Trinerigy seamlessly integrates with **Vertiv™ PowerNexus** and power skid solutions, offering modular design for maximum power density in any deployment scenario.



Capacity & Installation Flexibility from 1.5MW up to 20MW

Vertiv™ Trinergy™ features a **transformer-free design with full IGBT three-level double conversion technology**, providing extraordinary savings on installation and running costs, while at the same time delivering first class load protection and allowing rectifier allowing for electrical infrastructure cost saving, reducing the size of gensets, circuit protection, cabling and transformers.

Flexibility and Compatibility

Vertiv Trinergy can be fully adapted to meet diverse system requirements in terms of power capacity and redundancy allowing for different system designs, thus ensuring maximum flexibility:

- Output Power Factor up to 1
- No power derating from 0.4 lagging to 0.7 leading
- Optimum space/power ratio

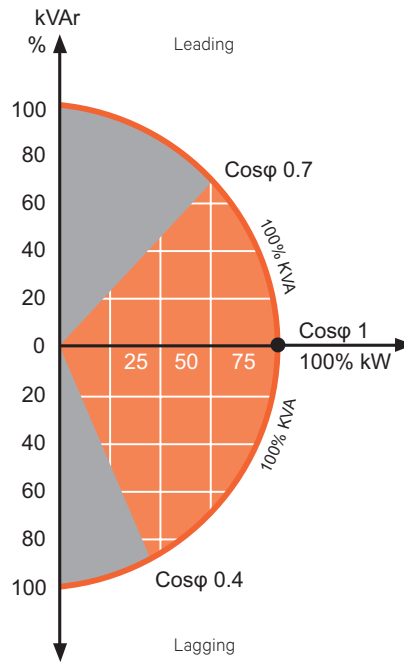

Figure 8: Power Factor Output Diagram

Maximized active power, high efficiency and complete compatibility for modern, mission critical IT loads.

Features and Performance

- Transformer-free design
- Full IGBT three-level NPC2 topology
- Excellent input performances:
 - PF > 0.99
 - THDi < 3%
- Automatic output power upgrade of up to +10%
- Three and four wire electrical compatibility
- Centralized and distributed parallel capabilities
- Seismic compliance

Customer Monitoring Interfaces

LCD Touch Screen Features

- High security access with separate password levels for users and service engineers
- User-friendly graphical interface
- Single-line mimic diagram showing system status
- Dedicated warning/fault and event log page used to monitor UPS status and important events
- Dedicated measurements page for all UPS internal functional blocks

Hardware Connectivity

Vertiv™ Trinergy™ allows for the monitoring and control of networked UPS, through different protocol options:

- The integration of UPS with Building Monitoring and Automation Systems via MODBUS RTU, MODBUS/TCP or JBUS protocols
- The integration of UPS in Network Management Systems through SNMP protocol
- Two slots for additional connectivity cards are available for specific protocol requirements

Software Connectivity

Vertiv connects and protects your network with core-to-edge solutions and unmatched expertise. For maximum visibility and effective monitoring in one view, pair your Vertiv™ UPS with a software solution.

Vertiv™ Environet™ Alert

Vertiv Environet Alert provides industry companies with critical facility monitoring software that is affordable and easy to use. This solution delivers superior monitoring, alerting, trending and data organization. Get monitoring, alerting and trending at a price that's right for your business.



Improved Efficiency

Vertiv™ Trinerger™ delivers an outstanding **double conversion efficiency of up to 97.1%**, which further increases **up to 99% with the dynamic online mode**, consequently reducing operating costs and energy dissipation (kW) to a minimum. This significantly minimizes the consumption of the cooling system, providing an overall TCO reduction and rapid payback time. Furthermore, through its intelligent **ECO mode** efficiency and the intelligent paralleling feature Vertiv Trinerger can optimize efficiency even at partial load achieving additional superior cost savings.

Vertiv Trinerger levels of efficiency and consequent electricity cost savings can be attributed to:

- Latest generation IGBT
- Adoption of a three-level NPC2 topology for both rectifier and inverter
- DC controlled fan speed
- Intelligent paralleling mode
- Advanced digital technology and fast transfer

The seamless activation of Vertiv Trinerger's functioning modes ensures the highest level

of efficiency without compromising power quality and availability.

The dynamic online mode ensures Class 1 output performance under most stringent conditions such as network faults (voltage variation, high/low impedance mains failures).

The unit is able to discriminate between various types of interferences and rapidly respond, while at the same time ensuring compatibility with downstream equipment such as servers, transformers, STS or mechanical loads.

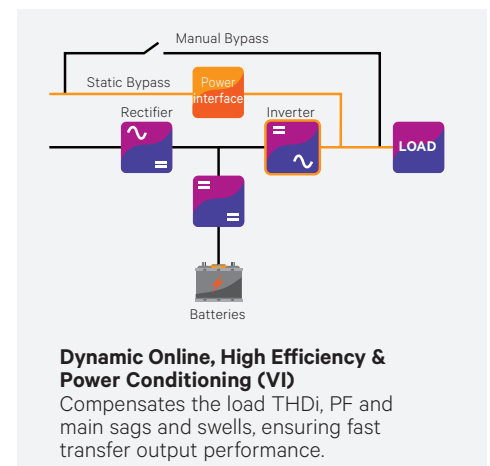
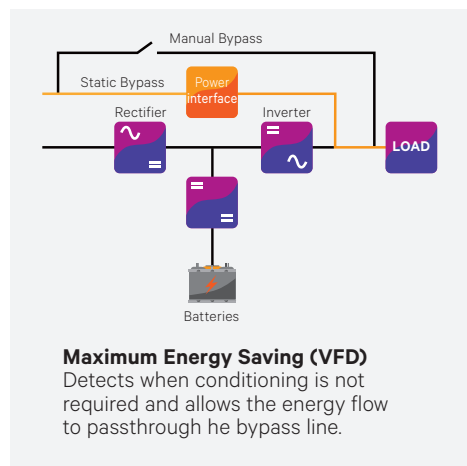
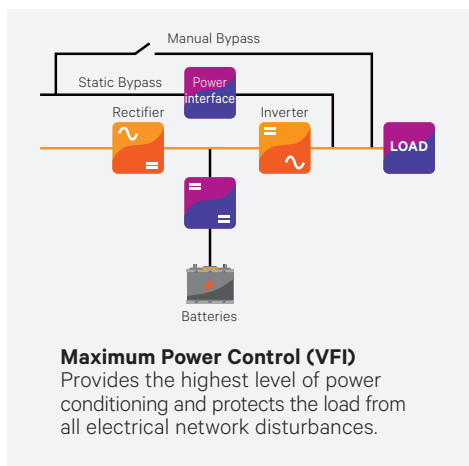

Dynamic Online mode: No more availability tradeoff with efficiency

Dynamic Online mode is developed for those that do not want to trade off any level of availability for incremental gains in efficiency. Dynamic Online mode enables **operating efficiency up to 99% without sacrificing availability**. While in this mode, the inverter can instantaneously assume the load and maintain the output voltage within the IEC 62040 Class 1 specification in most operating conditions, offering the same level of availability typically achieved in a double conversion operating mode.

Dynamic Online mode is therefore able to combine the **superior availability of a double conversion operating mode with the excellent energy cost savings of a high efficiency mode for a reduced total cost of ownership**.

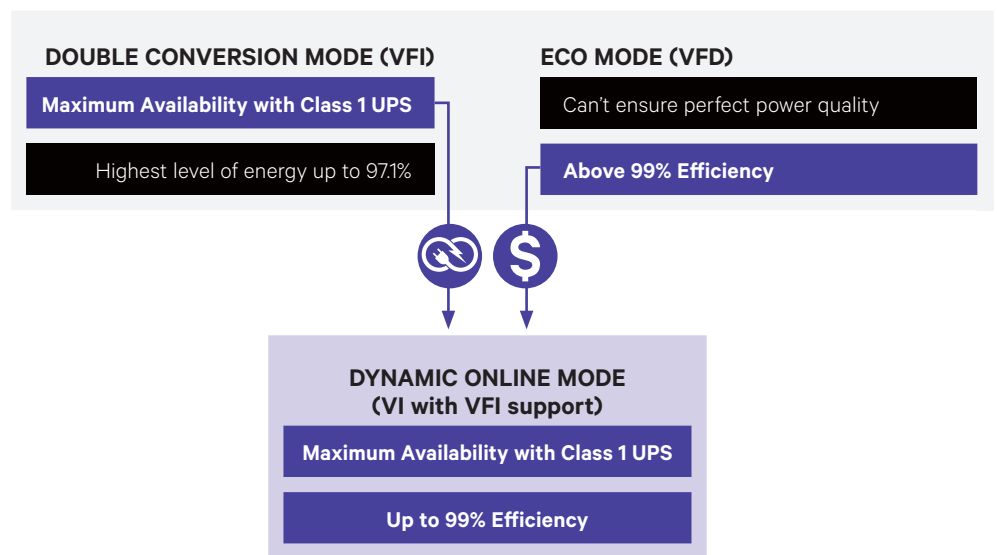

Learn more about the Dynamic Online mode in our White Paper **"High efficiency modes of operation"**



Continuous-duty booster and continuous-duty static bypass switch

Vertiv™ Trinergy™ Power Center stands out in the market for its **innovative continuous-duty booster converter**, a feature that ensures uninterrupted power supply even at full load indefinitely. This capability, made possible by advanced hardware design and control techniques, sets Trinergy apart from traditional UPS systems. Its ability to directly connect to DC sources enables **seamless integration with alternative power solutions like fuel cells, enhancing reliability and flexibility.**

Complementing its booster converter is Trinergy's solid-state static bypass switch, guaranteeing seamless power transitions. Trinergy's continuous-duty performance opens doors to various applications beyond traditional UPS systems. Some of its applications include:

- Long Duration Batteries integration
- Extended Dynamic Grid Support & Peak Shaving
- Integration with Renewables
- Integration with Micro Grid
- Fuel Cells integration for backup or prime power
- Integration with Distributed & Alternative Energy Sources

Trinergy is also well-suited for microgrid applications, offering reliable backup power in remote areas.

Moreover, its compatibility with fuel cells and other alternative energy sources provides clean and efficient backup power options. Vertiv Trinergy is a groundbreaking advancement in UPS technology, redefining reliability, flexibility, and sustainability in critical power infrastructure. With its innovative features and versatile design, Trinergy is poised to **shape the future of continuous backup power solutions.**

Power Source sharing is key to move toward a Power Center concept

PowerSource Sharing contributing to AI loads management, decarbonization and transition to green energy.

The continuous duty booster allows using indefinite DC source energy power, even at full load, between 400 up to 700Vdc, for **unlimited time adding an ultra high flexibility** in designing the new Data Centers solutions.

The power converters (AC/DC, DC/DC) can work simultaneously allowing the UPS to perform **source sharing**, enabling **extended backup power** solutions and supporting AI loads for **spikey loads** management.

Reduced TCO

Neutral Carbon Footprint

Vertiv Trinergy's new generation architecture has been designed to reduce energy and heat dissipation, consequently minimizing the demand and consumption of air conditioning systems.

The combination of these factors, coupled with a double conversion efficiency of up to 97%, reduces CO₂ emissions to a minimum. This contributes to ensuring that your customers' data centers are a step closer to meeting the industry's environmental and efficiency compliance standards.

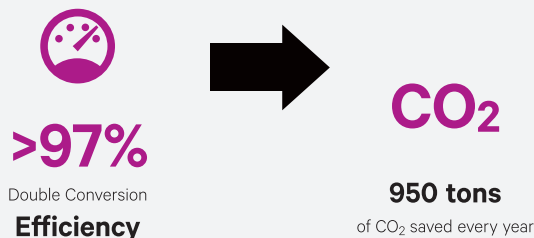

Advanced control diagnostic, excellent operating efficiency, intelligent paralleling feature, minimum footprint and high energy density make Vertiv Trinergy the perfect UPS to deliver secure power to all mission critical applications, maximum energy saving and rapid return on investment.

Vertiv Trinergy provides system capacity up to 20 MW which can be adapted according to diverse design requirements in terms of flexibility, redundancy and system reliability.

Furthermore, its **high power density** in a minimum space allows customers to maximize the number of racks and servers housed in their data center, thus granting more space for IT equipment.

The Vertiv Trinergy technology, has brought extraordinary benefits in terms of:

- Zero impact on upstream infrastructure
- Perfect compatibility with modern mission critical loads
- Enhanced performances for maximum energy saving
- CO₂ emission reduction
- Maximum system flexibility for all installations
- Reduced TCO

Vertiv™ Trinergy™ Power Center Dynamic Grid Support Feature

Intermittent renewables continue to challenge conventional energy generation. Evening out this renewable supply requires new energy storage services behind the meter. Operators of data centers and other types of critical infrastructure have a key role to play in this shifting energy landscape which presents new ways to generate revenue and lower costs.

Vertiv™ Trinergy™ can provide frequency regulation by controlling the input power to support services such as frequency regulation-up, regulation-down, or both via charging and discharging of the battery.

Dedicated controls always maintain the necessary battery energy to support the critical load in event of an outage.

By enabling UPS grid services with elevated speed of response to frequency variations and other external commands, Vertiv allows data center owners to participate in specific demand and response programs (e.g. Fast Frequency Response and Peak Shaving).

Offering your site's energy demand flexibility will enable access to new revenue streams and cost saving opportunities. With a focus on your site's primary function these benefits can be realized with Vertiv Trinergy without operational impacts.

Dynamic Grid Support is available for a number of markets, including:

- Data Center
- Commercial
- Industrial
- Telecommunications

Application Example

A **1 MW** Data Center can enable revenue generation up to **100.000 €** each year

Grid Operating Modes Dynamic Grid Support

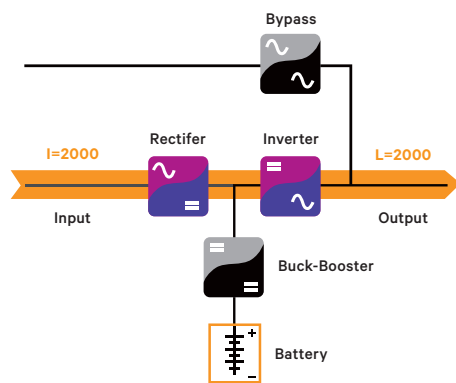

Standard UPS operation (normal operation)

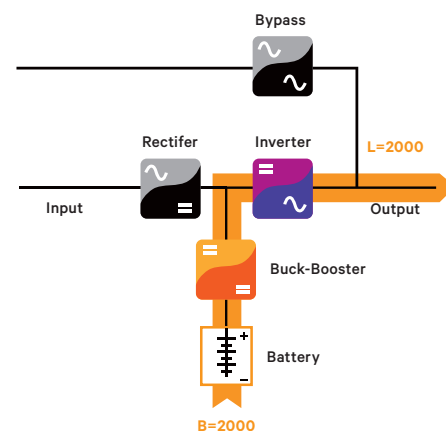

Discharge mode (full disconnection)

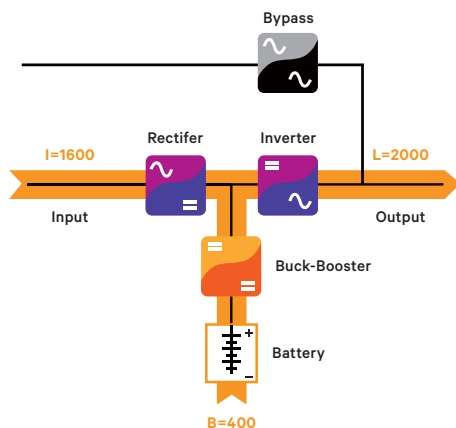

Discharge mode (Partial disconnection)

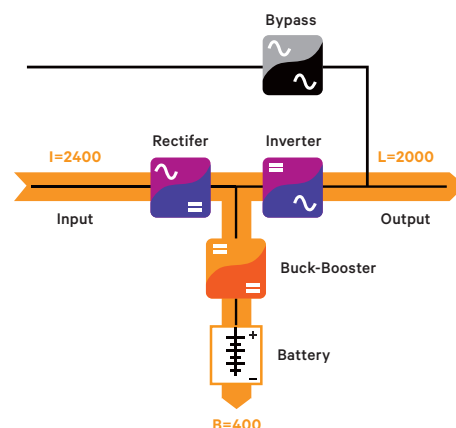

Recharge mode

User Interface and Advanced Diagnostic

Vertiv™ Trinergy™ makes your mission critical space a peaceful place through its advanced diagnostic capability, measuring and logging, enhanced event analysis as well as an intelligent colored multi-language touch screen display.

Vertiv Trinergy advanced DSP control platform together with the patented Vector Control technology enables increased performance of three-level power converters and real time control of output power quality, guaranteeing continuous operation and premium protection for your customer's business.

Bypass Input

Voltage and frequency measurements.

Mains Input

Current, voltage and frequency values of the three input phases.

Warning/fault

Alerts of anomalies on bypass, rectifier, inverter, booster/charger, battery and load.

Events log

Date and time of important UPS events, alarms and other warnings.

Measurements

Voltage, current and frequency values of each internal functional block.

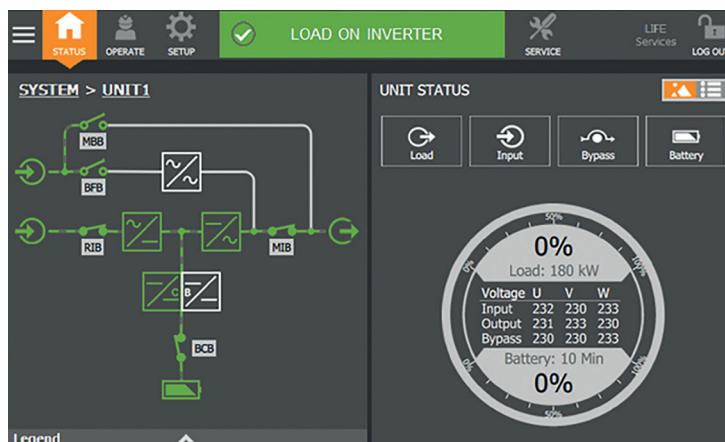

Waveform Capture: Enhancing Power Quality Analysis and System Reliability

Waveform Capture is a diagnostic tool that records the electrical waveforms of voltage and current. This capability is needed to understand and analyze power quality issues at critical moments (such as during power disturbances or faults) and to maintain the reliability of the power supply system.

The main advantages of Waveform Capture in Vertiv Trinergy are:

- **Precise Event Analysis:** By capturing the waveforms of both voltage and current during irregularities, the exact nature and cause of the disturbance can be understood. This includes recording events during and after an anomaly occurs.
- **Preventive Maintenance:** Regular monitoring of the waveform data can help in predicting potential UPS problems before they lead to system failures, thereby supporting preventive maintenance efforts.
- **Troubleshooting Support:** In the event of a failure, the stored waveform data provides valuable insight that can be used to troubleshoot issues, reducing the time required to restore normal operations.
- **Historical Data Logging:** Capturing and storing waveform data over time allows for the analysis of trends and the detection of gradual changes in the power system that may indicate emerging problems.
- **Customizable Data Capture:** Users can tailor the feature to their needs by selecting specific time frames and choosing the channels relevant to their power monitoring requirements. This ensures that only pertinent data is captured and reviewed.

The Waveform Capture feature in the Vertiv Trinergy UPS enhances uptime and reliability through detailed electrical waveform analysis, offering a robust tool for maintaining critical infrastructure.

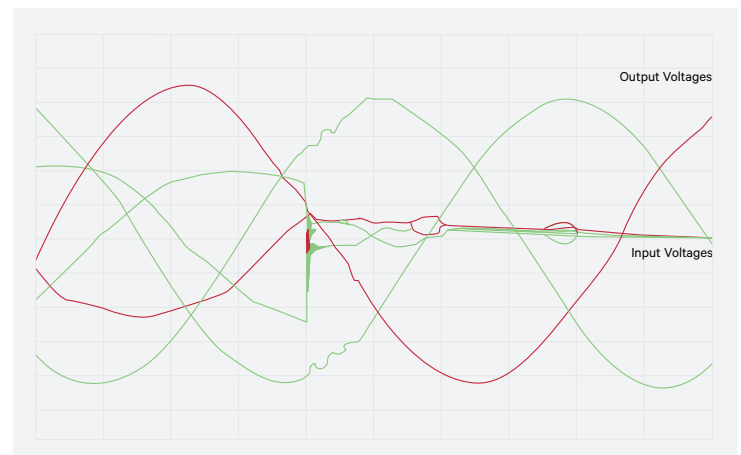

Rely on Integrated Project and Lifecycle UPS Services for Superior Critical Infrastructure Protection

Guarantee continuity to your business activities with a service partner who stands by you throughout your critical equipment lifecycle. From the project phase with start-up and testing, to lifecycle maintenance contracts and operational support, Vertiv ensures your solution performs optimally.

Global Presence & Local Resources



With the broadest, most comprehensive service presence in the industry and more than **3,500** engineers dedicated to servicing the entire world, Vertiv ensures that your business is always protected, and that service is available whenever needed 24 hours a day.

Project Services



From project planning and design, through to equipment procurement, installation, and commissioning, our project team offers comprehensive capabilities, ensuring speed of deployment and execution according to pre-defined and repeatable procedures.

Commissioning Phase	Technical Activities	Project Management
Pre-Project activity		<ul style="list-style-type: none"> Project Charter / Project Initiation Docs Identify Stakeholder
Level 0 Program and Design	<ul style="list-style-type: none"> Commissioning Spec & Plan Engineering Design Review Schedule Integration Submittal Review Commissioning Procedure Commissioning Kick-off 	<ul style="list-style-type: none"> Work Breakdown Structure (WBS) Supply Chain & Procurement Management Plan Project Team Creation Create Risk Management Plan Create Communication Management Plan Create Change Management Plan Create Project Schedule Health & Safety Assessment Kick-Off meeting with Customer
Level 1 Factory Witness Test	<ul style="list-style-type: none"> Factory Witness Test 	
Level 2 Delivery, QA/QC, Installation Assembly, Field Supervision	<ul style="list-style-type: none"> Site Acceptance Inspection Delivery & Assembly Equipment Installation 	<ul style="list-style-type: none"> Supply Chain & Procurement Management Execute Project Plan Schedule On-Site Resource Management Facilitate Team Meetings & Distributes Minutes Health & Safety Management
Level 3 Start-Up and Site Acceptance Test	<ul style="list-style-type: none"> Installation & Startup Pre-Functional Equipment Verification Site Acceptance Test 	
Level 4 Functional Performance Testing	<ul style="list-style-type: none"> Functional Performance Test 	
Level 5 Integrated System Test Support	<ul style="list-style-type: none"> Integrated System Test Training & O&M Verification 	
Level 6 Close Out & Turn-over	<ul style="list-style-type: none"> System Manual Seasonal Testing Warranty Review & Supplemental Report Commissioning Report 	<ul style="list-style-type: none"> Customer Acceptance Handover to Operation & Maintenance Lessons Learned Financial Closure Project Closure

- Manage Issues, Changes & Risks
- Report Project Status
- Contract, Financial & Quality Review
- Health & Safety Review

Expertise & Training



All service engineers are regularly certified according to country-specific regulations as well as wider international regulations and standards.

Vertiv service engineers are trained, experienced professionals who undergo an average of one week of intensive training each quarter, totalling one month of full-time training per year. Training includes both technology and safety, to ensure competent and safe field operations, reinforced by established procedures to follow and central technical support in case of need.

Premium Response



With Vertiv you can count on an extensive supply of critical parts plus crash-kits ready for deployment, and on service engineers that can respond to requests in record time. To do so, they can rely on a solid knowledge-base, and established escalation procedures valid across the regions. In addition, they can also benefit from advanced incident management, and widespread presence of Service Centres all enabling them to deliver premium restoration capabilities.

Supporting Your Business Around the Globe



Regular service of critical equipment supports maximum uptime and reduces total cost of ownership. A service programme ensures timely and proactive maintenance for avoiding unexpected, costly equipment downtime and enables optimal equipment operation. Vertiv™ service programmes cover all technologies and can be tailored to suit individual business needs.



Vertiv deep infrastructure expertise is amplified by field data and analytics, enabling data-based services such as Advanced Incident Management and Condition Based Maintenance. These services complement our portfolio providing additional insight into operating trends allowing informed decision and minimising operational.

Vertiv's AI Load Management Solutions for Data Centers

Evolving Critical Power Needs

As artificial intelligence (AI) advances, it imposes new demands on critical power infrastructure. This shift requires innovative solutions to handle higher power density servers, spiky and dynamic AI power loads, and the integration of liquid cooling systems with very low thermal inertia. Traditional power sources are becoming constrained, necessitating the adoption of sustainable alternatives. Vertiv addresses these evolving needs with resilient solutions designed to minimize the impact of single-point failures and support distributed power protection.

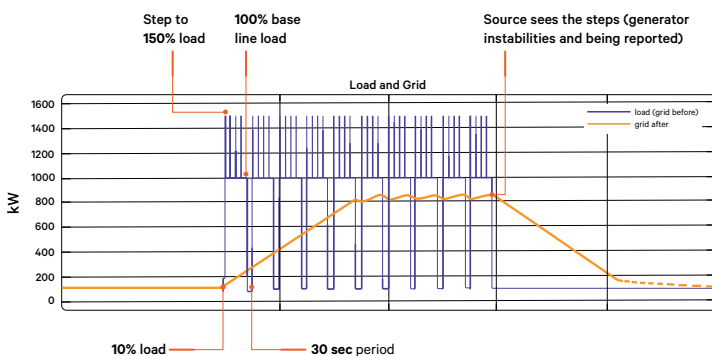

Impact of AI applications on critical infrastructure

With the forecast growth in rack densities for AI and high-performance computing (HPC) applications, Vertiv is developing solutions designed to withstand higher voltages, manage spiky AI loads and provide power protection for liquid cooling systems. This includes increasing power converter block sizes and enhancing power distribution circuits to meet the demands of high-density racks.

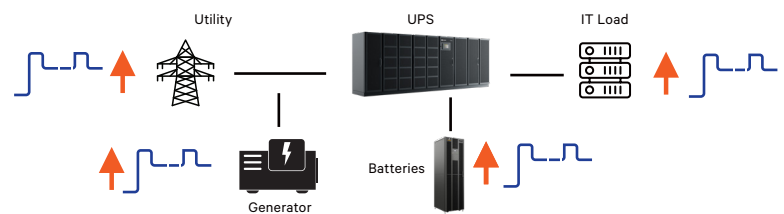

AI Loads Challenges

1. Power Fluctuations:

- Artificial intelligence (AI) has a unique load profile, characterized by rapidly fluctuating power demand and in turn Spiky/Fast dynamic loads.
- Power fluctuations may be reflected to the grid or to local generator leading to power quality and grid stability issues.
- Quick but repeated overloads as may cause voltage sags and equipment to switch to back up power.

2. Thermal Cycling:

- Thermal cycling of UPS components may impact equipment life.

3. Coolant Distribution Units (CDUs):

- Liquid cooling for GPU have very low thermal inertia (1-10 secs).

4. Power Density Requirements:

- Adopting higher voltage distribution to handle increasing power demands.

AI-Ready UPS solutions

Vertiv™ Large UPS systems are designed to manage AI applications efficiently. They handle rapid load changes without any performance degradation, ensuring continuous operation. Additionally, they protect the power source from sudden step loads and support increased rack power density by operating at higher voltages. This capability makes Vertiv Large UPS systems ideal for the demanding requirements of AI applications, providing reliable and stable power to maintain optimal performance.

Future-Proofing Data Centers

Vertiv's approach focuses on modular, scalable, and sustainable solutions to meet the growing demands of AI and high-density computing. By integrating advanced power management algorithms and supporting new energy sources, Vertiv ensures data centers can handle the dynamic and intensive workloads of the future.

For more detailed information on Vertiv's innovative solutions, visit our [AI Hub](#).

Enhance Your Power Reliability with Distributed Battery Systems

Uninterrupted power supply is essential for maintaining the seamless operation of critical applications, especially in large-scale data centers. At Vertiv, we understand the pivotal role that a resilient UPS system plays in protecting your electronic equipment from power disruptions, blackouts, and voltage spikes. Our advanced distributed battery systems are designed to enhance the reliability and efficiency of your UPS systems, ensuring continuous power quality and availability.

Why Choose Distributed Battery Systems?

- 1. Unmatched Fault Tolerance:** Distributed battery systems decentralize battery modules, allowing for effective fault isolation and management. This design ensures that even if one module encounters an issue, the remaining modules continue to provide uninterrupted power, significantly reducing the risk of complete system failures.
- 2. Scalability and Flexibility:** Our distributed systems are easily scalable, enabling you to add more modules as your power needs grow. This flexibility provides a cost-effective path for scaling your power infrastructure, making it adaptable to evolving requirements.
- 3. Maintenance Efficiency:** With distributed battery systems, maintenance can be performed on individual modules without disrupting the overall system. This approach minimizes downtime and ensures that your critical operations remain uninterrupted.
- 4. Enhanced System Availability:** Distributed battery systems guarantee continuous power supply, which is crucial for mission-critical applications. By reducing the likelihood of complete system outages, our systems enhance overall availability and reliability, ensuring your operations are always protected.

Tailored for Mission-Critical Environments: At Vertiv, we design our solutions with your most critical power scenarios in mind. Our distributed battery systems integrate seamlessly with modular UPS designs, offering the highest levels of fault tolerance and maintenance efficiency. Ensure your power infrastructure is as resilient as your business demands with Vertiv's distributed battery systems.

EnergyCore Battery Cabinet

The Vertiv™ EnergyCore is the first optimized battery cabinet designed by datacenter experts for data center users. The Vertiv EnergyCore system has successfully completed a UL 9540A fire test. According to NFPA 855's ESS installation standards, when successfully completing a UL9540A test, three feet (92cm) spacing requirements between racks can be waived by the Authorities Having Jurisdiction (AHJ).

The Vertiv EnergyCore is engineered to provide safe, reliable, and cost effective energy that improves critical infrastructure performance over traditional valve-regulated lead-acid systems.

Not only do users enjoy the longer life, more cycles and fewer replacements of this system, they also benefit from its compact, smaller size and lower weight. These advantages directly impact an impressive total cost of ownership experience.



Vertiv™ EnergyCore Battery Cabinet

Reduce Battery Replacement Cycles



VRLA = valve regulated lead-acid
LIB = data center lithium-ion

Fewer Facility Disruptions
Lower Total Cost of Ownership

Overview

Lithium-ion battery, as one of the most influential technical breakthroughs in the last decade, has transformed our lifestyle and reshapes the world by powering from our cell phones and notepads to our new e-cars and renewable power plants. It will be the next generation batteries to power our UPS and datacenters.

Vertiv's innovative mindset and early experience with lithium-ion batteries has helped many organizations achieve their infrastructure goals.

Ideally Suited For

- New data centers
- Cloud, colo, hosting facilities
- Enterprise data centers
- UPS energy storage
- Replacements to lead-acid batteries

Compliant

- UL 1973
- UL 9540A Tested
- UL 9540

Qualified for immediate use with most current and legacy three phase Vertiv™ Liebert® UPS systems.



Technical Data Vertiv™ Trinergy™

1500 kW 400V
2000 kW 400V

Primary Input

Nominal mains input voltage / voltage range ⁽⁶⁾	(V)	400 (340 to 460), 3Ph+PE or 3Ph+N+PE	
Nominal frequency / frequency tolerance	(Hz)	Selectable 50 or 60	
Input Power Factor		≥ 0.99	
Input current distortion (THDi)	(%)	≤3	
Walk in/soft start	(seconds)	15 (1 to 90 selectable)	
Rectifier Hold-Off	(seconds)	0 (0 to 240 selectable)	
Inrush current / I _{max} input		≤1	

Inverter Output

Nominal apparent power	(kVA)	1500	2000
Nominal active power	(kW)	1500	2000
Nominal output current @ nominal voltage 480V	(A)	2165	2887
Maximum output active power @ 35°C	(kW)	1500	2000
Inverter Overload Capacity ⁽⁵⁾		110% continuous, 125% for 10mins, 150% for 1min	
Nominal output voltage	(V)	400 (380 to 415 selectable), 3Ph+PE or 3Ph+N+PE	
Nominal output frequency	(Hz)	Selectable 50 or 60	
Output load Power Factor without derating		0,7 leading - 0,4 lagging	
Voltage stability in steady state condition for input (AC & DC) variations and step load (0 to Nominal load)	(%)	±1	
Voltage stability in dynamic condition for input variation (AC & DC) and step load	(%)	Complies with IEC/EN 62040-3, Class 1	
Voltage stability in steady state for 100% load imbalance (0, 0, 100)	(%)	±3	
Frequency slew rate	(Hz/sec)	<1 default (selectable up to 5 Hz)	
Output voltage distortion at nominal linear load	(%)	<1.5	
Output voltage distortion @ reference non linear load as for IEC/EN 62040-3	(%)	<5	
Load crest factor handled without derating the UPS	(I _{pk} /I _{rms})	3:1	
Phase angle precision with balanced loads	(degrees)	±1	
Phase angle precision with 100% unbalanced loads	(degrees)	±2	

DC Source

Battery types		VRLA, Li-Ion, Ni-Zn	
Permissible battery voltage range	(V)	397 to 700	
Recommended n° of VRLA cells:		240-300	
Float voltage for VRLA @ 20 °C	(V/cell)	2.27	
End cell voltage for VRLA	(V/cell)	1.65	
Float voltage stability in steady state condition	(%)	≤1	
DC ripple voltage without battery	(%)	≤1	

Optimum battery temperature	(°C)	15 to 25	
Battery recharge current setting range for 240cells @ 400V input voltage & maximum output load (PF=1) ⁽⁴⁾	(A)	437	583
Static Bypass			
Nominal bypass input voltage ⁽⁶⁾	(V)	400 (380 to 415 selectable), 3Ph+PE or 3Ph+N+PE	
Nominal bypass input voltage range ⁽⁶⁾	(%)	±10 (5 to 15 selectable)	
Nominal output frequency	(Hz)	Selectable 50 or 60	
Frequency range	(%)	±1 (2, 3, 4 selectable)	
Maximum static bypass overload capacity:			
For 10 minutes	(%)	125	
For 1 minute	(%)	150	
Transfer time whit inverter synchronous to bypass:			
Inverter to Bypass	(ms)	No break	
Bypass to Inverter	(ms)	<2ms	
General System Data			
AC/AC efficiency VFI without charging current @ nominal input conditions ⁽³⁾⁽⁴⁾ with resistive load:		≥ 97%	
AC/AC efficiency with dynamic online (VI) without charging current @ nominal input conditions ⁽³⁾⁽⁴⁾ with maximum resistive load:		≥ 99%	
AC/AC efficiency in Intelligent ECO mode without charging current @ nominal input conditions ⁽³⁾⁽⁴⁾ with maximum resistive load:		≥ 99%	
Prospective short circuit current Icp with bypass fuses	(kAIC)	Up to 200	
Heat dissipation @ nominal input conditions and nominal output load:			
Float Mode VFI	(BTU/h)	207702	276937
	(kW)	60.9	81.2
Float Mode VFD	(BTU/h)	67410	89880
	(kW)	19.8	26.4
Mechanical dimensions:			
Height	(mm)	2013	
Width	(mm)	5111 ⁽⁷⁾	5711
Depth	(mm)	1048	
Net Weight	(kg)	4854 ⁽⁷⁾	5454
Noise @ 1 meter ⁽³⁾⁽⁴⁾ as per ISO 7779/3746 at full load	(dBA ± 2dBA)	68	68
Protection degree with open doors		IP20	
Fame colour (RAL scale)		7021	
Cable entry		Top/Bottom	
Service Access		Front and Top	
Access		Front and Top (no rear access required)	
Cooling		Forced Ventilation, front air intake, top air outlet	

Environmental

Location		Indoor (free from corrosive gases and conductive dust)
Operating Temperature	(°C)	0 to 50 with automatic derating from 40°C
Maximum relative humidity @ 20 °C (non condensing)	(%)	Up to 95 with humidity control and correction
Max altitude above sea level without derating	(m)	1000 (for higher altitudes complies with IEC/EN 62040-3)
Immunity to electrical interference		IEC / EN / BS 62040-2
EMC Class		IEN / EN 62040-2 Class C3
Environmental Aspects		IEC/ EN/ 62040-4
Classification according to IEC/EN 62040-3		VFI-SS-111
Options		Dynamic Grid Support
		Integrated Backfeed Protection Device
		DC Ground Fault Detection
		EPO Push Button
		Flange connections
		Vertiv™ Life™ Services Remote Diagnostic and Preventive Monitoring
		Battery Trip Option
Network Protocols with Monitoring Card		Modbus TCP
		BACnet/WS
		BACnet/IP
		SNMP v.1, v.3, IPv6

Note:

(1) Short circuit values depend on UPS rating, please contact Vertiv Technical Support for more information

(2) Values specified for single unit. Units in parallel may have different values due to contribution of the parallel connections. Please contact Vertiv Technical Support for more information

(3) For tolerance see IEC/EN 60146-1-1 or DIN VDE 0558. The data refer to 25°C ambient temperature

(4) At nominal voltage, nominal frequency





(5) Value obtained at 25°C

(6) In case of a split input configuration, the primary input and the bypass input must have a common neutral reference



(7) 1500kW CE version will be available in next releases starting from February 2025 with optimized width 4600 mm and weight 4454 kg

Global presence for a close partnership. Everywhere.

Global AC Power Sites

-  4 Laboratories and R&D
-  5 Manufacturing Sites
-  3 Witness Test Sites
-  9 Main Training Centers
-  Global Network of Regional Sales and Service Representatives

AC Power Highlights

-  **100K+**
Square meter of manufacturing space
-  **Up to 12MW**
Available for witness tests
-  **92k**
Hours of technical training each year

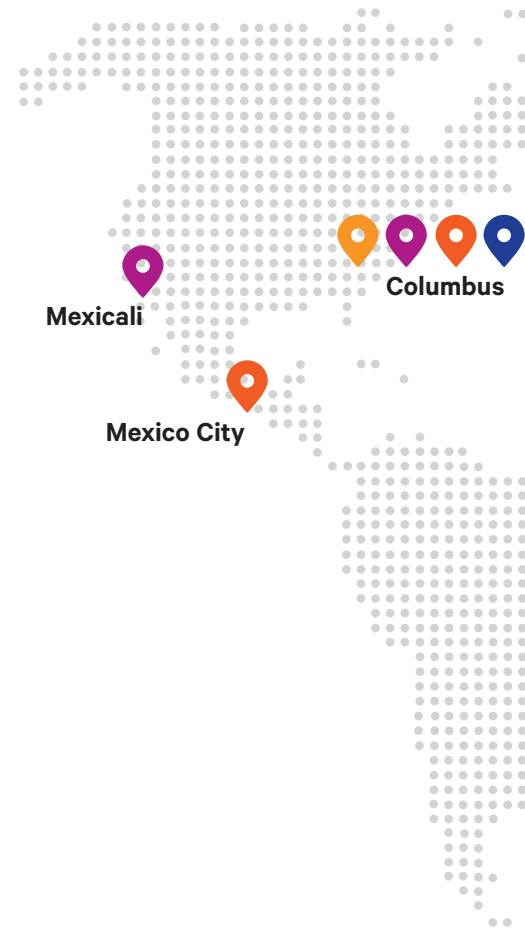

Main Witness Test and Customer Experience Center sites.

Vertiv™ state-of-the-art Customer Experience Centers enable our customers to experience first-hand a wide variety of data center technologies, including **demo, standard, customized and remote virtual FAT experiences**, supported by constant consultation from R&D and engineering specialists.

Bologna, Italy - Customer Experience Center

- **800+** Customers every year
- From **50+** countries
- **10+** people dedicated
- **1700 m²** Witness Testing
- **650 m²** Showroom
- **650 m²** Academy
- **5** testing stations, each providing up to 3.5 MVA of capacity = total 4 MW
- **140+** witness test every year
- **400+** UPS systems tested each year
- **Up to 4000 A** simultaneous test at full load



Delaware, US - Power Test Center

- **4,000+** m², including **280+** m² customer observation suite
- **40** testing bays, each containing multiple distinct test stations - total 12 MW available
- **100+** tour-factory witness test each year



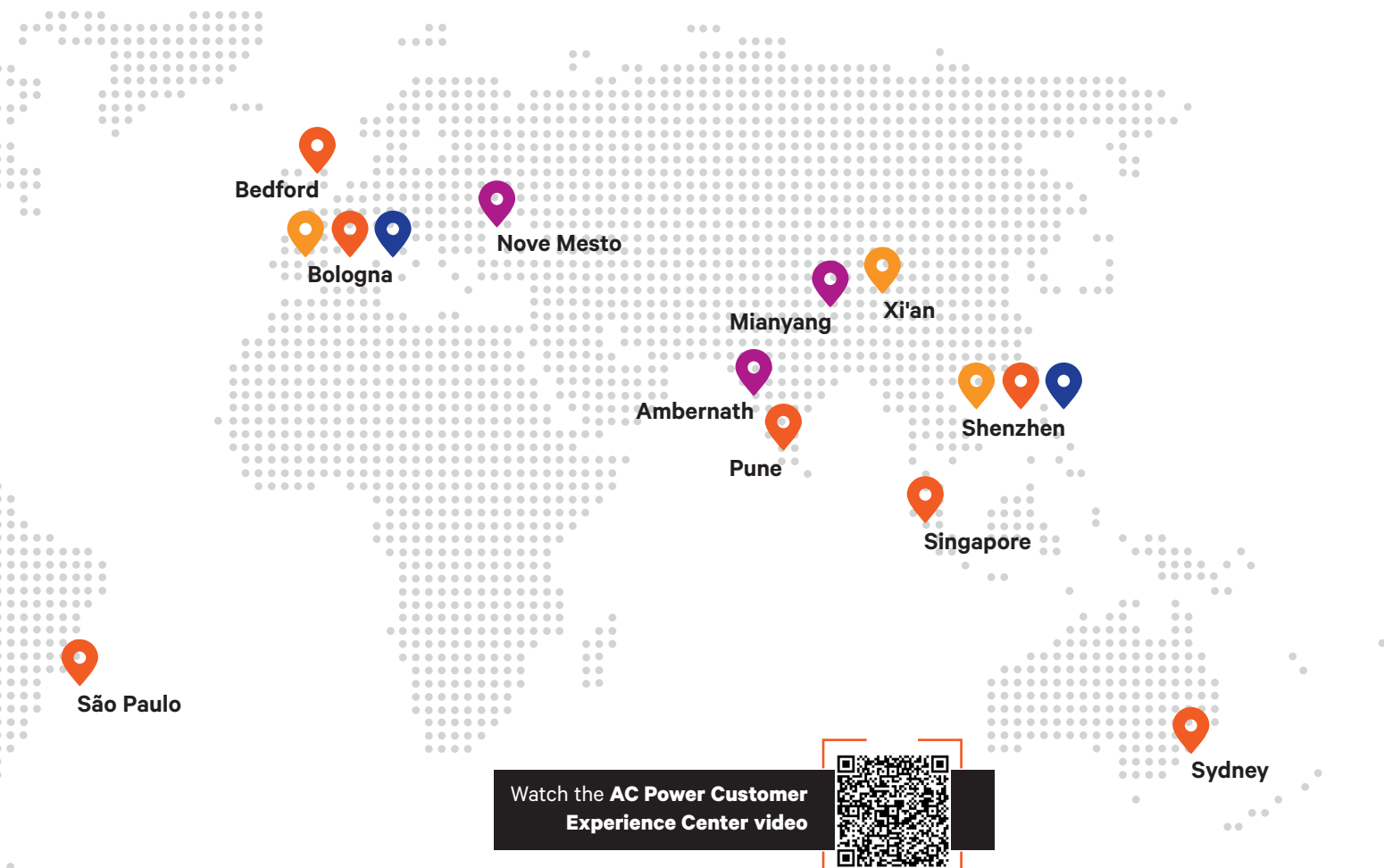

Watch the **AC Power Customer Experience Center** video

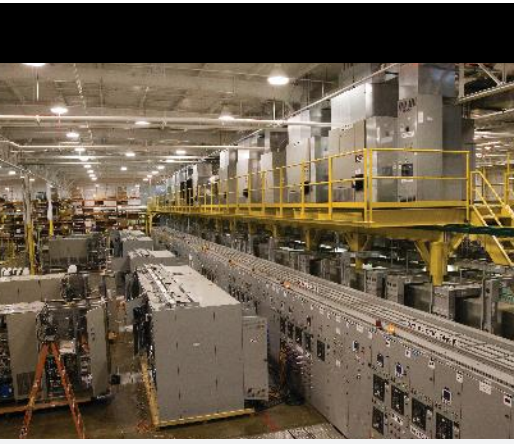

Mianyang, China - Power Test Center

- **100+** Customers every year
- From **25+** countries
- **2** people dedicated
- **180 m²** Witness Testing
- **60 m²** Showroom
- **2** testing stations, each providing up to 1.2 MVA of capacity = total 2.5 MW
- **40+** witness test every year
- **100+** UPS systems tested each year
- **Up to 1.8 A** simultaneous test at full load



