



eSure™

MPPT Solar Converter Module

User Manual

Specification Number: 1S484300E4

Model Number: S48-4300E4

The information contained in this document is subject to change without notice and may not be suitable for all applications. While every precaution has been taken to ensure the accuracy and completeness of this document, Vertiv assumes no responsibility and disclaims all liability for damages resulting from use of this information or for any errors or omissions. Refer to other local practices or building codes as applicable for the correct methods, tools, and materials to be used in performing procedures not specifically described in this document.

The products covered by this instruction manual are manufactured and/or sold by Vertiv. This document is the property of Vertiv and contains confidential and proprietary information owned by Vertiv. Any copying, use or disclosure of it without the written permission of Vertiv is strictly prohibited.

Names of companies and products are trademarks or registered trademarks of the respective companies. Any questions regarding usage of trademark names should be directed to the original manufacturer.

Technical Support Site

If you encounter any installation or operational issues with your product, check the pertinent section of this manual to see if the issue can be resolved by following outlined procedures.

Visit <https://www.vertiv.com/support/> for additional assistance.

TABLE OF CONTENTS

Admonishments Used in this Document	iv
Important Safety Instructions	v
Safety Admonishments Definitions.....	v
General Safety.....	v
Voltages.....	v
DC Input Voltages.....	v
DC Output and Battery Voltages.....	v
Hazardous Voltage.....	v
Handling Equipment Containing Static Sensitive Components.....	v
Static Warning	vi
1 Introduction	1
1.1 Overview.....	1
1.2 Specifications.....	1
1.2.1 DC Output Ratings.....	1
1.2.2 DC Input Ratings.....	4
1.2.3 Environmental Ratings.....	6
1.2.4 Compliance Information.....	6
1.2.5 Standard Features.....	7
1.2.6 Mechanical Specifications.....	10
2 Operation	10
2.1 DC Input Protection Device Requirements/Recommendations.....	10
2.2 Local Indicators.....	10
2.3 Solar Converter High Voltage Shutdown and Lockout Restart.....	11
2.4 Solar Converter Current Limit.....	12
2.5 Installing Solar Converters.....	12
3 Troubleshooting and Repair	13
3.1 Troubleshooting.....	13
3.1.1 Solar Converter Current Sharing Imbalance.....	13
3.1.2 Solar Converter Fault Symptoms and Troubleshooting.....	13
3.2 Replacement Procedures.....	14
3.2.1 Solar Converter Module Replacement.....	14
3.2.2 Solar Converter Fan Replacement.....	15

Admonishments Used in this Document



DANGER! Warns of a hazard the reader **will** be exposed to that will **likely** result in death or serious injury if not avoided. (ANSI, OSHA)



WARNING! Warns of a potential hazard the reader **may** be exposed to that **could** result in death or serious injury if not avoided. This admonition is not used for situations that pose a risk only to equipment, software, data, or service. (ANSI)



CAUTION! Warns of a potential hazard the reader **may** be exposed to that **could** result in minor or moderate injury if not avoided. (ANSI, OSHA) This admonition is not used for situations that pose a risk only to equipment, data, or service, even if such use appears to be permitted in some of the applicable standards. (OSHA)



ALERT! Alerts the reader to an action that **must be avoided** in order to protect equipment, software, data, or service. (ISO)



ALERT! Alerts the reader to an action that **must be performed** in order to prevent equipment damage, software corruption, data loss, or service interruption. (ISO)



FIRE SAFETY! Informs the reader of fire safety information, reminders, precautions, or policies, or of the locations of fire-fighting and fire-safety equipment. (ISO)



SAFETY! Informs the reader of general safety information, reminders, precautions, or policies not related to a particular source of hazard or to fire safety. (ISO, ANSI, OSHA)

Important Safety Instructions

Safety Admonishments Definitions

Definitions of the safety admonishments used in this document are listed under “Admonishments Used in this Document” on page iv.

General Safety



DANGER! YOU MUST FOLLOW APPROVED SAFETY PROCEDURES.

Performing the following procedures may expose you to hazards. These procedures should be performed by qualified technicians familiar with the hazards associated with this type of equipment. These hazards may include shock, energy, and/or burns. To avoid these hazards:

- a) The tasks should be performed in the order indicated.
- b) Remove watches, rings, and other metal objects.
- c) Prior to contacting any uninsulated surface or termination, use a voltmeter to verify that no voltage or the expected voltage is present. Check for voltage with DC voltmeter prior to making contact.
- d) Wear eye protection.
- e) Use certified and well maintained insulated tools. Use double insulated tools appropriately rated for the work to be performed.

Voltages

DC Input Voltages



DANGER! This system operates from DC input voltage capable of producing fatal electrical shock.

DC Output and Battery Voltages



DANGER! This system produces DC power and may have a battery source connected to it. Although the DC voltage is not hazardously high, the solar converters and/or battery can deliver large amounts of current. Exercise extreme caution not to inadvertently contact or have any tool inadvertently contact an output terminal or battery terminal or exposed wire connected to an output terminal or battery terminal. NEVER allow a metal object, such as a tool, to contact more than one termination or battery terminal at a time, or to simultaneously contact a termination or battery terminal and a grounded object. Even a momentary short circuit can cause sparking, explosion, and injury.

Hazardous Voltage



DANGER! HAZARD OF ELECTRICAL SHOCK.

More than one disconnect may be required to de-energize the system before servicing.

Handling Equipment Containing Static Sensitive Components



ALERT! Installation or removal of equipment containing static sensitive components requires careful handling. Before handling any equipment containing static sensitive components, read and follow the instructions under “Static Warning” on page vi.

Static Warning



This equipment contains static sensitive components. The warnings listed below must be observed to prevent damage to these components. Disregarding any of these warnings may result in personal injury or damage to the equipment.

1. Strictly adhere to the procedures provided in this document.
2. Before touching any equipment containing static sensitive components, discharge all static electricity from yourself by wearing a wrist strap grounded through a one megohm resistor. Some wrist straps have a built-in one megohm resistor; no external resistor is necessary. Read and follow wrist strap manufacturer's instructions outlining use of a specific wrist strap.
3. Do not touch traces or components on equipment containing static sensitive components. Handle equipment containing static sensitive components only by the edges that do not have connector pads.
4. After removing equipment containing static sensitive components, place the equipment only on static dissipative surfaces such as conductive foam or ESD bag. Do not use ordinary Styrofoam or ordinary plastic.
5. Store and ship equipment containing static sensitive components only in static shielding containers.
6. If necessary to repair equipment containing static sensitive components, wear an appropriately grounded wrist strap, work on a conductive surface, use a grounded soldering iron, and use grounded test equipment.

1 Introduction

1.1 Overview

The Vertiv™ eSure™ MPPT (Maximum Power Point Tracking) Solar Converter provides load power, battery float current, and battery recharge current during normal operating conditions. The solar converter is a constant power design. The solar converter is rated at its maximum output power. This means that, within the normal operating ambient temperature range and input voltage range, the maximum available output power is a constant 4320 W. Within these ranges, the solar converter output power operates in one of three modes, depending upon load demands. Transition between modes is completely automatic. If ambient temperature rises above or input voltage falls below acceptable values, the solar converter continues to operate but at derated output power levels.

- Constant Voltage Mode: For any initial output voltage setting from 53 VDC to 58.5 VDC, output voltage remains constant regardless of load. This is the normal operating condition, in which loads are being supplied and batteries are float charged. Solar converters operate in the Constant Voltage Mode unless load increases to the point where the product of load current and output voltage is approximately 4320 W.
- Constant Power Mode: As load increases above approximately 4320 W (non-adjustable), output current continues to increase, but output voltage decreases as required to maintain constant output power. Solar converters operate in the Constant Power Mode unless load continues to increase to the point where the current limit setting is reached.
- Constant Current Mode: If load increases to the current limit setting, output voltage decreases linearly to maintain output current at the current limit setting.

1.2 Specifications

1.2.1 DC Output Ratings



NOTE! A current limitation can be set by the User and the output voltage level is set through the controller.

- Voltage: Nominal -48 VDC, positive ground. Output voltage is adjustable from -38 VDC to -58.5 VDC via the associated controller. Refer to Figure 1.1. The lower limit is 38 VDC.
- Output Power: 4320 W @ 200 VDC to 420 VDC input and 53.5 VDC output.
- Output Current: 81.5 A @ 53 VDC.
- Output Characteristics: Refer to Figure 1.1 for a graph of output voltage vs. output current.

Figure 1.1 Output Voltage vs. Output Current

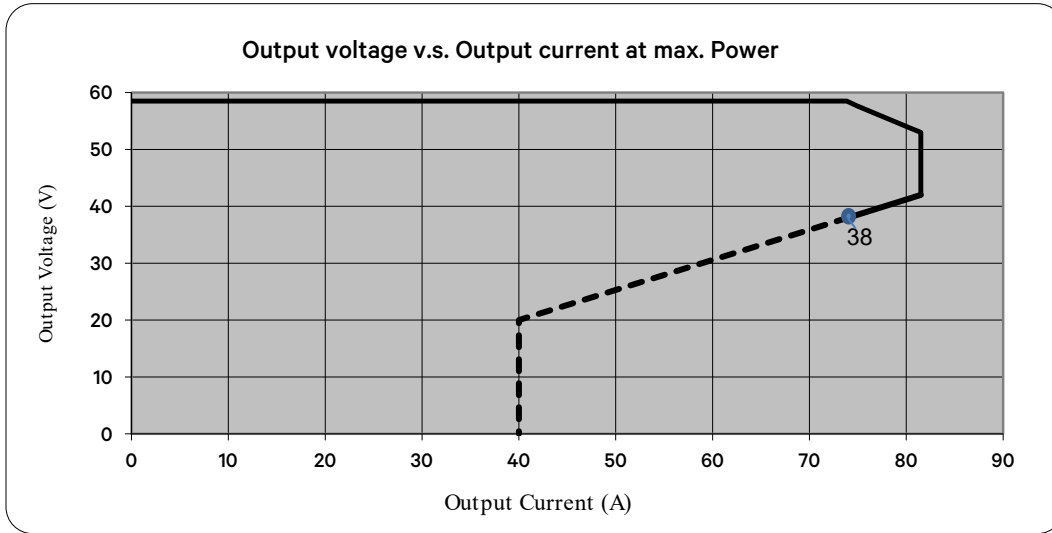

- Power Derating Based on Input Voltage:** The solar converter power varies with changes in input voltage and output voltage. It uses an advanced power limitation method. The lower input threshold is 70 VDC. The solar converter can provide its maximum rated power (4320 W) as long as the input voltage is within the range of 200 VDC to 420 VDC. Below 200 VDC, and down to 70 VDC, the solar converter will continue to operate normally, but will be in a power derating mode. The relationship between the output power and input voltage is illustrated in Figure 1.2.

Figure 1.2 Power Derating Based on Input Voltage

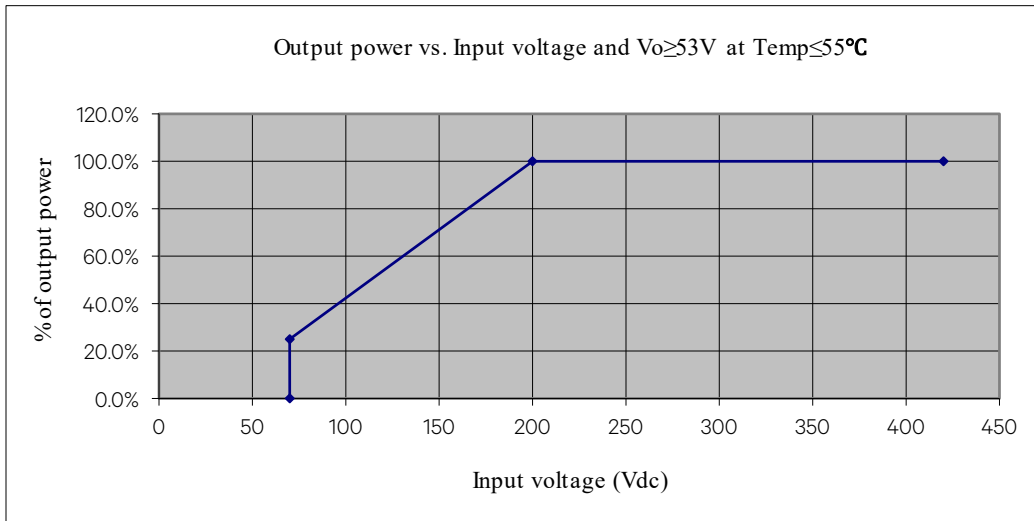

- Power Derating Based on Temperature:** The solar converter delivers full power when operating at an ambient temperature of +55 °C (+131 °F) or below. Each solar converter continuously monitors the ambient temperature surrounding the power conversion circuit. If this temperature for any reason (such as a high ambient temperature) increases above approximately +55 °C (+131 °F), the solar converter will not shut down. Rather, the solar converter limits its maximum output power to maintain the temperature of the power conversion circuit within design parameters. Operation between +55 °C (+131 °F) and +80 °C (+176 °F) will result in output power being decreased. Full power capability is restored when the temperature decreases to below approximately +55 °C (+131 °F). Refer to Figure 1.3 to view the relationship between the output power and the ambient temperature.

Other power rating values are as follows (refer to Figure 1.3):

- a) At an ambient temperature of +65 °C (+149 °F), the power delivered by the solar converter is 3400 W.
- b) At an ambient temperature of +75 °C (+167 °F), the power delivered by the solar converter is 2800 W.



WARNING! The module is rated for continuous operation at full output power up to +55 °C (+131 °F). Operation between +55 °C (+131 °F) and +80 °C (+176 °F) will result in output power decrease. Operation above +80 °C (+176 °F) is considered abnormal and should be used on a temporary¹ basis only.

- ¹ Temporary Operation at Abnormal Temperature: Temporary operation is defined as a period of not more than eight consecutive hours per day, and a total of not more than 15 days in a year. (This refers to a total of 120 hours in any given year, but no more than 15 occurrences in that one-year period.)

Figure 1.3 Power Derating Based on Temperature

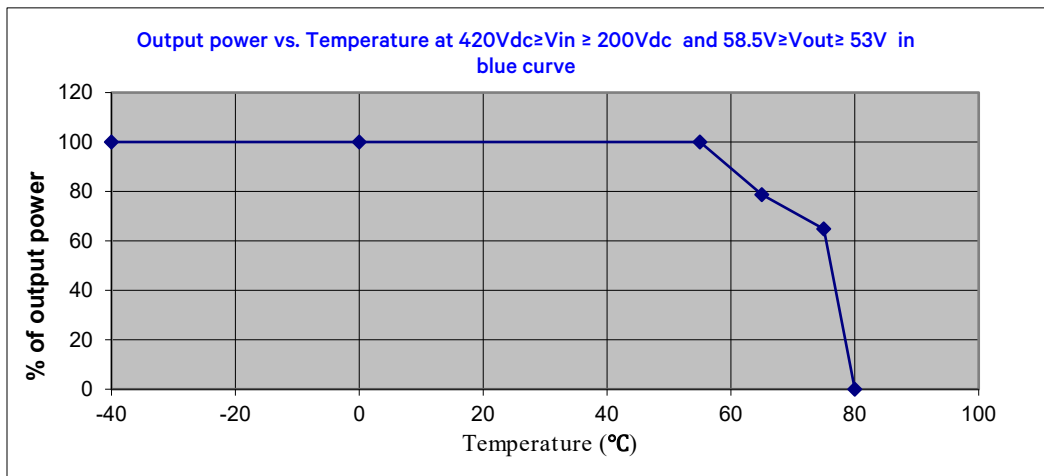

NOTE! 4320 W @ +55 °C (+131 °F) 420 VDC ≥ Vin ≥ 200 VDC and 58.5 VDC ≥ Vout ≥ 53 VDC.

- Regulation:
 - a) Static: Steady state regulation is ±0.6% as controlled within the solar converter for any and all combinations of load from no load to full load and input voltage at a constant ambient temperature. The associated system controller may provide increased regulation.
 - b) Dynamic: Response time ≤200 us and overshoot ≤5% for load changes at 50%-25%-50% and 50%-75%-50% rated output current. The dynamic response is required at rated input and rated output voltage.
- Filtering:
 - a) Psophometric Noise: ≤2 mV at 300 Hz to 3400 Hz, at nominal input (306 VDC), output (53.5 VDC), and load >5% according to YD/T 2321-2020 (China).
 - b) Peak-Peak Voltage: ≤200 mV at 0 MHz to 20 MHz, at normal output voltage with 50% and 100% rated current. better to be ≤100 mV at 0 MHz to 20 MHz and normal output voltage.
 - c) Wideband Noise Voltages: ≤50 mV at 3.4 kHz to 150 kHz and ≤20 mV at 0.15 MHz to 30 MHz at normal output voltage with 50% and 100% rated current.

1.2.2 DC Input Ratings

- Nominal Input Voltage: 200 VDC to 400 VDC (if no special mention, the input voltage of below items should be nominal).
Operating Range: 70 VDC to 420 VDC.
- Maximum Input Current: 24 A.
- Inrush Current: The peak value of the input inrush current shall not exceed 1.5 times of the peak value of the maximum steady-state input current at 25 °C and shall not trigger the unit’s internal input fault protection device(s). Charging of input X and Y filter capacitors shall be ignored.
- Input Current Fuse: The current fuse is 500 VDC / 30A.
- MPPT Precision: >99% when the output power more than 400 W.
- Input Data
 - a) Efficiency: Refer to Table 1.1 and Figure 1.4.

Figure 1.4 Efficiency Curve

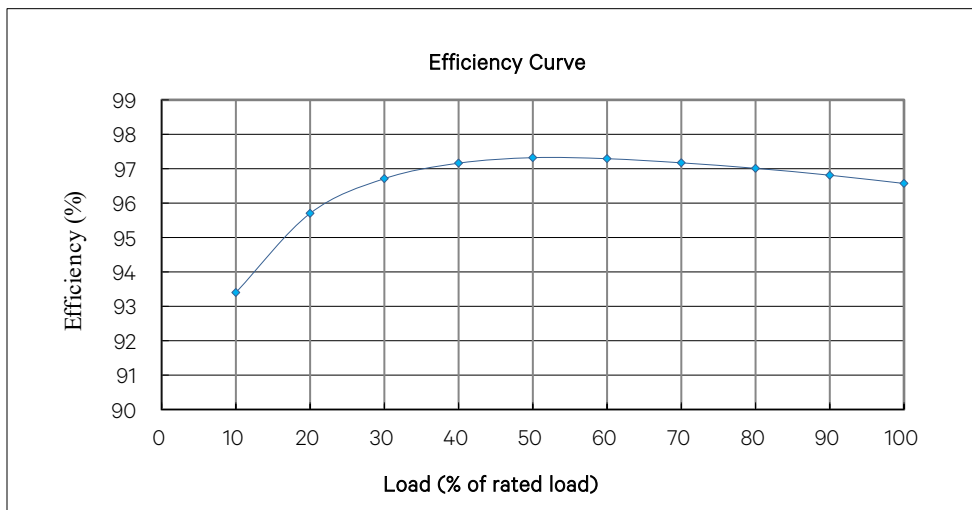

Table 1.1 Typical Input Data in 360 VDC Input

Nominal Input Voltage	Percent of Full Load	Input Current (Amperes)	Input Watts	Efficiency (%)	Heat Dissipation (BTU/HR)
360	10%	7.5	428.7	93.40	96.51
	20%	15	837.9	95.70	123.08
	30%	22.5	1243.8	96.71	139.80
	40%	30	1650.7	97.16	159.96
	50%	37.5	2059.8	97.32	188.73
	60%	45	2471.6	97.29	228.75
	70%	52.5	2886.2	97.17	278.56
	80%	60	3303	97.01	337.23
	90%	67.5	3722.5	96.81	405.62
	100%	75	4145	96.57	485.64
306	10%	7.5	428.2	93.55	94.31
	20%	15	836.8	95.83	118.94
	30%	22.5	1242.3	96.85	133.74
	40%	30	1650.7	97.17	159.37
	50%	37.5	2060.9	97.27	192.11
	60%	45	2473.7	97.22	235.40
	70%	52.5	2888.7	97.10	286.37
	80%	60	3306.1	96.92	347.21
	90%	67.5	3726.5	96.71	418.22
	100%	75	4149.8	96.47	500.30
200	10%	7.5	428.5	93.50	95.05
	20%	15	834.9	96.06	112.18
	30%	22.5	1242.6	96.83	134.58
	40%	30	1652.5	97.07	165.51
	50%	37.5	2065.5	97.05	207.61
	60%	45	2481	96.93	259.88
	70%	52.5	2900.5	96.71	325.20
	80%	60	3322.8	96.46	401.92
	90%	67.5	3748.7	96.16	491.85
	100%	75	4179.7	95.80	598.93

1.2.3 Environmental Ratings

- Operating Ambient Temperature Range:
 - a) +55 °C (+131 °F) to +80 °C (+176 °F) with derating output.
 - b) -40 °C (-40 °F) to +55 °C (+131 °F) with full power performance.
- Temperature Coefficient: 0.02% per degrees Celsius. (According to YD/T 731)
- Storage Ambient Temperature Range: -40 °C (-40 °F) to +75 °C (+167 °F) dry and non-condensing.
- Relative Humidity: This solar converter is capable of operating in an ambient relative humidity range of 0% to 95%, non-condensing.
- Altitude: 3000 m (9842 ft) at full power (power derates above 3000m as a rate of -3°C per 305m).
- Surge Protection: Compliance with EN61000-4-5 (4 kV Line to Line, 4 kV Line to Earth). Capable of withstanding surges per ANSI/IEEE C 62.41 1999 Category B3 across the input terminals.



NOTE! This level of protection is a widely used standard for telecommunications power equipment. As with all such equipment, it is the end user's responsibility to provide an adequately sized Surge Suppression Device at the commercial power service entrance of the building that reduces all incoming surges to levels below the classes/categories stated for the equipment.

- Ventilation Requirements: The solar converters are fan cooled and utilize front to back forced ventilation. A solar converter must be mounted so ventilating openings are not blocked and temperature of the air entering the solar converter does not exceed the Operating Ambient Temperature Range stated above.
- Single Solar Converter Audible Noise: At 25 °C ≤51 dB(A) with 306Vdc input voltage and rated load output. Measurement made at 1.0 m distance in front of solar converter and at same horizontal line of the middle of solar converter.
- High Voltage Category: II
- Power Distribution System: TN/TT/IT



NOTE! The solar converter module is recommended to be used in an environment with Pollution of Degree 2 or less. Pollution Degree 2 applies where there is only non-conductive pollution that might temporarily become conductive due to occasional condensation (such as the office environment).

1.2.4 Compliance Information

- EMC: Conducted emission DC input and output side for ETSI EN 300 386 V1.6.1, class A. EN55032, Class A conducted, and Class B radiated.
- EMI Load Range: 5% to 100%.
- Safety: UL 62368-1 C22.2 NO. 62368-1, EN 62368-1, IEC 62368-1.

1.2.5 Standard Features

- Type of Power Conversion Circuit: High frequency.
- Energy Meter Function: The solar converter provides the accumulated energy delivered.
- Constant Voltage Mode: For any initial output voltage setting from 53 VDC to 58.5 VDC, output voltage remains constant regardless of load. This is the normal operating condition, in which loads are being supplied and batteries are float charged. Solar converters operate in the Constant Voltage Mode unless load increases to the point where the product of load current and output voltage is approximately 4320 W.
- Constant Power Mode: As load increases above approximately 4320 W (non-adjustable), output current continues to increase, but output voltage decreases as required to maintain constant output power. Solar converters operate in the Constant Power Mode unless load continues to increase to the point where the current limit setting is reached.
- Constant Current Mode: If load increases to the current limit setting, output voltage decreases linearly to maintain output current at the current limit setting.
- Two Work Mode: The solar converter has two working modes. When the input power is greater than the output power, the solar converter can switch from MPPT mode to DC/DC mode. Otherwise, when the input side power is less than the output power, the solar converter enters the MPPT working mode to realize the maximum power point tracking of the solar curve.
- Input Protection:
 - a) Input Over/Under Voltage Protection: The solar converter will shut down at low or high voltage input; based on the following voltage levels:
 1. Low Voltage Disable Point: 65 VDC, ± 5 V; hysteresis is 15 VDC for restart.
 2. High Voltage Disable Point: 427 VDC, ± 5 V; hysteresis is 15 VDC for restart.
 - b) Between 70 VDC and 200 VDC the output power will be derated linearly based on the input voltage as follows:
 1. At input voltage of 70 VDC with output >53 VDC, max output power is 1080 W.
 2. At input voltage of 200 VDC with output >53 VDC, max output power is 4320 W.
 - c) Input Fuse Protection: A non-user replaceable input fuse is located internal to the unit.
- Output Protection:
 - a) Overload / Reverse Current: The solar converter has a 50 A*3 fuse in the negative output DC bus. This fuse is not customer replaceable. The solar converter can be plugged into or pulled out of a shelf while operating, without damage or opening the fuse.
 - b) Current Limiting: The solar converter has a current limit function. The current limit point can be set between the range of 0 A to 81.5 A, adjustable via the controller, if enabled. The current limit accuracy is ± 3 A when the output voltage ranges from 38 V to 58.5 V. Below 38 VDC the current will fold back to 74 A, Refer to Figure 1.1.
 - c) Advanced Current Limit Function: The solar converter has an advanced Current Limit Function. When a short circuit occurs at the solar converter output terminals, the solar converter will keep its output current at a value below the maximum current limit set point. This function effectively protects the solar converter and the equipment connected to the solar converter. When the short circuit fault is cleared, the solar converter will automatically restore back to normal operation.

d) High Voltage Shutdown:

1. Adjustable Control: If solar converter output voltage exceeds an adjustable preset value and the solar converter is delivering more than 10% of its rated current, the solar converter shuts down. (Adjustable from 56 VDC to 59 VDC via the controller, when enabled. The restart hysteresis is 0.5 V \pm 0.1 V.)

One Converter will have two software settings (via controller):

1) Manual restart

2) Automatic restart attempt 5 seconds delay after HVSD and:

- After 100 times of software overvoltage, the converter needs to be manually restarted.
- Converters delivering <10% of output rating shall not shut down.
- Converters can be reset through power "on/off" cycle or by controller (s/w)
- After HVSD occurs, it will automatically restart after a delay of 5 seconds.

2. Backup: If solar converter output voltage exceeds 59.5 V \pm 0.5 V (non-adjustable) and the solar converter is delivering more than 10% of its rated current, the solar converter shuts down. The shutdown Converter shall also be able to receive a HVSD reset message from the controller to initiate a re-start.

If h/w over voltage is caused by one Converter fault, this Converter shall find it and turn off itself in 100ms. The other normal Converters shall not turn off when detecting overvoltage. If over voltage can't be solved by turn off the failure module, and the lasting time of h/w over voltage get to 5S, all converters can restart automatically.

- Over-Temperature Protection: The solar converter provides over temperature protection by derating output power and recovers automatically.
- Active Load Sharing: The solar converter uses advanced digital active load sharing technology that maintains balancing to within 5% of rated current.
- Hot Swappable: The solar converter is designed to be plug-and-play. The solar converter can be inserted or removed from a live DC power system with no damage. When the solar converter is plugged into the system, the system output voltage will not be affected.
- Ground Fault Array: When the solar converter starts, it will perform insulation detection on the solar input and detect the insulation resistance between the positive and negative input pairs of PE. If the impedance of any circuit is lower than the required protection threshold of IEC62109, the solar converter will report an insulation fault and upload the fault information to Controller, and the yellow light of the solar converter lights up at the same time; but the operation of the solar converter is not affected and will still start and run normally.
- Cooling: Each solar converter module contains a fan for front-to-back force air-cooling.
 - a) Fan Fault Protection: The solar converter module shuts down and its alarm indicator (red) flashes if the fan fails. Fan failure is detected and reported to controller. The fan is field replaceable.
 - b) Fan Control: Fan speed is continuously variable. When input voltage is within normal range, the built-in processor adjusts fan speed according to the solar converter module's internal temperature and output power. For example, a higher temperature or output power increases the fan speed. This feature can be disabled via the controller, allowing the fan to run at full speed regardless of temperature.
- Paralleling: Up to 80 solar converters can be connected in parallel in one system.

- **Communication Failure:** The solar converter's protection indicator (yellow) will flash should it experience a communication failure. The failure information will be reported to the controller and the controller will process the failure accordingly. During a communication failure, in order to protect the battery, the solar converter output voltage will automatically be adjusted as follows.
 - a) The solar converter default factory output voltage is 53.5 VDC.
 - b) Once power is applied to the solar converter and the solar converter is recognized by the controller, the output voltage is updated to the setting programmed into the controller.
 - c) If communications with an M530B/M530S controller is lost, solar converter output voltage goes to a default value programmed into the controller (this is a separate programmable parameter from the output voltage setting).
 - d) If communications with a M831A (Mini-NCU) or M830B (NCU) controller is lost, solar converter output voltage goes to the last communicated float output voltage setting in the controller (the last communicated float output voltage setting is stored in the solar converter).
 - e) The solar converter will revert to normal operation once normal communication to the controller is restored.
- **Solar Converter Output Current Imbalance:** When load sharing severe imbalance (output fuse open) and the output current drops to zero in average current >20% system, then the red fault indicator will illuminate.
- **Monitoring Function:** The solar converter has a built-in advanced DSP that monitors and controls the operation of the solar converter. The DSP also communicates with the controller in real time through the CAN bus. Table 1.2 lists the different commands and information exchanged between the solar converter and the controller.

Table 1.2 Exchange of Information between Solar Converter and Controller

Commands / signals that can be received by the solar converter module from the controller.	Information gathered by the controller from the solar converter module.
<ul style="list-style-type: none"> ● Turn On/Off ● Current Walk-in On/Off ● HVSD (High Voltage Shutdown) Reset ● Current Limit Adjustment ● Voltage Regulation 	<ul style="list-style-type: none"> ● Input Voltage ● Output Voltage ● Output Current ● Current Limit Setting ● Temperature ● Over Voltage Setting ● On/Off Status ● Fault Alarms, such as: <ul style="list-style-type: none"> HVSD Fan Fail ● Protection Alarms, such as: <ul style="list-style-type: none"> Input Voltage Protection Inner DC Bus Voltage Protection High Temperature Protection ● Thermal Derating ● Imbalance Output Current ● Address ● Code ● Date ● Software Version ● Hardware Version

- One Array to One Converter: To prevent MPPTs fighting for control, one solar array is connected to one solar converter. The system can support a maximum of 80 solar arrays to 80 converters, exceeding 345kW.



NOTE! *Though, the maximum number of parallel converters possible is 80, other limits on the system or controller may exist.*



NOTE! *When the input power of the solar converter is less than the output power, the solar converter will perform maximum power point tracking once every hour, and the solar converter will not provide energy for the module that performs MPPT scanning. When there are multiple MPPT modules in the system, all solar converters will not perform maximum power point tracking and scanning at the same time. They will be divided into 6 groups and perform maximum power point tracking and scanning in sequence. When the 1-hour time base is reached, starting from the first group, each group will be scanned in turn with an interval of 5 minutes.*

To ensure that user load power is not significantly affected.

1.2.6 Mechanical Specifications

- Dimensions:
 - a) Millimeters: 41.0 (Height) X 84.5 (Width) X 330 (Depth)
 - b) Inches: 1.6 (Height) X 3.3 (Width) X 13.0 (Depth)
- Weight: 2 kg (4.4 lbs)
- Indicators:
 - a) Power (Green LED)
 - b) Protection (Yellow LED)
 - c) Alarm (Red LED)

2 Operation

2.1 DC Input Protection Device Requirements/Recommendations

Refer to the system documentation supplied with the system the solar converter is installed in.

2.2 Local Indicators

Location and Identification: Refer to Figure 2.1.

Description: There are three (3) indicators located on the solar converter's front panel. The functions of these indicators are as shown in Table 2.1.



NOTE! *DC voltage must be present at the solar converter output terminals (from battery or an operating solar converter) or DC voltage at the input terminals.*

Figure 2.1 Local Indicator Locations

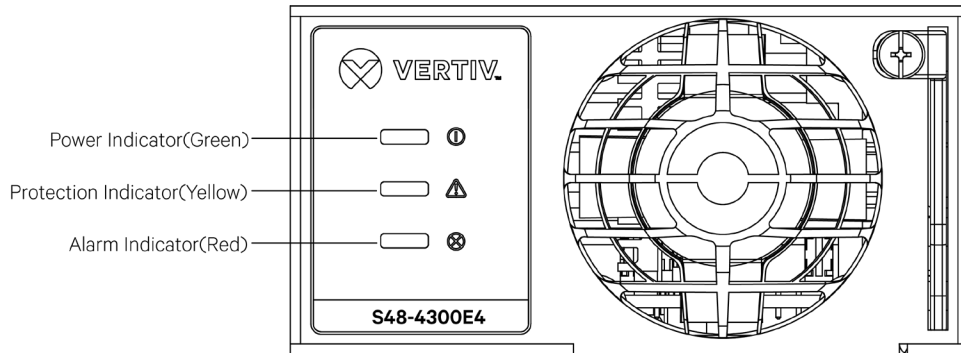





Table 2.1 Solar Converter Module Indicators

Indicator	Normal State	Alarm State	Alarm Cause
	Power (Green)	On	No input voltage. Internal input fuse open.
		Flashing	The solar converter is being identified by the controller.
	Protection (Yellow)	On	DC input under/over voltage. BOOST BUS output under/over voltage. Moderate load sharing imbalance. Converter over-temperature protection. Boost start failure. Controller setup close the input. Solar converter modules are operating in an output power derating mode (solar converters derate when module temperature rises above or input voltage falls below acceptable values). Unplug failure. Insulation detection fault.
		Flashing	Loss of communication with the controller (the solar converter can provide power). Input AC detection.
	Alarm (Red)	On	Severe load sharing imbalance. Solar converter output disabled for any reason, including overvoltage shutdown and internal output fuse open. Converter addresses contradictory. ESTOP. User code mismatch. Safety short circuit.
		Flashing	Fan not operating (solar converter shuts down).

2.3 Solar Converter High Voltage Shutdown and Lockout Restart

Procedure

1. Turn the power to the solar converter off or remove the solar converter, wait 30 seconds or more (until the LEDs on the solar converter extinguish), then turn the power to the solar converter on or re-insert the solar converter.

2.4 Solar Converter Current Limit

When setting total solar converter current limit, the set point to each solar converter is the total set point divided by the number of solar converters. For example, if the system contains five solar converters and the current limit is set to 150 amps, then each solar converter has a current limit set point of 30 amps. If one or more solar converters are removed or fail it will take several seconds for the individual set points to the remaining solar converters to be reset. In the example given, if one solar converter is removed the current limit set point will drop to 120 amps (30 amps times four remaining solar converters) until the controller can send updated set points to the remaining solar converters. This takes a couple communication cycles (several seconds) after which each solar converter would have a new set point of 37.5 amps for a total of 150 amps. The total current limit of the solar converters should not be set such that the loss of the redundant solar converters will cause this temporary set point to drop below the actual maximum expected load. If batteries are used on the solar converter output, the batteries should support the load until the current limit set points can be re-established due to loss of a solar converter.

2.5 Installing Solar Converters

Solar converter modules can be inserted or removed with power applied (hot swappable).



NOTE! Each solar converter module locks into a module mounting shelf by means of a latch located on the bottom of the module. The latch and solar converter module handle are interactive. Pushing the handle up into the module's front panel causes the latch to extend to the locking position; pulling the handle down out from the module's front panel causes the latch to retract. See Figure 2.2.



CAUTION! This solar converter module contains double pole fusing; parts of the equipment that remain energized might represent a hazard during servicing after operation of the fuse. A short circuit inside the module may cause the fuse to blow if the module is damaged. Before installing or replacing a solar converter, you should disconnect the solar array and ensure that the input of the solar converter is disconnected from the solar panel. After the installation is completed, connect the solar panel.



WARNING! To prevent damage to the latching mechanism, ensure the handle is in the open position when installing or removing a solar converter module. NEVER hold the handle in the closed position when installing a solar converter module into a shelf.

Procedure



NOTE! Refer to Figure 2.2 as this procedure is performed.

1. Unpack the module.
2. Place the module into an unoccupied mounting slot without sliding it in completely.
3. Loosen the captive screw on the module's handle. Pull the handle down out from the module's front panel (this will also retract the latch mechanism). See Figure 2.2.
4. Push the module completely into the shelf.
5. Push the handle up into the module's front panel. This will lock the module securely to the shelf. Tighten the captive screw on the handle.
6. Repeat the above steps for each solar converter module being installed in the system.
7. After the solar converter modules are physically installed in the mounting shelf(s), they are ready for operation immediately after power is supplied to them.

8. Certain functions (i.e., solar converter current limit, solar converter addressing) may require adjustment when adding or replacing a solar converter module. Refer to “Solar Converter Current Limit” on page 12 and the Power System documentation for instructions.

Figure 2.2 Installing Solar Converter Module

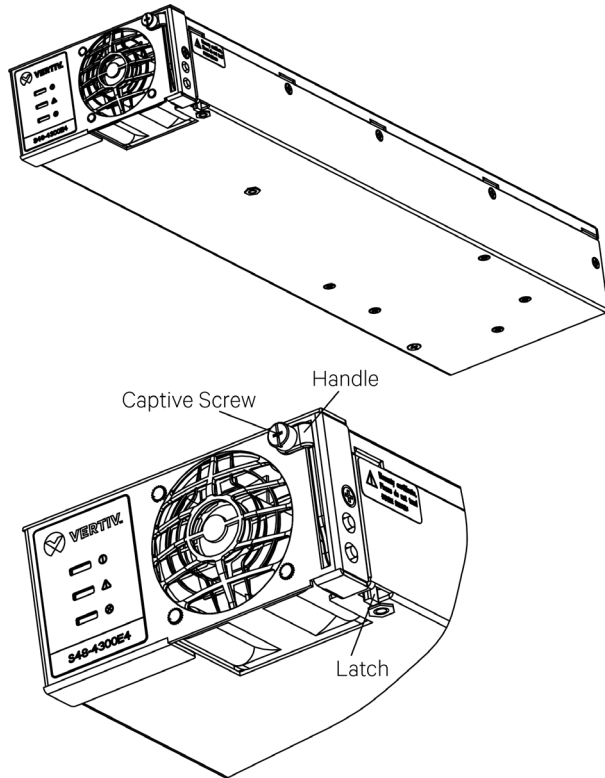

3 Troubleshooting and Repair

3.1 Troubleshooting

3.1.1 Solar Converter Current Sharing Imbalance

When multiple solar converters are operating in parallel and the load is greater than 10%, if the current sharing imbalance among them is greater than 5%, check if the solar converter is properly seated in the shelf.

If the current sharing imbalance still persists following the verification suggested above, replace the solar converter exhibiting the current imbalance.



3.1.2 Solar Converter Fault Symptoms and Troubleshooting

The fault indicators that can be displayed by the solar converter are as follows. Refer to Table 3.1 for a list of possible causes and corrective actions.

- Power Indicator (Green) Off
- Protection Indicator (Yellow) ON
- Protection Indicator (Yellow) Flashing

- Alarm Indicator (Red) ON
- Alarm Indicator (Red) Flashing

Table 3.1 Solar Converter Troubleshooting

Symptom		Possible Cause(s)	Suggested Action(s)
	Power Indicator (Green) Off	No input voltage.	Make sure there is input voltage.
		Internal input fuse open.	Replace the solar converter.
	Protection Indicator (Yellow) On	DC input under/over voltage.	Correct the DC input voltage to within the acceptable range.
		BOOST under/over voltage.	Replace the solar converter.
		Moderate load sharing imbalance.	Check if the solar converter is properly seated in the shelf. If this does not correct the fault, replace the solar converter.
		Converter over-temperature protection.	Fan rotor blocked: remove any object that may be blocking the fan. Ventilation blocked (inlet or outlet): remove any object that may be blocking the inlet or outlet. Ambient temperature too high or solar converter inlet too close to a heat source: lower the ambient temperature or relocate the heat source.
		Boost start failure.	Replace the solar converter.
		Unplug failure.	Check the terminals and re-plug, if the problem cannot be eliminated, replace the solar converter.
		Insulation detection fault.	Please check for insulation resistance problems, if not, replace the solar converter.
		Solar converter not inserted into the slot completely.	Remove and properly insert the solar converter.
	Solar converter in ECO Standby Mode when ECO Mode is active in controller	--	
	Protection Indicator (Yellow) Flashing at 0.5Hz	Loss of communication with controller (the solar converter can provide power).	Check the communication cables. Remove and properly insert the solar converter and controller.
Input AC detection.		AC input is in progress, please confirm the input is DC.	
	Alarm Indicator (Red) On	Severe load sharing imbalance. Solar converter output disabled for any reason, including overvoltage shutdown and internal output fuse open.	Turn DC power to the solar converter off or remove the solar converter, wait 30 seconds or more (until the LEDs on the solar converter extinguish), then turn the DC power to the solar converter on or re-insert the solar converter. If solar converter fails to start, shuts down again, or load sharing imbalance persists; replace the solar converter
		Solar converter addresses contradictory.	Replace the solar converter.
	Alarm Indicator (Red) Flashing	Fan not operating (solar converter shuts down).	Replace the fan.

3.2 Replacement Procedures

3.2.1 Solar Converter Module Replacement

Solar converter modules can be inserted or removed with power applied (hot swappable).

 **NOTE!** Each solar converter module locks into a module mounting shelf by means of a latch located on the bottom of the module. The latch and solar converter module handle are interactive. Pushing the handle up into the module’s front panel causes the latch to extend to the locking position; pulling the handle down out from the module’s front panel causes the latch to retract. See Figure 2.2.



DANGER! Take care when removing a solar converter module that was in operation, as solar converter module surfaces could be very hot.



WARNING! To prevent damage to the latching mechanism, ensure the handle is in the open position when installing or removing a solar converter module. NEVER hold the handle in the closed position when installing a solar converter module into a shelf.

Procedure



NOTE! Refer to Figure 2.2 as this procedure is performed.

1. Performing this procedure may activate external alarms. Do one of the following. If possible, disable these alarms. If these alarms cannot be easily disabled, notify the appropriate personnel to disregard any alarms associated with this system while this procedure is performed.
2. Loosen the captive screw on the module's handle. Pull the handle down out from the module's front panel (this will also retract the latch mechanism). See Figure 2.2.
3. Grasp the handle and pull firmly to remove the module from the shelf.
4. Place the replacement solar converter module into the mounting position without sliding it in completely.
5. Loosen the captive screw on the module's handle. Pull the handle down out from the module's front panel (this will also retract the latch mechanism). See Figure 2.2.
6. Push the module completely into the shelf.
7. Push the handle up into the module's front panel. This will lock the module securely to the shelf. Tighten the captive screw on the handle.
8. Certain functions (i.e., solar converter current limit, solar converter addressing) may require adjustment when adding or replacing a solar converter module. Refer to "Solar Converter Current Limit" on page 12 and the Power System documentation for instructions.
9. After the solar converter modules are physically installed in the mounting shelf(s), they are ready for operation immediately after power is supplied to them. Verify that the solar converters are operating normally.
10. Enable the external alarms or notify appropriate personnel that this procedure is finished.
11. Ensure that there are no local or remote alarms active on the system.

3.2.2 Solar Converter Fan Replacement

Each solar converter uses a fan (P/N: 32010544) for cooling. If fan replacement should become necessary, perform the following procedure.

Refer to Figure 3.1 as this procedure is performed.



WARNING! In a system with NO redundant solar converter, battery must have sufficient reserve to power the load(s) while the solar converter is removed for fan replacement.



NOTE! When performing any step in this procedure that requires removal of existing hardware, retain all hardware for use in subsequent steps.

Procedure

1. Performing this procedure may activate external alarms. Do one of the following. If possible, disable these alarms. If these alarms cannot be easily disabled, notify the appropriate personnel to disregard any alarms associated with this system while this procedure is performed.
2. Remove the solar converter from the shelf. Refer to a previous procedure for step-by-step instructions.
3. Place the solar converter on a static-safe work surface. Connect an approved grounding strap to your wrist for the remainder of this procedure.
4. On this solar converter, remove the front panel by removing the three (3) screws securing the front panel to the chassis.
5. For proper orientation of the new fan, observe the location of the fan wires and the fan rotation and air flow arrows on the old fan.
6. Carefully remove the fan from the solar converter chassis and unplug the fan power cable from the printed circuit card.
7. Plug the power cable of the replacement fan into the connector on the printed circuit card. Carefully slide the replacement fan into the solar converter chassis (ensure the fan wires and fan rotation and air flow arrows match the orientation of the old fan).
8. Note that the fan has four holes in the front corners and that the faceplate has three tabs. Carefully slide the faceplate into position, aligning the fan holes with the faceplate tabs. Secure the faceplate to the solar converter chassis with the three (3) screws previously removed.
9. Replace the solar converter into the shelf. Refer to the previous procedure for step-by-step instructions.
10. When the fan starts, check to ensure that it is providing front-to-back airflow. If air direction is wrong, immediately remove the solar converter from the shelf. Repeat previous steps to check fan orientation and correct as necessary. Reinstall the solar converter and again check for proper airflow.
11. Enable the external alarms or notify appropriate personnel that this procedure is finished.
12. Ensure that there are no local or remote alarms active on the system.

Figure 3.1 Fan Replacement

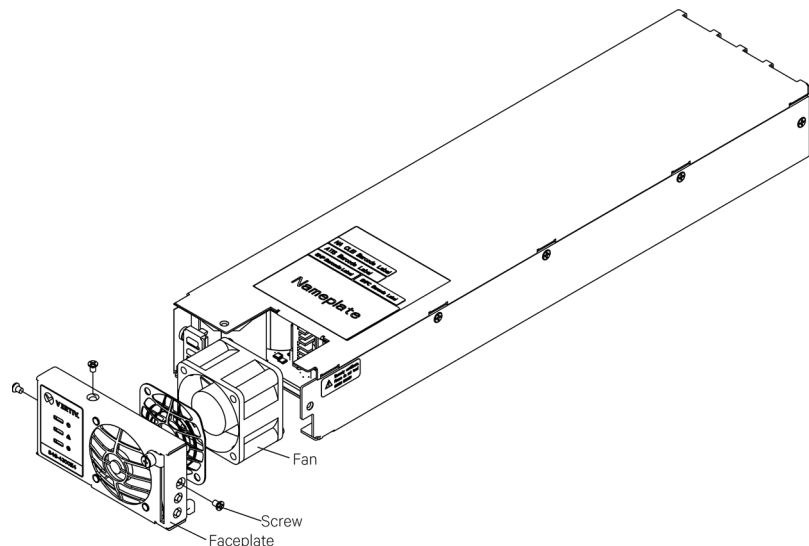

Connect with Vertiv on Social Media



<https://www.facebook.com/vertiv/>



<https://www.instagram.com/vertiv/>



<https://www.linkedin.com/company/vertiv/>



<https://www.twitter.com/vertiv/>



Vertiv.com | Vertiv Headquarters, 505 N Cleveland Ave, Westerville, OH 43082, USA

© 2024 Vertiv Group Corp. All rights reserved. Vertiv™ and the Vertiv logo are trademarks or registered trademarks of Vertiv Group Corp. All other names and logos referred to are trade names, trademarks or registered trademarks of their respective owners. While every precaution has been taken to ensure accuracy and completeness here, Vertiv Group Corp. assumes no responsibility, and disclaims all liability, for damages resulting from use of this information or for any errors or omissions.