

# LIB System for UPS – U6A4

## Installation Manual (136S)

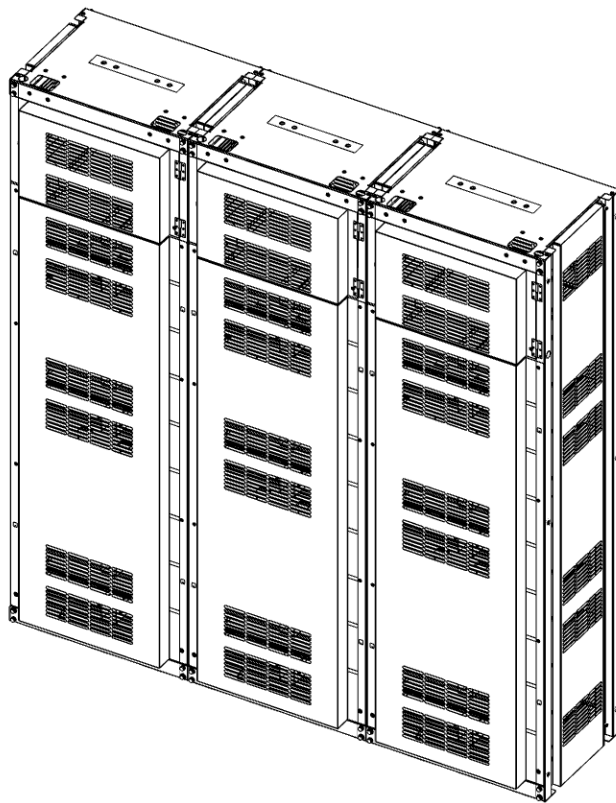

***Read this manual carefully before starting to install the battery system. Keep these instructions for future reference.***

Copyright © 2019 SAMSUNG SDI Co., Ltd. All rights reserved.

This document contains information that is the property of SAMSUNG SDI Co., Ltd., and provides for the sole purpose of the installation, operation, and maintenance of products of SAMSUNG SDI Co., Ltd. No part of this publication is to be used for any other purpose, and it is not to be reproduced, copied, disclosed, transmitted, stored in a retrieval system, or translated into any human or computer language, in any form, by any means, in whole or in part, without prior written consent of SAMSUNG SDI Co., Ltd.





Although every possible effort has been made to ensure the accuracy of this document, SAMSUNG SDI Co., Ltd. assumes no responsibility for errors that may appear herein. The information is subject to change without notice.



# Important Safety Instructions

## Read and follow these instructions!

The following precautions are intended to ensure your safety and prevent property damage. Before installing this product, be sure to read all safety instructions in this document for proper installation.

	<p><b>DANGER</b></p> <p>Failure to comply with the instructions with this symbol may result in a serious accident, causing death or a severe injury.</p>
	<p><b>WARNING</b></p> <p>Failure to comply with the instructions with this symbol may result in a serious accident, causing a severe injury.</p>
	<p><b>CAUTION</b></p> <p>Failure to comply with the instructions with this symbol may result in minor or moderate injury.</p>
	<p><b>NOTICE</b></p> <p>Provides information considered important but not hazard-related. The information relates to property damage.</p>
	<p><b>Important</b></p> <p>Indicates valuable tips for optimal installation and operation of the product.</p>

## General Instructions

Please be aware that a battery presents a risk of electrical shock including high short-circuit current. Follow all safety precautions while operating the batteries.

- Remove watches, rings, and other metallic accessories.
- Use tools with insulated handles in order to avoid inadvertent short circuits.
- Wear rubber gloves and safety boots.
- Do not put tools or any metal parts on the top of the batteries.
- Disconnect charging source and load before connecting or disconnecting terminals.
- Use proper lifting means when moving batteries and wear all appropriate safety clothing and equipment.
- Batteries must be handled, transported and recycled or discarded in accordance with federal, state, and local regulations. Do not dispose of the batteries in a fire because they can explode.
- Do not open or mutilate the batteries.
- Only authorized, trained technicians should perform annual preventive maintenance.
- Only qualified personnel who are familiar with the batteries and safety precautions should perform installation or maintenance of the battery.
- Do not allow unauthorized personnel to contact the batteries.

## Safety Precautions

The following precautions provide general safety guidelines that should be followed when working with or near the Energy Storage System (ESS). Complete safety parameters and procedures are site-specific and should be developed by the customer for the installation site.

- Review and refer to all safety warnings and cautions in this manual before installation.
- Build a clear, permanent, restricted access area around the system.
- Only authorized, adequately trained electrical operators should be able to access the system.

The interior design of this equipment must be considered a “no-go area except for non-qualified personnel who are familiar with the batteries and safety precautions,” depending on the location. Consult local codes and applicable rules and regulations to determine permit requirements. If required, mark enclosures appropriately before beginning work.

## Personnel and Equipment Warnings

Personnel in contact with the battery system should be aware of the following hazards:



### WARNING—SHOCK HAZARD

Do not contact system connectors or terminals. Do not open the enclosure doors unless proper lock out/tag out procedures and related trainings are followed in accordance with the local codes and regulations.



### WARNING—ARC FLASH HAZARD

There is an arc flash hazard associated with all electrical equipment. There is a serious risk of arc flash relating to any equipment modification (e.g. opening doors). Serious injuries can occur in arc flash incidents. Appropriate training is required in accordance with local codes and regulations.



### WARNING—FIRE HAZARD

Fire may occur under certain fault conditions.



### CAUTION—PINCH POINTS

Multiple pinch-points are present in most system components. Be aware that there is a serious risk of injury while working around and in equipment enclosures.



### CAUTION—STATIC SENSITIVE

Electronic appliances can be damaged by electrostatic discharge. Proper handling procedures are required. Be sure to wear a grounded anti-static wrist strap and to discharge static electricity by touching a grounded surface near the equipment before touching any system components.

## Dangerous Voltages



### DANGER

The ESS is powered by multiple power sources. Hazardous voltages may be present in the equipment even when it does not appear operational. Make sure that you completely understand the cautions and warnings in this installation manual. Failure to do so may result in serious injury or death. Follow all manufacturer-published safety procedures.

Electrical equipment can present a risk of electrical shock and can cause arc flash. The following precautions must be observed when working on or around electrical equipment:

- Remove watches, jewelry, rings, and other metallic objects.
- Use tools with insulated handles.
- Safety clothing and shoes must comply with local codes and regulations.

## Lock Out/Tag Out Guidelines



### DANGER

Follow all applicable lock out/tag out procedures at all times. Failure to follow proper lock out/tag out procedures may result in serious injury or death.

With power applied to the ESS, hazardous voltages are present on some components. To prevent accidental death or injury, do not touch any components within the enclosure unless you are specifically directed to do so. To reduce the risk of electrical shock, make sure that all equipment is properly grounded. For more information, refer to 3.1 Grounding the Battery System



### WARNING

Enclosure doors must remain closed except when access to the enclosure interior is required. If possible, personnel should keep a safe distance from enclosures whenever the equipment is energized. Always comply with local, state, and national lock out/tag out guidelines when working with or near the ESS. The lock out/tag out procedures must meet or exceed the requirements of all guidelines presented in SAMSUNG SDI safety documentation. Before entering potentially hazardous areas or beginning work on the ESS, complete the following tasks:

- Identify and wear protective clothing and shoes.
- Identify and isolate all power and stored energy sources.
- Apply appropriate lock out/tag out devices. When applying lock out/tag out to the ESS, do not touch anything within the enclosure except as specifically directed in the work procedures.
- Complete the site-specific lock out/tag out procedures and safety checklist before beginning work.

## General Warnings



### DANGER

When energized, this equipment presents a potential hazard of electric shock, death, and burn. Only authorized personnel who are thoroughly familiar with the equipment and adequately trained should install, operate, or maintain this equipment.



### DANGER

To avoid death, personal injury, or damage to the product, follow all safety procedures as regulated by Environmental Health and Safety (EHS) guidelines.



### DANGER

To minimize the hazards of electrical shock, death, and burns, approved grounding practices and procedures should be strictly followed.



### WARNING

To avoid personal injury and damage to equipment, personnel must adhere to the site protocol concerning working at heights.



---

## Important Safety Instructions

---

**WARNING**

To avoid personal injury or equipment damage caused by equipment malfunction, only adequately trained personnel should modify any programmable machine.

**WARNING**

Always ensure that applicable standards and regulations are followed and only properly certified equipment is used as a critical component of a safety system. Never assume that a safety-critical control loop is functioning correctly.



# Table of Contents

<b>Important Safety Instructions</b> .....	<b>i</b>
General Instructions.....	ii
Safety Precautions .....	ii
Personnel and Equipment Warnings.....	iii
Dangerous Voltages .....	iii
Lock Out/Tag Out Guidelines .....	iv
General Warnings .....	iv
<b>Table of Contents</b> .....	<b>i</b>
<b>Tables</b> .....	<b>iii</b>
<b>Figures</b> .....	<b>iv</b>
<b>1. About this Manual</b> .....	<b>1</b>
1.1 Purpose .....	1
1.2 Target Audience .....	1
1.3 Organization .....	1
1.4 Revision History.....	2
1.5 Acronyms and Abbreviations .....	3
<b>2. Product Description</b> .....	<b>4</b>
2.1 Major Components .....	4
2.1.1 Battery Module (Type A / Type B).....	5
2.1.2 SMU (String Management Unit) .....	7
2.1.3 SMPS Assembly (Type A / Type B) .....	8
2.1.4 Rack Frame .....	9
<b>3. Installing the Product</b> .....	<b>10</b>
3.1 Grounding the Battery System .....	10
3.2 Arc Flash Calculations.....	11
3.3 Installation Procedure .....	12
3.4 Preparation Stage—Procedure.....	14
3.5 Preparation Stage—Unpacking .....	15
3.6 Preparation Stage—Ground Wire and Tools .....	16
3.6.1 Ground Wires .....	16
3.6.2 Ground Wire Fasteners.....	16
3.6.3 Rack Fasteners (Anchors) .....	16
3.6.4 Multiple Rack Fasteners .....	16
3.7 Preparation Stage—Recommended Tools/Instruments .....	17
3.8 Preparation Stage—Visual Inspection .....	19
3.8.1 Inspection of the Rack Frame .....	19
3.8.2 Inspection of the Modules .....	19
3.8.3 Inspecting the SMU .....	19
3.8.4 Inspecting the SMPS assembly .....	20
3.9 Rack Anchoring Stage.....	21
3.10 Rack Installation Stage .....	30
3.10.1 Front Door Removal.....	31

---

3.10.2	SMU and SMPS Assembly Installation.....	33
3.10.3	Battery Module Installation .....	37
3.10.4	Fuse-Busbar Assembly.....	40
3.10.5	Busbar Installation .....	43
3.10.6	Module and SMU Signal Cable Connection .....	79
3.10.7	SMPS Assembly and SMU Power Cable Connection .....	91
3.10.8	SMPS Assembly and SMU Signal Cable Connection .....	92
3.10.9	SMPS Assembly AC Input Connection .....	94
3.10.10	DC Link Cable Connection .....	100
3.10.11	AC Input Commissioning .....	103
3.10.12	BMS Configuration .....	104
3.10.13	Communication Check.....	104
3.10.14	Reinstall the Front Door .....	105
3.10.15	Reinstall the Front Panel.....	106
3.10.16	Switching on the MCCB .....	107

## Tables

Table 3-1: Estimated time for installation (based on 136S 3P installation) .....	13
Table 3-2: Parts for 136S 3P Rack .....	15
Table 3-3: Ground Wire Specifications .....	16
Table 3-4: Ground Wire Fastener Specification .....	16
Table 3-5: Rack Fastener Specifications .....	16
Table 3-6: Rack Fastener Specifications (Side by side).....	16
Table 3-7: Recommended Tools and Instruments .....	17
Table 3-8: Module Voltage and Internal Impedance .....	19
Table 3-9: Rack Clearance Distances.....	21

# Figures

Figure 2-1: Battery Module Type A .....	5
Figure 2-2: Battery Module Type B .....	6
Figure 2-3: SMU .....	7
Figure 2-4: SMPS Assembly Type A .....	8
Figure 2-5: SMPS Assembly Type B .....	8
Figure 2-6: Rack Frame .....	9
Figure 3-1: Installation Procedure .....	12
Figure 3-2: Clearance Distance for Single Rack Frame .....	22
Figure 3-3: Clearance Distance for Multiple Rack Frames Installed Side-by-Side .....	22
Figure 3-4: Clearance Distance for Multiple Rack Frames Installed Side-by-Side and Rear-to-Rear .....	23
Figure 3-5: Front panel screws (eight) .....	23
Figure 3-6: Front panel hooks (four) .....	24
Figure 3-7: Side panel screws (six) .....	24
Figure 3-8: Side panel hooks (four) .....	25
Figure 3-9: Rear panel screws (eight) .....	25
Figure 3-10: Rear panel hooks (four) .....	26
Figure 3-11: Rack Anchoring Points (4 EA) .....	26
Figure 3-12: Holes on the sides of the rack (six) .....	27
Figure 3-13: Reattaching the Side Panels (four hooks and six screws for each panel) .....	28
Figure 3-14: Reattaching the Rear Panels .....	29
Figure 3-15: Front door ajar .....	31
Figure 3-16: Removing the earth cable .....	31
Figure 3-17: Removing the front door .....	32
Figure 3-18: All doors and front panels removed .....	32
Figure 3-19: Inserting SMU .....	33
Figure 3-20: Attaching a SMU to a Rack Frame .....	33
Figure 3-21: Ground Cable Connection to the SMU .....	34
Figure 3-22: Inserting SMPS Assembly .....	35
Figure 3-23: Attaching the SMPS Assembly .....	35
Figure 3-24: Ground Cable Connection to the SMPS Assembly .....	36
Figure 3-25: Insertion of Modules on the Ninth Shelf from the Bottom .....	37
Figure 3-26: Battery Module Arrangement on the Eighth Shelf .....	38
Figure 3-27: Battery Module Arrangement .....	38
Figure 3-28 : Module Number .....	39
Figure 3-29: Insertion of modules on 1st shelf .....	39
Figure 3-30: Rack Fuse Busbar Assembly .....	40
Figure 3-31: Rack Fuse Busbar Assembly (Fuse Cover) .....	40
Figure 3-32: Fuse Busbar Left Assembly .....	41
Figure 3-33: Fuse Busbar Left Assembly (Fuse Cover) .....	41
Figure 3-34: Fuse Busbar Right Assembly .....	42
Figure 3-35: Fuse Busbar Right Assembly (Fuse Cover) .....	42
Figure 3-36: Copper Busbar Appearance .....	44
Figure 3-37: Conductive Grease on Busbar .....	44
Figure 3-38: Contact Resistance Probe Points (Battery Module Terminal to Busbar) .....	45
Figure 3-39: Removing the Module #1's Cover and SMU B- Terminal Cover .....	46
Figure 3-40: Connect SMU B- and Module #1 B- .....	46
Figure 3-41: Restore SMU's B- Terminal .....	47
Figure 3-42: Remove Battery Module #2's Front Cover .....	47
Figure 3-43: Connect Battery Module #1 B+ and Battery Module #2 B- .....	48
Figure 3-44: Reattach Battery Module #1's Front Cover .....	48
Figure 3-45: Remove Battery Module #2's Front Cover .....	49
Figure 3-46: Connect Battery Module #2 B+ and Battery Module #3 B- .....	49
Figure 3-47: Reattach Battery Module #2's Front Cover .....	50
Figure 3-48: Remove Battery Module #4's Front Cover .....	50

Table of Contents

Figure 3-49: Connect Battery Module #3 B+ and Module #4 B- .....51

Figure 3-50: Reattach Battery Module #3's Front Cover .....52

Figure 3-51: Remove Battery Module #5's Front Cover.....52

Figure 3-52: Connect Battery Module #4 B+ and Battery Module #5 B-.....53

Figure 3-53: Reattach Battery Module #4's Front Cover .....54

Figure 3-54: Remove Battery Module #6's Front Cover.....54

Figure 3-55: Connect Battery Module #5 B+ and Battery Module #6 B-.....55

Figure 3-56: Reattach Battery Module #5's Front Cover .....56

Figure 3-57: Remove Battery Module #7's Front Cover.....56

Figure 3-58: Connect Battery Module #6 B+ and Battery Module #7 B-.....57

Figure 3-59: Reattach Battery Module #6's Front Cover .....58

Figure 3-60: Remove Battery Module #8's Front Cover.....58

Figure 3-61: Connect Battery Module #7 B+ and Battery Module #8 B-.....59

Figure 3-62: Reattach Battery Modules #7's Front Cover.....59

Figure 3-63: Remove Battery Modules #9's Front Cover .....60

Figure 3-64: Connect Battery Module #8 B+ and Battery Module #9 B-.....61

Figure 3-65: Reattach Battery Modules #8's Front Cover .....61

Figure 3-66: Remove Battery Modules #10's Front Cover .....62

Figure 3-67 Connect Battery Module #9 B+ and Battery Module #10 B-.....62

Figure 3-68: Reattach Battery Module #9's Front Cover .....63

Figure 3-69: Remove Battery Module #11's Front Cover.....63

Figure 3-70: Connect Battery Module #10 B+ and Battery Module #11 B-.....64

Figure 3-71: Reattach Battery Module #10's Front Cover .....65

Figure 3-72: Remove Battery Module #12's Front Cover.....65

Figure 3-73: Connect Battery Module #11 B+ and Battery Module #12 B-.....66

Figure 3-74: Reattach Module #11's Front Cover .....67

Figure 3-75: Remove Module #13's Front Cover .....67

Figure 3-76: Connect Battery Module #12B+ and Battery Module #13 B- .....68

Figure 3-77: Reattach Module #12's Front Cover .....69

Figure 3-78: Remove Battery Module #14's Front Cover.....69

Figure 3-79: Connect Battery Module #13 B+ and Battery Module #14 B-.....70

Figure 3-80: Reattach Battery Module #13's Front Cover .....71

Figure 3-81: Remove Battery Module #15's Front Cover.....71

Figure 3-82: Connect Battery Module #14 B+ and Battery Module #15 B-.....72

Figure 3-83: Reattach Battery Module #14's Front Cover .....73

Figure 3-84: Remove Battery Module #16's Front Cover.....73

Figure 3-85: Connect Battery Module #15 B+ and Battery Module #16 B-.....74

Figure 3-86: Reattach Battery Module #15's Front Cover .....75

Figure 3-87: Remove Battery Module #17's Front Cover.....75

Figure 3-88: Connect Battery Module #16 B+ and Battery Module #17 B-.....76

Figure 3-89: Reattach Battery Module #15's Front Cover .....77

Figure 3-90: Remove SMU B+ Terminal Cover.....77

Figure 3-91: Connect SMU B+ and Module #17 B+.....78

Figure 3-92: Reattach Battery Module #17's Front Cover and SMU B+ Terminal Cover .....78

Figure 3-93: SMU to Module #1 Signal Cable .....79

Figure 3-94: Module #1 to Module #2 Signal Cabling.....80

Figure 3-95: Module #2 to Module #3 Signal Cabling.....80

Figure 3-96: Module #3 to Module #4 Signal Cabling.....81

Figure 3-97: Module #4 to Module #5 Signal Cabling.....81

Figure 3-98: Module #5 to Module #6 Signal Cabling.....82

Figure 3-99: Module #6 to Module #7 Signal Cabling.....82

Figure 3-100: Module #7 to Module #8 Signal Cabling.....83

Figure 3-101: Module #8 to Module #9 Signal Cabling.....83

Figure 3-102: Module #9 to Module #10 Signal Cabling.....84

Figure 3-103: Module #10 to Module #11 Signal Cabling.....84

Figure 3-104: Module #11 to Module #12 Signal Cabling.....85

Figure 3-105: Module #12 to Module #13 Signal Cabling.....85

Figure 3-106: Module #13 to Module #14 Signal Cabling.....86

Figure 3-107: Module #14 to Module #15 Signal Cabling .....86

Figure 3-108: Module #15 to Module #16 Signal Cabling .....87

Figure 3-109: Module #16 to Module #17 Signal Cabling .....87

Figure 3-110: Pre-Punched Hole for Signal Cable .....88

Figure 3-111: Signal Cabling Examples of Left Alignment of SMU .....89

Figure 3-112: Termination Resistor Setting for Last SMU .....90

Figure 3-113: DC Power Cables from SMPS Assembly 3 Phase Type A to SMU .....91

Figure 3-114: DC Power Cables from SMPS Assembly 3 Phase Type B to SMU .....91

Figure 3-115: CAN Signal Cable Connection from SMPS Assembly 3 Phase Type A to SMU .....92

Figure 3-116: TCP/IP Cable Connection to SMPS Assembly .....92

Figure 3-117: Dry Contact Cable Connection to SMPS Assembly .....93

Figure 3-118: MCCB Extra Auxiliary Connection .....93

Figure 3-119: AC Input Terminals of SMPS Assembly 3 Phase Type A .....94

Figure 3-120: AC Input Terminals of SMPS Assembly 3 Phase Type B .....94

Figure 3-121: AC Input Terminals of SMPS Assembly 1 Phase Type A .....95

Figure 3-122: AC Input Terminals of SMPS Assembly 1 Phase Type B .....95

Figure 3-123: SMPS Assembly 3 Phase Type A - AC Input Terminals with Cables Attached .....96

Figure 3-124: SMPS Assembly 3 Phase Type B - AC Input Terminals with Cables Attached .....96

Figure 3-125: SMPS Assembly 1 Phase Type A - AC Input Terminals with Cables Attached .....97

Figure 3-126: SMPS Assembly 1 Phase Type B - AC Input Terminals with Cables Attached .....97

Figure 3-127: AC Input Terminals of SMPS Assembly 3 Phase Type A .....97

Figure 3-128: AC Input Terminals of SMPS Assembly 3 Phase Type B .....98

Figure 3-129: AC Input Terminals of SMPS Assembly 1 Phase Type A .....98

Figure 3-130: AC Input Terminals of SMPS Assembly 1 Phase Type B .....99

Figure 3-131: Grounding Points (2 EA).....100

Figure 3-132: Connecting the DC Link High Current Terminals.....101

Figure 3-133: Reattaching the Front Door .....105

Figure 3-134: Reattaching the earth cable.....105

Figure 3-135: Front panel hooks (four) .....106

Figure 3-136: Front panel screws (eight) .....106

Figure 3-137: MCCB Handle in Trip Position .....107

Figure 3-138: MCCB Handle in Off Position .....107

Figure 3-139: MCCB Handle in On Position.....107







# 1. About this Manual

To make sure that you understand the proper procedures for safe operation, this section briefly describes the purpose, audience, organization, revision history, and acronyms and abbreviations.

## 1.1 Purpose

The purpose of this manual is to provide information for the safe and successful installation of the product

The instructions in this manual are based on assembly of a three-cabinet system. Other configurations are possible and the instructions can be reduced or expanded to accommodate installation of those systems.

## 1.2 Target Audience

This installation manual is intended for system administrators and operators who install and configure the product.

## 1.3 Organization

This manual is composed of the following chapters:

- Chapter 1, “About this Manual,” outlines this document.
- Chapter 2, “Product Description,” describes the major components of the product.
- Chapter 3, “Installing the Product,” explains how to install the product.

## 1.4 Revision History

Rev.	Description	Author	Date
0.0	First Draft		2019.08.20
0.1	Revised module voltage check level. SMU Auxiliary switch and SMPS Status auxiliary contact electrical ratings added (Table 2 1, Table 2 11)		2019.09.05
0.2	Updated Table 3-7: Recommended Tools and Instruments Revised Table 3-2: Parts for 136S 3P Rack Revised 3.10.5 Busbar Installation Revised 3.10.12.3 System BMS Configuration		2019.12.27
0.21	Revised 3.10.5 Busbar Installation		2020.01.08
0.3	Product model number updated (Product Description, Table 3-2: Parts for 136S 3P Rack) Revised Table 3-7: Recommended Tools and Instruments		2020.08.12
0.31	Version for end customer Removed confidential watermark		2020.08.12

Approved By:		
Name	Signature	Date

Reviewers		
Name	Signature	Date

## 1.5 Acronyms and Abbreviations

The following acronyms and abbreviations are used in this manual.

Abbreviations	Full Name
AED	Automated External Defibrillator
BMS	Battery Management System
EHS	Environmental Health and Safety
ESS	Energy Storage System
LOTO	LOCK OUT/TAG OUT
OT	Overtemperature
OVP	Overvoltage Protection
PCS	Power Conversion System
SMU	String Management Unit
SMPS	Switched Mode Power Supply
SOC	State Of Charge
SOH	State Of Health
SG	Switchgear
UT	Undertemperature
UVP	Undervoltage Protection
UPS	Uninterruptible Power Supply

## 2. Product Description

Check the components for installation. For more information, please refer to the product specification.

### 2.1 Major Components

This product has the following components:

- Battery Module (Type A / Type B)
- SMU
- Rack BMS (Embedded in SMU)
- Rack Frame
- SMPS Assembly (Type A / Type B)
- System BMS (Embedded in SMPS Assembly Type A)

Refer to the “Product Specification” document for detailed specifications of the components.

### 2.1.1 Battery Module (Type A / Type B)

Battery Module is the most basic component of the Battery System and it contains the energy storing battery cells. There is a Module BMS inside each Battery Module. Module BMS checks the status of a Battery Module by measuring its voltage and temperature. It also communicates with the SMU to send all measured voltage and temperature data, and to receive commands to control cell balancing.

There are two types of 8S1P Battery Module depending on the position of terminal's polarity. Type A's plus(+) terminal is on the right side. Type B is on the left.

Type A: EM2031AE003A

Type B: EM2031AE004A

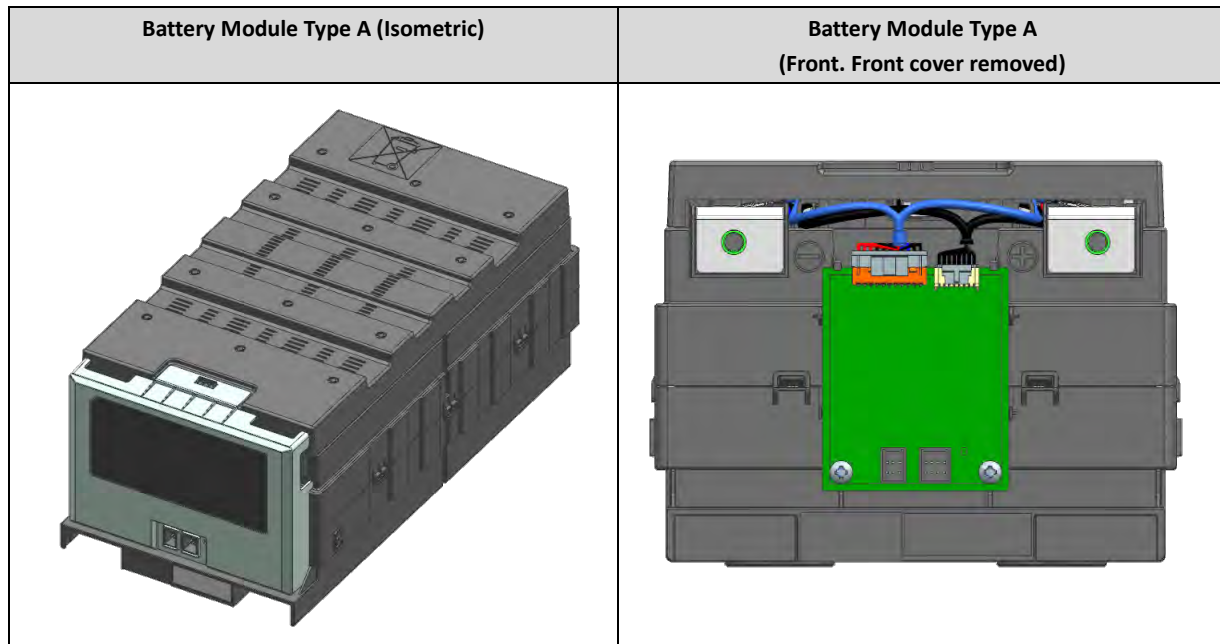

Figure 2-1: Battery Module Type A

## 2. Product Description

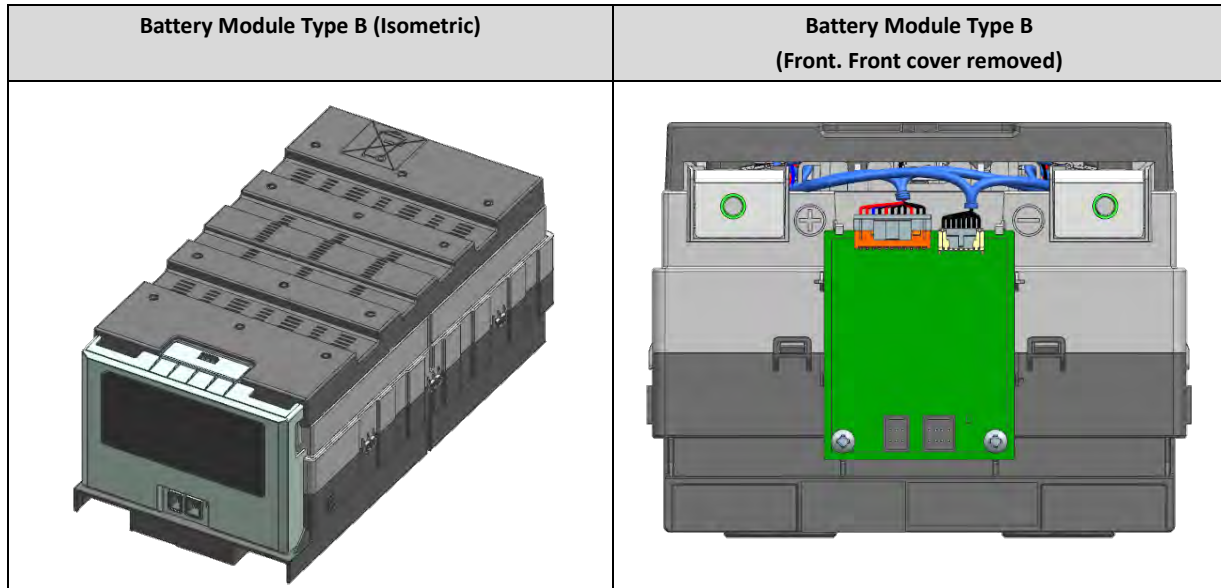

Figure 2-2: Battery Module Type B



### 2.1.2 SMU (String Management Unit)

SMU collects all information about the battery system and controls the battery system by switching the main power line and controls each Battery Module by cell balancing. SMU calculates the state-of-charge (SOC) and state-of-health (SOH) of the battery system. Key components in the SMU are Rack BMS, MCCB, and shunt resistor. Rack BMS is the main controller that takes all data from the Module BMS, measures the string voltage and current, determines the state of the battery and controls the MCCB accordingly.

UL: V049-0011AA

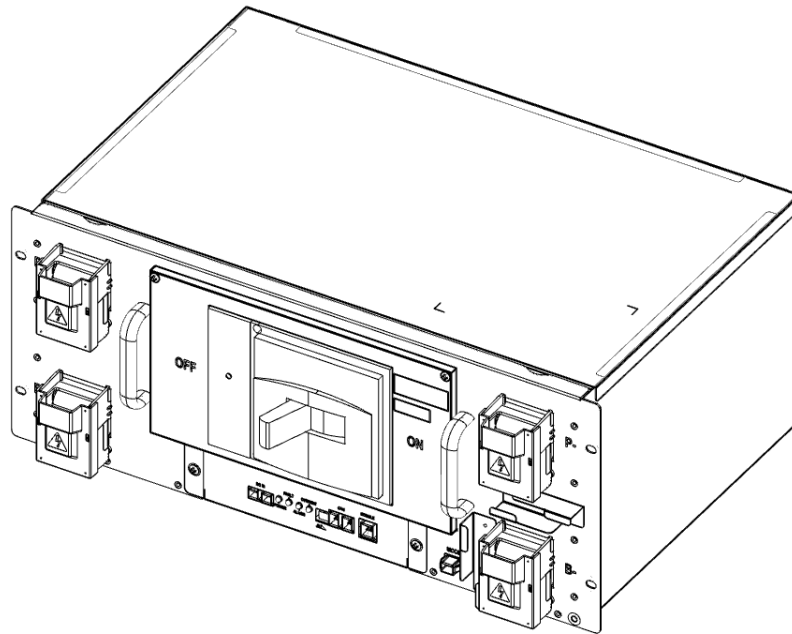

Figure 2-3: SMU

2. Product Description

**2.1.3 SMPS Assembly (Type A / Type B)**

- 3-Phase Type A (with System BMS): V044-0006AA
- 3-Phase Type B (without System BMS): SJ94-00238B
- 1-Phase Type A (with System BMS): V044-0004AA
- 1-Phase Type B (without System BMS): V044-0005AA

SMPS Assembly houses the System BMS and SMPS, which provides power to the System BMS and SMU. Two options are available for the SMPS depending on the AC input range and cabling: 3 phase and 1 phase. The System BMS assembly provides data to the external systems (i.e. building management system, UPS, etc.) while controlling and monitoring all connected Rack BMS.

There are two types of SMPS Assembly: Type A is with System BMS and Type B is without System BMS.

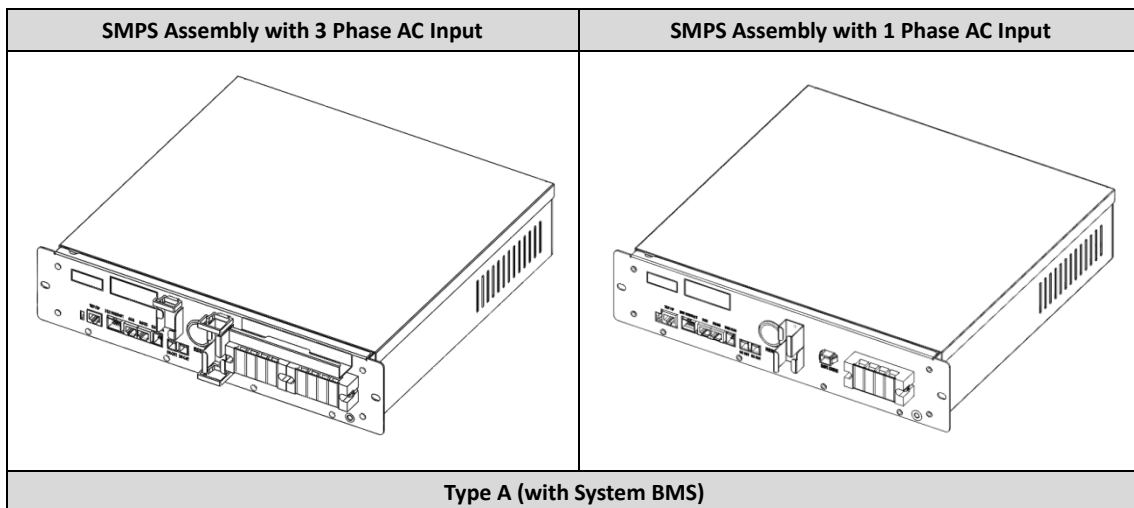

Figure 2-4: SMPS Assembly Type A

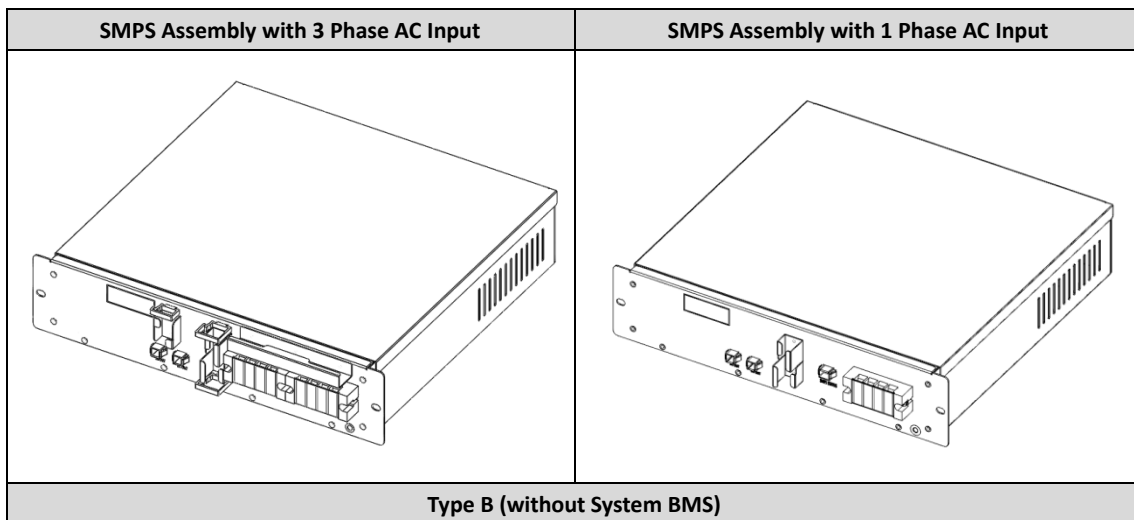

Figure 2-5: SMPS Assembly Type B

### 2.1.4 Rack Frame

Black: V808-00068A

The Rack Frame is used to mount the modules, SMU and SMPS assembly and provides ground connections for SMU and SMPS Assembly.

(Grounding cable/busbar for the rack frame is necessary for the SMU and SMPS Assembly as they are grounded to the rack frame when installed. An equipment grounding conductor is required to ground the rack frames together and to the UPS module).

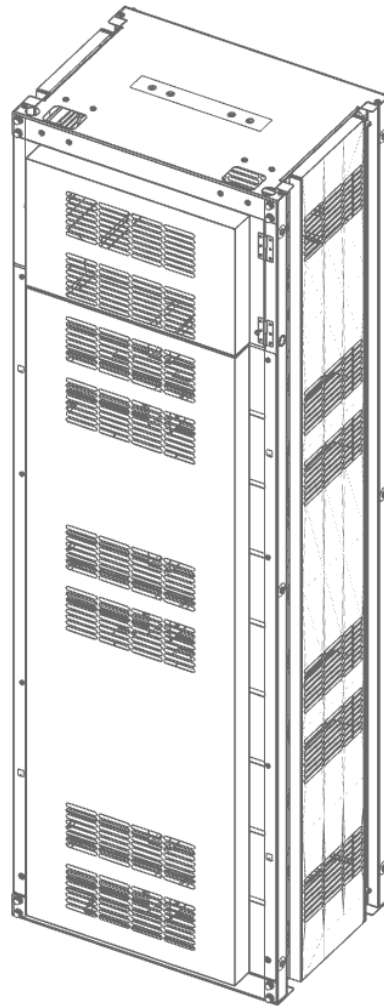



Figure 2-6: Rack Frame

## 3. Installing the Product

Because this product has a battery with more than 300V present when fully assembled, installer must follow the general safety instructions. This system must be installed by qualified, trained workers familiar with the required instruments. Use appropriate lifting methods when moving the batteries.

	<b>WARNING</b>
	<ul style="list-style-type: none"> <li>▪ The power terminal cap must be left in place on the power terminal of the tray for insulation.</li> <li>▪ Be sure to use insulated tools (torque wrench, extension, socket, etc.).</li> <li>▪ All the instruments must be insulated and no metal articles (e.g. watch, ring) should be present in the installation area.</li> <li>▪ All power switches must be turned off in advance.</li> <li>▪ Prepare a CO<sub>2</sub> fire extinguisher, a first aid kit, and an AED (automated external defibrillator) before installation.</li> </ul>

	<b>CAUTION</b>
	<ul style="list-style-type: none"> <li>▪ If available, use a mechanical lift for lifting heavy (22 kg [50 lb.]) components. If there is no lift, two or three workers must move items weighing more than 22 kg (50 lb.).</li> <li>▪ The ambient temperature range must be 23°C ±5°C during installation.</li> </ul>

### 3.1 Grounding the Battery System



**WARNING—SHOCK HAZARD**

Verify with a voltmeter that no power is present on the system before beginning work on the battery system or other part of the UPS system. Use lock out/tag out procedures to secure the UPS and batteries. Do not contact system connectors or terminals. Follow all applicable safety measures.

Follow all local and national codes and regulations.

Grounding methods and wiring must comply with NEC Article 250.

Grounding is required to prevent electric shock hazards and reduce or eliminate damage caused by electrical noise. Ground connections and ground wire routing vary significantly depending on system configuration and equipment layout. Samsung provides grounding strip on top of each rack. See Figure 3-131: Grounding Points (2 EA).

## 3.2 Arc Flash Calculations

Arc flash related calculation of the battery system is estimated with the Direct-Current Incident Energy Calculations referenced in Informative Annex D of NFPA 70E Standard for Electrical Safety in the Workplace.

The following battery system is assumed to estimate the worst-case scenario

Battery configuration: 136S

Battery voltage: 571.2V

Battery internal resistance (AC IR): 65mohm

Arc flash related calculation based on this battery system is as follows:

Bolted fault current ( $I_{bf}$ ): 9000A

1/2 Bolted fault current ( $1/2 I_{bf}$ ): 4500A

Protective device clearing time ( $T_{arc}$ ): 6ms

Protective device current interrupt capability ( $i^2t$ ): 110000A<sup>2</sup>s

Estimated DC arc flash incident energy at the maximum power point ( $IE_m$ ): 0.072cal/cm<sup>2</sup>

### 3.3 Installation Procedure

This product must be installed by following the procedure below:

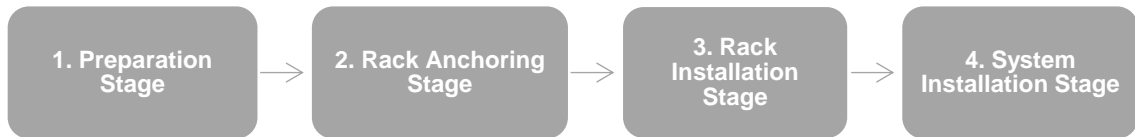

Figure 3-1: Installation Procedure

- **Preparation Stage**
  - Procedure
  - Unpacking
  - Ground Wire and Tools
  - Recommended Tools/Instruments
  - Appearance Inspection
- **Rack Anchoring Stage**
  - Transport the rack frame to the installation location after unpacking
  - Arrange the rack frame after checking the positions of holes in the frame and anchoring points
  - Perform the anchoring and ground connections
- **Rack Installation Stage**
  - Transport the battery modules to the installation location
  - Insert the SMU in the rack frame
  - Insert the SMPS Assembly in the rack frame
  - After all components are inserted in the rack frame, attach them to the rack frame
  - Place the battery modules in the rack frame
  - Connect the busbars
  - Connect the signal cables from SMU to module, and module to module
  - Connect the signal cables from SMU to SMU
- **System Installation Stage**
  - Connect the SMPS Assembly to AC power source
  - Prepare the items for BMS configuration
  - Configure the BMS
  - Perform installation checks

Estimated time for each step is listed below.

Table 3-1: Estimated time for installation (based on 136S 3P installation)

No.	Step		Estimated Time (HH:MM)	Aggregated Time (HH:MM)
1	Unpacking		00:30	00:30
2	Inspection		01:00	01:30
3	Rack Anchoring		04:00	05:30
4	Rack Installation	Battery Module	00:20	05:50
		SMU	00:10	06:00
		SMPS Assembly	00:10	06:10
		Rack Fuse Assembly	00:30	06:40
		Busbar	01:00	07:40
		Signal Cables	00:20	08:00
		Power and Control Cables	00:20	08:20
		AC Input Installation	00:20	08:40
		Cable Installation	00:10	08:50
		BMS Configuration	00:10	09:00

### 3. Installing the Product

---

## 3.4 Preparation Stage—Procedure

For the preparation stage, perform the following steps:

1. Create the installation plan and check the equipment and instruments for installation.
2. Check the arrival schedule of the parts required.
3. Unpack the equipment.
4. Inspect the equipment.

	<b>WARNING</b>
	<ul style="list-style-type: none"><li>▪ Do not wear watches, rings, jewelry, or any other metal objects.</li><li>▪ Wear electrically insulated gloves and safety shoes.</li></ul>

	<b>CAUTION</b>
	<ul style="list-style-type: none"><li>▪ Store the product in a dust-free place with the moisture level of below 60% and the temperature level of 23°C ±5°C.</li><li>▪ Keep components out of direct sunlight.</li></ul>



### 3.5 Preparation Stage—Unpacking

Check the following parts during unpacking:

Table 3-2: Parts for 136S 3P Rack

No.	Items	Part No.	Amount (Unit: EA)	Remarks
1	RACK FRAME	V808-00068A	3	Black
2	BATTERY MODULE Type A	EM2031AE003A	24	
3	BATTERY MODULE Type B	EM2031AE004A	27	
4	SMU	V049-0011AA	3	
5	SMPS ASSEMBLY Type A (WITH SYSTEM BMS ASSEMBLY)	V044-0004AA (1 Phase) V044-0006AA (3 phase)	1	For Rack #1
6	SMPS ASSEMBLY Type B	V044-0005AA (1 phase) SJ94-00238B (3 phase)	2	For Rack #2, 3
7	BUSBAR M TO SMU	V050-00051A	6	Connect modules and SMU
8	BUS-BAR MAIN	SJ66-00863A	39	High current bus bar connection for modules
9	RACK FUSE BUSBAR_R_136S	SJ66-00868A	3	Connect between modules #8 and #9
10	RACK FUSE BUSBAR_L_136S	SJ66-00876A	3	Connect between modules #8 and #9
11	FUSE	3601-001835	9	Connect between modules #5 and #6, between modules #8 and #9, and between modules #14 and #15
12	FUSE COVER #1	SJ63-00101A	3	Fuse cover for fuse between modules #8 and #9
13	FUSE COVER #2	V143-00002A	12	Fuse cover for fuse between modules #5 and #6, and between modules #14 and #15
14	FUSE BUSBAR LEFT UPPER	V050-00002A	3	Connect between modules #14 and #15
15	FUSE BUSBAR LEFT LOWER	V050-00001A	3	Connect between modules #14 and #15
16	FUSE BUSBAR RIGHT UPPER	V050-00003A	3	Connect between modules #5 and #6
17	FUSE BUSBAR RIGHT LOWER	V050-00004A	3	Connect between modules #5 and #6
18	WIRE ASSY RACK TO MODULE	V046-0005BA	3	Connect Battery Module #1 and SMU.
19	WIRE ASSY MODULE TO MODULE #1	SJ39-00673A	45	Signal Connection for Modules
20	WIRE ASSY RACK TO RACK #2	SJ39-00674A	2	Connect Rack between #1, #2 and #3.
21	WIRE ASSY RACK TO SYSTEM	SJ39-00719A	1	Connect the Rack BMS CAN connector in the SMU to the System BMS CAN connector in the SMPS ASSEMBLY.
22	WIRE ASSY RACK TO SMPS	SJ39-00718A	6	Connect the Rack BMS DC IN to SMPS ASSEMBLY DC OUT
23	WIRE ASSY MODULE TO MODULE #2	SJ39-00678A	3	Signal connection between modules #8 and #9
24	WIRE ASSY EARTH	SJ39-00725A	6	Connecting SMPS Assembly and SMU to Rack Frame.
25	SCREW M5 X 10	SJ60-00068A	30	Mounting SMU, SMPS, and WIRE ASSY EARTH to Rack Frame
26	SCREW M8 X 18	V701-00089A	102	Mounting Busbar to Module
27	SCREW M12 X 25	SJ60-00138A	12	Mounting Busbar to Switchgear
28	SCREW M12 X 16	SJ60-00137A	18	Mounting Fuse Busbar to Fuse
29	SCREW M10 X 25	SJ60-00082A	12	Mounting Rack Frame to Rack Frame side by side
30	NUT M10	SJ81-01208A	12	Mounting Rack Frame to Rack Frame side by side
31	M10 FLAT WASHER	SJ60-00073A	12	Mounting Rack Frame to Rack Frame side by side
32	WIRE ASSY MCCB AUX	SJ39-00807A	3	Connect to MCCB Aux Contact
33	WIRE ASSY DRY CONTACT	SJ39-00808A	1	Connect to SMPS Assembly DRY CONTACT

3. Installing the Product

### 3.6 Preparation Stage—Ground Wire and Tools

Ground wires for the racks must be provided by the installer. Installer-supplied ground wires must meet the specifications below.

Refer to 3.1 Grounding the Battery System for details on grounding.

#### 3.6.1 Ground Wires

Use ground wire that is 70 sq mm. The ground wire specifications are:

Table 3-3: Ground Wire Specifications<sup>1</sup>

Wire No.	Terminal Type
70 sq mm or thicker	M12 2 Hole Ring Terminal

#### 3.6.2 Ground Wire Fasteners

Specifications for the ground wire fastening screws are:

Table 3-4: Ground Wire Fastener Specification<sup>2</sup>

Size	Hardness	Thread Pitch	Material
M12–30L	70 (Grade 7)	1.25 mm (0.05 in)	SS304

#### 3.6.3 Rack Fasteners (Anchors)

Specifications for the rack fastener screws for anchoring the rack frame to the floor are:

Table 3-5: Rack Fastener Specifications<sup>3</sup>

Size	Hardness	Thread Pitch	Material
M16–L (Bottom Anchor)	70 (Grade 7)	2.0 mm (0.08 in)	SS304

#### 3.6.4 Multiple Rack Fasteners

Rack fasteners are factory-provided. Refer to Table 3-2: Parts for 136S 3P Rack for part number and quantities.

Specifications for the rack fastener screws for installing multiple rack frames side-by-side are:

Table 3-6: Rack Fastener Specifications (Side by side)

Size	Hardness	Thread Pitch	Material
M10–25L (Side)	70 (Grade 7)	1.5 mm (0.06 in)	SS304

<sup>1</sup> Not provided. Must be provided by the installer or customer.







<sup>2</sup> Not provided. Must be provided by the installer or customer.

<sup>3</sup> Not provided. Must be provided by the installer or customer.

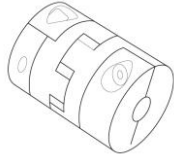

### 3.7 Preparation Stage—Recommended Tools/Instruments

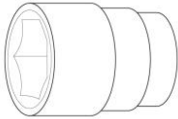
Installers must provide these tools for installing the battery:

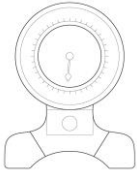
Table 3-7: Recommended Tools and Instruments

No.	Items	Usage	Appearance
1	Power Screwdriver/Drill (Max torque: 26Nm/270 kgf/cm)	To fasten SMU and SMPS assemblies to the rack frames (5.1–6.1Nm/50–60 kgf/cm)	
2	Torque Limiter	For use with torque wrench	
3	Phillips Screwdriver or Bit	To fasten SMU and SMPS assemblies to the rack frames (M5 Tip)	
4	Box Cutter	Opening boxes	
5	Forklift	Moving rack frames and pallets containing modules and SMU	
6	Insulated Torque Wrench	Installing a high-current cable (10~50 N.m / 100 ~ 500 kgf.cm)	
7	Insulated Sockets (13 mm, 17mm and 19mm)	Installing power cables and busbars	
8	Insulated Extension for Socket	Installing a power cable	
9	Inclinometer/Level	Installing a rack frame	

### 3. Installing the Product

No.	Items	Usage	Appearance
10	Battery Tester	<p>Measure battery module's voltage and internal impedance</p> <p>Hioki BT3554, Fluke BT521 or meters with the same or better voltage and resistance measurement resolution and accuracy is recommended.</p> <ul style="list-style-type: none"> <li>- Voltage resolution: 1mV</li> <li>- Voltage accuracy: <math>\pm 0.1\%</math> of reading</li> <li>- Resistance resolution: 0.001m<math>\Omega</math></li> <li>- Resistance accuracy: <math>\pm 1\%</math> of reading</li> </ul> <p>Battery tester may be used to measure the contact resistance between bus bar and the joining terminal if a dedicated resistance meter is unavailable.</p>	
11	Resistance Meter	<p>Measure the contact resistance between bus bar and the joining terminal</p> <p>(Hioki RM3548 or meters with the same or better resistance measurement accuracy is recommended)</p>	

## 3.8 Preparation Stage—Visual Inspection

	<b>CAUTION</b>
	<ul style="list-style-type: none"> <li>▪ If any defects are found during the inspection, contact the SAMSUNG SDI customer service department.</li> </ul>

### 3.8.1 Inspection of the Rack Frame

After transporting the rack frame to the installation location, check for:

- Structural damage
- Paint peeling
- Damaged or protruding screws.

After completion, install or package the rack for protection during storage.

### 3.8.2 Inspection of the Modules

After transporting the modules to the installation location, check for:

- Physical damage to the exterior
- Damaged or protruding screws
- Proper voltage and internal impedance of the battery modules using the battery tester.

Table 3-8: Module Voltage and Internal Impedance

No.	Items	Value
1	Voltage Check	28.080 ~ 29.104V
2	Internal Impedance Check	3.0 ~ 4.3 mΩ

After completion, install the battery module in the previously installed rack or return the battery module to its original packing for protection during storage.

### 3.8.3 Inspecting the SMU

After transporting the SMU to its installation location, check for:

- Physical damage
- Paint peeling
- Damaged or protruding screws.

After completion, install the SMU in the previously installed rack or return the SMU to its original packing for protection during storage.

### 3. Installing the Product

---

#### **3.8.4 Inspecting the SMPS assembly**

After transporting the SMPS Assembly to its installation location, check for:

- Physical damage
- Paint peeling
- Damaged or protruding screws.

After completion, install the SMPS in the previously installed rack or return the SMPS to its original packing for protection during storage.

### 3.9 Rack Anchoring Stage

Install the rack frame on a flat, level surface.

► **To attach the rack and perform the related works**

	<b>CAUTION</b>
	<ul style="list-style-type: none"> <li>▪ Use a proper transportation method considering the weight of the rack frame.</li> <li>▪ Ensure that the safety of the working place is maintained.</li> <li>▪ When using a forklift, lift the rack frame from the front.</li> <li>▪ When a forklift cannot be used, use a mechanical lift or move it by hand with three or more people.</li> <li>▪ Use lock washers to prevent bolts from loosening.</li> <li>▪ Use an inclinometer or carpenter’s level to ensure that the rack frame is plumb.</li> </ul>

	<b>NOTICE</b>
	<ul style="list-style-type: none"> <li>▪ Failure to anchor the rack frame on a flat and level surface may distort the rack frame after installing the racks side-by-side.</li> <li>▪ Frame distortion may make the rack doors difficult or impossible to open.</li> </ul>

	<b>NOTICE</b>
	<ul style="list-style-type: none"> <li>▪ In seismically active areas, the front panel and the rear panel of the rack frame must be installed.</li> </ul>

In order to anchor the racks in all four points, racks are recommended to be placed according to the workable distances listed in the table below. In seismically active areas, all four anchor points of the rack must be installed.

To reduce the product footprint, the racks can be installed side-by-side and rear-to-rear against a wall or next to another rack. In this case, only two anchor points on the front side of each rack can be installed. Proper cooling and ventilation of the installed area is recommended for racks installed with no side and rear clearance. Front side of the rack must be cleared for installation, maintenance, service access, and ventilation and cooling.

Clearance from the top of the rack frame is not required and the top of the rack frame can be covered to prevent any foreign objects from falling into the battery rack frame.

Table 3-9: Rack Clearance Distances

Configuration	Anchor points per rack	Clearance Distance (mm)			
		Side (end)	Side (adjacent)	Rear	Front
Single Rack	2 (Front) not rated for seismic event	0	n/a	0	Workable distance (1000 recommended)
	4 (All) – Telcordia Zone 4	Workable distance (800 recommended)	n/a	Workable distance (800 recommended)	Workable distance (1000 recommended)
Multiple Racks (Side-to-Side)	2 (Front) not rated for seismic event	0	0	0	Workable distance (1000 recommended)
	4 (All) – Telcordia Zone 4	Workable distance (800 recommended)	0	Workable distance (800 recommended)	Workable distance (1000 recommended)

### 3. Installing the Product

Configuration	Anchor points per rack	Clearance Distance (mm)			
		Side (end)	Side (adjacent)	Rear	Front
Multiple Racks (Side-to-Side and Rear-to- Rear)	2 (Front) not rated for seismic event	0	0	0	Workable distance (1000 recommended)
	4 (All) – Telcordia Zone 4	Workable distance (800 recommended)	0	Workable distance (800 recommended)	Workable distance (1000 recommended)

Two anchor points (not rated for seismic event)

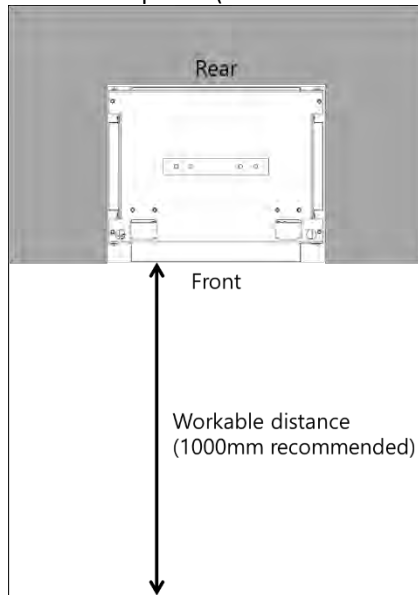

Four anchor points (Telcordia Zone 4)

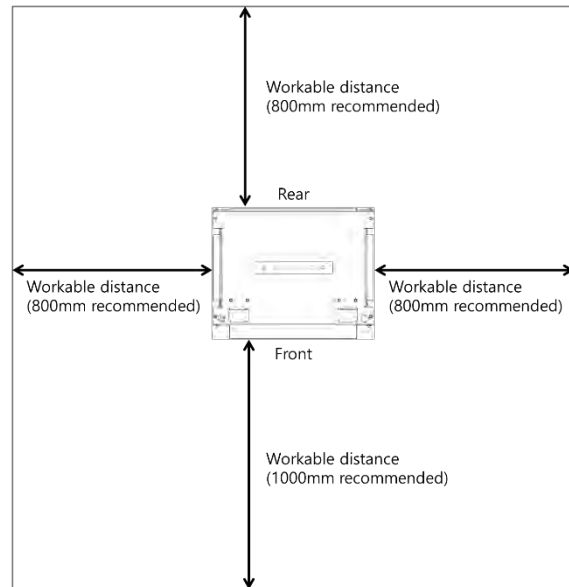
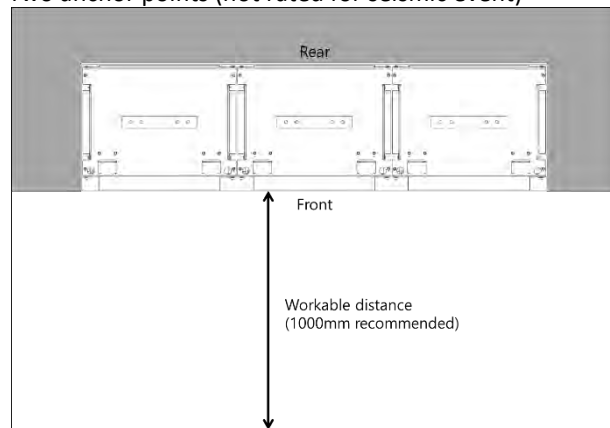

Figure 3-2: Clearance Distance for Single Rack Frame

Two anchor points (not rated for seismic event)



Four anchor points (Telcordia Zone 4)

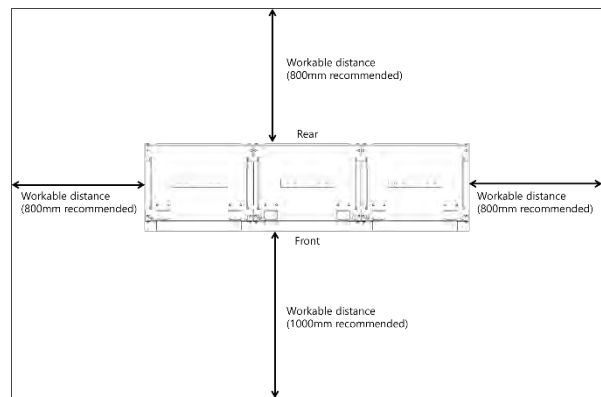
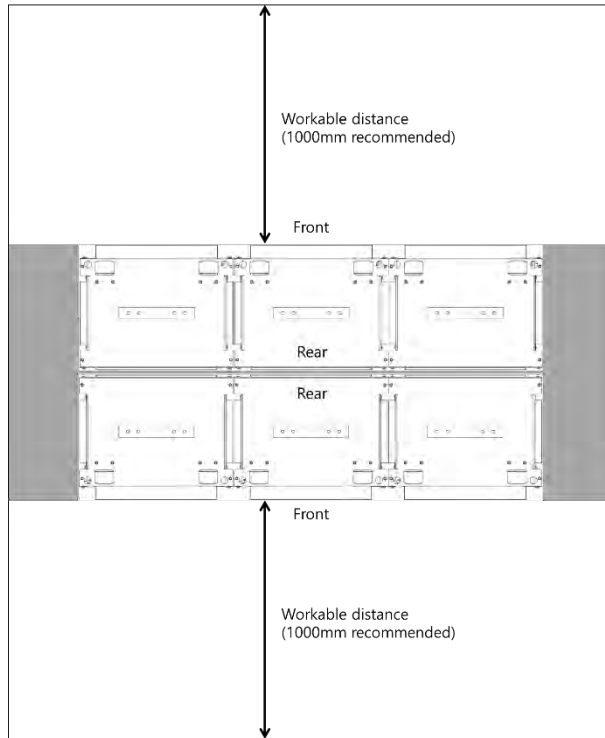

Figure 3-3: Clearance Distance for Multiple Rack Frames Installed Side-by-Side



Two anchor points (not rated for seismic event)



Four anchor points (Telcordia Zone 4)

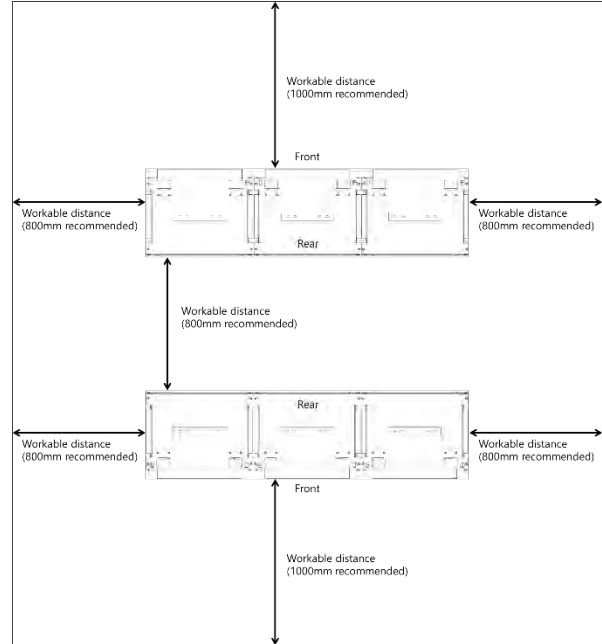

Figure 3-4: Clearance Distance for Multiple Rack Frames Installed Side-by-Side and Rear-to-Rear

1. After unpacking the rack frame, transport it to its installation location.
2. Remove the front panels, side panels and rear panel from the rack frame. Unscrew the screws on each panel and lift the panel to undo the hooks to the frame on each panel. Do not misplace the screws, as they are needed when installing the panels back after anchoring the rack frame.

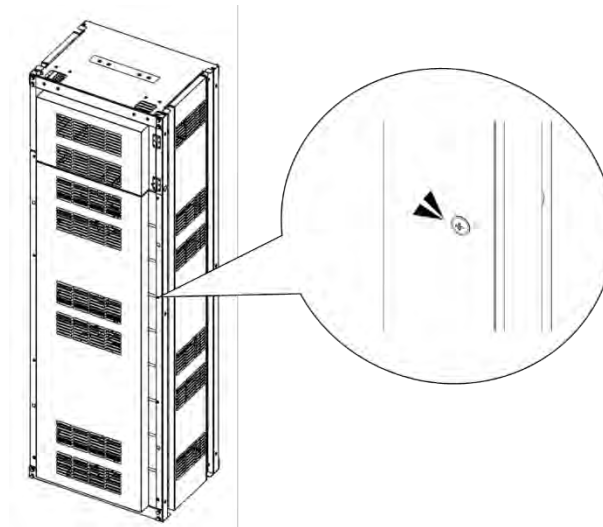

Figure 3-5: Front panel screws (eight)

### 3. Installing the Product

---

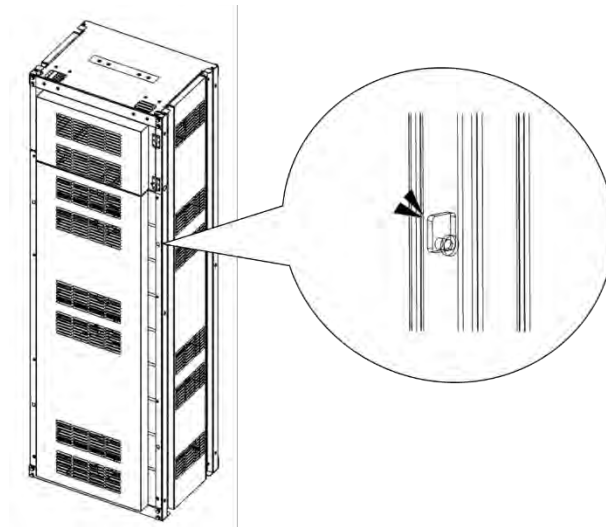

Figure 3-6: Front panel hooks (four)

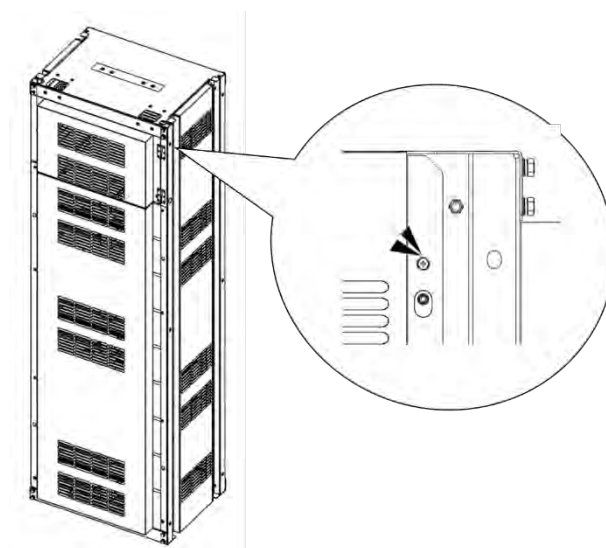

Figure 3-7: Side panel screws (six)

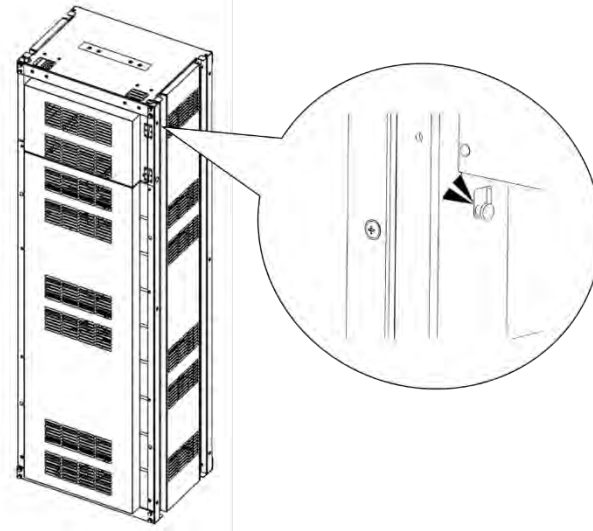

Figure 3-8: Side panel hooks (four)

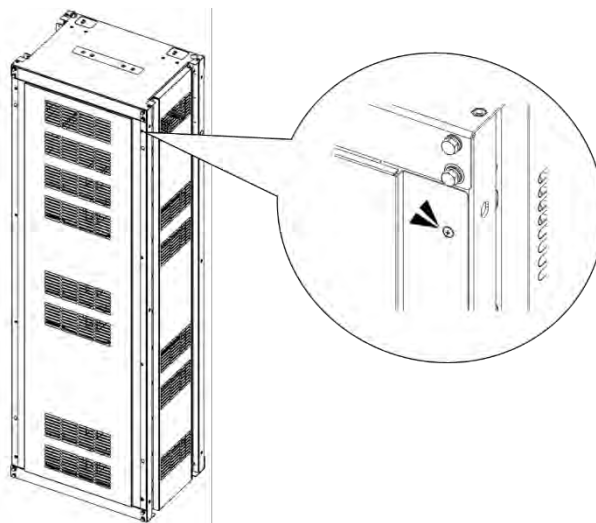

Figure 3-9: Rear panel screws (eight)

### 3. Installing the Product

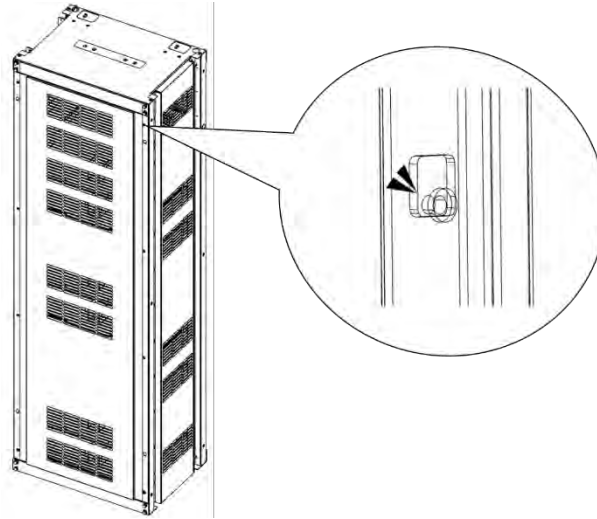

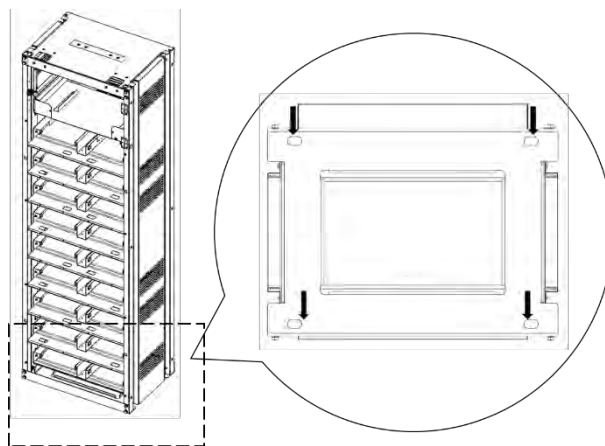

Figure 3-10: Rear panel hooks (four)

3. Arrange the rack frame after verifying that the holes in the frame and anchoring points are aligned.

4. Connect four anchoring points on the bottom of the rack.

	<b>NOTICE</b>
<ul style="list-style-type: none"> <li>▪ Anchor the frame with M16 bolts and nuts.</li> <li>▪ The fastening torque should be 140Nm / 1,425kgf cm.</li> <li>▪ Check the rack and other parts for distortion caused by unpacking.</li> </ul>	



Bottom of the Rack Frame

Figure 3-11: Rack Anchoring Points (4 EA)

5. Connect the racks together using M10 hardware through holes in the sides (“SCREW M10 X 25,” “M10 FLAT WASHER” and “NUT M10”). Torque the bolts to 30Nm (300kgf cm).

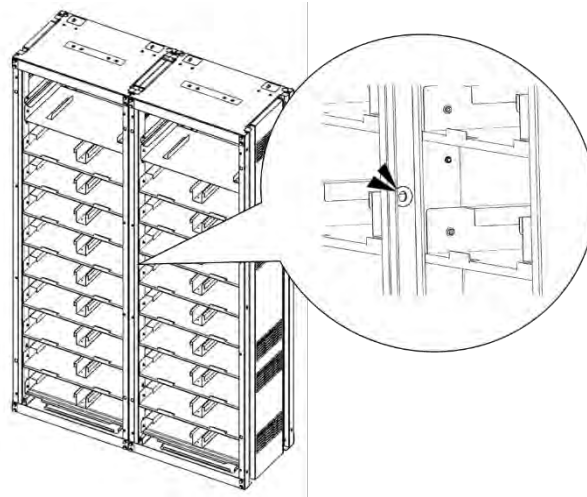

Figure 3-12: Holes on the sides of the rack (six)

6. Optional step: After all the rack frames are anchored and connected, reattach the side panels to the outermost rack frames using the provided M5 Screws for each side panel. Fasten the screws using torque of 5.1–6.1 Nm (50–60 kgf/cm). Make sure all the hooks are inserted to the slot and the panel is flush with the rack frame before screwing.

### 3. Installing the Product

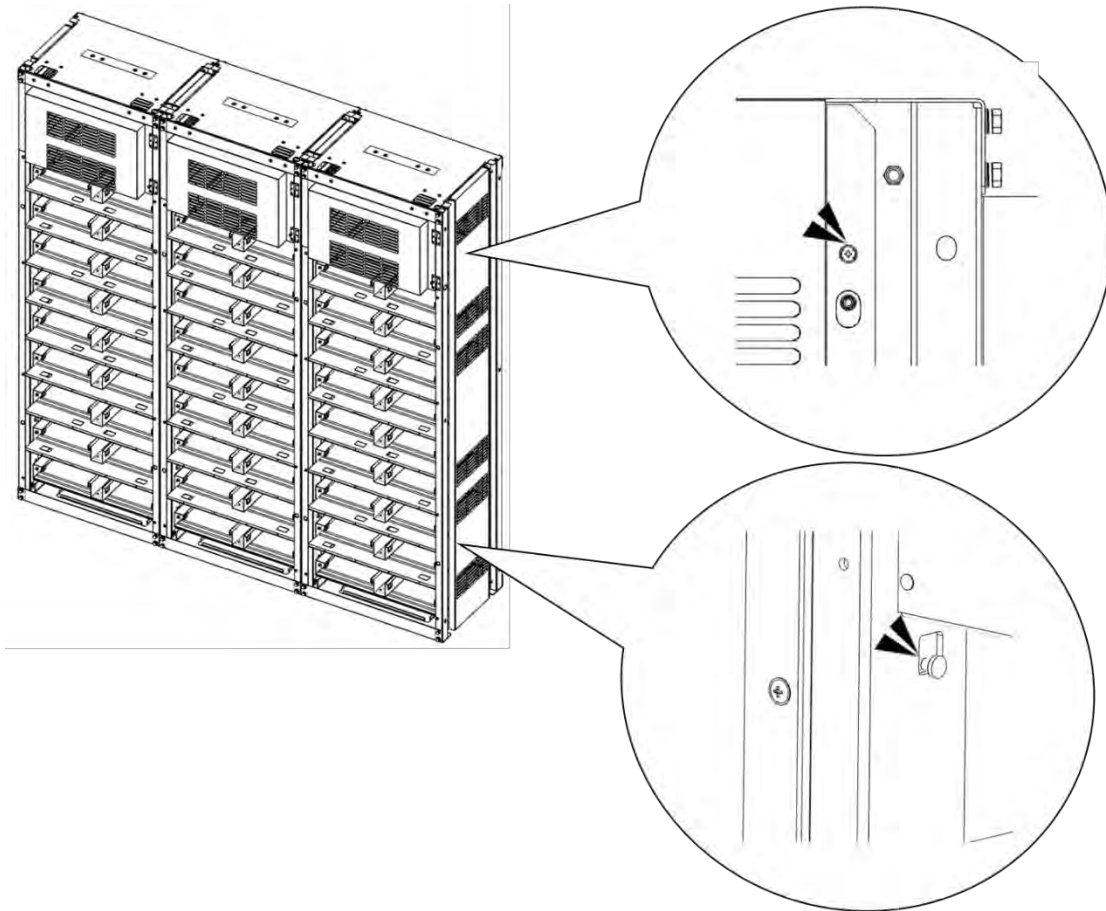

Figure 3-13: Reattaching the Side Panels (four hooks and six screws for each panel)

7. Reattach the rear panels to the rack frames using the provided M5 Screws for each rear panel. Fasten the screws using torque of 5.1–6.1 Nm (50–60 kgf/cm). Make sure all the hooks are inserted to the slot and the panel is flush with the rack frame before screwing.

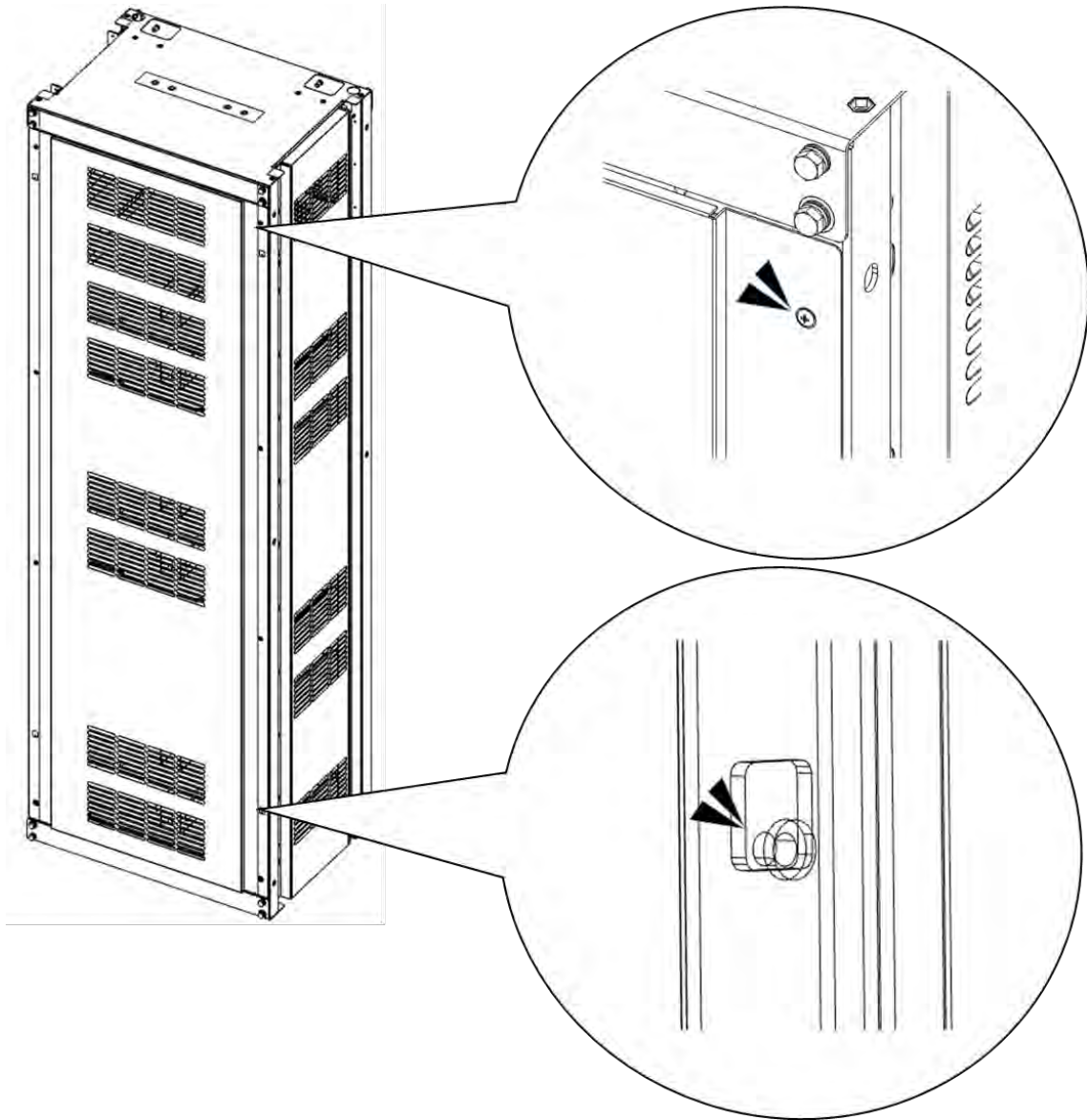





Figure 3-14: Reattaching the Rear Panels

8. Front panels will be reattached after all the components are installed.

### 3.10 Rack Installation Stage

	<p><b>WARNING</b></p> <p><b>Arc Flash and Shock Hazard</b>          Insulated tools are required for any work on this energized equipment.</p>
	<p><b>WARNING</b></p> <p><b>Sharp Edges</b>          Wear gloves and other protective gear to prevent injury.</p>
	<p><b>WARNING</b></p> <p><b>Pinch Point</b>          Use caution when working in the enclosure to prevent injury.</p>
	<p><b>CAUTION</b></p> <p><b>Heavy Object</b>          Can cause muscle strain or back injury.          Use lifting aids and proper lifting techniques when moving trays, batteries and other heavy objects.</p>



### 3.10.1 Front Door Removal

1. Open the front door of the panel using the provided key.

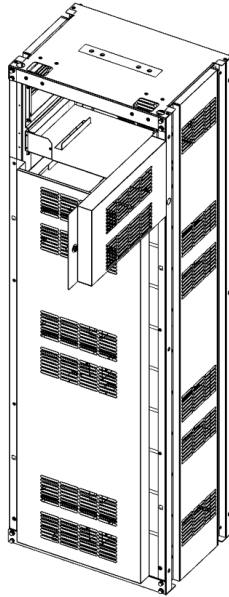

Figure 3-15: Front door ajar

2. Remove the earth cable from the rack frame to the front door. Do not misplace the two screws and the earth cable.

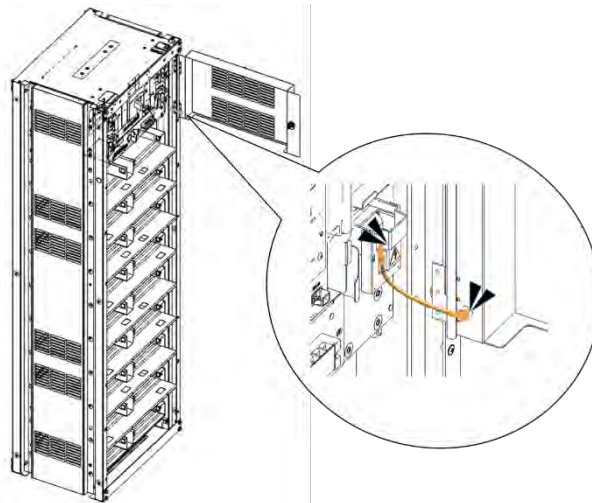

Figure 3-16: Removing the earth cable

3. Lift the front door to remove it from its hinge. Do not misplace the door.

### 3. Installing the Product

---

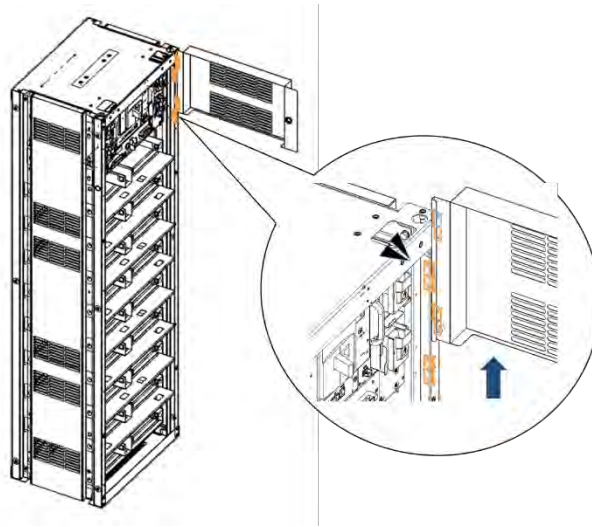

Figure 3-17: Removing the front door

4. If installing more than one rack, remove all the doors.

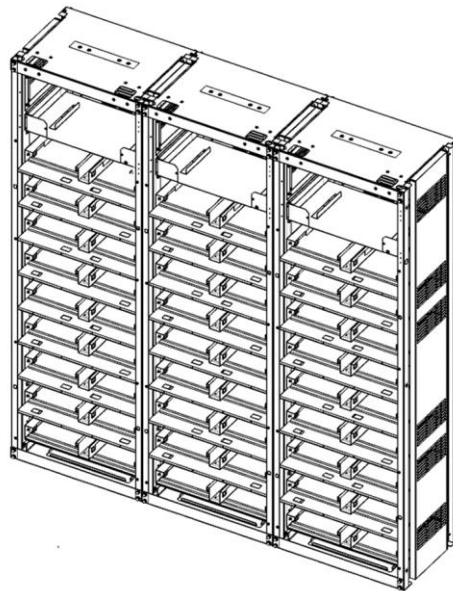



Figure 3-18: All doors and front panels removed.

### 3.10.2 SMU and SMPS Assembly Installation

	<b>Important</b>
	<ul style="list-style-type: none"><li>▪ Attach each SMU to its rack frame with four M5 x 10L screws. (Torque: 5.1–6.1 Nm [50–60 kgf cm])</li><li>▪ Verify that the torque setting is correct.</li></ul>

1. Insert the SMU through the front of the rack as shown in Figure 3-19: Inserting SMU



Figure 3-19: Inserting SMU

2. After all SMU's are inserted in the rack frames, attach each to the rack frame with four M5 x 10L bolts. (Torque: 5.1–6.1 Nm [50–60 kgf cm])

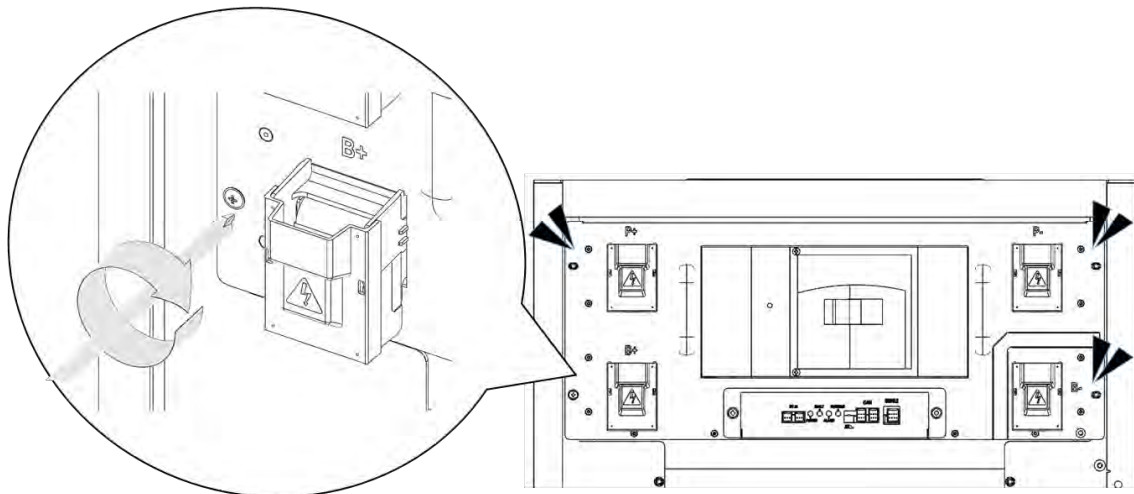

Figure 3-20: Attaching a SMU to a Rack Frame

3. After all SMU's are inserted into the rack frame, connect the ground cable.

### 3. Installing the Product



**NOTICE**

- Connect a ground cable between the SMU and the Rack Frame (SCREW M5 x 10L). (Torque: 5.1–6.1 Nm [50–60 kgf-cm])
- Verify that the torque setting is correct.

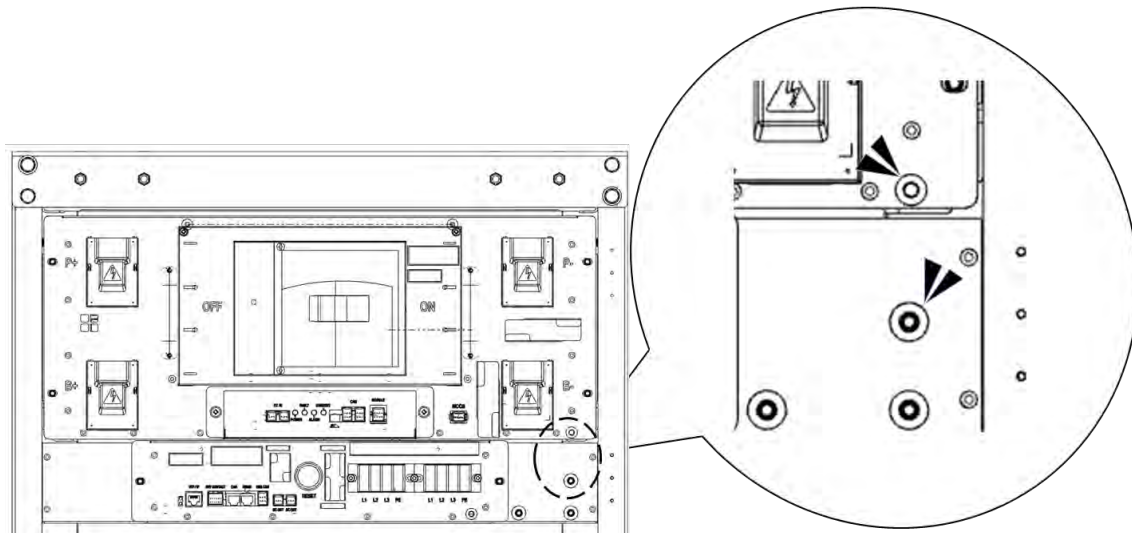



Figure 3-21: Ground Cable Connection to the SMU

4. Insert SMPS Assembly into the rack frames designated for SMPS Assembly as shown in Figure 3-22: Inserting SMPS Assembly

	<p><b>Important</b></p> <ul style="list-style-type: none"><li>▪ Attach the inserted SMPS Assemblies to the rack frames by fastening each with four M5 x 10Lscrews</li><li>▪ (Torque: 5.1–6.1 Nm [50–60 kgf cm])</li><li>▪ Verify that the torque setting is correct.</li></ul>
---	--

5. Slide the SMPS Assembly into the rack frame on the shelf designated for the SMPS Assembly as shown below.

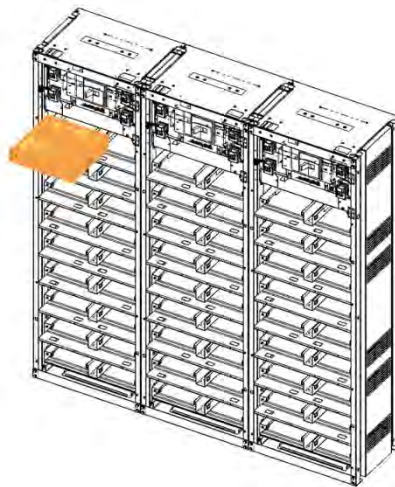

Figure 3-22: Inserting SMPS Assembly

6. After all SMPS Assemblies are inserted into the rack frames, attach them to the rack frame with screws (Torque: 5.1–6.1 Nm [50–60 kgf cm])

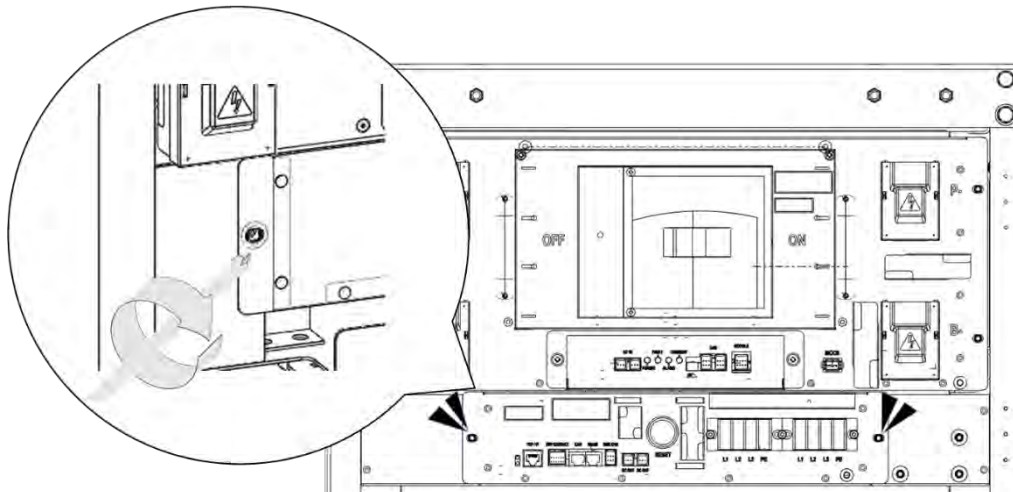



Figure 3-23: Attaching the SMPS Assembly

7. After all SMPS Assemblies are attached to the rack frames, connect the ground cables.

### 3. Installing the Product

	<b>NOTICE</b>
	<ul style="list-style-type: none"><li>▪ Connect a ground cable between the SMPS Assembly and the Rack Frame with an M5 x 10L screw. (Torque: 5.1–6.1 Nm [50–60 kgf cm])</li><li>▪ Verify that the torque setting is correct.</li></ul>

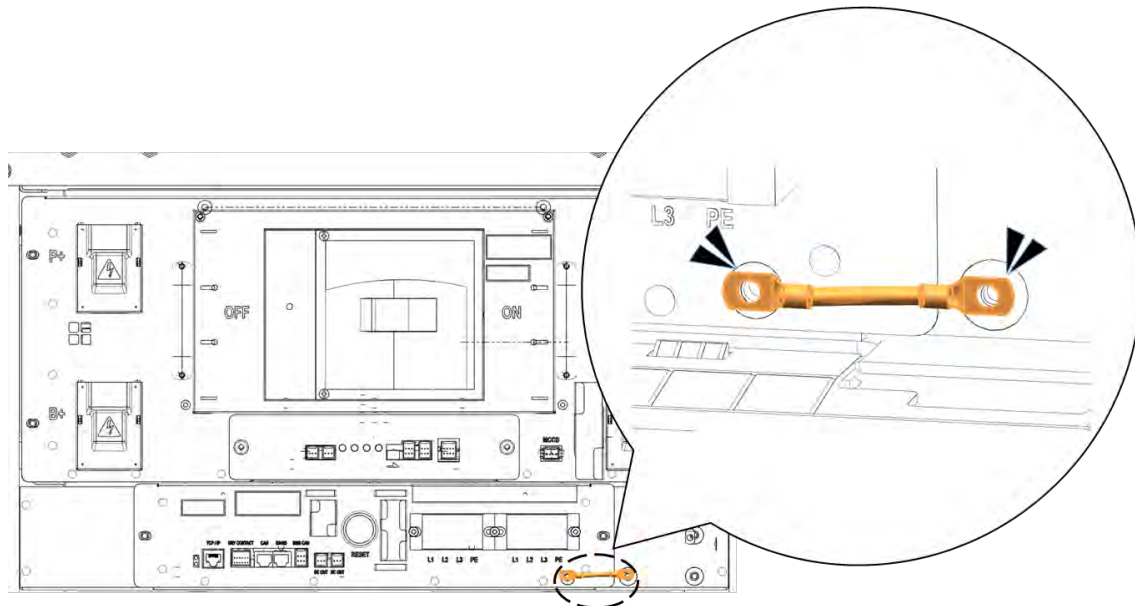



Figure 3-24: Ground Cable Connection to the SMPS Assembly

### 3.10.3 Battery Module Installation

1. Transport battery modules to the installation location.
2. Measure the modules' voltage and internal impedance. All modules in one rack frame must be near the same state of charge. The batteries must have an output within 300mV of each other and internal impedance difference of 1.3m $\Omega$ . Refer to Table 3-8: Module Voltage and Internal Impedance.
3. Place the battery modules on the rack frame.

	Important
	<ul style="list-style-type: none"><li>▪ Samsung recommends installing Battery Modules in the upper shelves first and proceeding to the bottom. (Two Type B battery modules are inserted in the ninth shelf from the bottom.)</li><li>▪ Seventeen battery modules can be inserted into a rack frame as shown in Figure 3-27.</li><li>▪ Refer to 2.1.1 for information on the different battery module types.</li></ul>

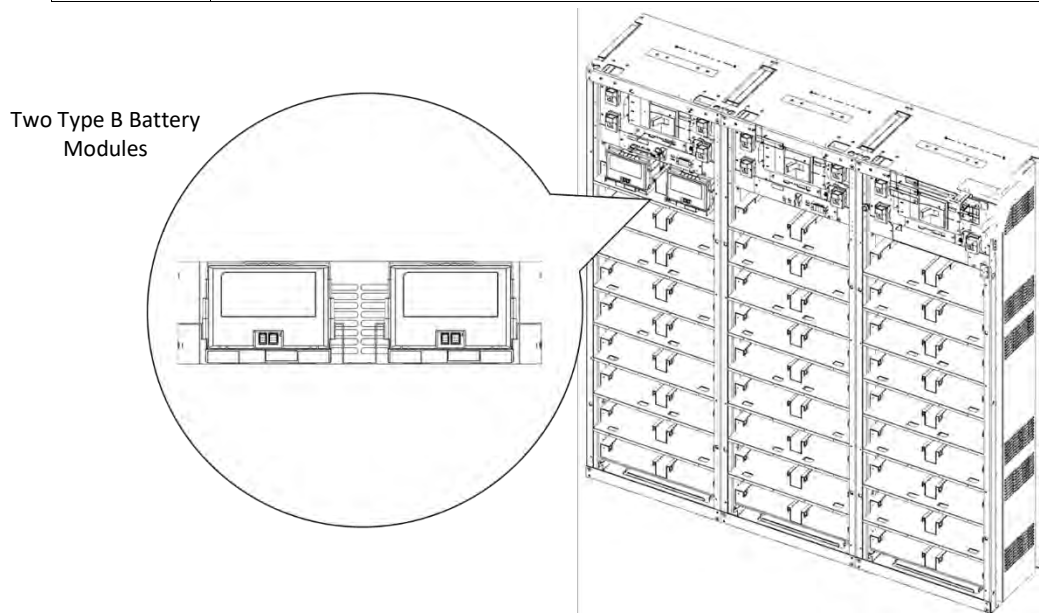

Figure 3-25: Insertion of Modules on the Ninth Shelf from the Bottom

3. Installing the Product

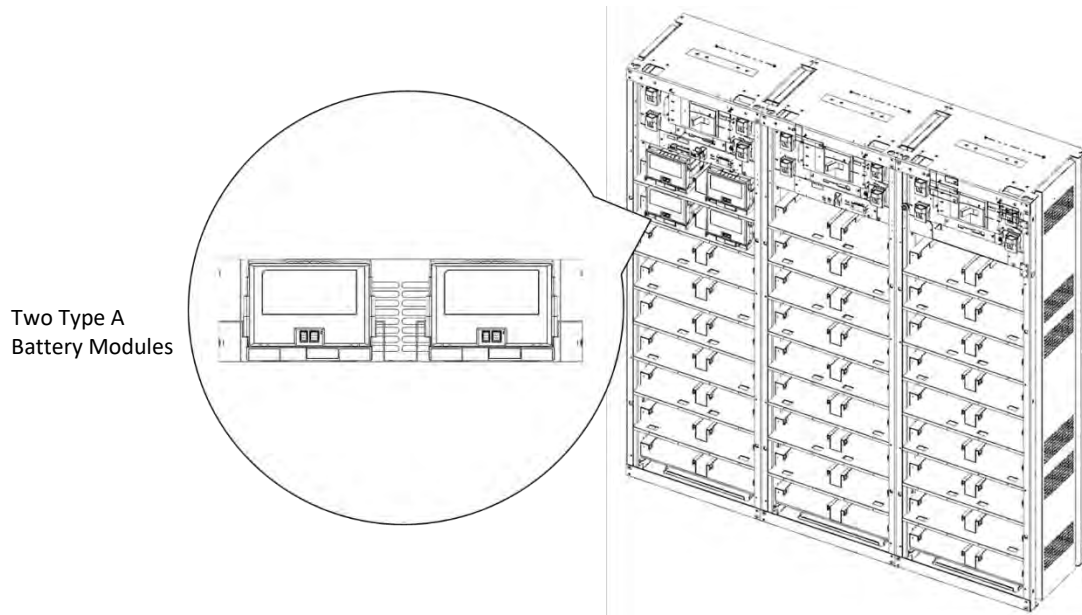

Figure 3-26: Battery Module Arrangement on the Eighth Shelf

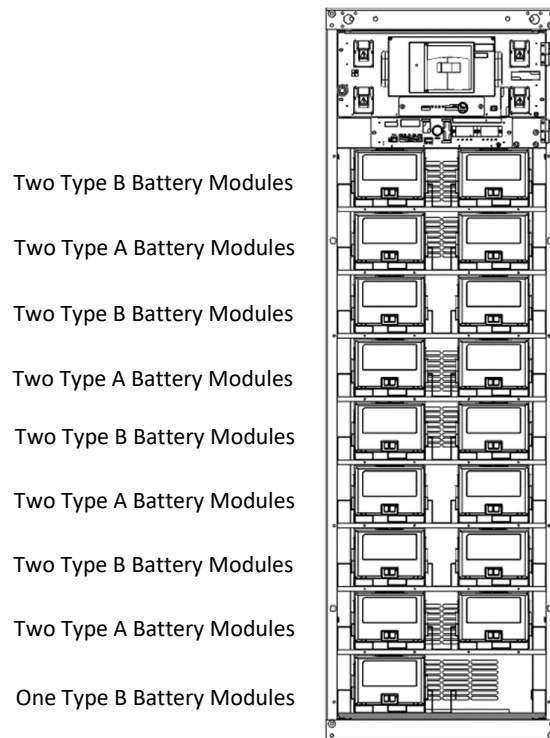

Figure 3-27: Battery Module Arrangement



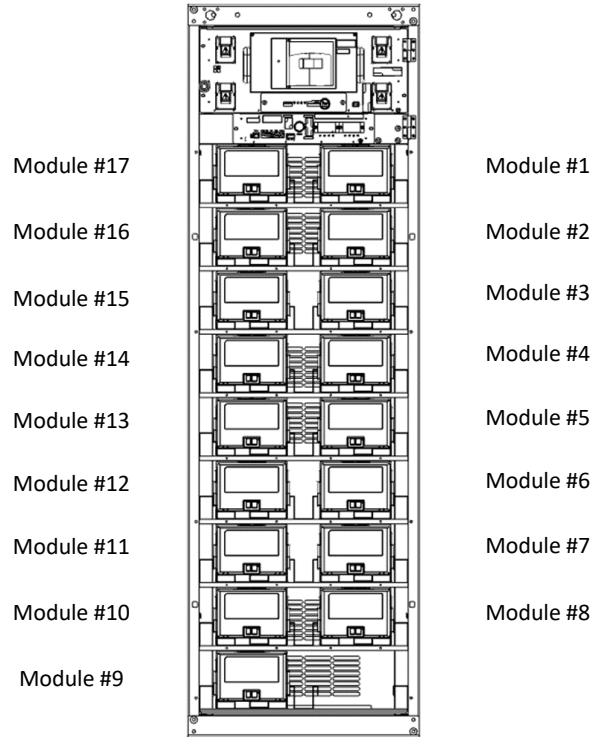



Figure 3-28 : Module Number

	<b>Important</b>
	<ul style="list-style-type: none"> <li>▪ Samsung recommends installing modules from top to bottom.</li> <li>▪ The bottom shelf (1<sup>st</sup> shelf) has one Type B module in the left slot, as shown in Figure 3-29.</li> </ul>

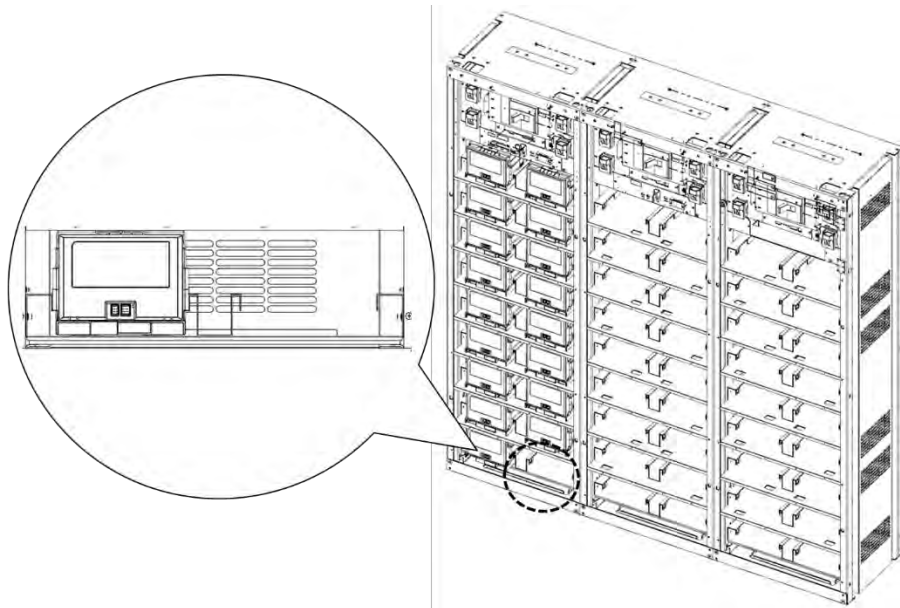



Figure 3-29: Insertion of modules on 1st shelf

### 3. Installing the Product

#### 3.10.4 Fuse-Busbar Assembly

Three types of fuse-busbar assemblies must be assembled before installing them to the Battery Modules.

	<b>NOTICE</b>
	<ul style="list-style-type: none"> <li>Rack Fuse Busbar Assembly is assembled at the installation location.</li> <li>M12 X 16L screws are used to assemble the busbars and fuse.</li> <li>The fastening torque should be 30 Nm (300 kgf/cm).</li> <li>After torqueing, torque mark the screws using a colored marker or a torque seal.</li> <li>When assembling the fuse, make sure the “red indicator arm” on the fuse is facing the front of the unit.</li> </ul>

**1.** Assemble the Rack fuse Bus-bar assembly.

Rack fuse bus-bar assembly is comprised of one “RACKFUSE BUSBAR\_R\_136S”, one “RACKFUSE BUSBAR\_L\_136S”, two “SCREW M12 X 16”, one “FUSE COVER #1”, and one “FUSE”

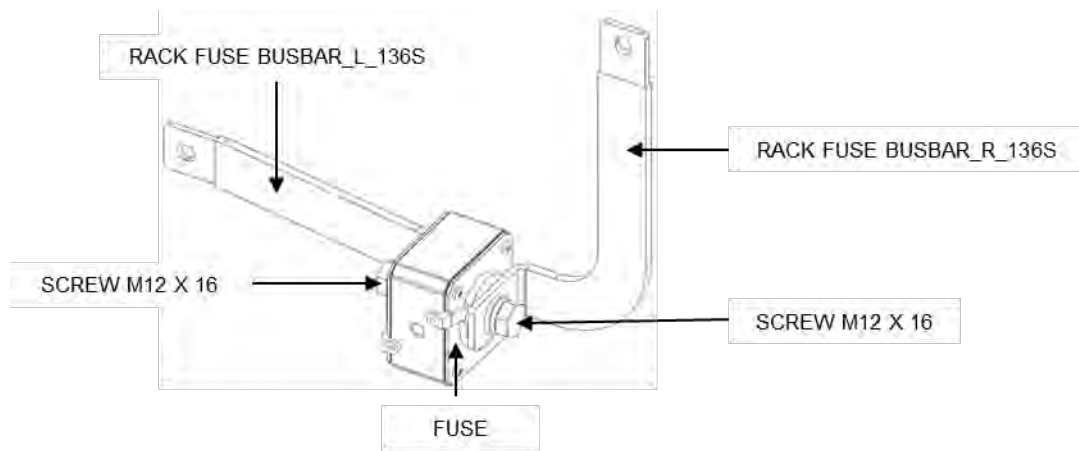

Figure 3-30: Rack Fuse Busbar Assembly

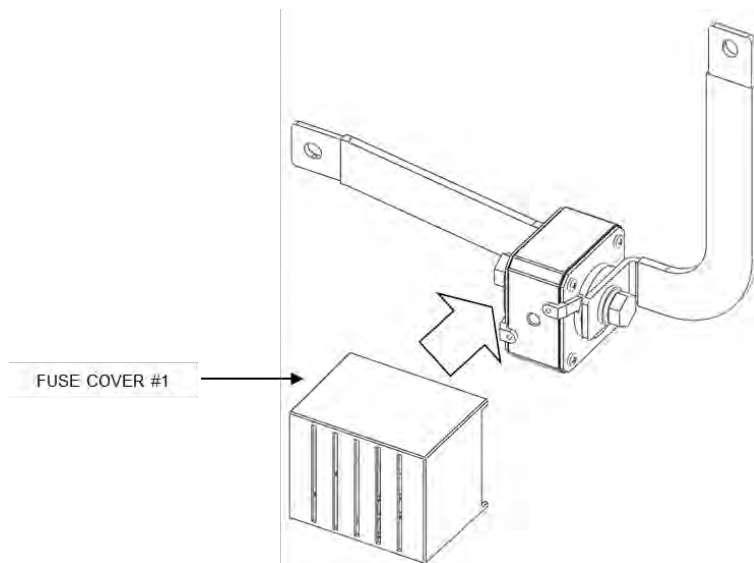

Figure 3-31: Rack Fuse Busbar Assembly (Fuse Cover)

2. Assemble the Fuse Busbar Left Assembly.

Fuse Busbar Left Assembly is comprised of one "FUZE BUSBAR LEFT UPPER", one "FUZE BUSBAR LEFT LOWER", two "SCREW M12 X 16", two "FUZE COVER #2", and one "FUZE"

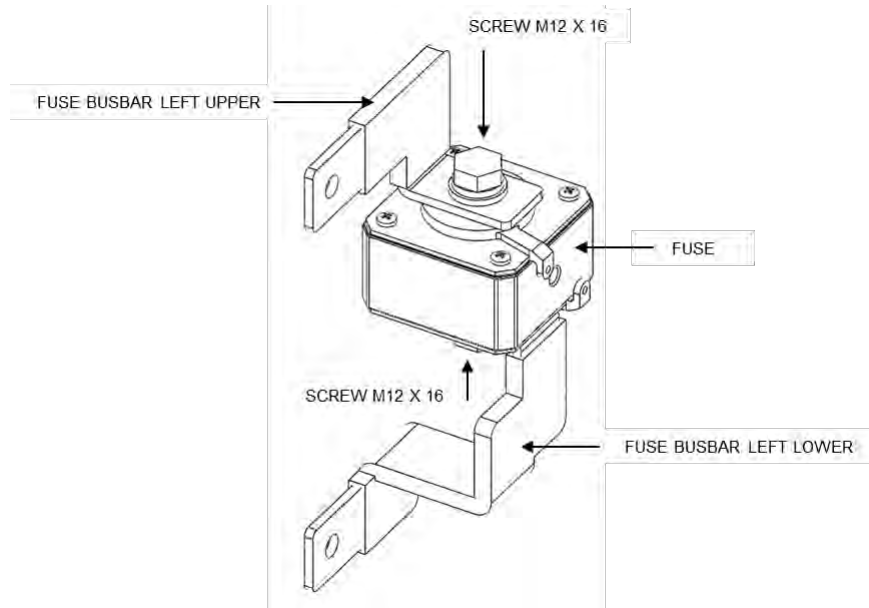

Figure 3-32: Fuse Busbar Left Assembly

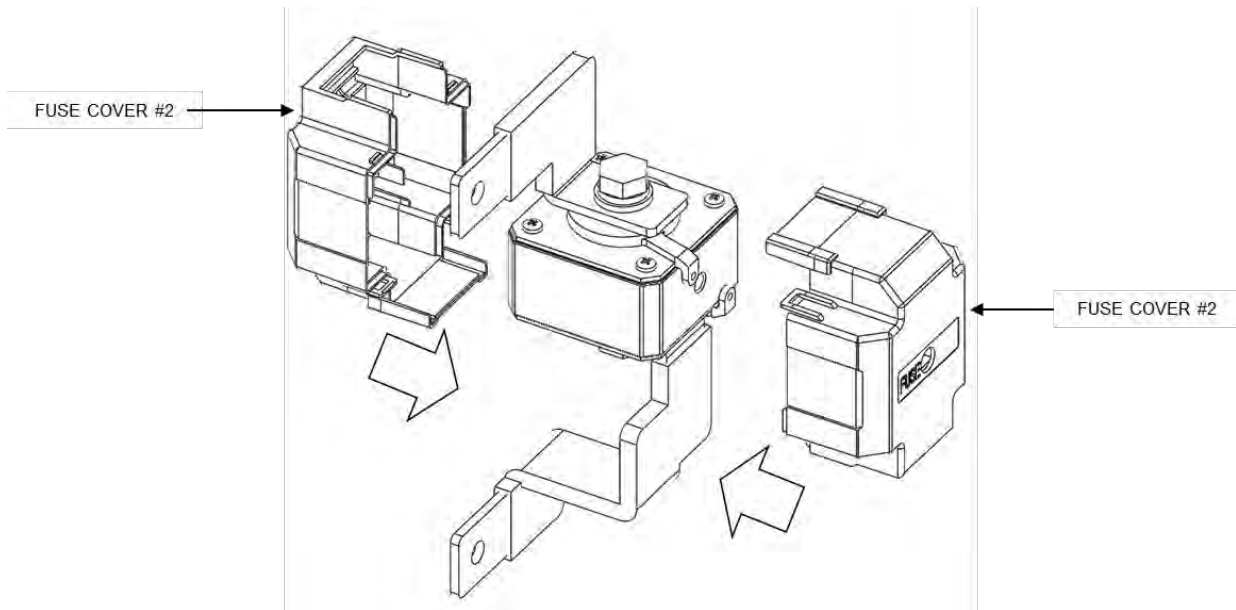

Figure 3-33: Fuse Busbar Left Assembly (Fuse Cover)

### 3. Installing the Product

#### 3. Assemble the Fuse Busbar Right Assembly.

Fuse Busbar Right Assembly is comprised of one "FUSE BUSBAR RIGHT UPPER", one one "FUSE BUSBAR RIGHT LOWER", two "SCREW M12 X 16", two "FUSE COVER #2", and one "FUSE"

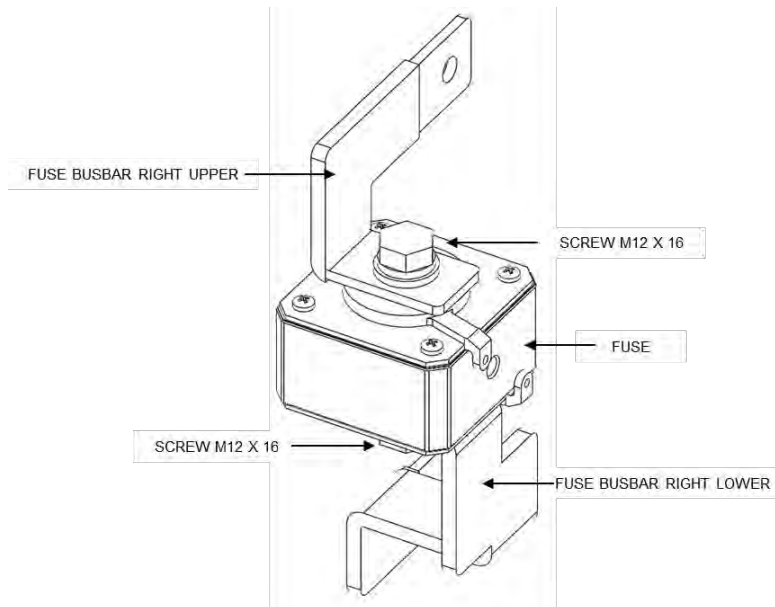

Figure 3-34: Fuse Busbar Right Assembly

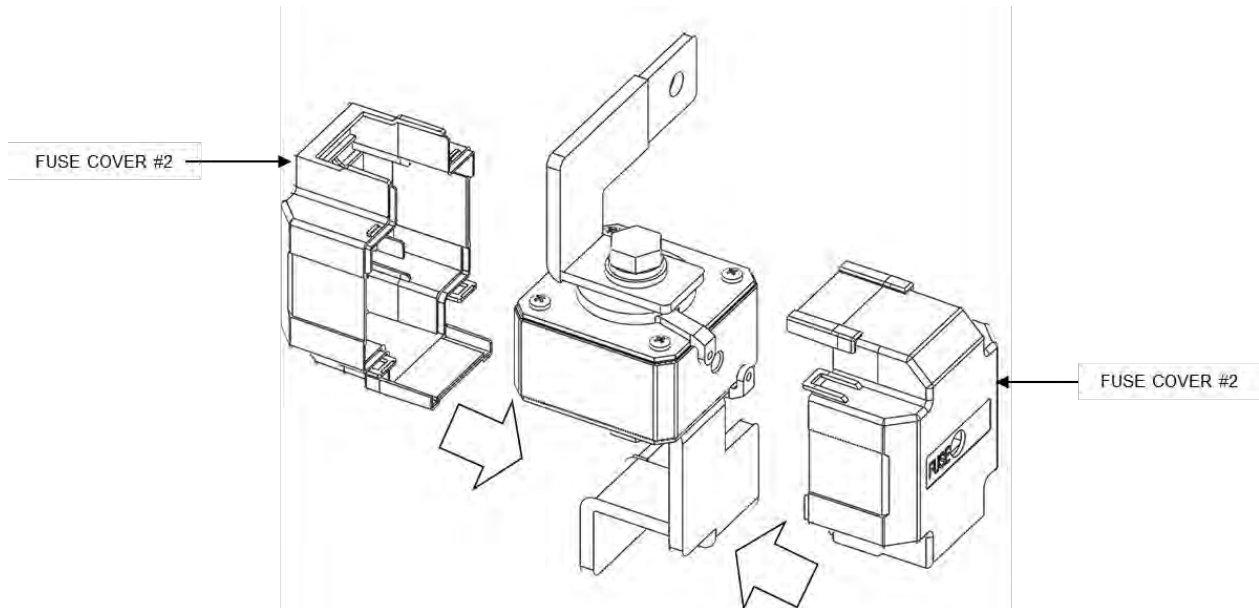

Figure 3-35: Fuse Busbar Right Assembly (Fuse Cover)

### 3.10.5 Busbar Installation

Connect the power busbars between modules



**Verify with a voltmeter that no power is present on the system.**  
**Use lock out/tag out procedures to secure the UPS and batteries.**

	<b>CAUTION</b>
	<ul style="list-style-type: none"> <li>▪ Please follow the instructions to protect the module BMS against damage.</li> <li>▪ Important: DO NOT deviate from the sequence of steps below.</li> <li>▪ The system’s voltage will increase proportionally as battery modules are connected. Exercise extreme caution to prevent the terminals from contacting anything except their intended mounting points.</li> <li>▪ Terminals and their connected wires have either positive or negative polarity (Positive: B+, P+; Negative: B-, P-). The polarity of a terminal or a wire connected to the terminal is on the front of each module and SMU. Exercise extreme caution to prevent the terminals and/or wires with opposite polarity from contacting with each other.</li> <li>▪ It is recommended not to touch the battery positive(+) or negative(-) terminal for the batteries with rack frame. There is no evidence of dielectric breakdown because of electrical isolation between the battery positive (+) or negative (-) terminals and rack frame. However, it is recommended not to touch them for safety because It is possible to touch between battery positive (+) and negative (-) through the rack frame.</li> </ul>

	<b>NOTICE</b>
	<ul style="list-style-type: none"> <li>▪ Connect the power busbar with an M8 screw for battery module terminals</li> <li>▪ The fastening torque should be 12.2–14.0 Nm (124–142 kgf/cm).</li> <li>▪ Use an insulated torque wrench extension with a 13 mm socket.</li> <li>▪ After torquing, torque mark the screws using a colored marker or a torque seal.</li> </ul>

	<b>NOTICE</b>
	<ul style="list-style-type: none"> <li>▪ Connect the power bus-bar with an M12 screw for SMU terminals</li> <li>▪ The fastening torque should be 30 Nm/300 kgf.cm.</li> <li>▪ Use an insulated torque wrench extension with a 19 mm socket.</li> <li>▪ After torquing, torque mark the screws using a colored marker or a torque seal.</li> </ul>

	<b>Important</b>
	<ul style="list-style-type: none"> <li>▪ The power terminals, such as “B+,” “B-,” “P+,” and “P-,” of the module and SMU are covered with the power terminal cover to guard against a short circuit.</li> <li>▪ At each step in this process, you must remove the cover prior to connecting a power busbar and reattach the cover immediately after connecting the power busbars.</li> </ul>

### 3. Installing the Product

	<p><b>Important</b></p> <ul style="list-style-type: none"> <li>It is recommended to polish the joining surface of the bus bars prior to assembly. Polish the joining surface of the busbar with a fine abrasive material (grit 600 or higher) such as sandpaper or scrubbing pad. Polish until the surface is evenly scratched and the color is equivalent of “freshly polished” on color chart used in ASTM D-130 Copper Strip Corrosion Standards. Refer to Figure 3-36: Copper Busbar Appearance.</li> <li>It is recommended to apply electrically conductive grease on the joining surface to reduce the contact resistance. After polishing the surface of the busbar, apply the grease on the busbar and spread it evenly and thinly on the surface using a wire brush or a dry cloth. Refer to Figure 3-37: Conductive Grease on Busbar for the application of the grease on the busbar.</li> </ul>
---	--

	<p><b>NOTICE</b></p>
	<ul style="list-style-type: none"> <li>After polishing the busbar, make sure the metallic particle does not settle on the electronics. Clean the surface with a dry cloth before assembling the busbar to the terminal.</li> </ul>

	<p><b>NOTICE</b></p>
	<ul style="list-style-type: none"> <li>As a reference, grease used by Samsung SDI for internal testing is “Ox-Gard Anti-Oxidant Compound OX-400N”. Electrical conductivity, thermal and chemical characteristics of the grease must be properly checked and tested before use.</li> <li>When applying the grease, make sure there is none on the screw threads.</li> </ul>



Not Polished

Freshly Polished

Figure 3-36: Copper Busbar Appearance



Grease Applied

Grease Spread on Surface

Figure 3-37: Conductive Grease on Busbar

	<b>NOTICE</b>
	<ul style="list-style-type: none"><li>▪ After connecting the busbar to the terminals (battery module, SMU, fuse), measure the contact resistance between the terminals and the busbars using a low resistance meter. Refer to Figure 3-38: Contact Resistance Probe Points (Battery Module Terminal to Busbar) for location of the measurement. Use similar probe locations for SMU terminal to busbar contact resistance, and fuse to busbar contact resistance. Make sure each probe is in contact with only the intended location.</li><li>▪ The contact resistance must be measured below <math>40\mu\Omega</math>. It is recommended to keep the contact resistance in all terminals below <math>30\mu\Omega</math>.</li></ul>

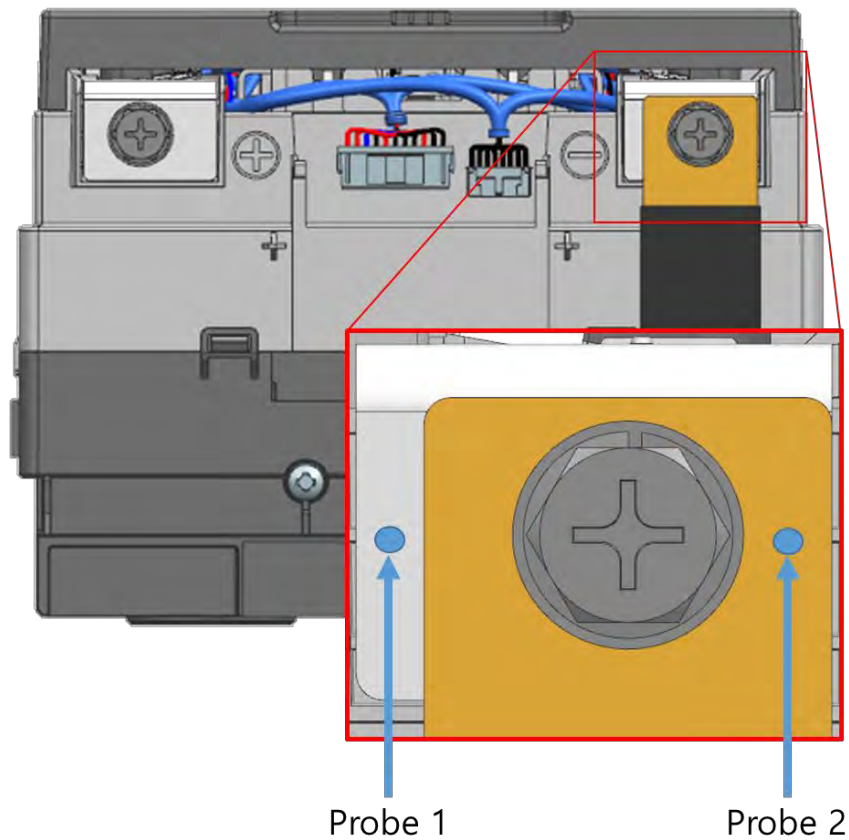

Figure 3-38: Contact Resistance Probe Points (Battery Module Terminal to Busbar)

### 3. Installing the Product

---

1. Remove Battery Module #1's front cover and the SMU B- terminal cover.

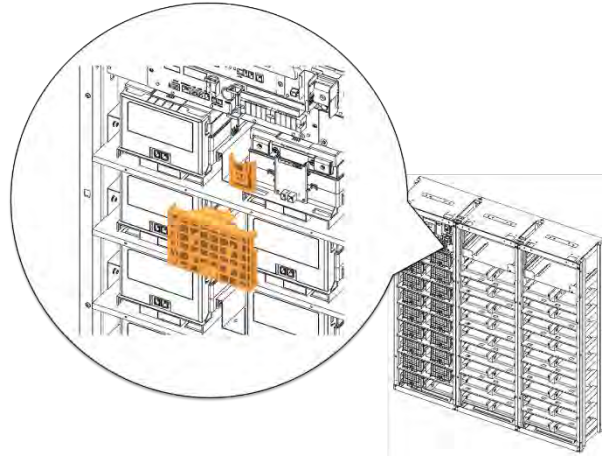

Figure 3-39: Removing the Module #1's Cover and SMU B- Terminal Cover

2. Connect SMU B- and Module #1 B- using "BUSBAR M TO SMU." SMU B- terminal is connected using an M12 screw and Battery Module #1 B- terminal is connected using an M8 screw. Measure the contact resistance between the terminals and the bus bar.

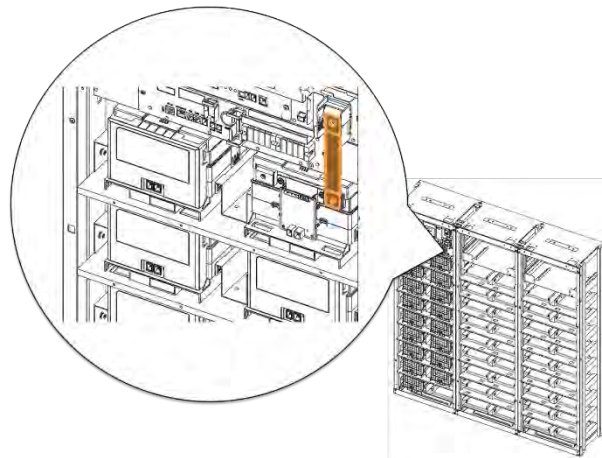

Figure 3-40: Connect SMU B- and Module #1 B-



3. Reattach SMU's B- terminal cover.

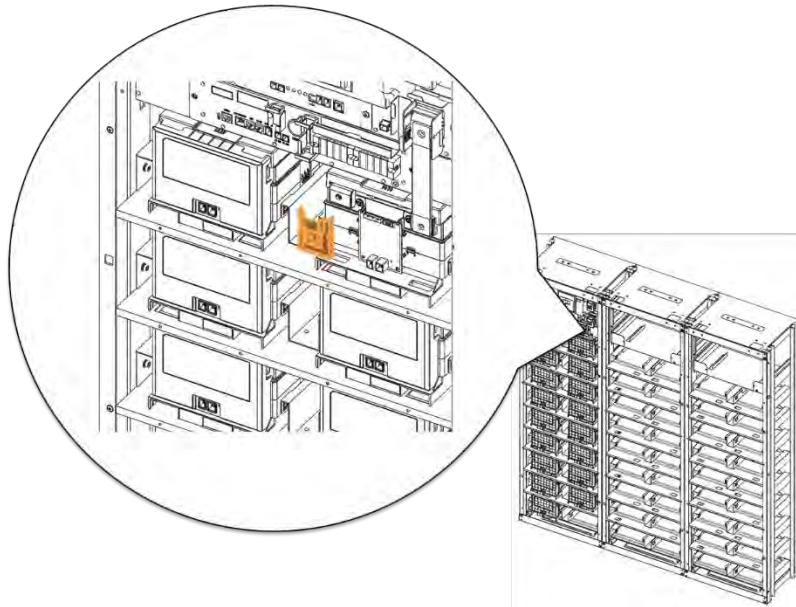

Figure 3-41: Restore SMU's B- Terminal

4. Remove Battery Module #2's front cover.

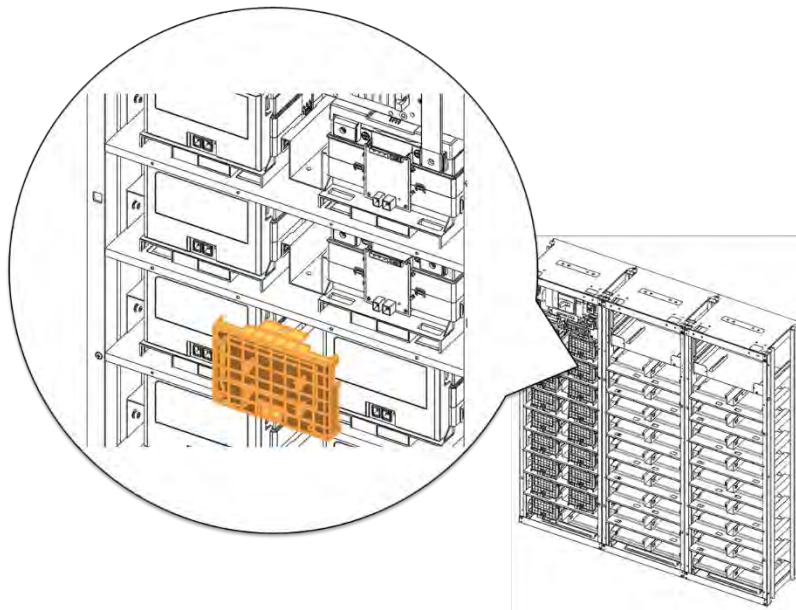

Figure 3-42: Remove Battery Module #2's Front Cover

### 3. Installing the Product

5. Connect Battery Module #1 B+ and Module #2 B- using "BUS-BAR MAIN." Connect using an M8 screw. Measure the contact resistance between the terminal and the bus bar.

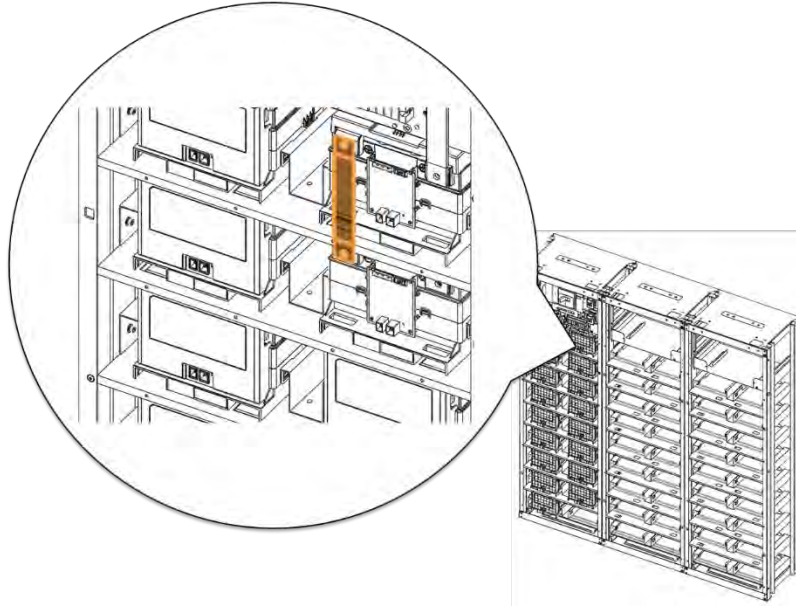

Figure 3-43: Connect Battery Module #1 B+ and Battery Module #2 B-.

6. Reattach Battery Module #1's front cover and remove Battery Module #3's front cover.

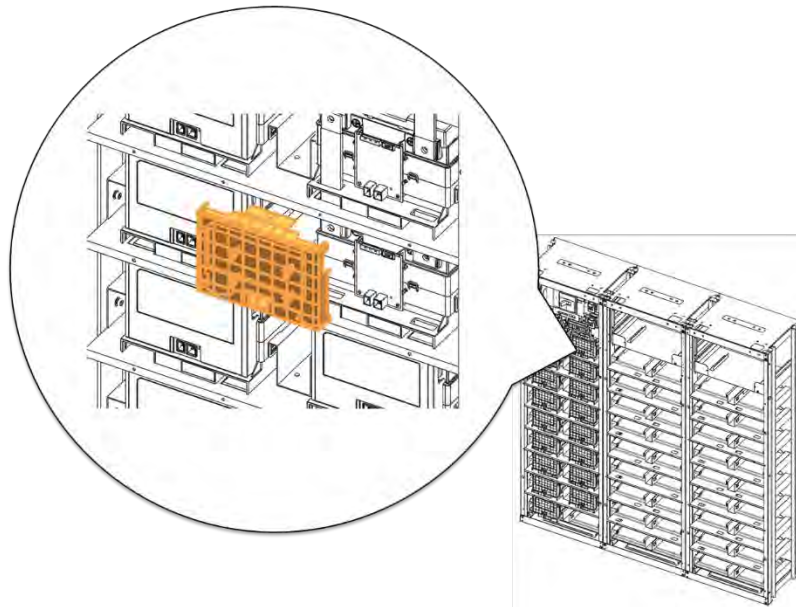

Figure 3-44: Reattach Battery Module #1's Front Cover

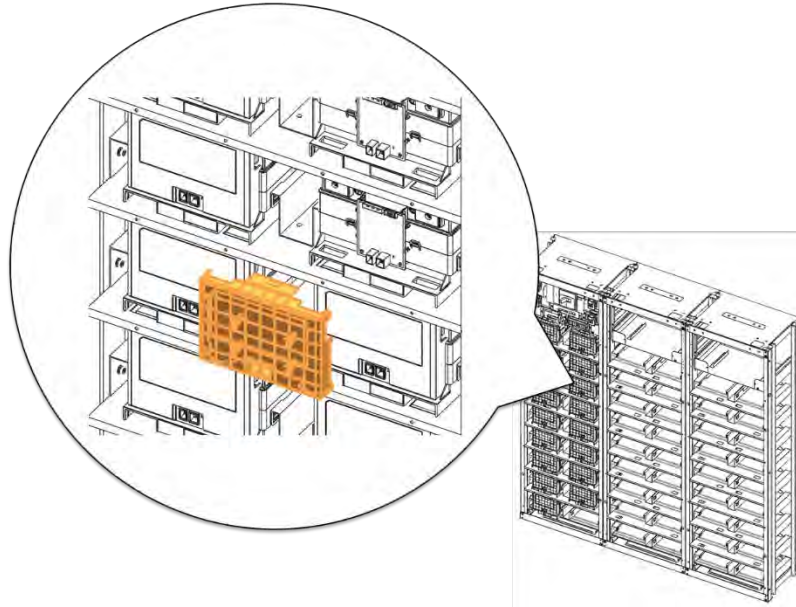

Figure 3-45: Remove Battery Module #2's Front Cover

7. Connect Battery Module #2 B+ and Battery Module #3 B- using "BUS-BAR MAIN." Connect using an M8 screw. Measure the contact resistance between the terminal and the bus bar.

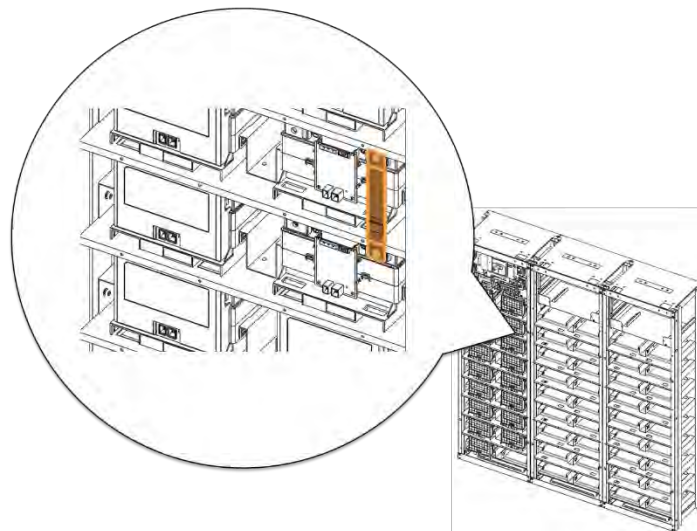

Figure 3-46: Connect Battery Module #2 B+ and Battery Module #3 B-.

### 3. Installing the Product

---

8. Reattach Battery Module #2's front cover and remove Battery Module #4's front cover.

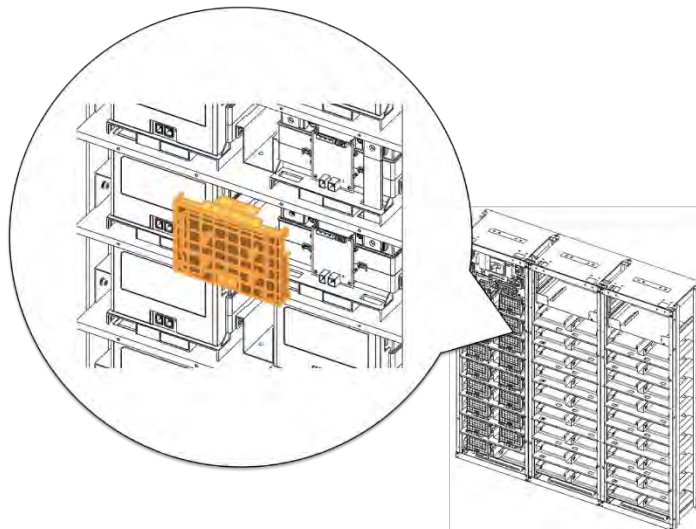

Figure 3-47: Reattach Battery Module #2's Front Cover

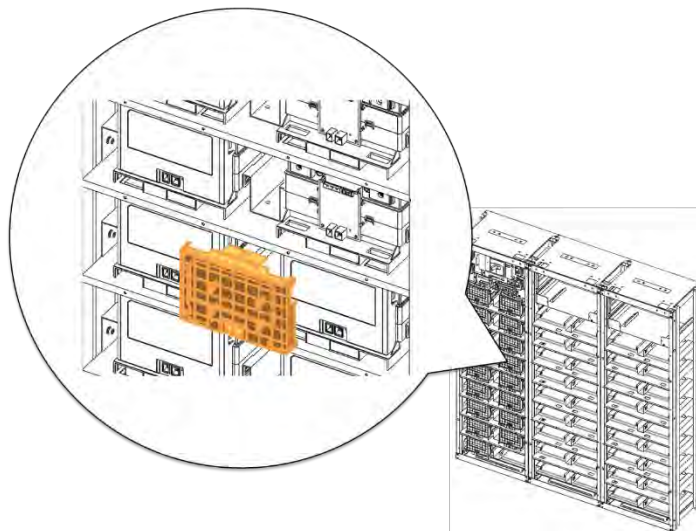

Figure 3-48: Remove Battery Module #4's Front Cover

9. Connect Battery Module #3 B+ and Module #4 B- using "BUS-BAR MAIN." Connect using an M8 screw. Measure the contact resistance between the terminal and the bus bar.

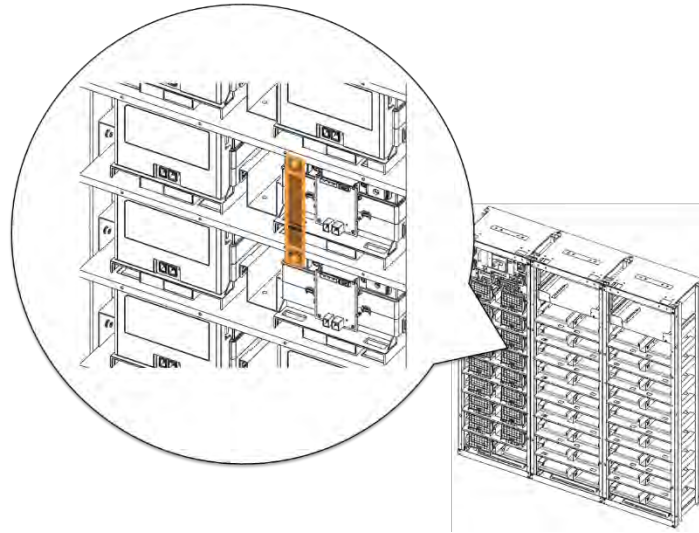

Figure 3-49: Connect Battery Module #3 B+ and Module #4 B-.

### 3. Installing the Product

---

**10.** Reattach Battery Module #3's front cover and remove Battery Module #5's front cover.

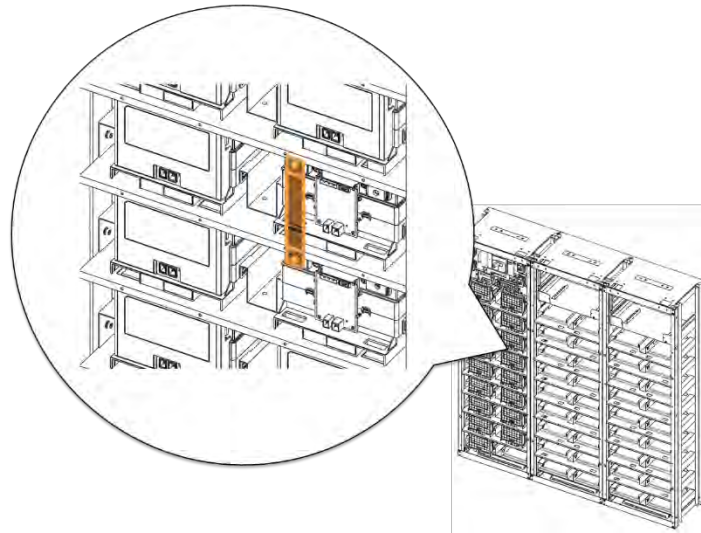

Figure 3-50: Reattach Battery Module #3's Front Cover

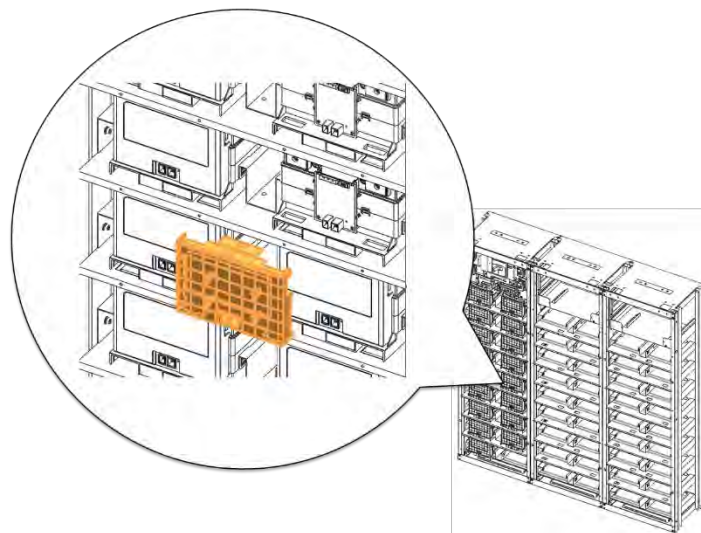

Figure 3-51: Remove Battery Module #5's Front Cover

11. Connect Battery Module #4 B+ and Battery Module #5 B- using "BUS-BAR MAIN." Connect using an M8 screw. Measure the contact resistance between the terminal and the bus bar.

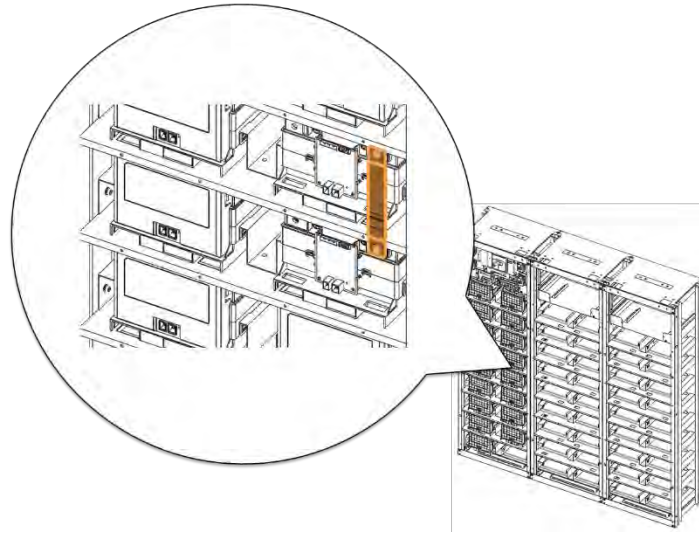

Figure 3-52: Connect Battery Module #4 B+ and Battery Module #5 B-.

### 3. Installing the Product

---

12. Reattach Battery Module #4's front cover and remove Battery Module #6's front cover.

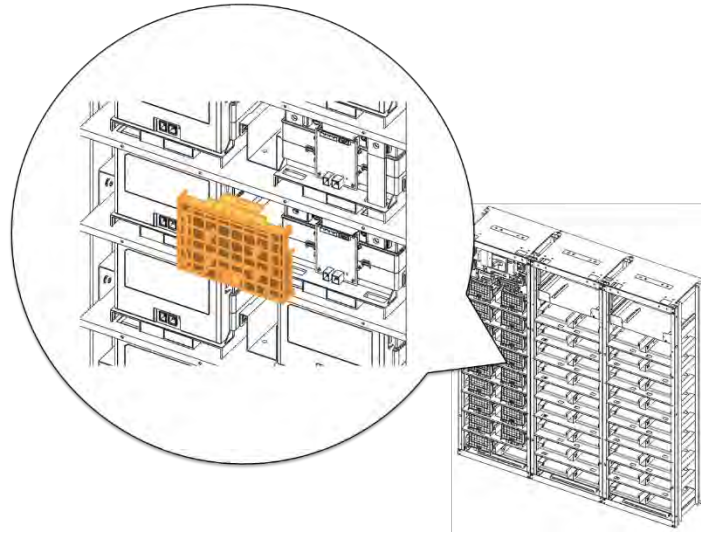

Figure 3-53: Reattach Battery Module #4's Front Cover

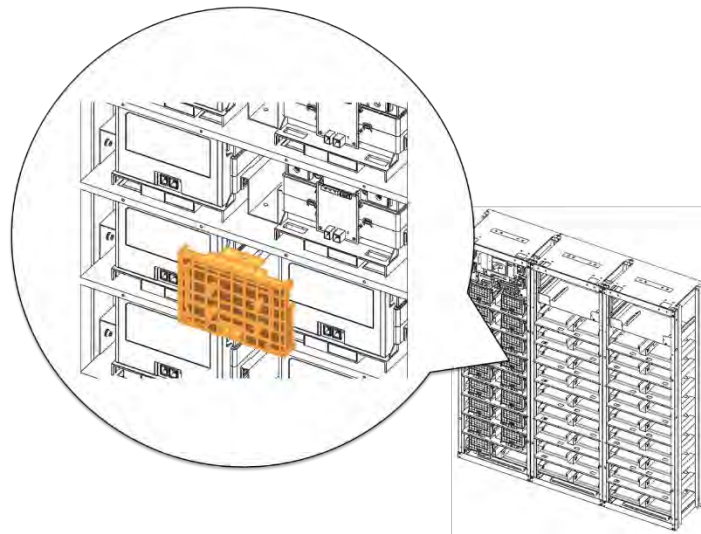

Figure 3-54: Remove Battery Module #6's Front Cover



- 13.** Connect Battery Module #5 B+ and Battery Module #6 B- using "FUSE BUSBAR RIGHT ASSEMBLY". Connect using an M8 screw. Measure the contact resistance between the terminal and the bus bar.

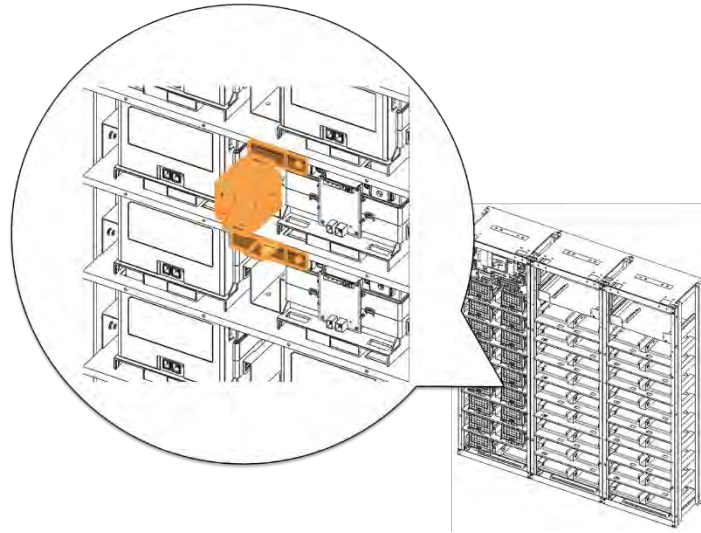

Figure 3-55: Connect Battery Module #5 B+ and Battery Module #6 B-.

### 3. Installing the Product

---

14. Reattach Battery Module #5's front cover and remove Battery Module #7's front cover.

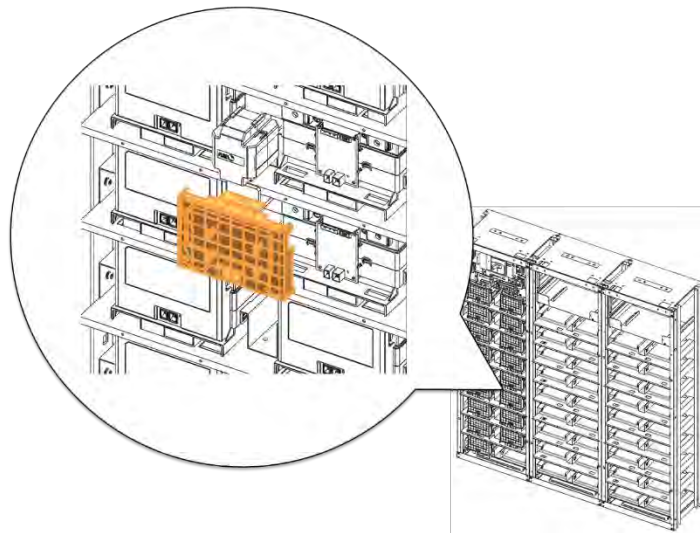

Figure 3-56: Reattach Battery Module #5's Front Cover

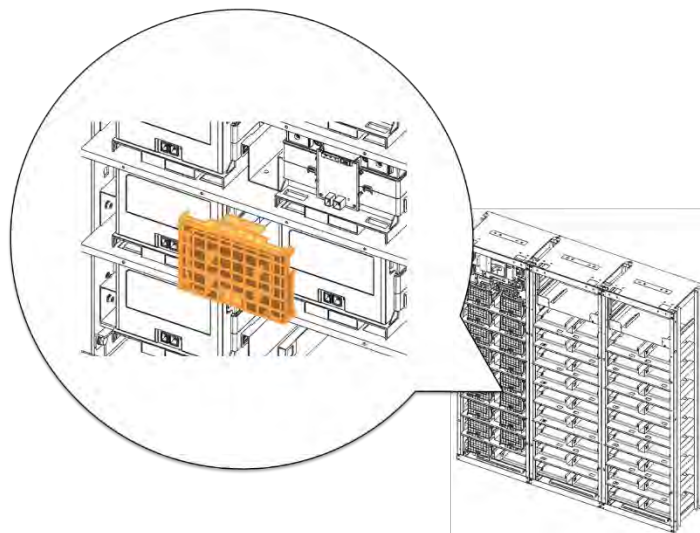

Figure 3-57: Remove Battery Module #7's Front Cover

15. Connect Battery Module #6 B+ and Battery Module #7 B- using "BUS-BAR MAIN." Connect using an M8 screw. Measure the contact resistance between the terminal and the bus bar.

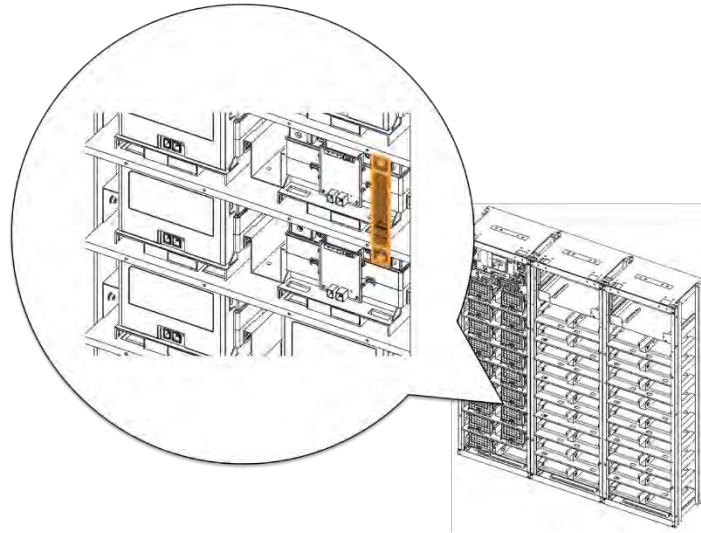

Figure 3-58: Connect Battery Module #6 B+ and Battery Module #7 B-

### 3. Installing the Product

---

**16.** Reattach Battery Module #6's front cover and remove Battery Module #8's front cover.

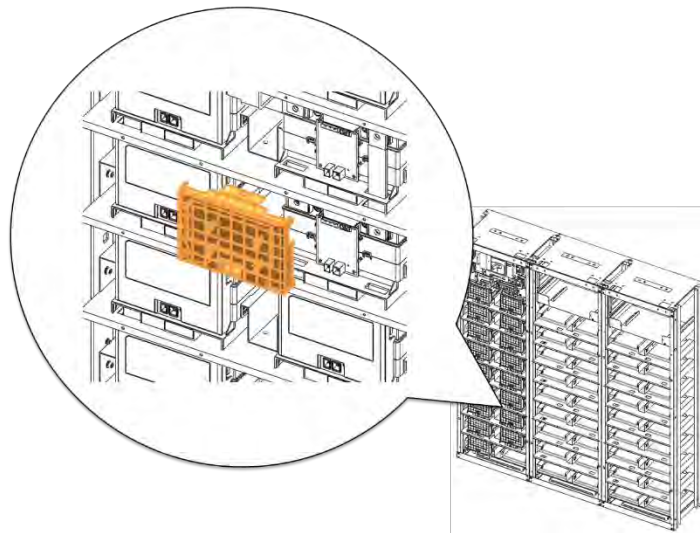

Figure 3-59: Reattach Battery Module #6's Front Cover

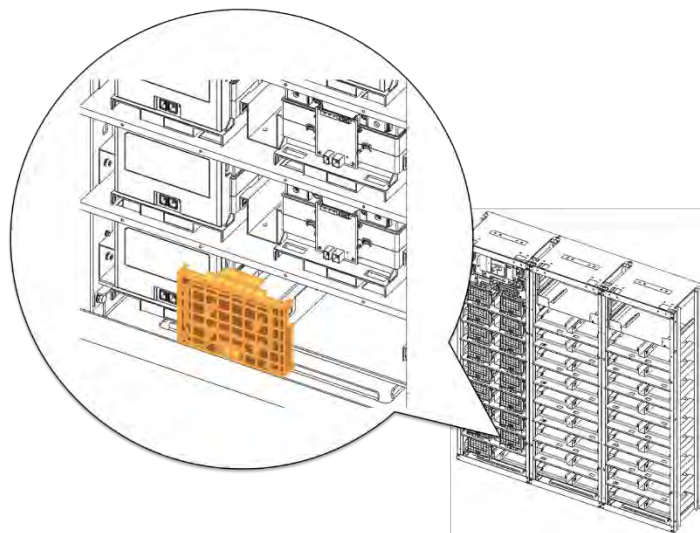

Figure 3-60: Remove Battery Module #8's Front Cover

17. Connect Battery Module #7 B+ and Battery Module #8 B- using "BUS-BAR MAIN." Connect using an M8 screw. Measure the contact resistance between the terminal and the bus bar.

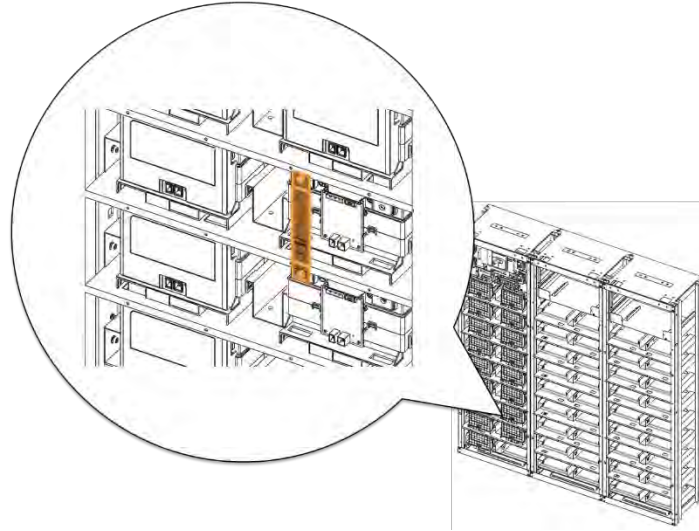

Figure 3-61: Connect Battery Module #7 B+ and Battery Module #8 B-

18. Reattach Battery Modules #7's front cover and remove Battery Modules #9's front cover.

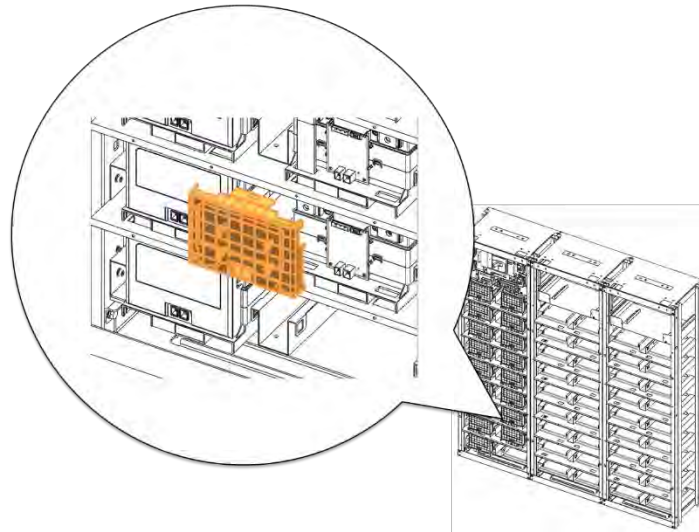

Figure 3-62: Reattach Battery Modules #7's Front Cover

### 3. Installing the Product

---

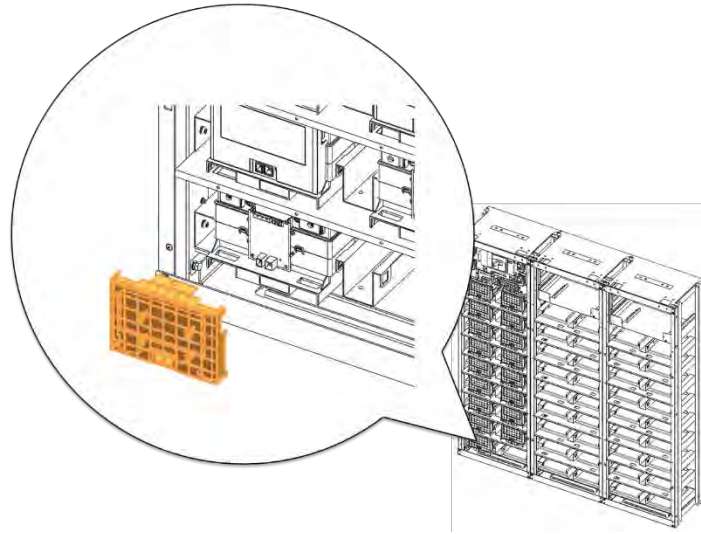

Figure 3-63: Remove Battery Modules #9's Front Cover

- 19.** Connect Battery Module #8 B+ and Battery Module #9 B- using "RACK FUSE BUSBAR ASSEMBLY" Connect using an M8 screw. Measure the contact resistance between the terminal and the bus bar.

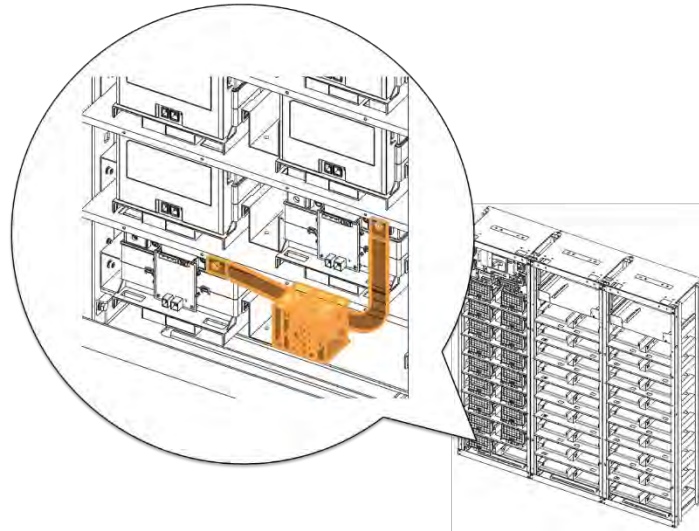

Figure 3-64: Connect Battery Module #8 B+ and Battery Module #9 B-.

- 20.** Reattach Battery Module #8's front cover and remove Battery Module #10's front cover.

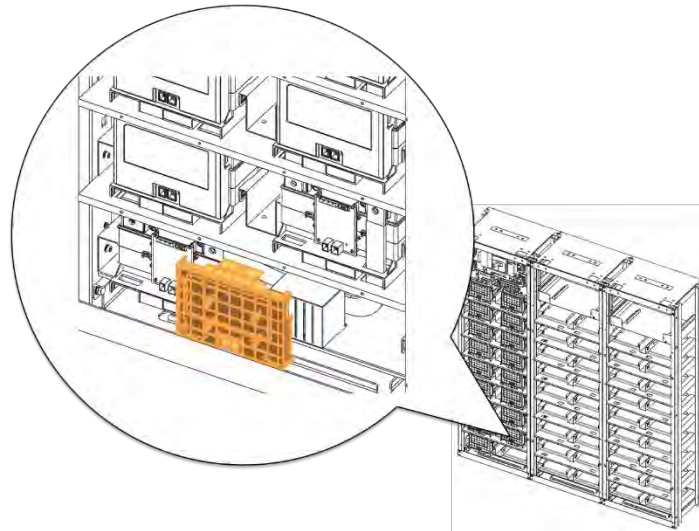

Figure 3-65: Reattach Battery Modules #8's Front Cover

### 3. Installing the Product

---

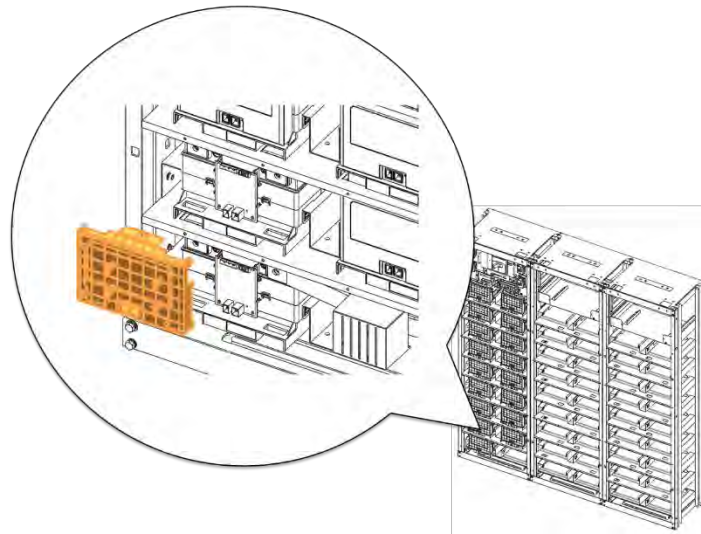

Figure 3-66: Remove Battery Modules #10's Front Cover

**21.** Connect Battery Module #9 B+ and Battery Module #10 B- using "BUS-BAR MAIN" Connect using an M8 screw. Measure the contact resistance between the terminal and the bus bar.

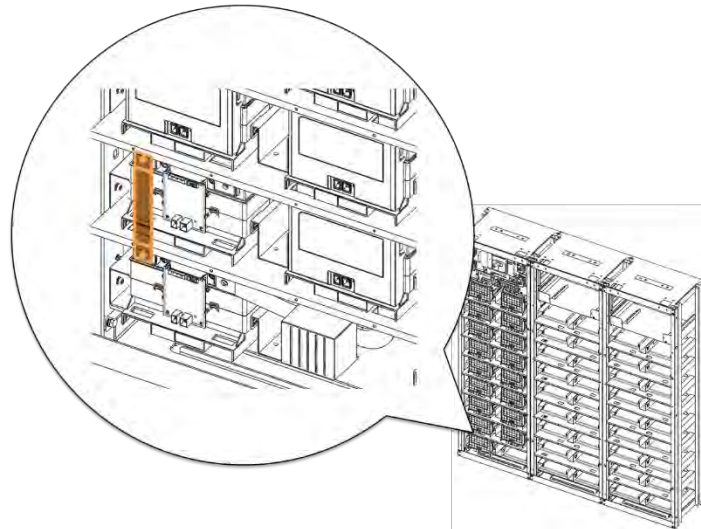

Figure 3-67 Connect Battery Module #9 B+ and Battery Module #10 B-.

**22.** Reattach Battery Module #9's front cover and remove Battery Module #11's front cover.



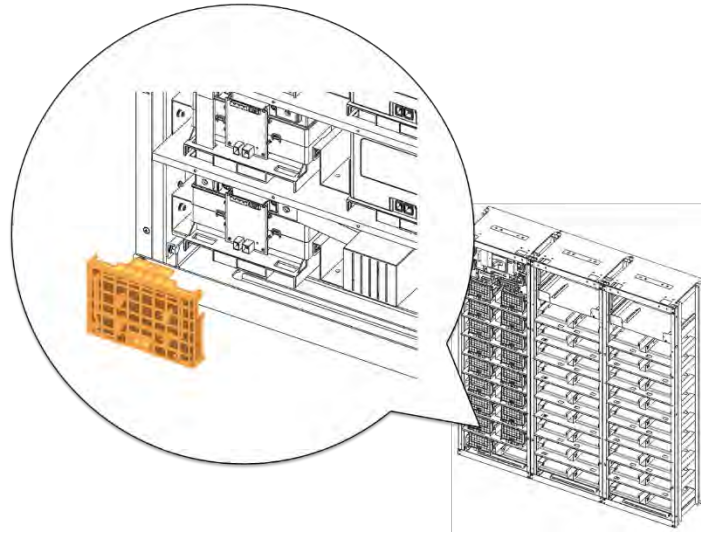

Figure 3-68: Reattach Battery Module #9's Front Cover

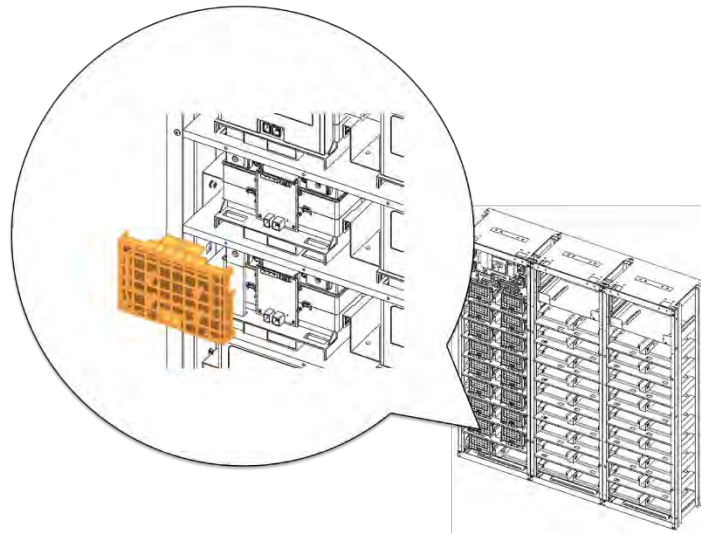

Figure 3-69: Remove Battery Module #11's Front Cover

### 3. Installing the Product

---

**23.** Connect Battery Module #10 B+ and Battery Module #11 B- using "BUS-BAR MAIN." Connect using an M8 screw. Measure the contact resistance between the terminal and the bus bar.

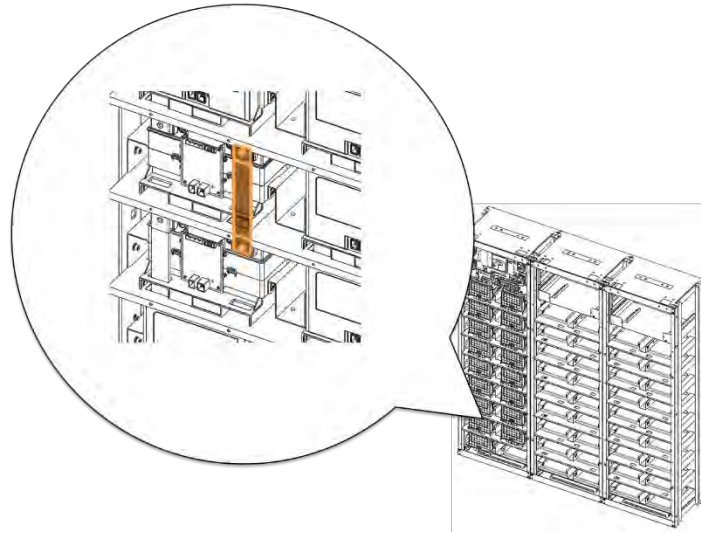

Figure 3-70: Connect Battery Module #10 B+ and Battery Module #11 B-.

24. Reattach Battery Module #10's front cover and remove Module #12's front cover.

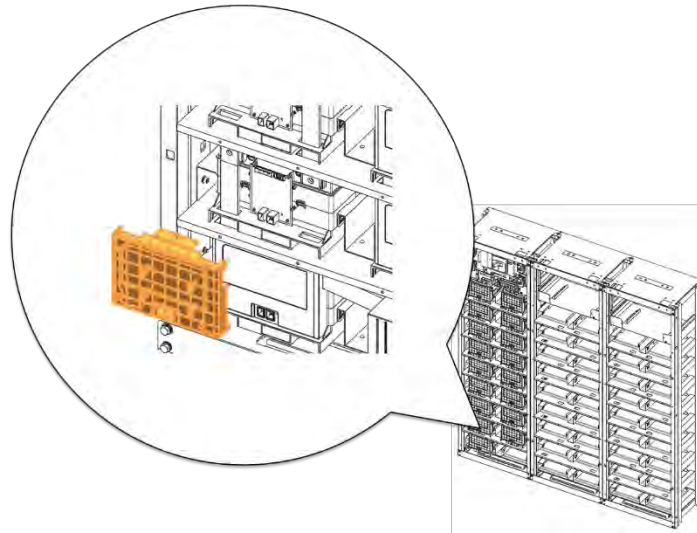

Figure 3-71: Reattach Battery Module #10's Front Cover

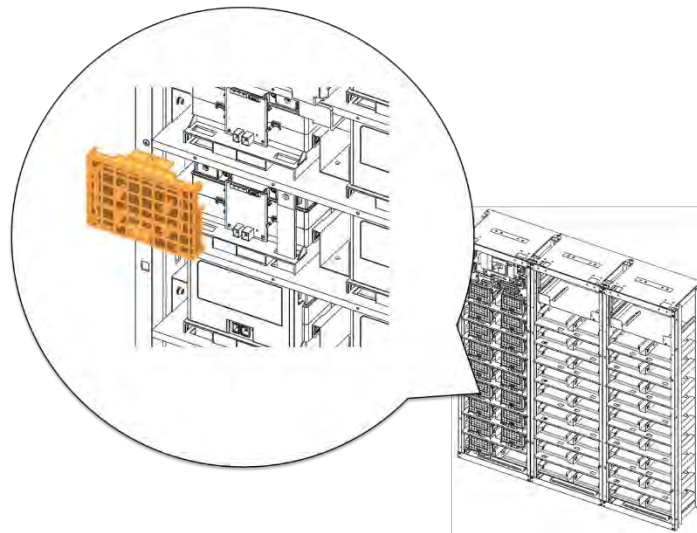

Figure 3-72: Remove Battery Module #12's Front Cover

### 3. Installing the Product

---

**25.** Connect Battery Module #11 B+ and Battery Module #12 B- using "BUS-BAR MAIN." Connect using an M8 screw. Measure the contact resistance between the terminal and the bus bar.

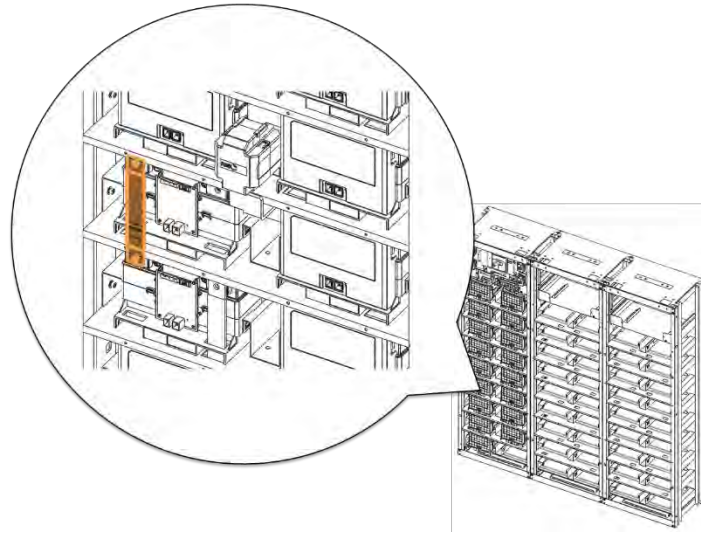

Figure 3-73: Connect Battery Module #11 B+ and Battery Module #12 B-.

26. Reattach Battery Module #11's front cover and remove Battery Module #13's front cover.

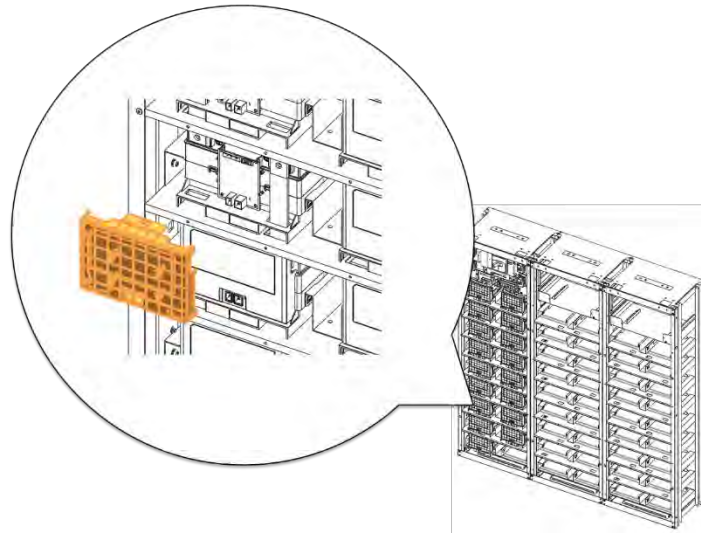

Figure 3-74: Reattach Module #11's Front Cover

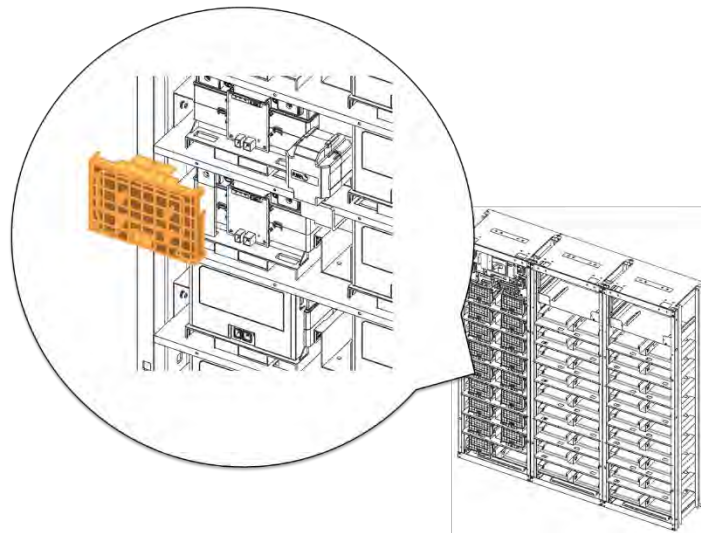

Figure 3-75: Remove Module #13's Front Cover

### 3. Installing the Product

---

**27.** Connect Battery Module #12 B+ and Battery Module #13 B- using "BUS-BAR MAIN." Connect using an M8 screw. Measure the contact resistance between the terminal and the bus bar.

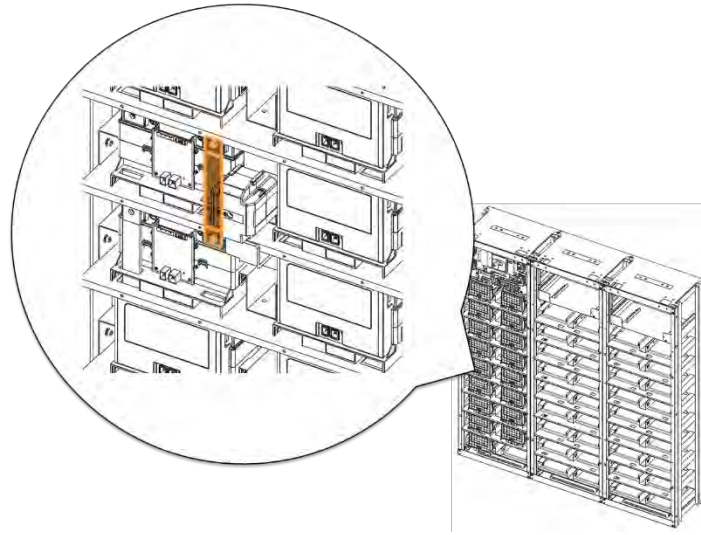

Figure 3-76: Connect Battery Module #12B+ and Battery Module #13 B-.

28. Reattach Battery Module #12's front cover and remove Battery Module #14's front cover.

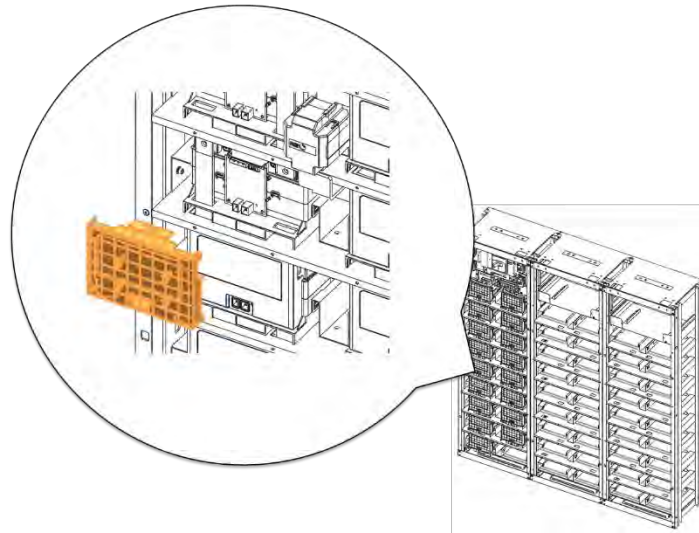

Figure 3-77: Reattach Module #12's Front Cover

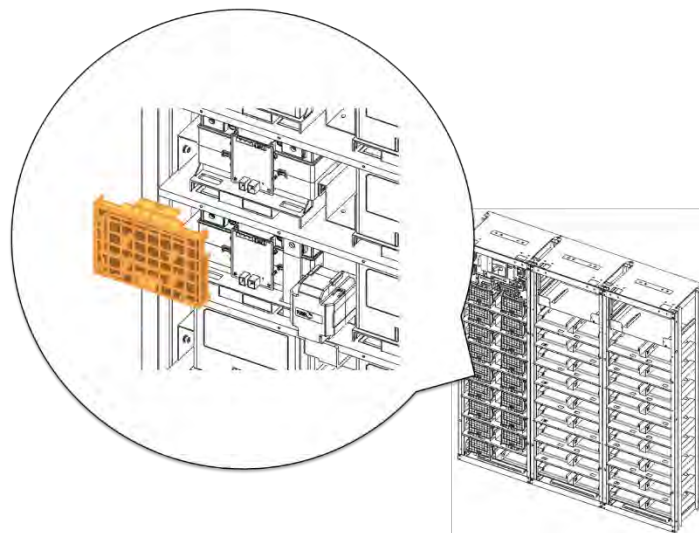

Figure 3-78: Remove Battery Module #14's Front Cover

### 3. Installing the Product

---

**29.** Connect Battery Module #13 B+ and Battery Module #14 B- using "BUS-BAR MAIN." Connect using an M8 screw. Measure the contact resistance between the terminal and the bus bar.

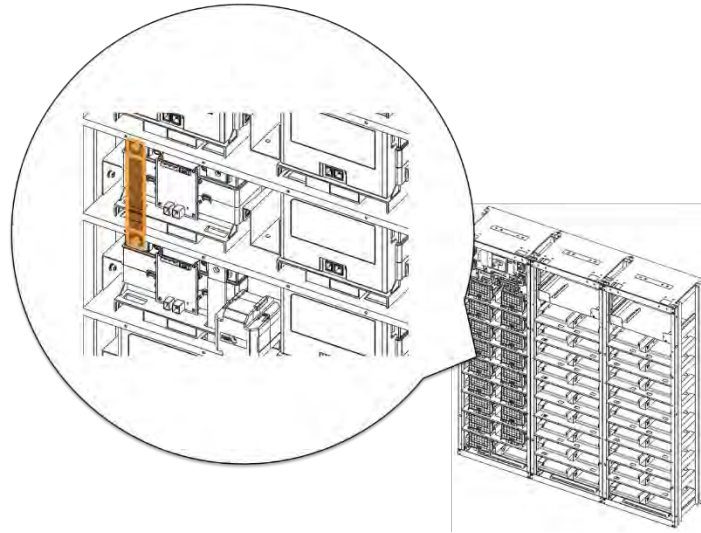

Figure 3-79: Connect Battery Module #13 B+ and Battery Module #14 B-.



30. Reattach Battery Module #13's front cover and remove Battery Module #15's front cover.

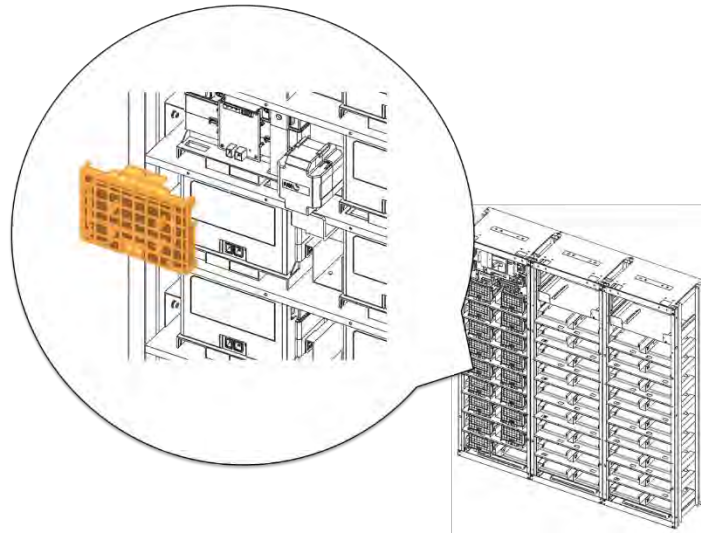

Figure 3-80: Reattach Battery Module #13's Front Cover

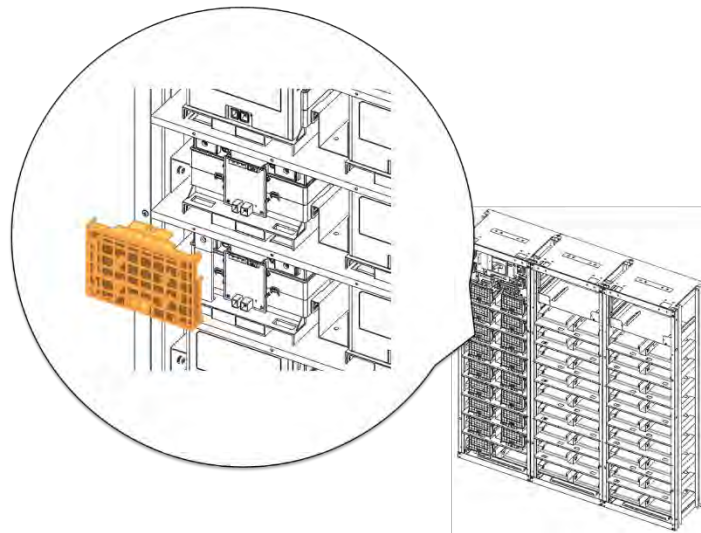

Figure 3-81: Remove Battery Module #15's Front Cover

### 3. Installing the Product

---

- 31.** Connect Battery Module #14 B+ and Battery Module #15 B- using "FUSE BUSBAR LEFT ASSEMBLY." Connect using an M8 screw. Measure the contact resistance between the terminal and the bus bar.

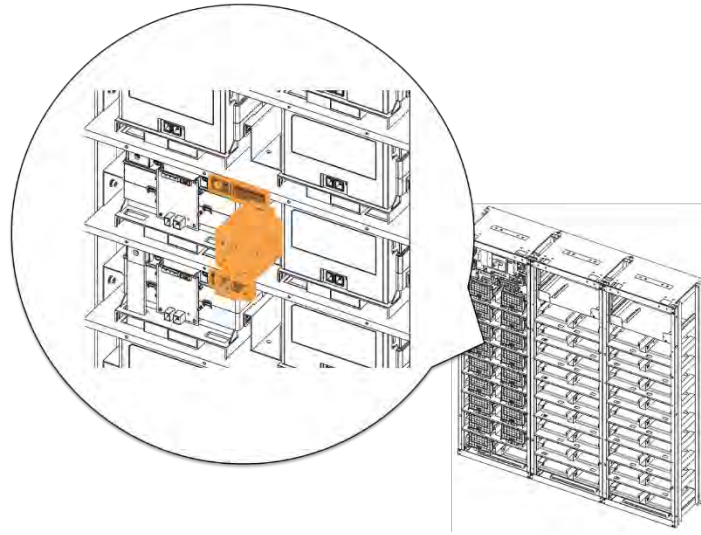

Figure 3-82: Connect Battery Module #14 B+ and Battery Module #15 B-.

32. Reattach Battery Module #14's front cover and remove Battery Module #16's front cover.

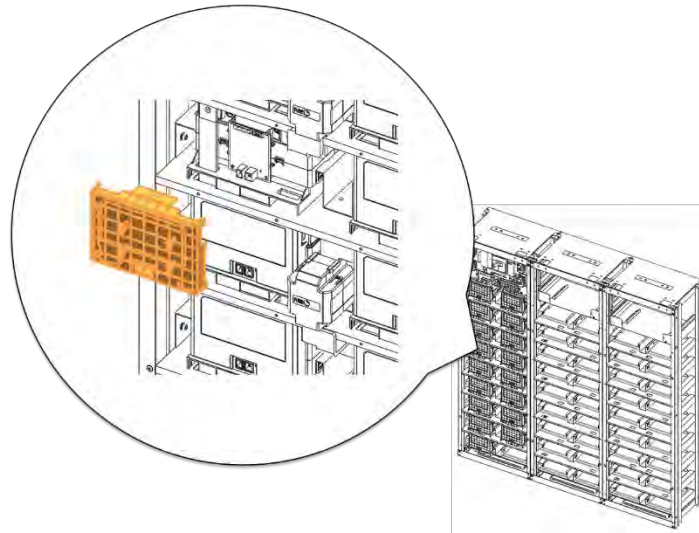

Figure 3-83: Reattach Battery Module #14's Front Cover

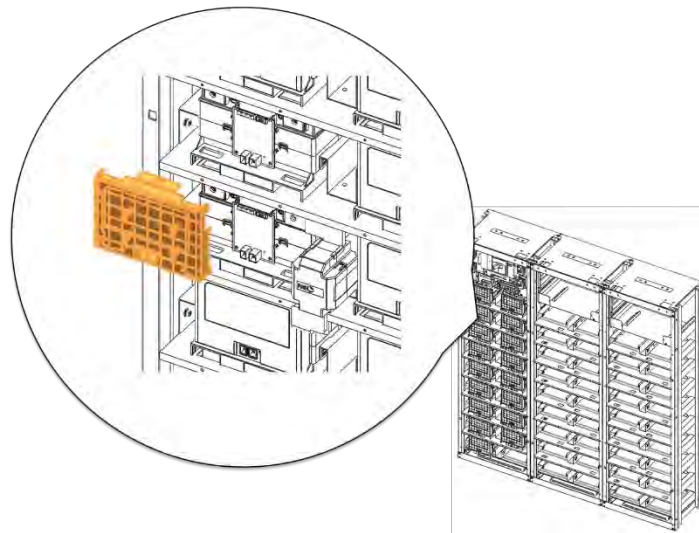

Figure 3-84: Remove Battery Module #16's Front Cover

### 3. Installing the Product

---

**33.** Connect Battery Module #15 B+ and Battery Module #16 B- using "BUS-BAR MAIN." Connect using an M8 screw. Measure the contact resistance between the terminal and the bus bar.

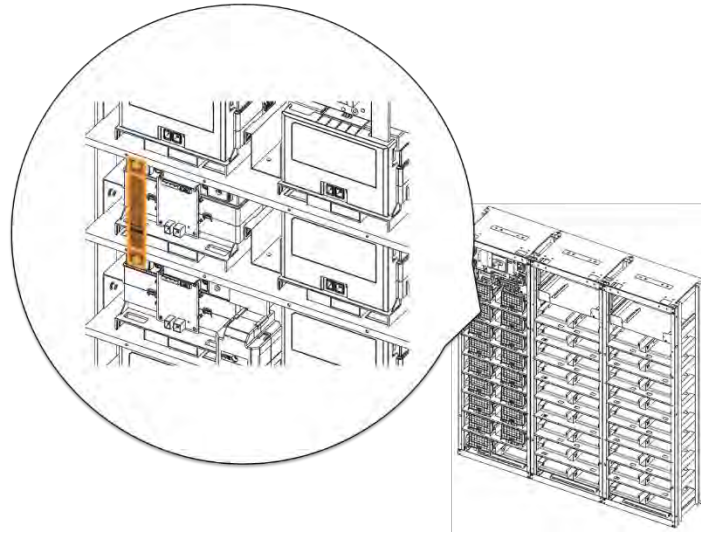

Figure 3-85: Connect Battery Module #15 B+ and Battery Module #16 B-.

34. Reattach Battery Module #15's front cover and remove Battery Module #17's front cover.

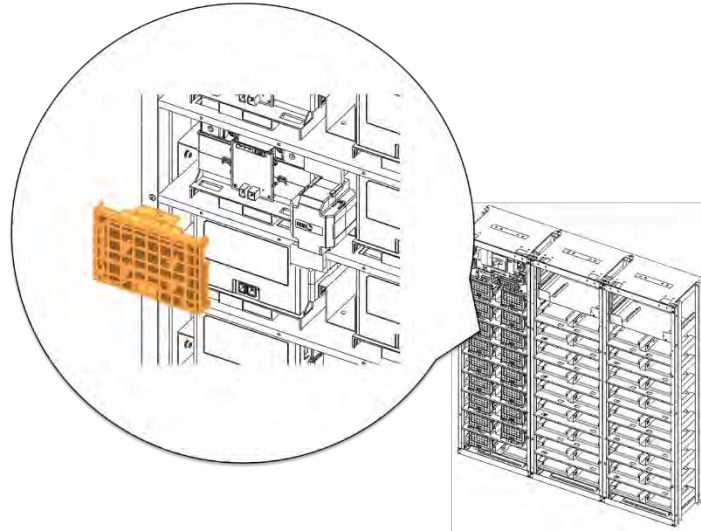

Figure 3-86: Reattach Battery Module #15's Front Cover

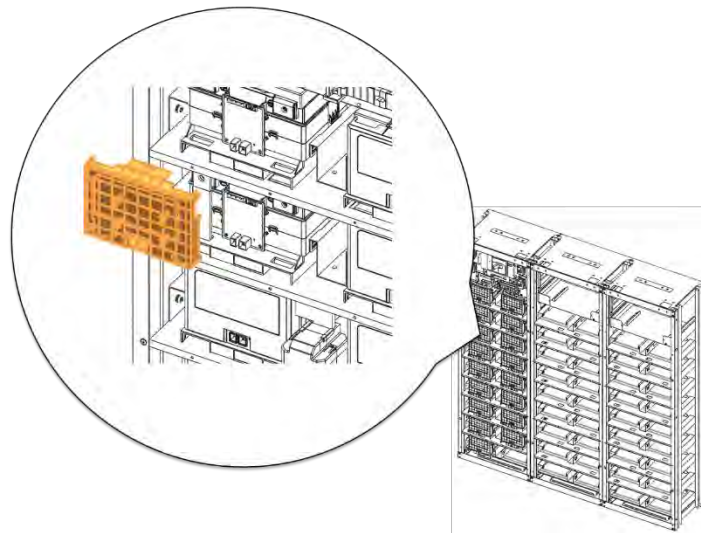

Figure 3-87: Remove Battery Module #17's Front Cover

### 3. Installing the Product

---

**35.** Connect Battery Module #16 B+ and Battery Module #17 B- using "BUS-BAR MAIN". Connect using M8 screw. Measure the contact resistance between the terminal and the bus bar.

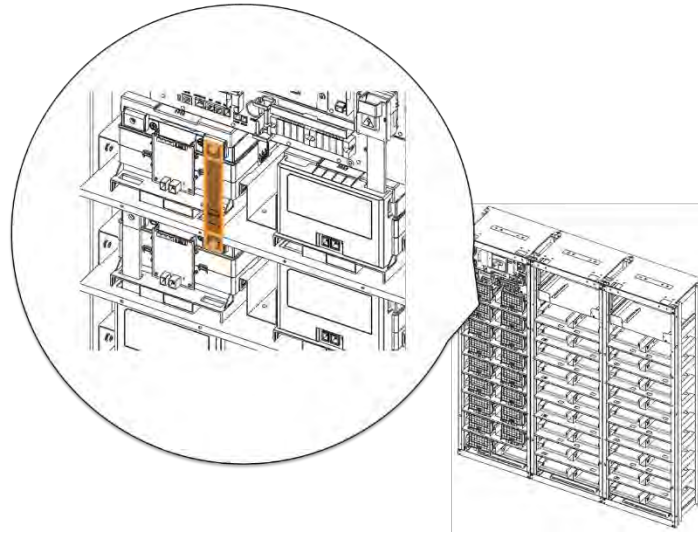

Figure 3-88: Connect Battery Module #16 B+ and Battery Module #17 B-.

36. Reattach Battery Module #16's front cover and remove SMU's B+ terminal cover.

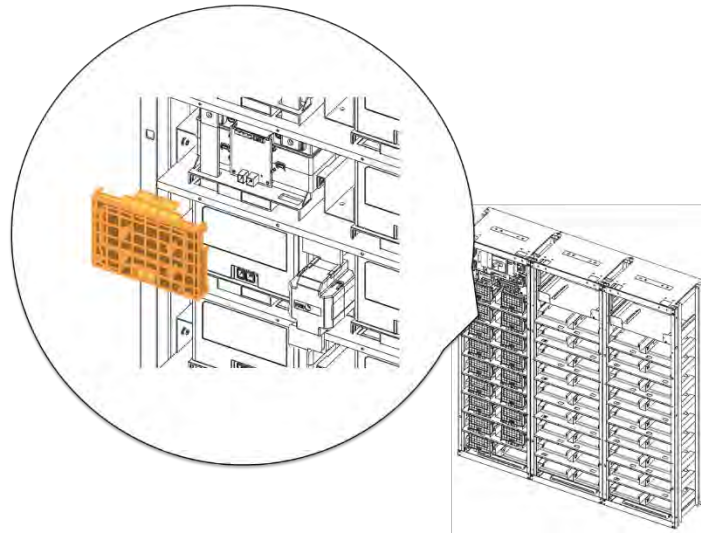

Figure 3-89: Reattach Battery Module #15's Front Cover

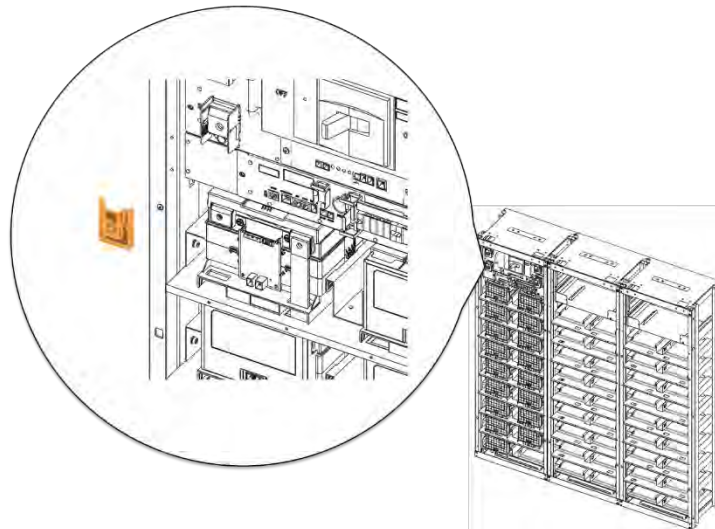

Figure 3-90: Remove SMU B+ Terminal Cover

### 3. Installing the Product

- 37.** Connect SMU B+ and Battery Module #17 B+ using “BUSBAR M TO SMU.” SMU B+ terminal is connected using an M12xL25 screw and Module #17 B+ terminal is connected using an M8 screw. Measure the contact resistance between the terminal and the bus bar.

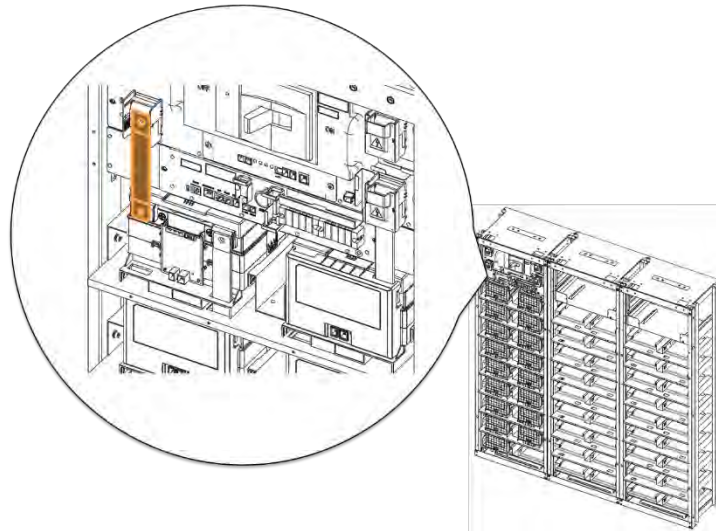

Figure 3-91: Connect SMU B+ and Module #17 B+.

- 38.** Reattach Battery Module #17's front cover and SMU B+ terminal cover.

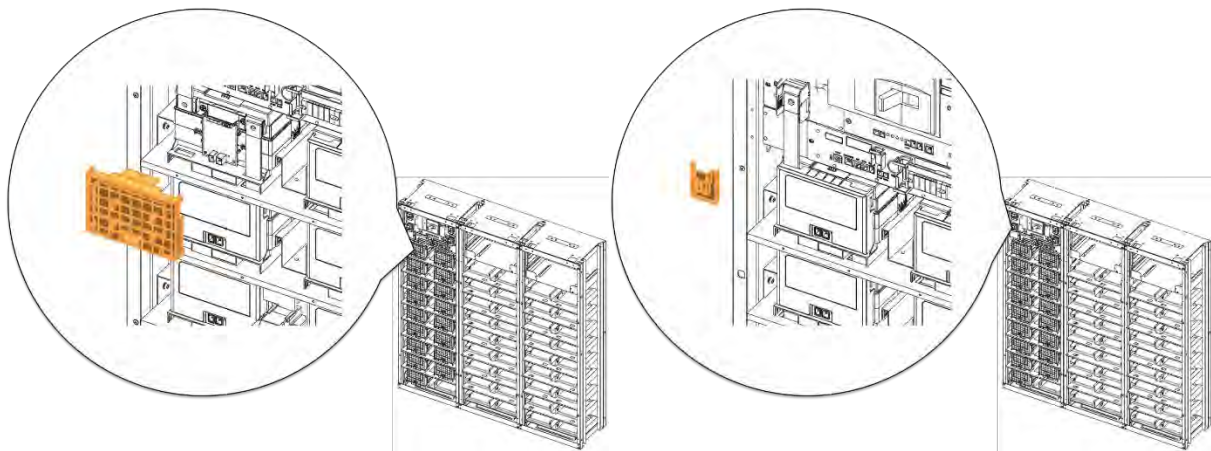



Figure 3-92: Reattach Battery Module #17's Front Cover and SMU B+ Terminal Cover



### 3.10.6 Module and SMU Signal Cable Connection

Connect the signal cables for SMU and Module BMS's for each module.

	<b>NOTICE</b>
	<ul style="list-style-type: none"><li>Use the proper signal cables as specified by the part numbers below.</li></ul>

	<b>WARNING</b>
	<b>Rack BMS / Module BMS Damage</b> Do not insert both ends of the signal cable WIRE ASSY MODULE TO MODULE #1 or WIRE ASSY MODULE TO MODULE #2 into the same Battery Module.

1. Connect the signal cable “WIRE ASSY RACK TO MODULE” between the SMU “MODULE” connector and Module #1 “Right Connector”.

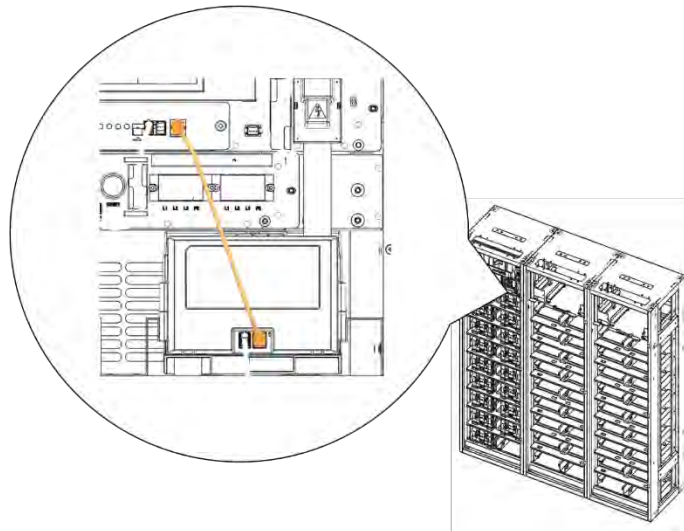

Figure 3-93: SMU to Module #1 Signal Cable

### 3. Installing the Product

2. Connect the signal cable "WIRE ASSY MODULE TO MODULE #1" from Module #1 "Left Connector" to Module #2 "Right Connector."

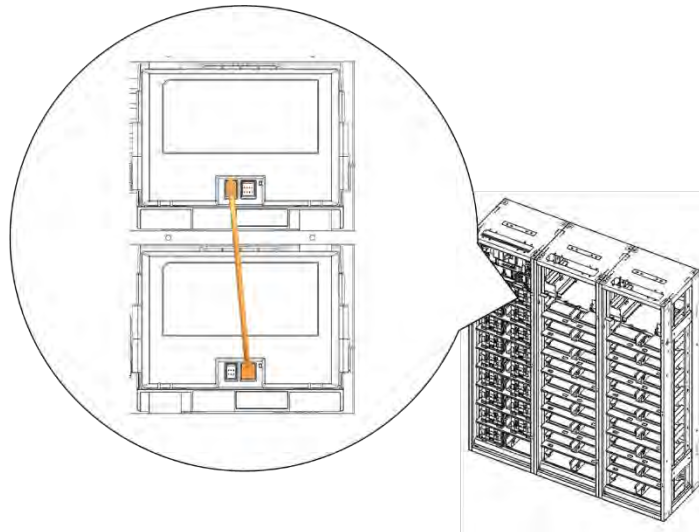

Figure 3-94: Module #1 to Module #2 Signal Cabling

3. Connect the signal cable "WIRE ASSY MODULE TO MODULE #1" from Module #2 "Left Connector" to Module #3 "Right Connector."

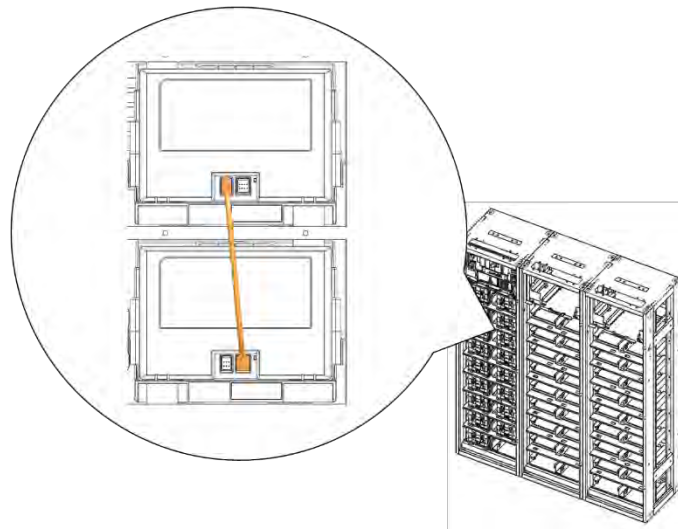

Figure 3-95: Module #2 to Module #3 Signal Cabling

4. Connect the signal cable "WIRE ASSY MODULE TO MODULE #1" from Module #3 "Left Connector" to Module #4 "Right Connector."

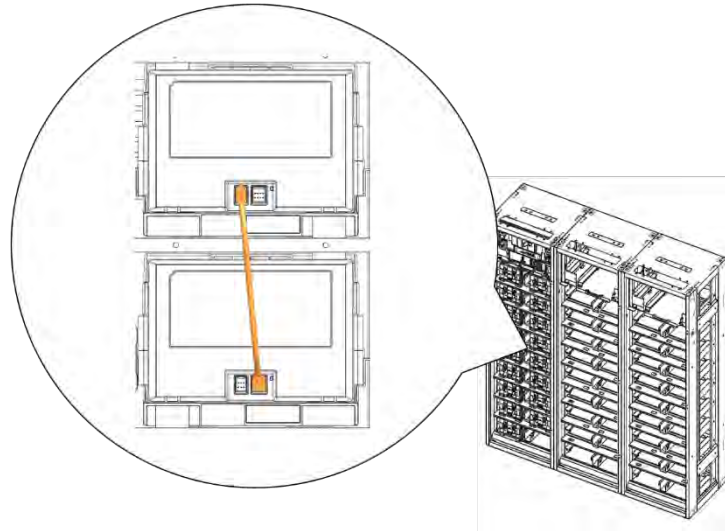

Figure 3-96: Module #3 to Module #4 Signal Cabling

5. Connect the signal cable "WIRE ASSY MODULE TO MODULE #1" from Module #4 "Left Connector" to Module #5 "Right Connector."

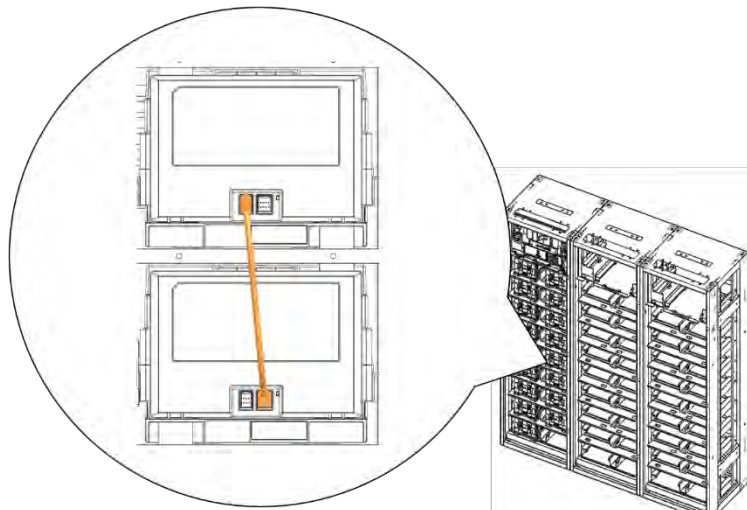

Figure 3-97: Module #4 to Module #5 Signal Cabling

### 3. Installing the Product

6. Connect the signal cable "WIRE ASSY MODULE TO MODULE #1" from Module #5 "Left Connector" to Module #6 "Right Connector".

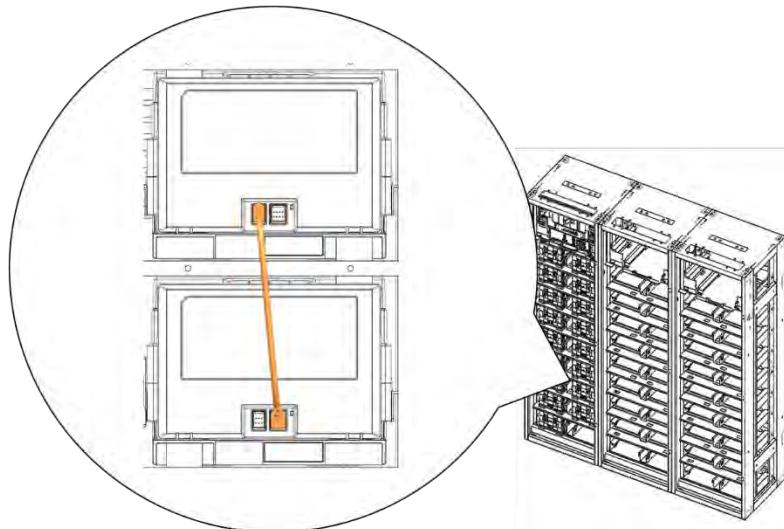

Figure 3-98: Module #5 to Module #6 Signal Cabling

7. Connect the signal cable "WIRE ASSY MODULE TO MODULE #1" from Module #6 "Left Connector" to Module #7 "Right Connector."

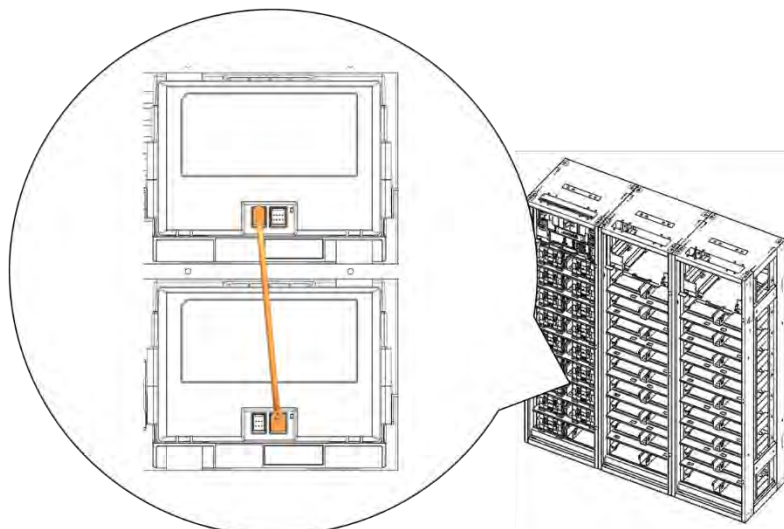

Figure 3-99: Module #6 to Module #7 Signal Cabling

8. Connect the signal cable "WIRE ASSY MODULE TO MODULE #1" from Module #7 "Left connector" to Module #8 "Right connector".

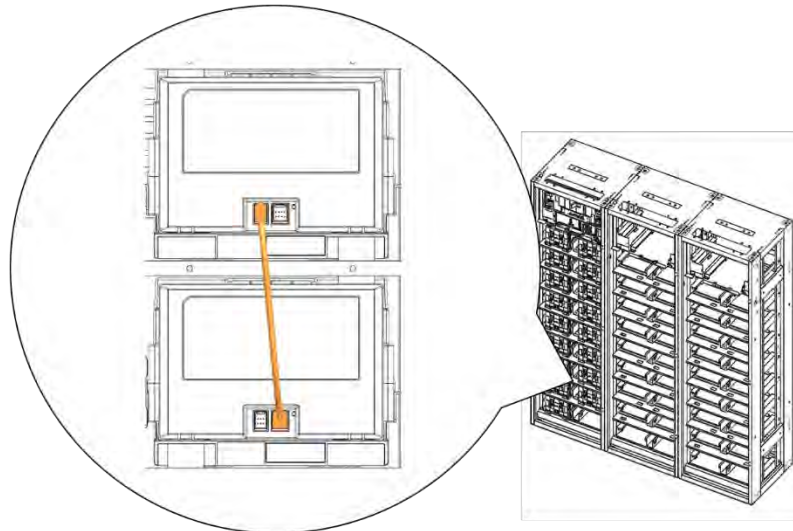

Figure 3-100: Module #7 to Module #8 Signal Cabling

9. Connect the signal cable "WIRE ASSY MODULE TO MODULE #2" from Module #8 "Left Connector" to Module #9 "Right Connector."

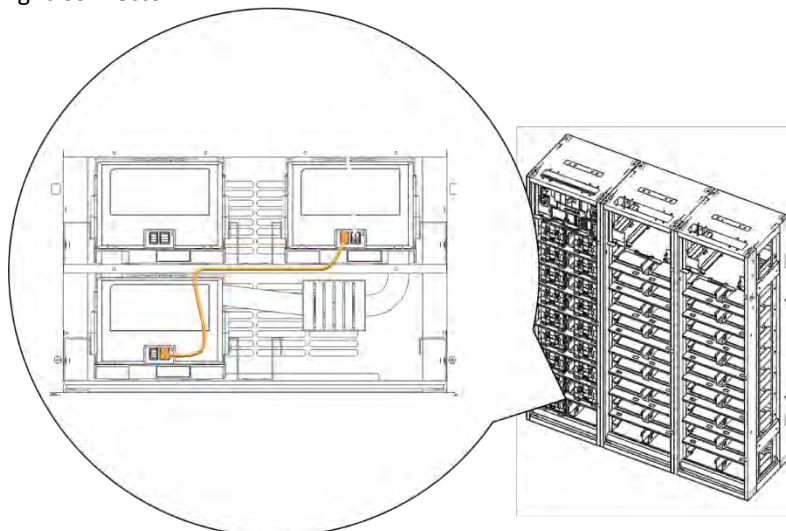

Figure 3-101: Module #8 to Module #9 Signal Cabling

### 3. Installing the Product

10. Connect the signal cable "WIRE ASSY MODULE TO MODULE #1" from Module #9 "Left Connector" to Module #10 "Right Connector."

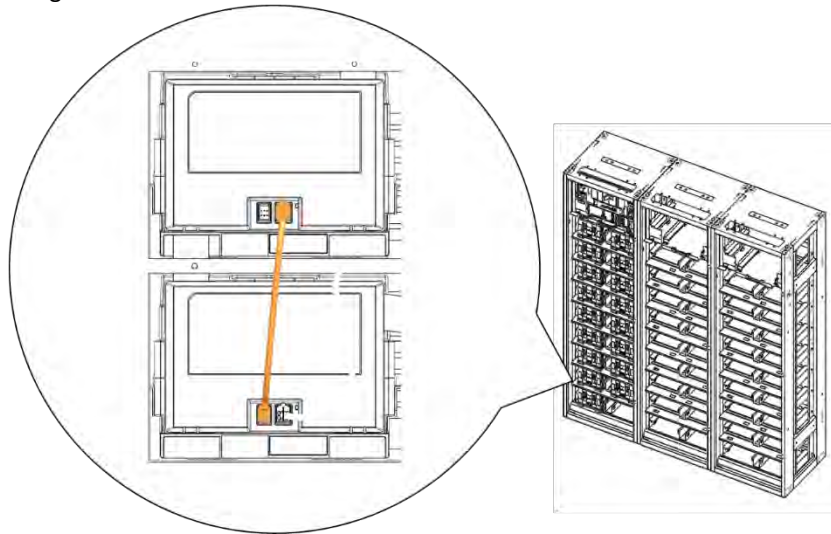

Figure 3-102: Module #9 to Module #10 Signal Cabling

11. Connect the signal cable "WIRE ASSY MODULE TO MODULE #1" from Module #10 "Left Connector" to Module #11 "Right Connector."

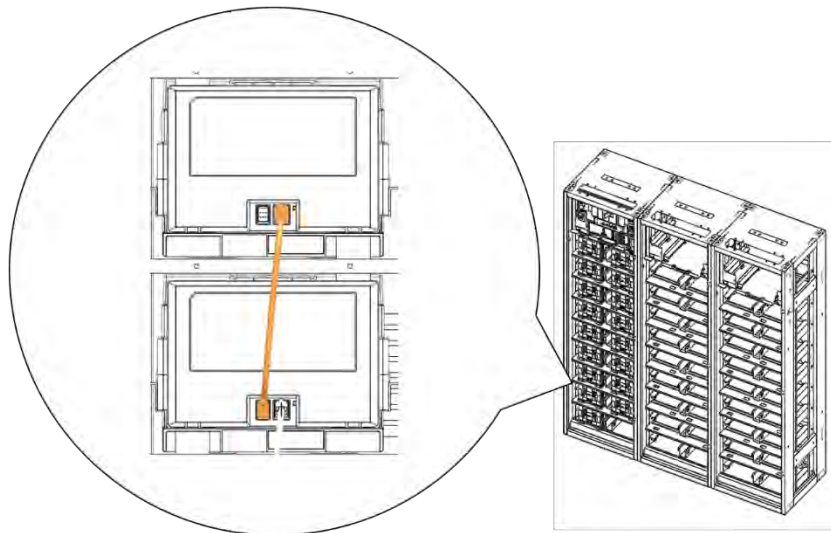

Figure 3-103: Module #10 to Module #11 Signal Cabling

12. Connect the signal cable "WIRE ASSY MODULE TO MODULE #1" from Module #11 "Left Connector" to Module #12 "Right Connector."

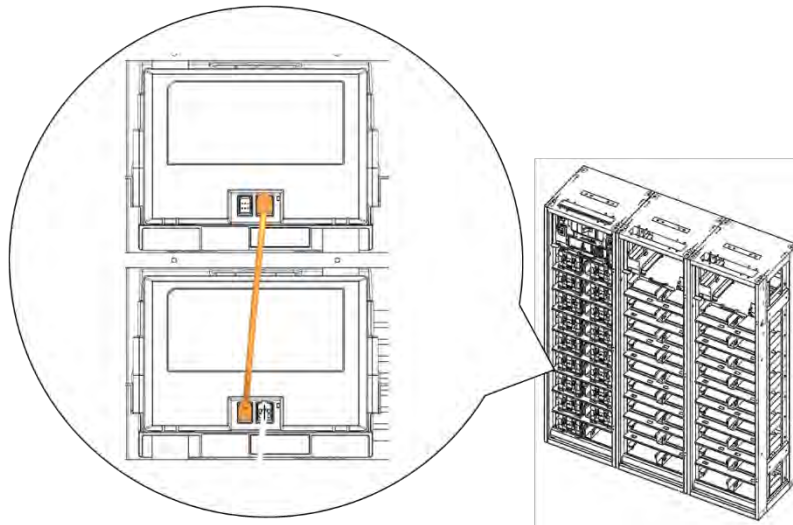

Figure 3-104: Module #11 to Module #12 Signal Cabling

13. Connect the signal cable "WIRE ASSY MODULE TO MODULE #1" from Module #12 "Left Connector" to Module #13 "Right Connector."

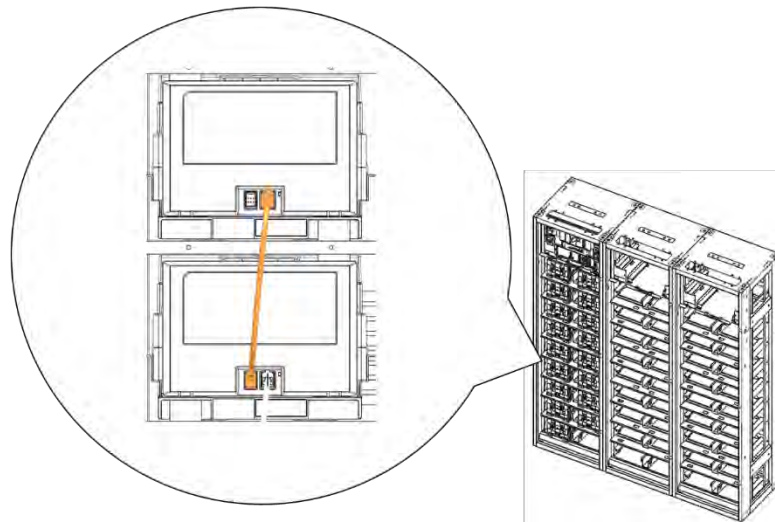

Figure 3-105: Module #12 to Module #13 Signal Cabling

### 3. Installing the Product

14. Connect the signal cable "WIRE ASSY MODULE TO MODULE #1" from Module #13 "Left Connector" to Module #14 "Right Connector."

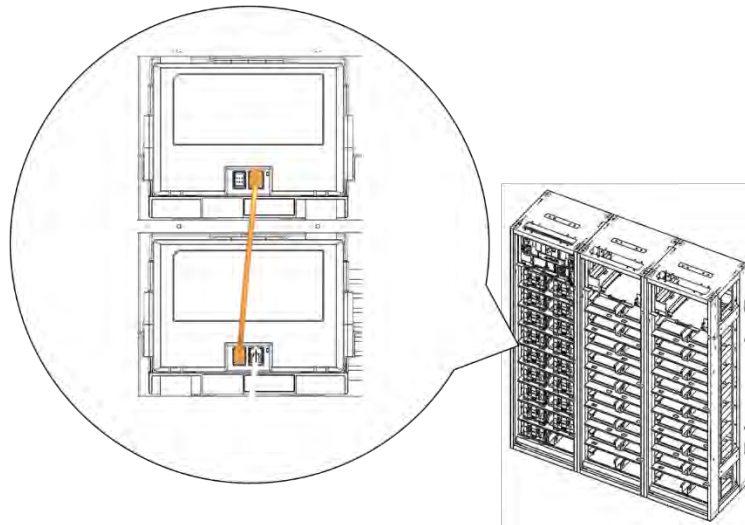

Figure 3-106: Module #13 to Module #14 Signal Cabling

15. Connect the signal cable "WIRE ASSY MODULE TO MODULE #1" from Module #14 "Left Connector" to Module #15 "Right Connector."

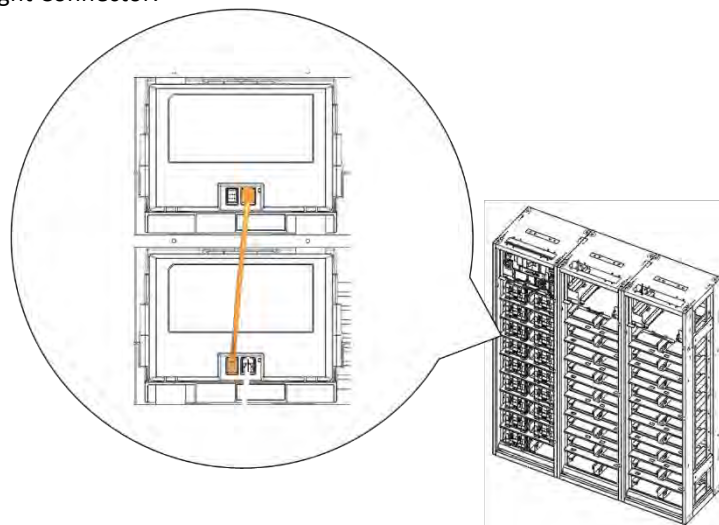

Figure 3-107: Module #14 to Module #15 Signal Cabling



16. Connect the signal cable "WIRE ASSY MODULE TO MODULE #1" from Module #15 "Left Connector" to Module #16 "Right Connector."

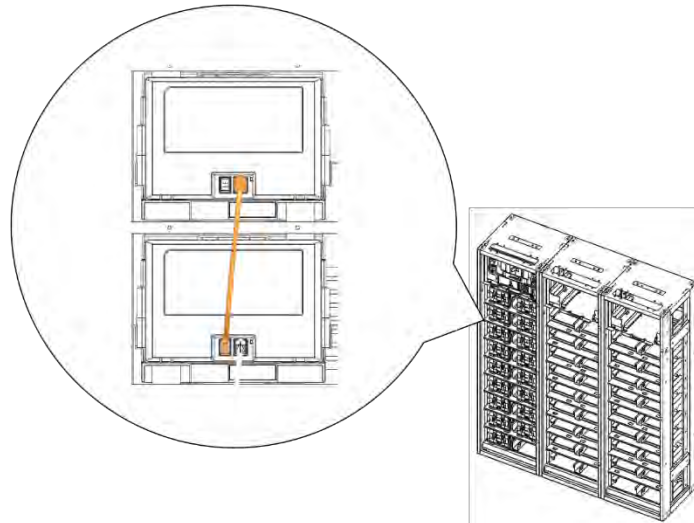

Figure 3-108: Module #15 to Module #16 Signal Cabling

17. Connect the signal cable "WIRE ASSY MODULE TO MODULE #1" from Module #16 "Left Connector" to Module #17 "Right Connector".  
No connection to Module #17 "Left Connector" is needed.

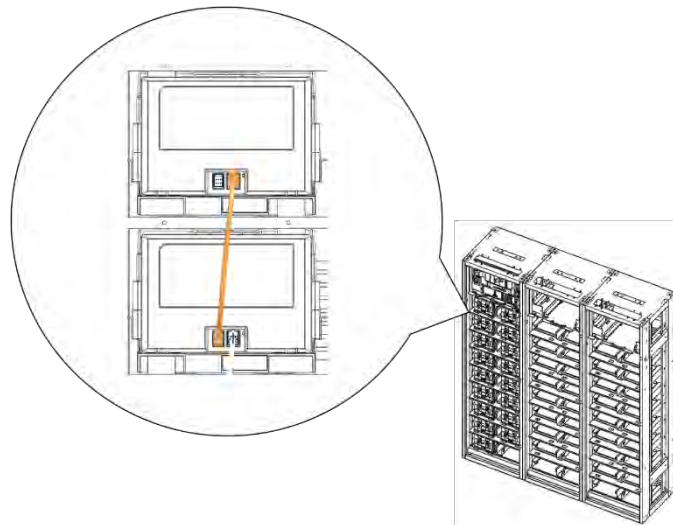



Figure 3-109: Module #16 to Module #17 Signal Cabling

### 3. Installing the Product

18. For a multiple rack system, connect the signal cables “WIRE ASSY RACK TO RACK #2” between each rack’s SMU. Push the pre-punched hole to pass the cable through a circular hole in the side of the rack frame and through the opening above Module #1 and Module #16.

	<b>NOTICE</b>
<ul style="list-style-type: none"> <li>▪ See the examples for correct signal cable wire connections for both left and right rack alignments.</li> </ul>	

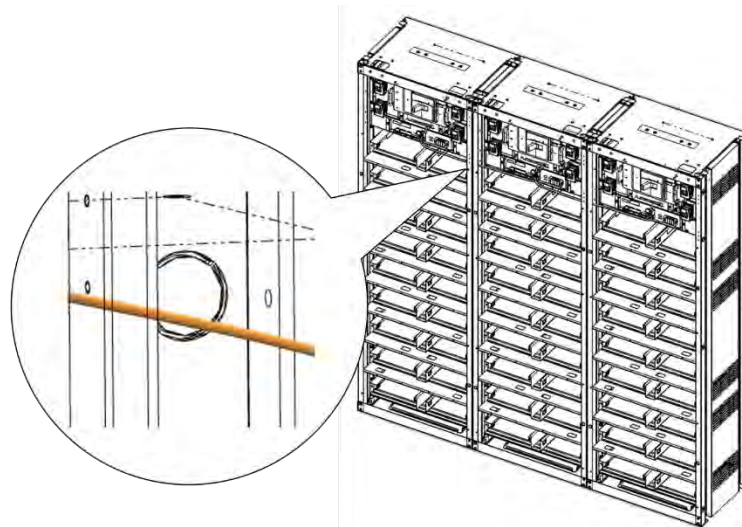

Figure 3-110: Pre-Punched Hole for Signal Cable

Signal Cabling Examples of Left Alignment of Trays (System BMS on the left)



Figure 3-111: Signal Cabling Examples of Left Alignment of SMU

19. Turn the termination resistor switch on for the last SMU in the CANbus loop.

### 3. Installing the Product

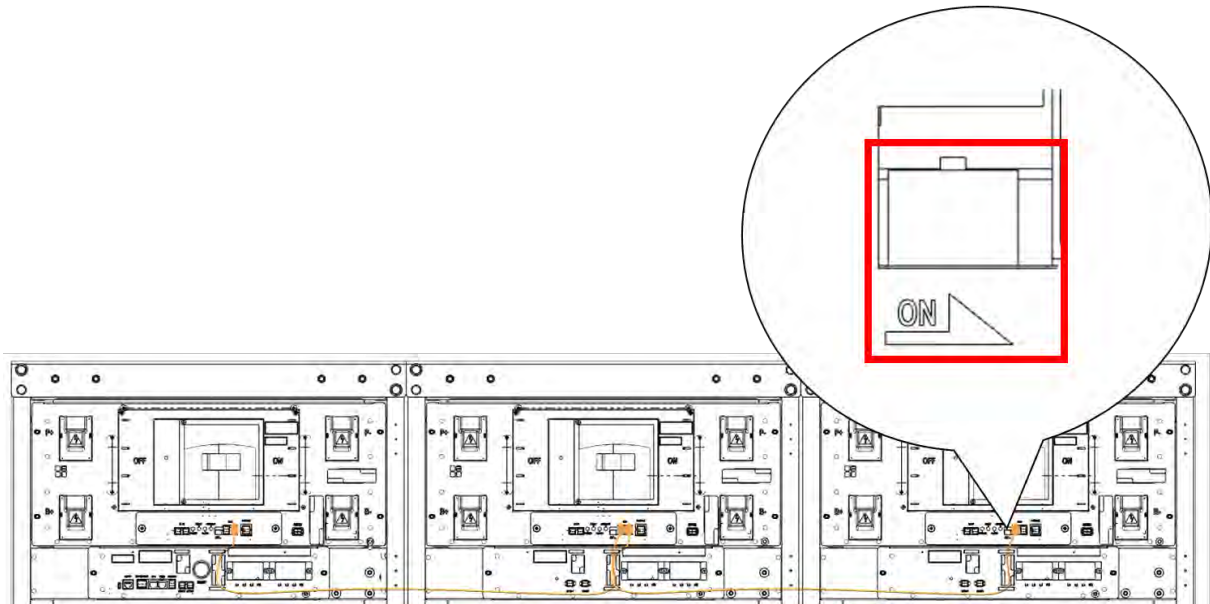

Figure 3-112: Termination Resistor Setting for Last SMU



**NOTICE**

- Factory-provided cables are adequate for systems with Rack Frames bolted together. Different configurations may require cable length modification.

### 3.10.7 SMPS Assembly and SMU Power Cable Connection

Connect the SMU DC power cables.

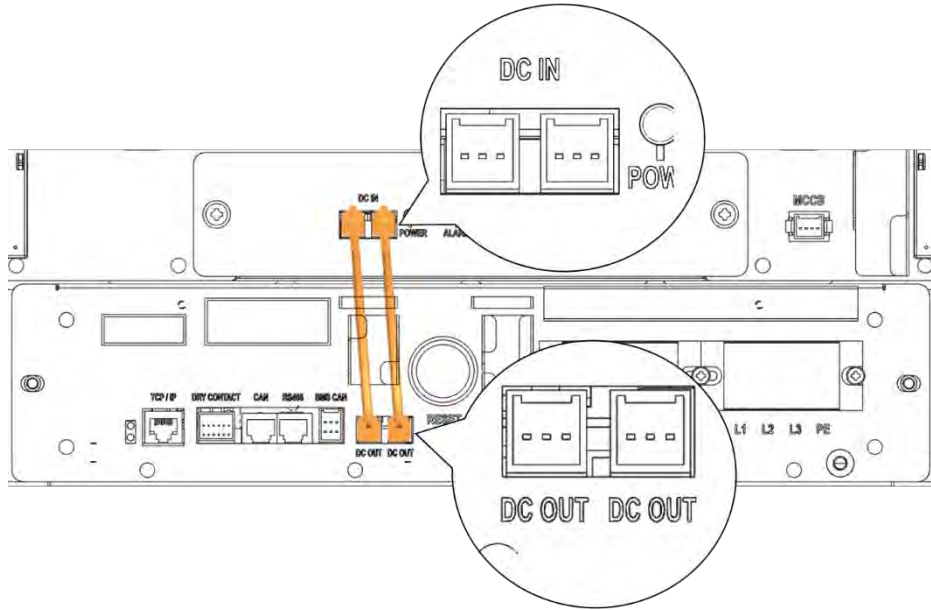

Figure 3-113: DC Power Cables from SMPS Assembly 3 Phase Type A to SMU

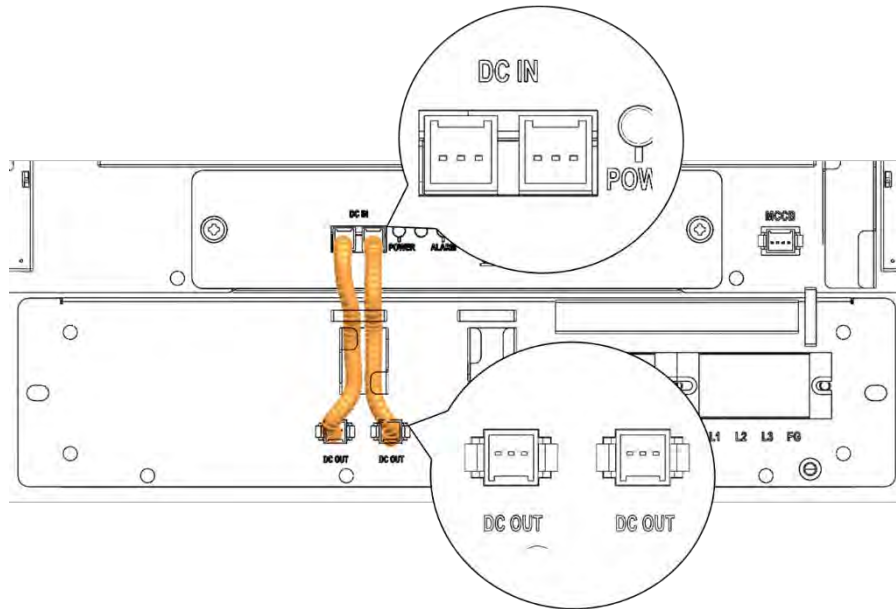

Figure 3-114: DC Power Cables from SMPS Assembly 3 Phase Type B to SMU

### 3. Installing the Product

#### 3.10.8 SMPS Assembly and SMU Signal Cable Connection

The following steps are only for an SMPS Assembly Type A.

1. Connect the signal cable from the SMPS Assembly to SMU “WIRE ASSY RACK TO SYSTEM.”

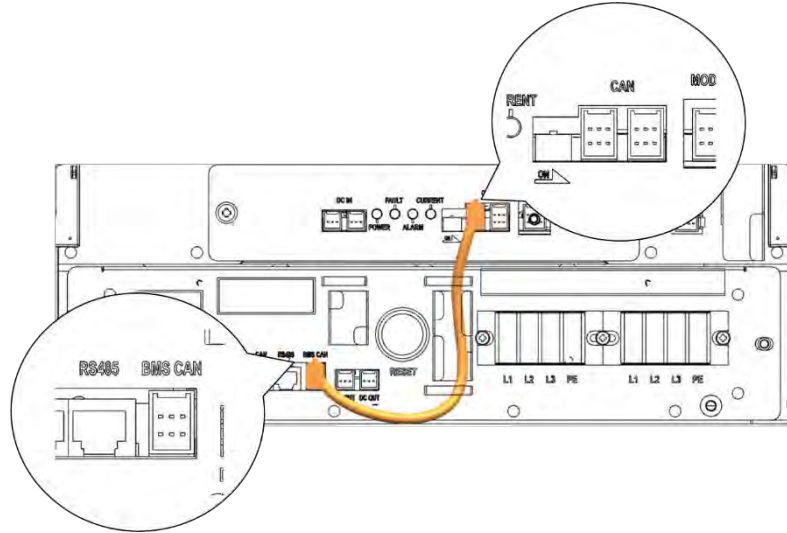

Figure 3-115: CAN Signal Cable Connection from SMPS Assembly 3 Phase Type A to SMU

2. Connect the MODBUS TCP/IP Cable<sup>4</sup> to the SMPS Assembly Type A.

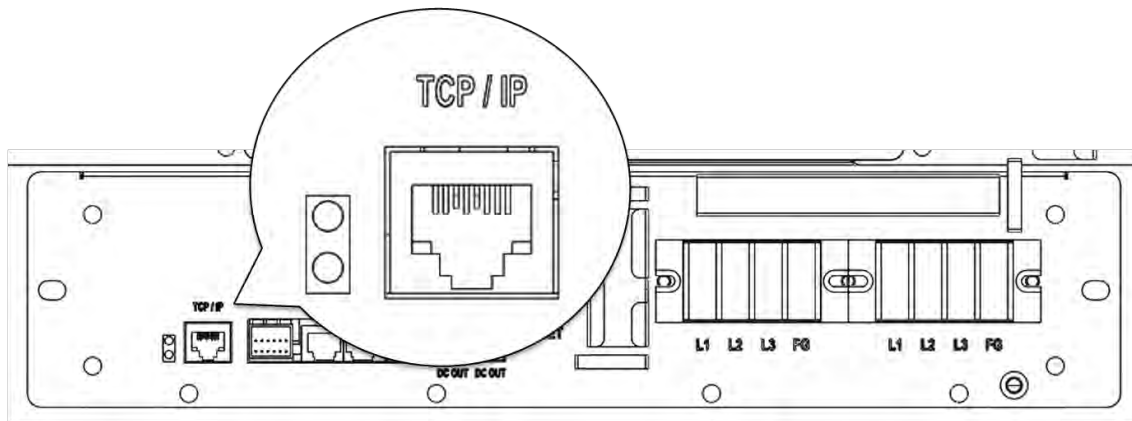

Figure 3-116: TCP/IP Cable Connection to SMPS Assembly

3. Connect the Dry Contact Cable to SMPS Assembly Type A

<sup>4</sup> Not factory-provided. Must be provided by the installer or customer.

3. Installing the Product

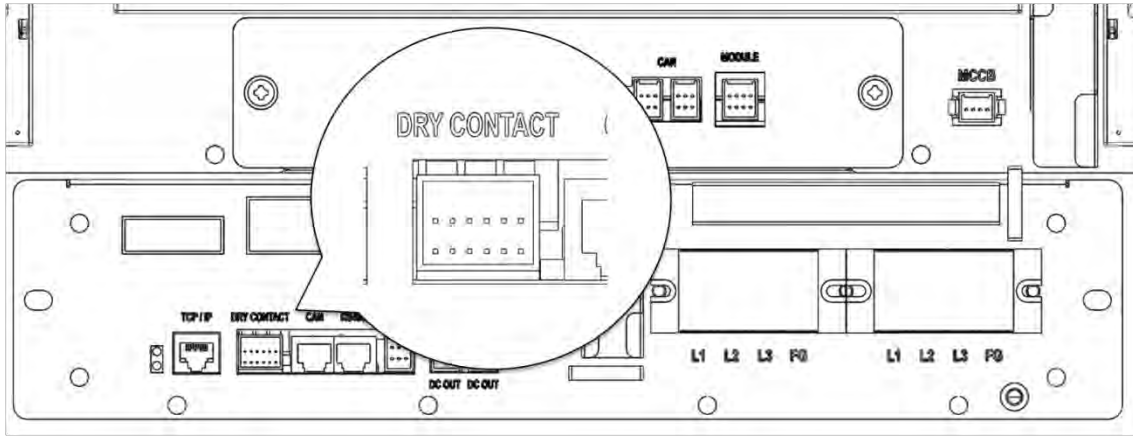

Figure 3-117: Dry Contact Cable Connection to SMPS Assembly

4. Optional: Connect the SMU MCCB Cable.

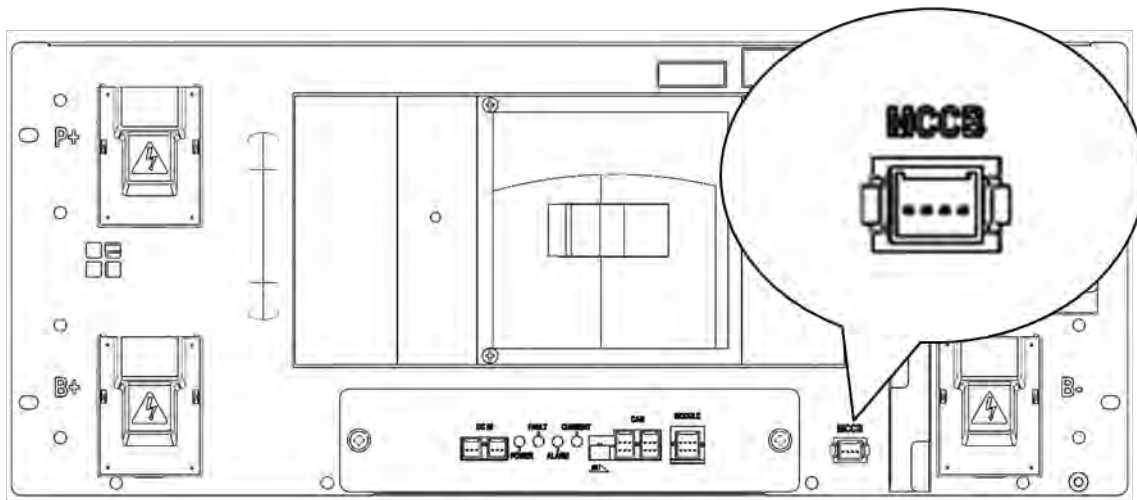

Figure 3-118: MCCB Extra Auxiliary Connection

### 3. Installing the Product

#### 3.10.9 SMPS Assembly AC Input Connection

1. Remove the protective covers from the AC input terminals.

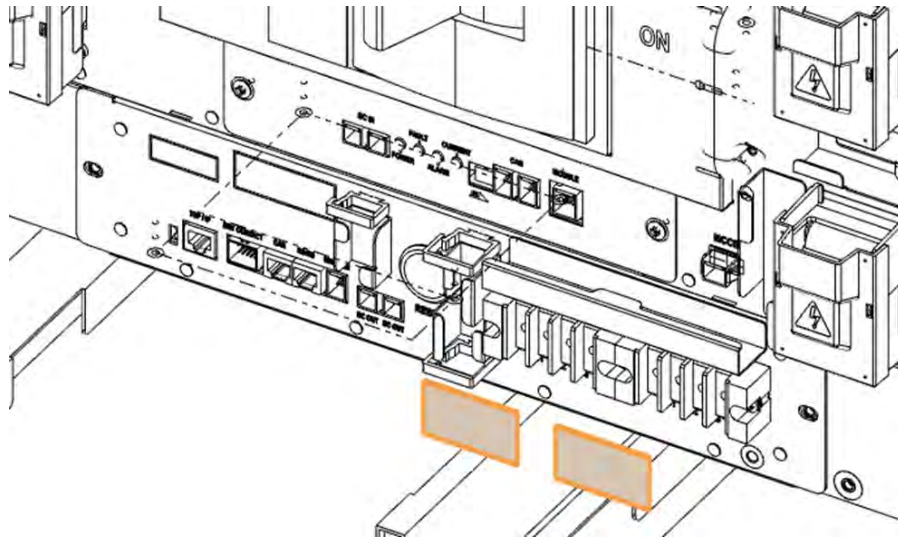

Figure 3-119: AC Input Terminals of SMPS Assembly 3 Phase Type A

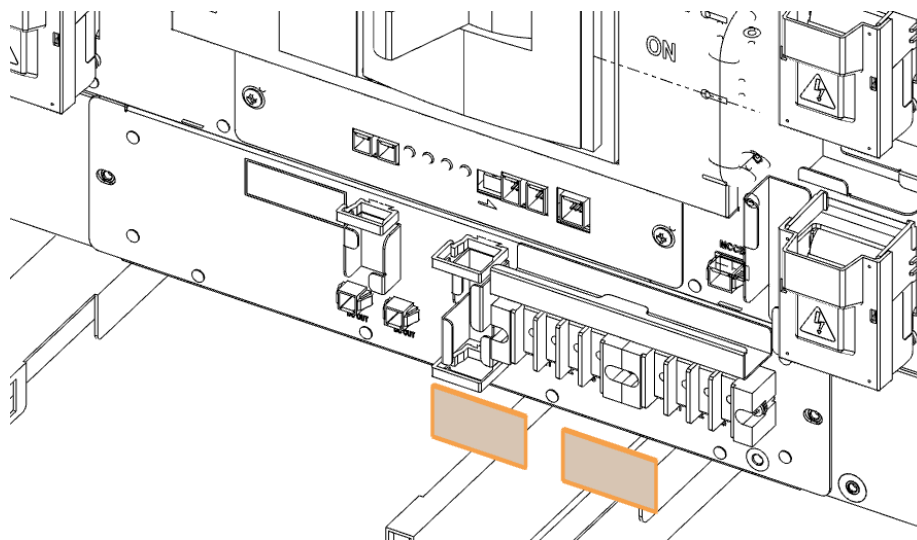

Figure 3-120: AC Input Terminals of SMPS Assembly 3 Phase Type B



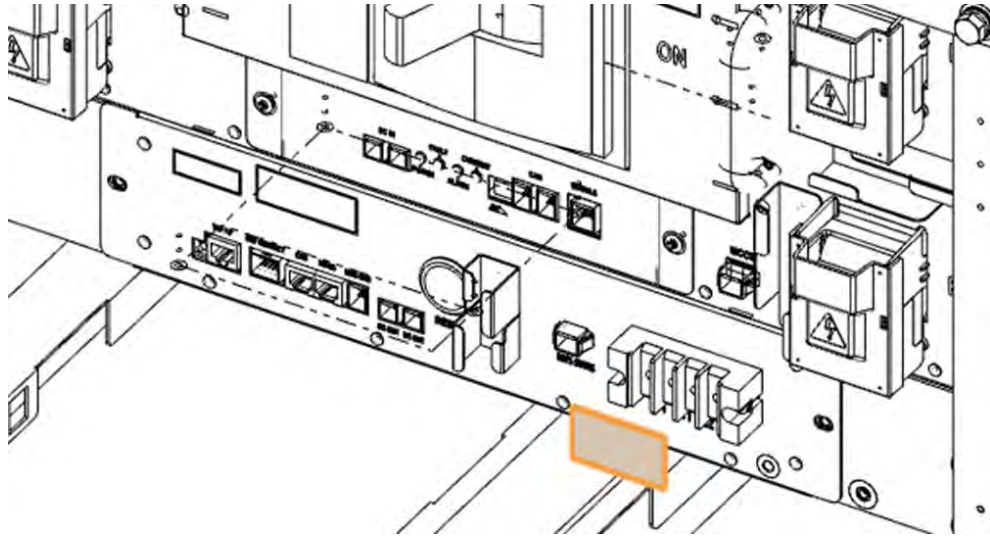

Figure 3-121: AC Input Terminals of SMPS Assembly 1 Phase Type A

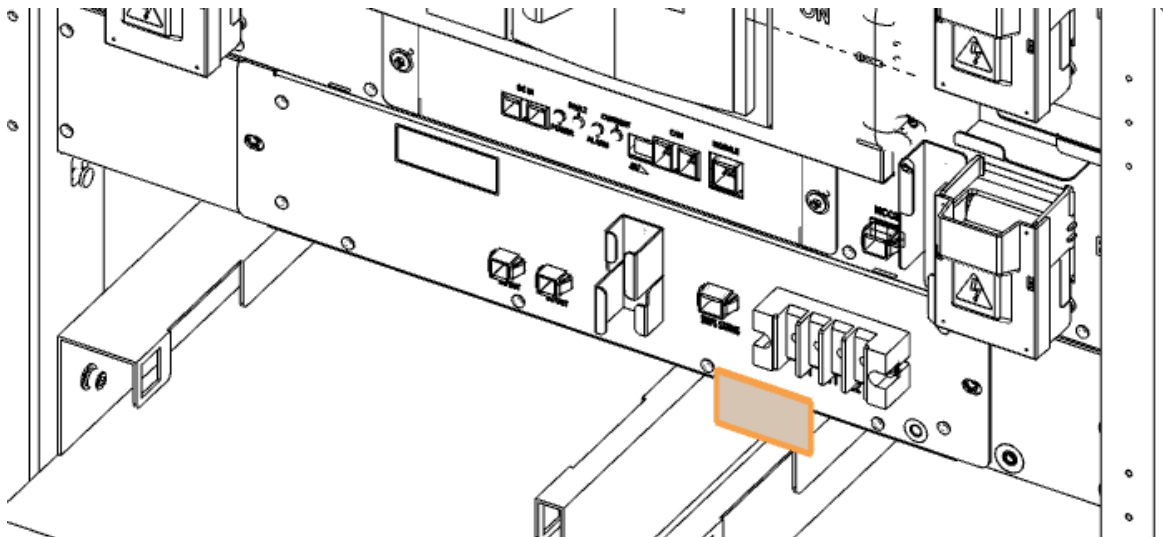

Figure 3-122: AC Input Terminals of SMPS Assembly 1 Phase Type B

### 3. Installing the Product

2. Connect each AC input in the SMPS Assembly. Make sure the AC cables are not energized.<sup>5</sup>

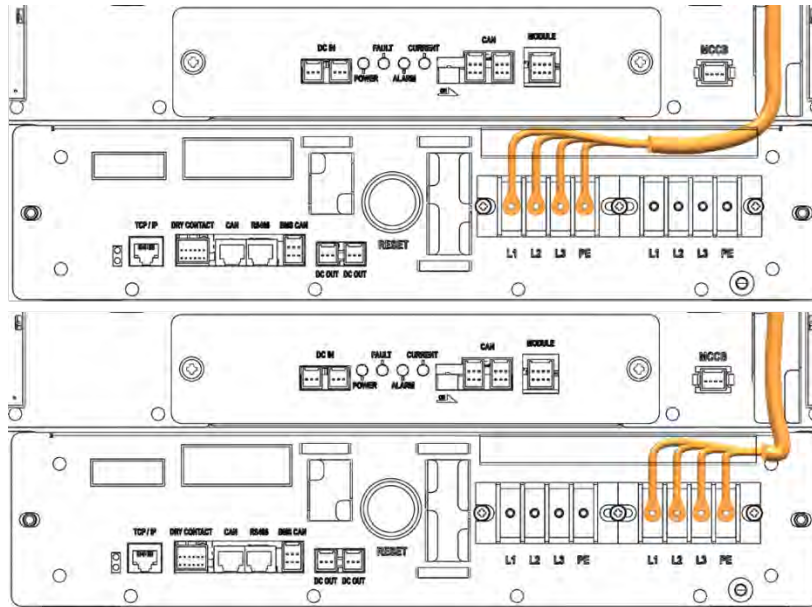

Figure 3-123: SMPS Assembly 3 Phase Type A - AC Input Terminals with Cables Attached

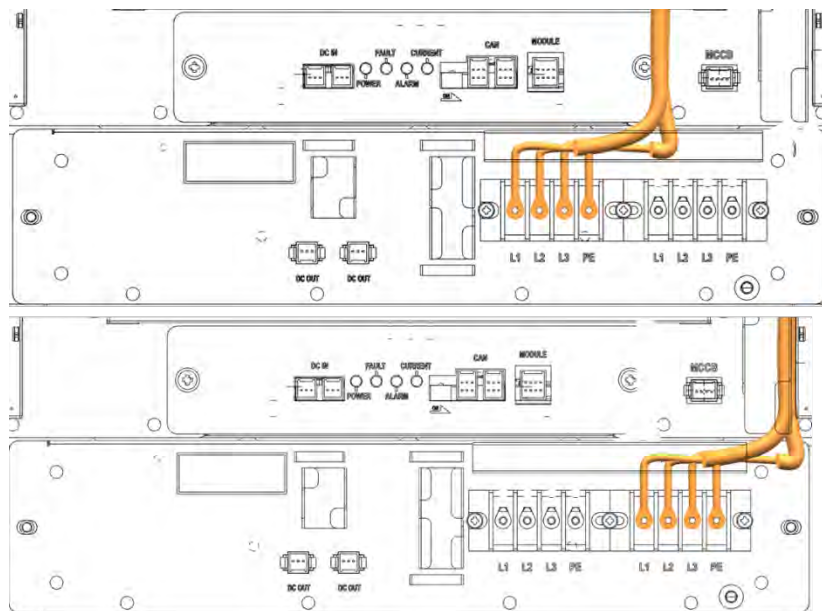

Figure 3-124: SMPS Assembly 3 Phase Type B - AC Input Terminals with Cables Attached

<sup>5</sup> AC Cables are not factory-provided. They must be provided by the installer or customer.

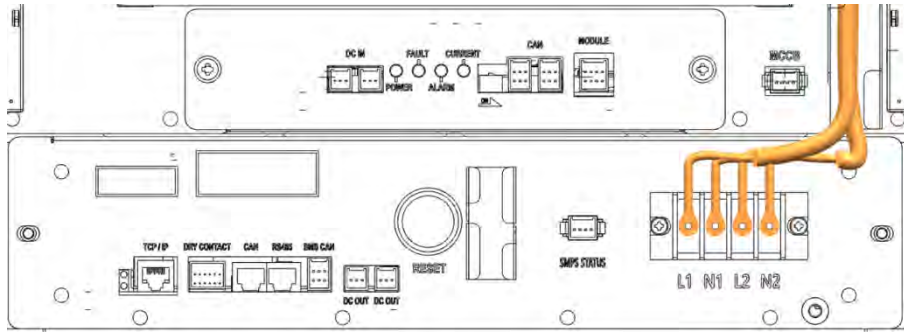

Figure 3-125: SMPS Assembly 1 Phase Type A - AC Input Terminals with Cables Attached

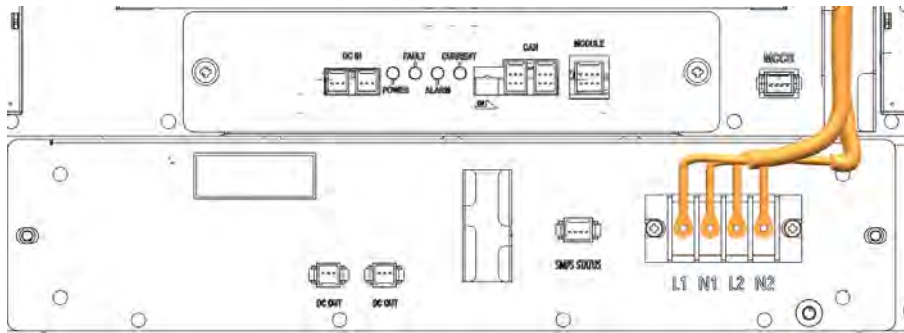

Figure 3-126: SMPS Assembly 1 Phase Type B - AC Input Terminals with Cables Attached

3. Reattach the protective covers to the AC input.

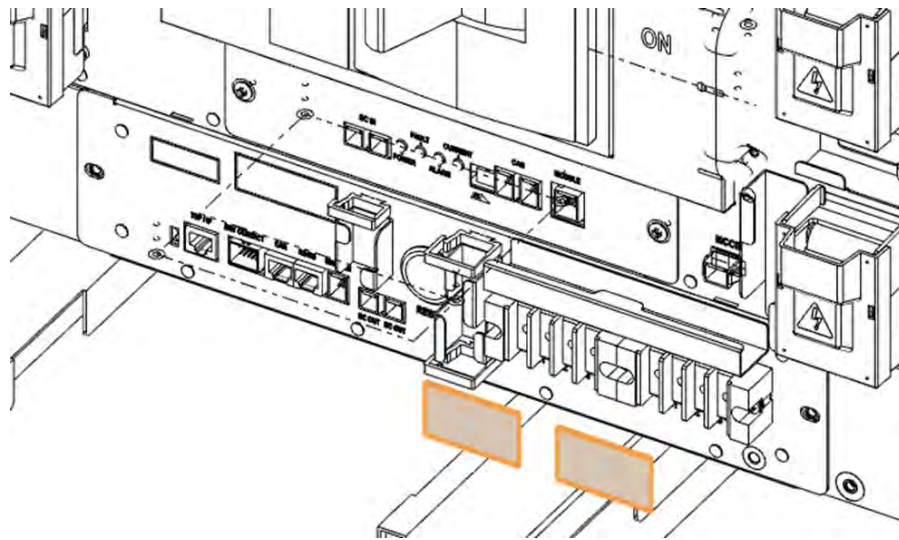

Figure 3-127: AC Input Terminals of SMPS Assembly 3 Phase Type A

### 3. Installing the Product

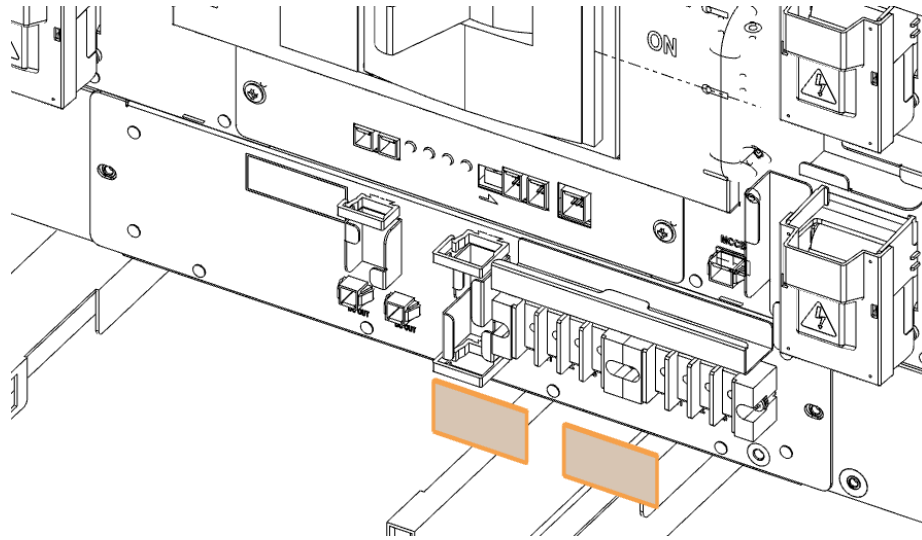

Figure 3-128: AC Input Terminals of SMPS Assembly 3 Phase Type B

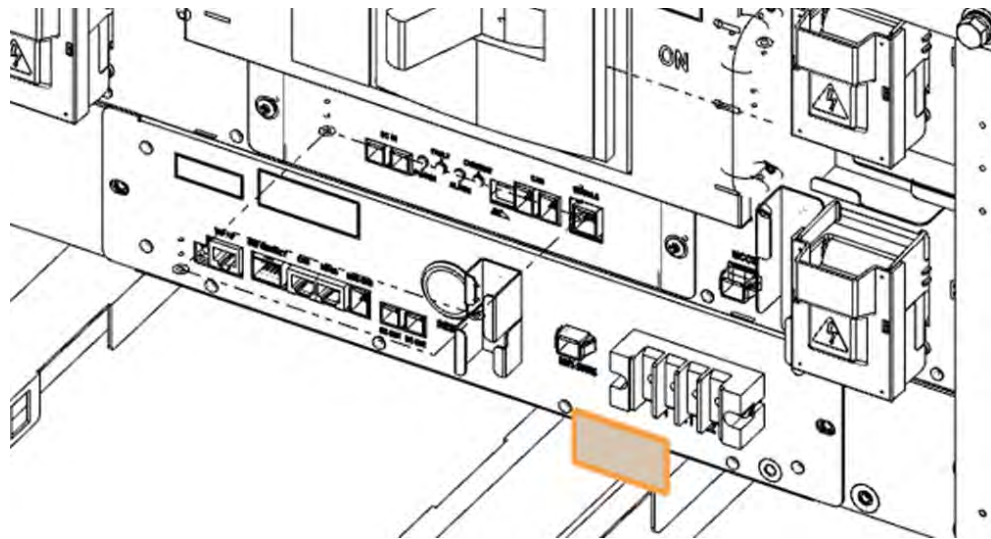

Figure 3-129: AC Input Terminals of SMPS Assembly 1 Phase Type A

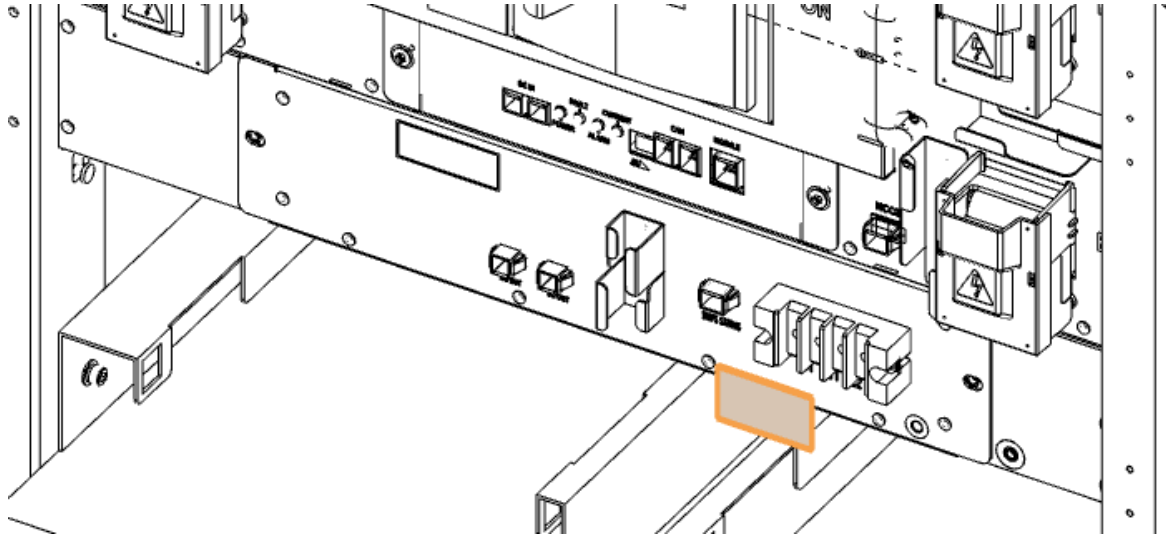

Figure 3-130: AC Input Terminals of SMPS Assembly 1 Phase Type B

3. Installing the Product

**3.10.10 DC Link Cable Connection**

1. Connect the ground cables.

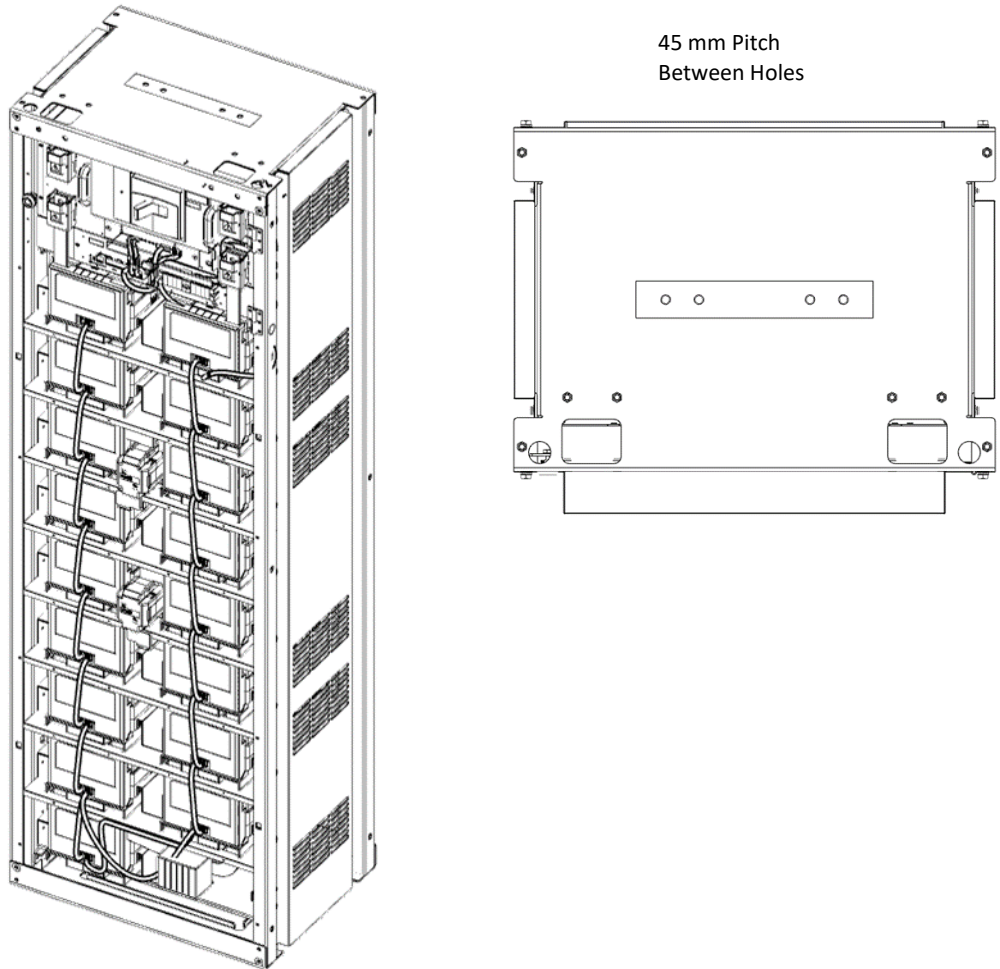





Figure 3-131: Grounding Points (2 EA)

	<b>NOTICE</b>
	<ul style="list-style-type: none"> <li>▪ Connect the rack ground wire with an M12 screw. Rack ground screws and cables are not factory-provided and must be provided by the installer or customer.</li> <li>▪ The fastening torque should be 30Nm (300kgf·cm).</li> </ul>

## 2. Connect the DC link high-voltage terminals from the UPS.

	<b>CAUTION</b>
	<ul style="list-style-type: none"> <li>▪ Verify with a voltmeter that no power is present on the system. Disconnect all input power supplies. Use lock out/tag out procedures to secure the UPS and battery system before beginning this step.</li> <li>▪ In this step, the battery and UPS are isolated by the SMU because the circuit breaker in the SMU is opened.</li> </ul>

	<b>NOTICE</b>
	<ul style="list-style-type: none"> <li>▪ Connect the high-voltage terminals using an M12 bolt.</li> <li>▪ The fastening torque should be 30 Nm (300 kgf/cm).</li> </ul>

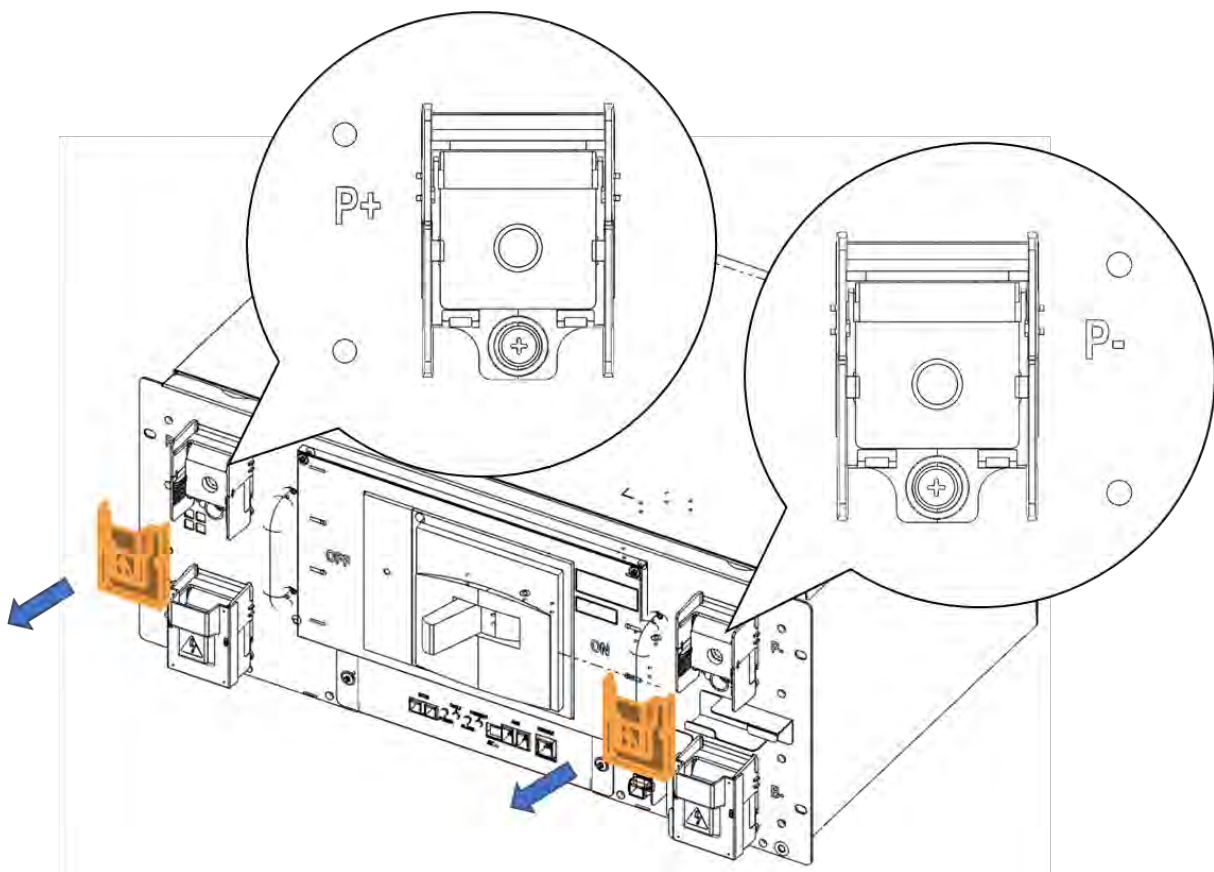
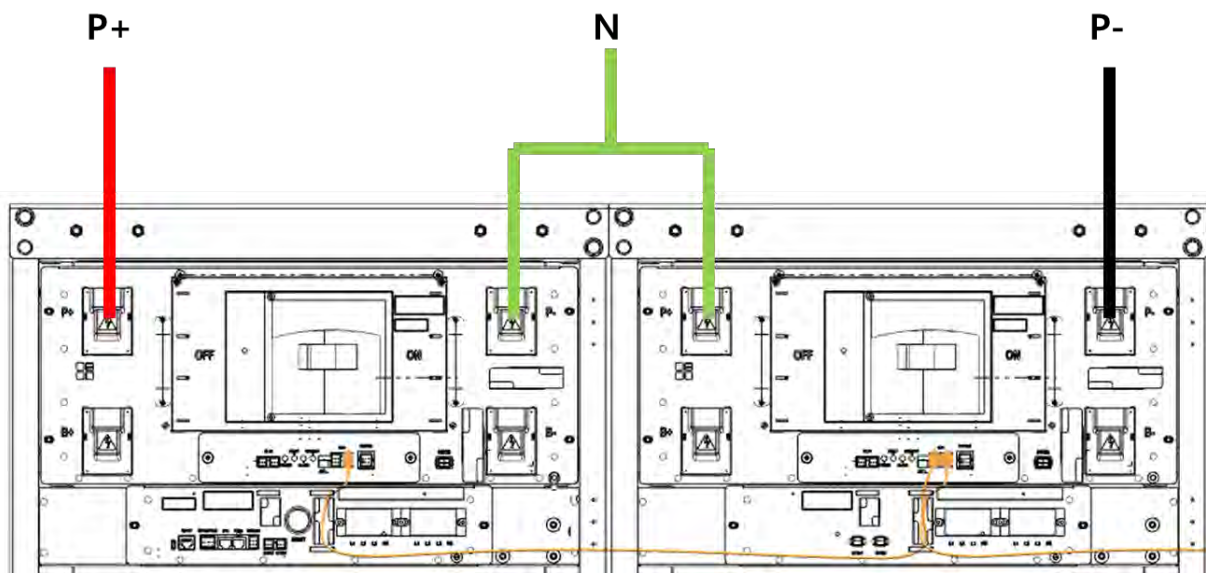

Figure 3-132: Connecting the DC Link High Current Terminals

## 3. Special case: if connecting the battery system in three-wire system, connect two racks to the three-wire DC bus connection according to the diagram below. System BMS must be configured to operate correctly with this connection.

### 3. Installing the Product

---



After installation is complete, check the following:

- Bolt fastening condition
- Screw fastening torque by sampling
- High-voltage cable connection
- Module connections
- SMU connections



### **3.10.11 AC Input Commissioning**

When the installation of the battery system is complete, SMPS Assembly's AC inputs must be powered to turn the BMS on.

### 3. Installing the Product

---

#### 3.10.12 BMS Configuration

	<p><b>NOTICE</b></p> <ul style="list-style-type: none"><li>▪ It is recommended that the configuration of the Rack BMS and System BMS be done by experienced service personnel. Incorrect configuration of the Rack BMS and System BMS will cause communication failure.</li></ul>
---	---

This section has been removed from the customer facing copy of the installation manual.

#### 3.10.13 Communication Check

This section has been removed from the customer facing copy of the installation manual.

### 3.10.14 Reinstall the Front Door

1. Reinstall the front door to cover the battery rack and prevent further access to high voltage parts of the SMU and SMPS Assembly.
2. Align the hinges on the rack frame and front door and slide the door down.

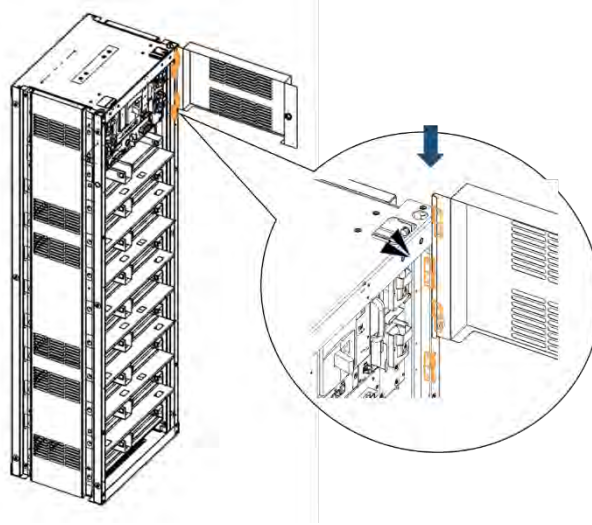

Figure 3-133: Reattaching the Front Door

3. Reattach the earth cable from the rack frame to the front door.

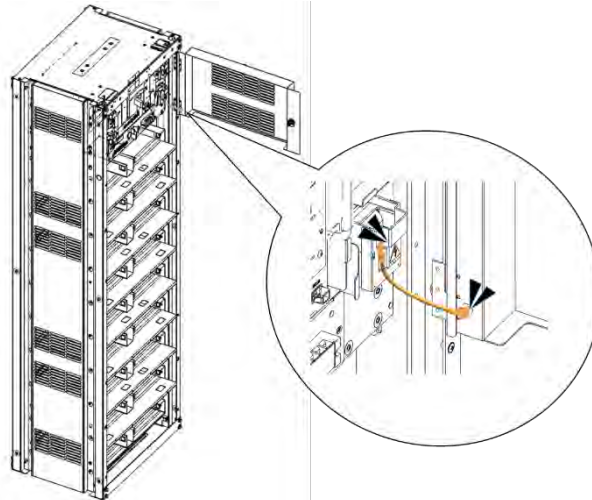

Figure 3-134: Reattaching the earth cable.

4. Close and lock the front door using the provided key. Do not misplace the key.

### 3. Installing the Product

#### 3.10.15 Reinstall the Front Panel

1. Reinstall the front panel to cover the battery rack and prevent further access to high voltage parts of the battery modules.
2. Locate the hooks that hold the front panel to the slots in the rack frame and insert the front panel to the rack frame. Make sure all the hooks are inserted to the slot and the panel is flush with the rack frame before screwing.

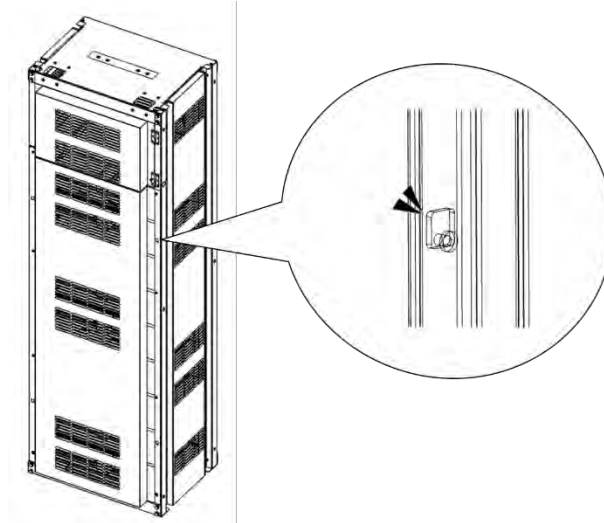

Figure 3-135: Front panel hooks (four)

3. Screw in the front panel using the provided M5 screws for each front panel. Fasten the screws using torque of 5.1–6.1 Nm (50–60 kgf/cm)

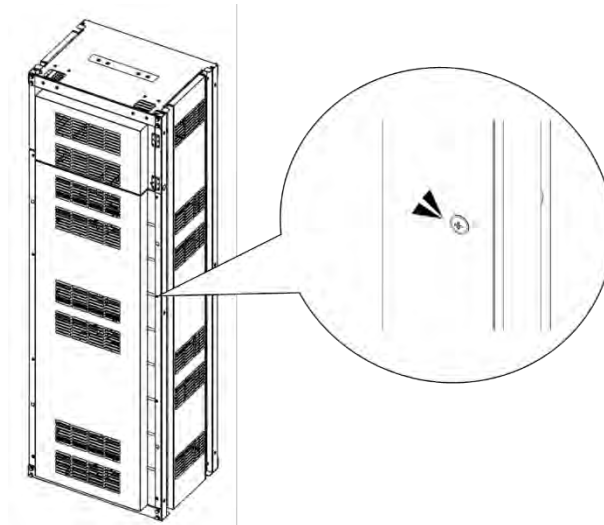

Figure 3-136: Front panel screws (eight)

### 3.10.16 Switching on the MCCB

After powering on the battery system's SMPS Assembly and SMU, and configuring the System BMS and the Rack BMS according to the installation, check the indicator LED to determine whether the system status is normal. Refer to the "Product Specification" and "Operation and Maintenance Manual" for information on the indicator LED.



#### CAUTION

- Follow the instruction and guidelines for the UPS on connecting the battery to the UPS before switching on the MCCB.

The MCCB in the SMU should be in the "TRIP" position during installation.

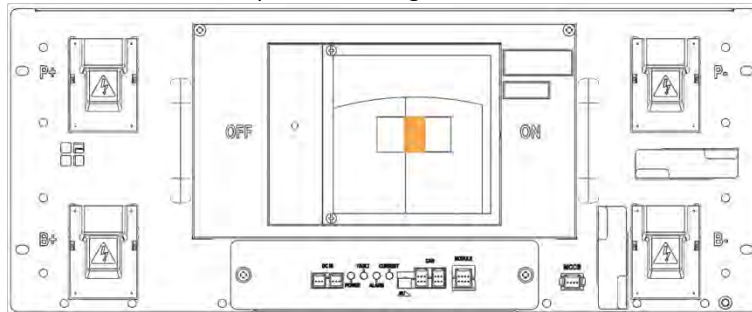

Figure 3-137: MCCB Handle in Trip Position

Shift the handle of the MCCB to "OFF."

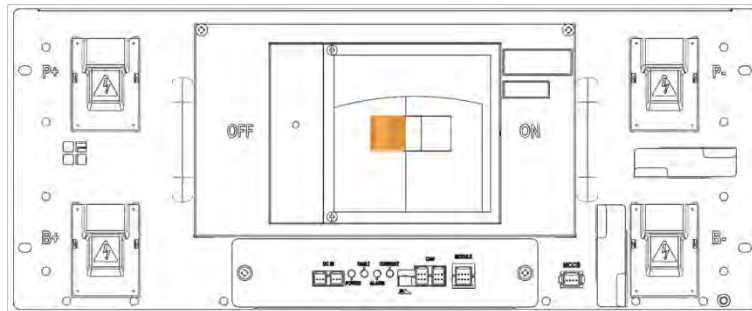

Figure 3-138: MCCB Handle in Off Position

Then shift the handle to "ON" to connect the battery system to the UPS DC link.

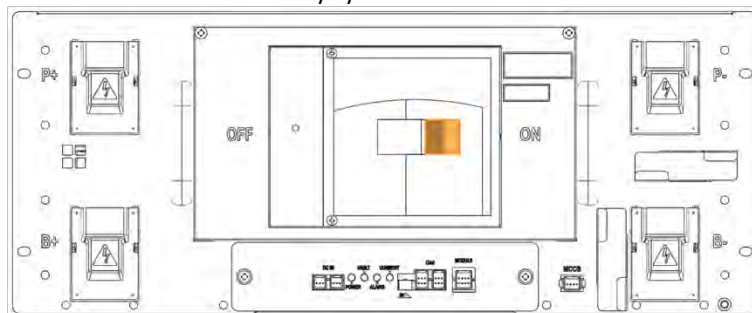

Figure 3-139: MCCB Handle in On Position



Memo

Lined area for writing the memo content, consisting of 25 horizontal lines.

---

Memo

---

Multiple horizontal dotted lines for writing content.

---



[www.SamsungSDI.com](http://www.SamsungSDI.com)