



Liebert® GXT5 Lithium-Ion UPS

Installer/User Guide

200-240 V Input, 200-240 V Output, L1, L2/N, G (GV)

The information contained in this document is subject to change without notice and may not be suitable for all applications. While every precaution has been taken to ensure the accuracy and completeness of this document, Vertiv assumes no responsibility and disclaims all liability for damages result from use of this information or for any errors or omissions.

Refer to local regulations and building codes relating to the application, installation, and operation of this product. The consulting engineer, installer, and/or end user is responsible for compliance with all applicable laws and regulations relation to the application, installation, and operation of this product.

The products covered by this instruction manual are manufactured and/or sold by Vertiv. This document is the property of Vertiv and contains confidential and proprietary information owned by Vertiv. Any copying, use, or disclosure of it without the written permission of Vertiv is strictly prohibited.

Names of companies and products are trademarks or registered trademarks of the respective companies. Any questions regarding usage of trademark names should be directed to the original manufacturer.

Technical Support Site

If you encounter any installation or operational issues with your product, check the pertinent section of this manual to see if the issue can be resolved by following outlined procedures.

Visit <https://www.vertiv.com/en-us/support/> for additional assistance.

TABLE OF CONTENTS

1 Important Safety Instructions	1
2 Product Description	3
2.1 UPS Features and Available Models	3
2.2 Front Panels	4
2.3 Rear Panels	5
2.4 Maintenance Bypass Cabinet	7
2.5 External Battery Cabinets	7
2.6 Major Internal Components and Operating Principle	8
2.7 UPS States and Operating Modes	9
2.7.1 Normal Mode	9
2.7.2 Bypass Mode	9
2.7.3 Battery Mode	9
2.7.4 Frequency Converter Mode	10
2.7.5 ECO Mode	10
3 Installation	11
3.1 Unpacking and Inspection	11
3.2 Pre-Installation Preparation	11
3.2.1 Installation Clearances	11
3.3 Installing the UPS and External Battery Cabinet	12
3.4 Hardwired Input/Output Connections	12
3.4.1 Branch Circuit Breaker	12
3.4.2 Terminal Block Connections	15
3.4.3 Connecting to Terminal Blocks on 5 kVA, 6 kVA, 8 kVA, and 10 kVA Models	15
3.4.4 Connecting the EBCs and Setting Up the ADDRESS DIP Switch	15
3.5 Communication Connections	17
3.5.1 Connecting Vertiv™ Liebert® IntelliSlot™ Communication	17
3.5.2 Connecting to the Dry Contact REPO Port	17
3.5.3 Connecting a Remote Emergency Power Off (REPO) Switch	19
3.5.4 Connecting a USB Cable	20
3.5.5 Connecting CLI Communication Cables	20
4 UPS Management Software	21
5 Operating the UPS	23
5.1 Silencing the Audible Alarm	23
5.2 Starting Up the UPS	23
5.3 Transferring to Battery Mode	24
5.4 Transferring from Normal to Bypass Mode	24
5.5 Transferring from Bypass to Normal Mode	24

- 5.6 Shutting Down the UPS Completely24
- 5.7 Remote Emergency Power Off (REPO)24
- 6 Operation and Display Panel25**
- 6.1 LED Indicators26
- 6.2 LCD Menu and Screens27
 - 6.2.1 Startup and Flow Screens27
 - 6.2.2 Main Menu27
 - 6.2.3 Status Screen28
 - 6.2.4 Settings Submenu30
 - 6.2.5 Control Screen37
 - 6.2.6 Log Screen38
 - 6.2.7 About Screen42
- 6.3 Editing Display and Operation Settings44
 - 6.3.1 Settings Prompts44
 - 6.3.2 Changing the Password45
 - 6.3.3 Selecting the Display Language46
 - 6.3.4 Setting the Date and Time46
- 7 Maintenance47**
- 7.1 Replacing Batteries47
- 7.2 Charging Batteries49
- 7.3 Checking UPS Operation50
- 7.4 Cleaning the UPS50
- 7.5 Firmware Updates50
- 8 Troubleshooting51**
- 8.1 Symptoms that Require Troubleshooting51
- 8.2 Audible Alarm (Buzzer)51
 - 8.2.1 Faults51
- 8.3 Troubleshooting UPS Issues52
- 9 Specifications53**
- 9.1 Battery Run Times55
- Appendices59**
- Appendix A: Technical Support and Contacts59
- Appendix B: Open Source Software Legal Notices60

1 Important Safety Instructions

IMPORTANT! This manual contains important safety instructions that must be followed during the installation and maintenance of the UPS and batteries. Read this manual thoroughly and the safety and regulatory information, available at <https://www.vertiv.com/ComplianceRegulatoryInfo>, before attempting to install, connect to supply, or operate this UPS.

Comply with all warnings and operating instructions in this manual strictly. Save this manual and carefully read the following instructions before installing the unit. Do not operate this unit before reading all safety information and operating instructions carefully.

Transportation

- Only transport the UPS system in the original packaging to protect against shock and impact.

Preparation

- Condensation may occur if the UPS system is moved directly from a cold to a warm environment. The UPS system must be absolutely dry before installation. Allow at least two hours for the UPS system to acclimate the environment.
- Do not install the UPS system near water or in moist environments.
- Do not install the UPS system where it would be exposed to direct sunlight or near a heater.
- Do not block ventilation holes of the UPS housing.

Installation

- Do not connect appliances or devices which would overload the UPS system (e.g. laser printers) to the UPS output sockets.
- Place cables in such a way that no one can step on or trip over them.
- Do not connect domestic appliances such as hair dryers to UPS output sockets.
- Connect the UPS system only to an earthed shockproof outlet which must be easily accessible and close to the UPS system.
- Please use only VDE-tested, CE-marked mains cable (e.g. the mains cable of your computer) to connect the UPS system to the building wiring shockproof outlet.
- Please use only VDE-tested, CE-marked power cables to connect the loads to the UPS system.
- When installing the equipment, ensure that the sum of the leakage current of the UPS and the connected devices does not exceed 3.5 mA.

Operation

- Do not disconnect the mains cable on the UPS system or the building wiring shockproof outlet during operations since this would cancel the protective earthing of the UPS system and of all connected loads.
- The UPS system features its own, internal power source (batteries). The UPS output sockets or output terminal blocks may be electrically live even if the UPS system is not connected to the building wiring outlet.
- To fully disconnect the UPS system, first press the OFF/Enter button to disconnect the mains.
- Prevent fluids and foreign objects from entering inside the UPS system.

Maintenance, Service, and Faults

- The UPS system operates with hazardous voltages. The repair work must be carried out only by qualified maintenance personnel.



WARNING! Risk of electric shock.

Even after the unit is disconnected from the mains (building wiring outlet), components inside the UPS system are still connected to the battery and electrically live and dangerous.

- Before carrying out any kind of service and/or maintenance, disconnect the batteries and verify that no current is present and no hazardous voltage exists in the terminals of high energy capacitors such as Bus capacitors.
- Only persons that are adequately familiar with batteries and with the required precautionary measures may replace batteries and supervise operations. Unauthorized persons must be kept well away from the batteries.



WARNING! Risk of electric shock.

The battery circuit is not isolated from the input voltage. Hazardous voltages may occur between the battery terminals and the ground. Before touching, verify that no voltage is present!

- Batteries may cause electric shock and have a high short circuit current. Take the precautionary measures specified below and any other measures necessary when working with batteries:
 - Remove wristwatches, rings, and other metal objects.
 - Use only tools with insulated grips and handles.
- When changing batteries, install the same number and same type of batteries.
- Do not dispose of batteries by burning them. This could cause battery explosion.
- Recycle or dispose of batteries according to local regulations.
- Do not open or destroy batteries. Escaping electrolyte can cause injury to the skin and eyes. It may be toxic.
- Replace fuses only with the same type and amperage in order to avoid fire hazards.
- Do not dismantle the UPS system.

2 Product Description

The Vertiv™ Liebert® GXT5 Lithium-ion is a compact, online uninterruptible power system (UPS) that continuously conditions and regulates its output voltage. The Liebert® GXT5 Lithium-ion supplies microcomputers and other sensitive equipment with clean sine wave input power.

Upon generation, AC power is clean and stable. However, during transmission and distribution it is subject to voltage sags, spikes, and complete failure that may interrupt computer operations, cause data loss, and damage equipment.

The Liebert® GXT5 Lithium-ion protects equipment from these disturbances. The Liebert® GXT5 continuously charges its batteries from the mains, enabling it to supply power to connected loads, even when the mains fail.

2.1 UPS Features and Available Models

The Liebert® GXT5 Lithium-ion includes the following features. **Table 2.1** below, lists the available models and power ratings.

- Enhanced load capacity with an output power factor of 1.
- Input power factor greater than 0.99.
- Optional tower or rack installation to meet varying installation requirements.
- Adapts to areas with unstable power mains supply via high frequency double conversion topology structure, with high input power factor, wide input voltage range, and output immune to grid interference.
- Operation and display panel with model-specific color LCD offers simple configuration and control of the UPS.
- ECO power supply mode and smart-sleep mode helps to save the maximum amount of energy.

Table 2.1 UPS Models and Power Ratings

Model Number	Nominal Power Rating at 208 V Input	Nominal Power Rating at 230 V Input
GXT5LI-5KL630RT3UXLN	5000 VA/4400 W	5000 VA/4900 W
GXT5LI-5000GVRT3UXLN	5000 VA/5000 W	5000 VA/5000 W
GXT5LI-6000GVRT3UXLN	5650 VA/5650 W	6000 VA/6000 W
GXT5LI-8000GVRT3UXLN	8000 VA/8000 W	8000 VA/8000 W
GXT5LI-10KGVRT3UXLN	10000 VA/10000 W	10000 VA/10000 W

2.2 Front Panels

The various Vertiv™ Liebert® GXT5 Lithium-ion models have the same general appearance. The difference between the varying models is the type of receptacle that is located on the rear panel.

Figure 2.1 Liebert® GXT5 Lithium-ion UPS Front View



Figure 2.2 External Battery Cabinet (EBC) Front View



2.3 Rear Panels

The **Figure 2.3** below, **Figure 2.4** on the next page and **Figure 2.5** on page 7 detail the rear panel features for each Vertiv™ Liebert® GXT5 Lithium-ion UPS and EBC.

Figure 2.3 GXT5LI-5KL630RT3UXLN UPS Rear Panel

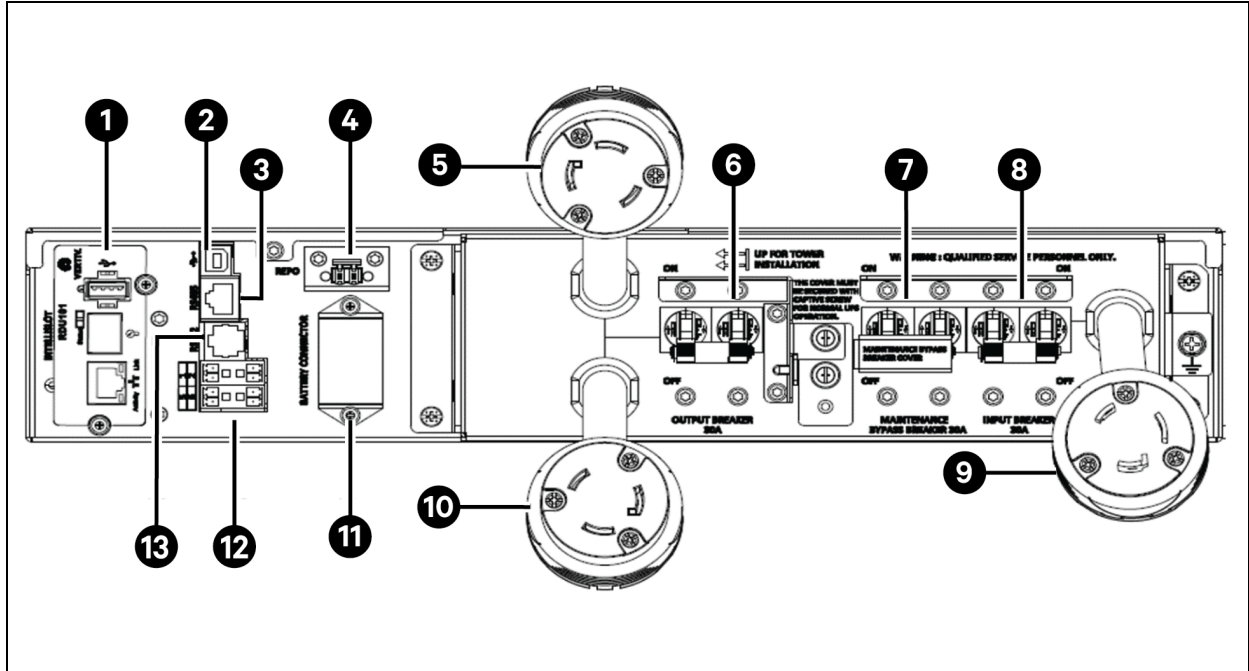

Item	Description
1	Preinstalled network card
2	USB port
3	EBC communication port (RS-485)
4	REPO connector
5	L6-30R output
6	Output circuit breaker
7	Maintenance bypass circuit breaker
8	Input circuit breaker
9	L6-30P input
10	L6-30R output
11	EBC connector
12	Dry contact communication terminal block
13	RS-232 port (used for CLI)

Figure 2.4 GXT5LI-5000/6000/8000/10KGVRT3UXLN UPS Rear Panel

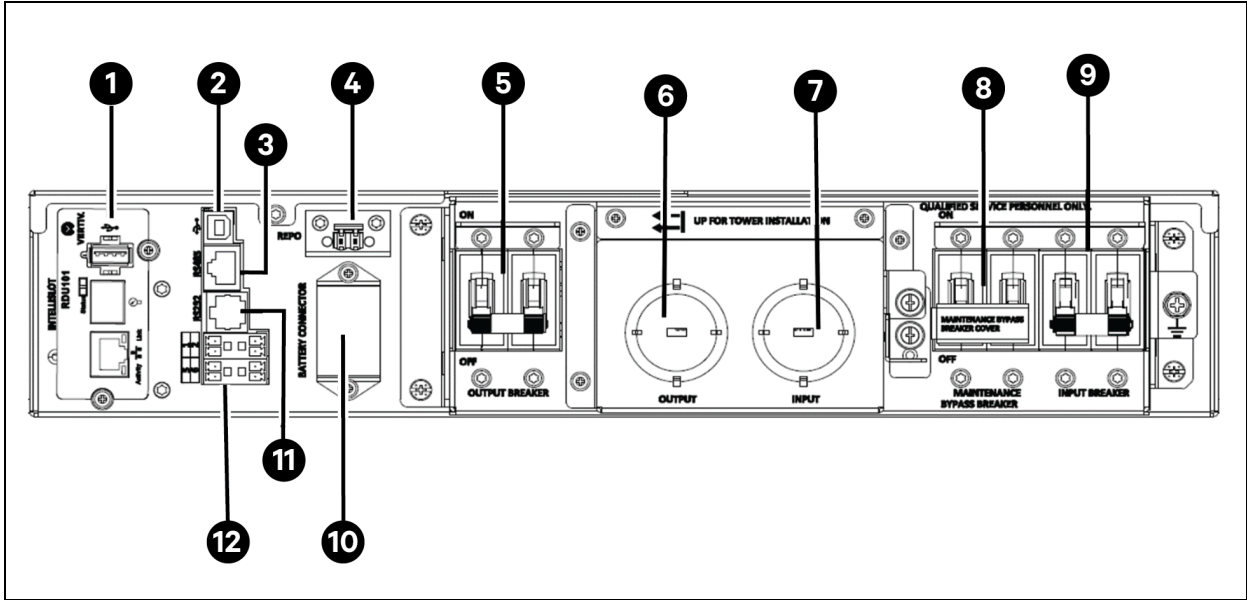

Item	Description
1	Preinstalled network card
2	USB port
3	EBC communication port (RS-485)
4	REPO connector
5	Output circuit breaker
6	Output hardwire connection
7	Input hardwire connection
8	Maintenance bypass circuit breaker
9	Input circuit breaker
10	EBC connector
11	RS-232 port (used for CLI)
12	Dry contact communication terminal block

Figure 2.5 VEBCLI-192VRT1U EBC Rear Panel

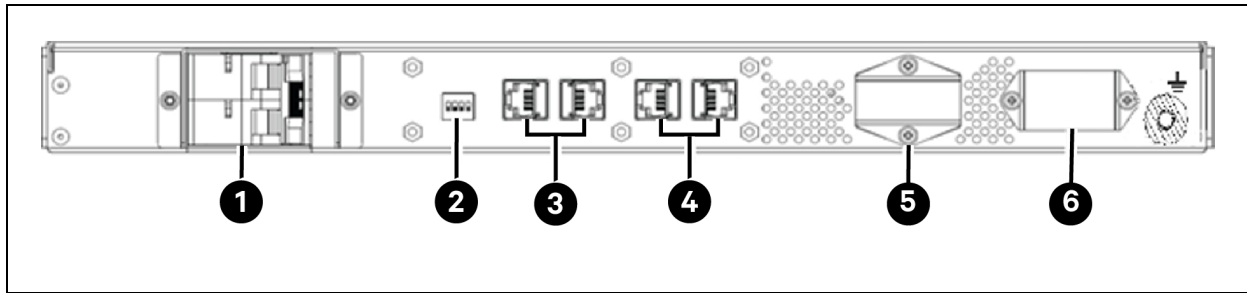

Item	Description
1	Battery breaker (63A)
2	Address dip switches
3	COM ports (RS-485)
4	CAN ports
5	Battery port A
6	Battery port B

2.4 Maintenance Bypass Cabinet

The 5-10kVA Vertiv™ Liebert® GXT5 Lithium-ion models ship with a maintenance bypass cabinet (MBC). This MBC includes input and output wiring terminal block, and input, output, and maintenance bypass circuit breakers, see [Rear Panels](#) on page 5.

The MBC needs to be installed on the UPS. Refer to [Installing the UPS and External Battery Cabinet](#) on page 12 for details.

2.5 External Battery Cabinets

EBCs are required with these Liebert® GXT5 Lithium-ion UPS models as they do not have internal batteries. The [Table 2.2](#) below illustrates the minimum number of EBCs required and maximum number of EBCs allowed per model. The UPS ships with the minimum number of EBCs required for the model. Additional EBCs may be connected in parallel to the UPS to provide additional battery run time. For approximate battery run times with additional EBCs, see [Battery Run Times](#) on page 55. By default, battery cabinets will be automatically detected by the UPS once connected. Auto detection can be changed in the settings menu. For more information, see [Settings Submenu](#) on page 30.

See [Rear Panels](#) on page 5 for details related to the rear panel of the EBC.

Table 2.2 UPS and EBC Requirement

UPS Model	Minimum Number of EBCs Required	Maximum Number of EBCs	EBC Model
GXT5LI-5KL630RT3UXLN	1	8	VEBCLI-192VRT1U
GXT5LI-5000GVRT3UXLN			
GXT5LI-6000GVRT3UXLN			
GXT5LI-8000GVRT3UXLN			
GXT5LI-10KGVRT3UXLN			

2.6 Major Internal Components and Operating Principle

Figure 2.6 below, shows the UPS operating principle and Figure 2.6 below, describes the function of the major components in the UPS.

NOTE: Figure 2.6 below, is one example of basic operation.

Figure 2.6 Basic Operating Principle Diagram

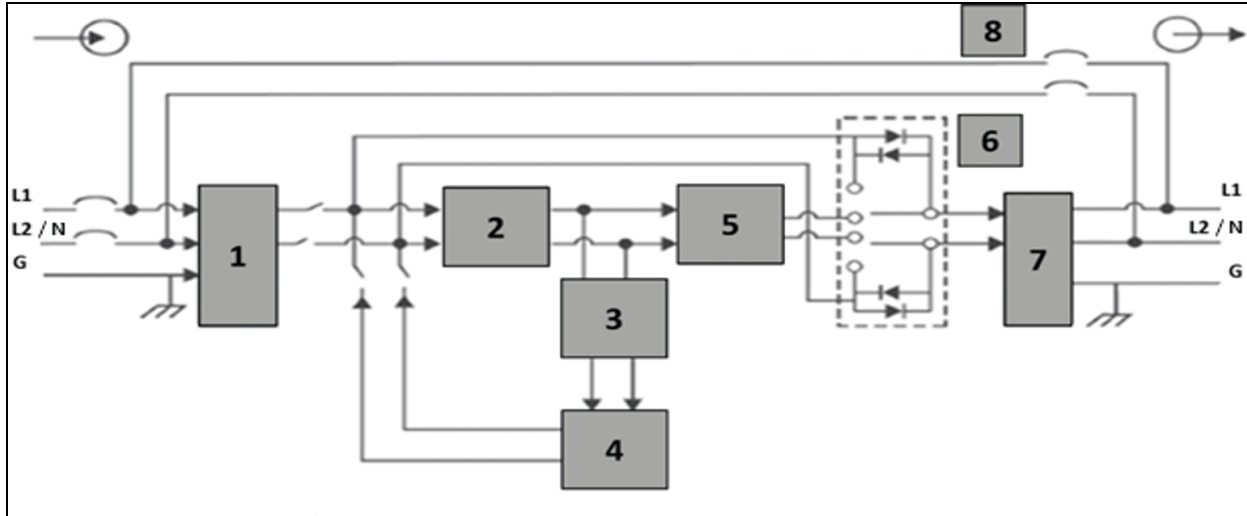

Table 2.3 Major Components

Item	Component	Operation/Function
1	Transient Voltage Surge Suppression (TVSS) and EMI/RFI Filters	Provides surge protections, and filters electromagnetic interference (EMI) and radio frequency interference (RFI). Minimizes surges or interference present in the utility power and protects devices connected to the UPS.
2	Rectifier/Power Factor Correction (PFC) Circuit	In normal operation, converts utility AC power to regulated DC power for use by the inverter while ensuring that the wave shape of the input current used by the UPS is near ideal. Extracting this sine-wave input current ensures efficient use of utility power and reduces reflected harmonic distortion making cleaner power available to devices that are not protected by the UPS. The DC-to-DC converter raises the DC voltage from the battery to the optimum operating voltage for the inverter. This allows the inverter to operate continuously at its optimum efficiency and voltage, thus increasing reliability.
3	Battery Charger	Regulates input AC power to continuously float-charge the batteries. Batteries are charged when the UPS is plugged in, even when not powered-on.
4	Batteries	Lithium-ion NOTE: To maintain battery design life, operate the UPS in an ambient temperature of 59 °F to 86 °F (15 °C to 30 °C).
5	Inverter	In normal operation, inverts the DC output of the PFC circuit into precise, regulated sine wave AC power. When utility power fails, the inverter receives DC power from the DC-to-DC converter. In either operating mode, the UPS inverter remains on-line, generating clean, precise, regulated AC output power.

Table 2.3 Major Components (continued)

Item	Component	Operation/Function
6	Dynamic Internal Bypass	In the unlikely event of UPS failure such as overload or over temperature, automatically transfers the connected load to bypass. To manually transfer the connected load from inverter to bypass, see Transferring from Normal to Bypass Mode on page 24.
7	EMI/RFI Filters	Filter EMI and RFI. Minimize interference present in the utility power and protect devices connected on the same branch as the UPS.
8	Maintenance Bypass	In the unlikely event of UPS failure, allows replacing the UPS while keeping the connected equipment powered with utility power. NOTE: The bypass power path does not protect connected equipment from disturbances in the utility supply.

2.7 UPS States and Operating Modes

NOTE: Refer [LED Indicators](#) on page 26, for description of the run indicator and alarm indicator LEDs mentioned in this section.

2.7.1 Normal Mode

When utility power is normal, Normal mode employs the rectifier and inverter to provide voltage and frequency stabilized power to the load. The charger charges the battery in normal mode. On the front panel display, the run indicator (green) is ON, the alarm indicator is OFF, and the buzzer is silent. The LCD Flow screen displays energy flow from the input power source to the battery and then to the UPS inverter.

2.7.2 Bypass Mode

Bypass mode supplies power to the load from the bypass source (utility power), if an overload or fault occurs during normal operation. On the front panel display, the run indicator (green) is ON, the alarm indicator (yellow) is ON, and the buzzer beeps once each second. The LCD Flow screen displays energy flow from the input power source through the bypass path instead of the UPS inverter.

NOTE: If utility power fails or if the utility voltage goes outside of the permissible range during bypass mode operation, the UPS shuts down and no output is supplied to the load.

2.7.3 Battery Mode

Battery mode supplies battery power to the load if utility power fails or if the utility voltage goes outside of the permissible range. On the front panel display, the run indicator (green) is ON, the alarm indicator (yellow) is ON, and the buzzer beeps once each second. The LCD Flow screen displays energy flow from the battery through the UPS inverter. The battery status displays *Discharge*.

NOTE: The batteries are fully charged before shipment. However, transportation and storage inevitably cause some loss of capacity. To ensure adequate backup time, it is recommended to charge the batteries for at least 2 hours before first startup.

NOTE: Powering off the UPS when it is in battery mode results in loss of output power to the connected load.

2.7.4 Frequency Converter Mode

All models of the Vertiv™ Liebert® GXT5 Lithium-ion are capable of frequency conversion. Frequency Conversion Mode can be selected using the configuration program. Allowable frequency operating modes include:

- Auto Sensing - 50 Hz or 60 Hz — Bypass Enabled
- Auto Sensing - 50 Hz or 60 Hz — Bypass Disabled
- Frequency Converter - 50 Hz — Bypass Disabled
- Frequency Converter - 60Hz — Bypass Disabled

NOTE: The default for all models of the Liebert® GXT5 Lithium-ion is *Auto Sensing - 50 Hz or 60 Hz – Bypass Enabled*.

2.7.5 ECO Mode

The energy-saving ECO mode reduces power consumption by powering the load via bypass when the bypass voltage is normal or by powering the load via the inverter when the bypass voltage is abnormal. Use ECO mode to power equipment that is not sensitive to power-grid quality via bypass and reduce power consumption.

NOTE: During ECO mode, if a bypass failure or abnormal bypass voltage notification appears when the output is not overloaded, the UPS will transfer to *Normal Mode*. However, if a notification showing bypass failure or abnormal bypass voltage appears when the output is overloaded, the UPS will shutdown the bypass and therefore the load will shutdown.

3 Installation

Do not start the UPS until the installation is finished.



WARNING! This is a product for commercial and industrial application in the second environment – installation restrictions or additional measures may be needed to prevent disturbances.



WARNING! Risk of electric shock.

Can cause equipment damage, injury and death. Before beginning installation, verify that all external over current protection devices are open (off), and that they are locked out and tagged appropriately to prevent activation during the installation, verify with a voltmeter that power is off and wear appropriate, OSHA approved personal protective equipment (PPE) per NFPA 70E. Failure to comply can cause serious injury or death. Before proceeding with installation, read all instructions. Follow all local codes.

3.1 Unpacking and Inspection

Unpack the UPS and conduct the following checks:

- Inspect the UPS for shipping damage. If any shipping damage is found, report it to the carrier and your local Vertiv representative immediately.
- Check the accessories included against the packing list. If there is any discrepancy, contact local Vertiv representative immediately.



CAUTION: The UPS is heavy, see [Specifications](#) on page 53, for the weight. Take proper precautions when lifting or moving the unit.

3.2 Pre-Installation Preparation

Install the UPS indoors in a controlled environment, where it cannot be accidentally turned off. The installation environment should meet the specifications listed in [Specifications](#) on page 53.

Place the UPS in an area of unrestricted airflow around the unit, away from water, flammable liquids, gases, corrosives, and conductive contaminants. Avoid direct sunlight.

NOTE: Operating the UPS in temperatures above 77 °F (25 °C) reduces battery life.

3.2.1 Installation Clearances

Maintain at least 4 in. (100 mm) clearance in the front and rear of the UPS. Do not obstruct the air inlets on the front panel and rear panel of the UPS. Blocking the air inlets reduces ventilation and heat dissipation, shortening the service life of the unit.

3.3 Installing the UPS and External Battery Cabinet

The UPS may be installed as a tower or in a rack, depending on available space and use considerations. Installation instructions vary based on the model. Refer to the Quick Installation Guide included in the package or available online at www.vertiv.com.

NOTE: When installing the UPS or connecting input and output connections, comply with all relevant safety codes and standards.



WARNING! Risk of electric shock.

Can cause injury or death. Disconnect all local and remote electric power supplies before working with the UPS. Ensure that the unit is shutdown and power has been disconnected before beginning any maintenance.



CAUTION: The EBC is heavy, see **Table 9.2** on page 54. Take proper precautions when lifting them.

3.4 Hardwired Input/Output Connections



WARNING! Risk of electric shock.

Can cause equipment damage, injury and death. Before beginning installation, verify that all external over current protection devices are open (off), and that they are locked-out and tagged appropriately to prevent activation during the installation, verify with a voltmeter that power is off and wear appropriate, OSHA approved personal protective equipment (PPE) per NFPA 70E. Failure to comply can cause serious injury or death. Before proceeding with installation, read all instructions. Follow all local codes.

Observe the following guidelines and specifications when making the hard-wire input and output connections:

- It is recommended installing a UL489 approved breaker upstream of unit.
- Provide circuit breaker protection according to local codes. The mains disconnect should be within sight of the UPS or have an appropriate lockout.
- Maintain service space around the UPS or use flexible conduit.
- Provide output distributions panels, circuit breaker protection, or emergency disconnects according to local codes.
- Do not install input and output wiring in the same conduit.
- The GXT5LI-5KL630RT3UXLN uses a cord connected input plug that is used as the power disconnect device. This model UPS must be installed near a wall socket or outlet that is easily accessible per the National Electric Code/NFPA 70 requirements.

3.4.1 Branch Circuit Breaker

The installer must provide an upstream branch circuit breaker, see [Terminal Block Connections](#) on page 15, for the ratings. The MBC includes an input, output, and maintenance bypass circuit breakers. The input circuit breaker disconnects input power to the UPS. The output circuit breaker disconnects output power from the UPS. The maintenance bypass breaker bypasses power directly from the input terminal block to the output terminal block. The input circuit breaker does not disconnect power from the maintenance bypass breaker. **Figure 3.1** on the facing page, shows the circuit breaker diagram.

Observe the following guidelines and specifications when making the hard-wire input and output connections:

- Provide circuit breaker protection according to local codes. The mains disconnect should be within sight of the UPS or have an appropriate lockout.
- Maintain service space around the UPS or use flexible conduit.
- Provide output-distributions panels, circuit-breaker protection, or emergency disconnects according to local codes.
- Do not install input and output wiring in the same conduit.

Table 3.1 GV Panel Feeder Breaker

UPS Model	Recommended Panel Feeder Breaker
GXT5LI-5KL630RT3UXLN	30 A
GXT5LI-5000GVRT3UXLN	50 A
GXT5LI-6000GVRT3UXLN	
GXT5LI-8000GVRT3UXLN	60 A
GXT5LI-10KGVRT3UXLN	70 A

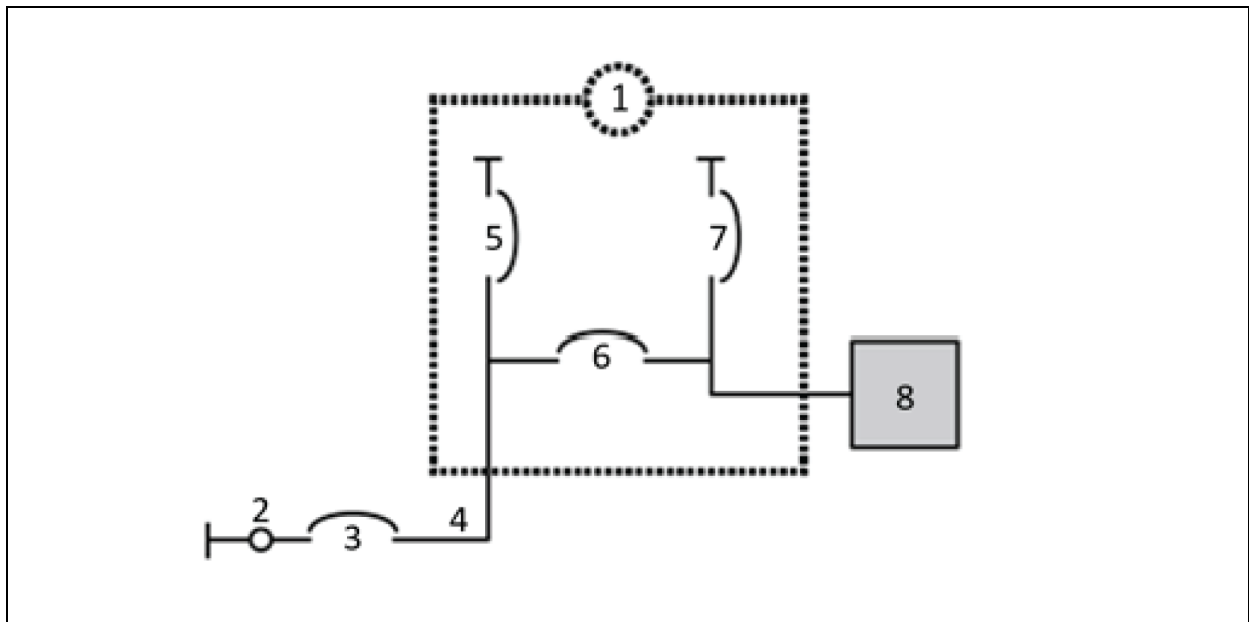
Figure 3.1 Circuit Breakers Diagram

Item	Description
1	UPS
2	Mains/Utility
3	Panel feeder breaker
4	Mains/Utility
5	Input circuit breaker

Item	Description
6	Maintenance bypass circuit breaker
7	Output circuit breaker
8	Output Distribution

3.4.2 Terminal Block Connections

On the GXT5LI-5000GVRT3UXLN, GXT5LI-6000GVRT3UXLN, GXT5LI-8000GVRT3UXLN, and GXT5LI-10KGVRT3UXLN models, hardwire connections to the terminal blocks are made through knockouts on MBC. Refer to section [Rear Panels](#) on page 5 for the location of the input/output knockouts on your model.

For details on electrical connection specifications, see [Table 3.2](#) below.

Table 3.2 Terminal Block Electrical Specifications

UPS Model	Recommended Wire Size (Including Ground Wire) (90°C Copper Wire)	Maximum Wire Size Accepted by Terminal Block	Terminal Tightening Torque	
			Phillips Screw Type Terminal Block	Flathead Screw Type Terminal Block
GXT5LI-5KL630RT3UXLN	Not applicable	Not applicable	Not applicable	Not applicable
GXT5LI-5000GVRT3UXLN	8 AWG (10 mm ²)	4 AWG (21.2 mm ²)	25 lb-in (2.82 Nm) for 8 AWG	26 lb-in (2.93 Nm)
GXT5LI-6000GVRT3UXLN			35 lb-in (3.95 Nm) for 4-6 AWG	
GXT5LI-8000GVRT3UXLN	6 AWG (13.3 mm ²)	4 AWG (21.2 mm ²)	35 lb-in (3.95 Nm)	26 lb-in (2.93 Nm)
GXT5LI-10KGVRT3UXLN	4 AWG (21.2 mm ²)			

To make the terminal block connections:

1. Loosen the screws from the cable entry/conduit box cover and pull the cables through the cable entry hole/knockout leaving some slack for connection.

NOTE: It is recommended using the knockouts to install input and output wiring in separate conduit. Use a suitable cable gland or risk electric shock.

2. Referring to the appropriate terminal block connection instructions, connect the cables to the corresponding input/output terminals and use a torque wrench to turn the screw clockwise until tightened as specified in [Table 3.2](#) above.
3. Re-install the cable entry/conduit box cover and tighten the screws.

Figure 3.2 Terminal Block

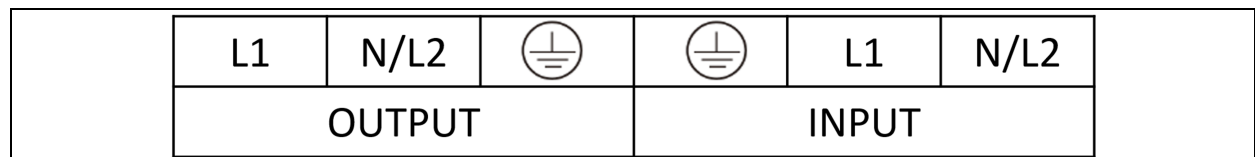

3.4.3 Connecting to Terminal Blocks on 5 kVA, 6 kVA, 8 kVA, and 10 kVA Models

These models offer a single type of I/O connection, 1-in 1-out common source. [Figure 3.2](#) above, shows the terminal block. Refer to the details in [Terminal Block Connections](#) above, when making the connections.

3.4.4 Connecting the EBCs and Setting Up the ADDRESS DIP Switch

1. This GXT5 Lithium-Ion UPS has no internal batteries, at least one VEBCLI-192VRT1U EBC is required. Additional EBC strings provide longer battery run time for connected devices.
2. Verify that the EBC breaker is in the Off position.

3. Connect port B of the EBC cable (included in the package) to the UPS (1a). Connect port A of the EBC cable to port A of the EBC (1b). Connect one end of a communication cable to UPS RS485 port (1c) and the other end to EBC COM port (1d).
4. If connecting more than one external battery, connect port B of an additional EBC cable to port B on the first EBC (2a) and port A of the EBC cable to port A of the second EBC (2b). Connect one end of a communication cable to the COM port of the first EBC (2c) and the other end to the COM port of the second EBC (2d). Connect one end of a communication cable to the CAN port of the first EBC (2e) and the other end to the CAN port of the second EBC (2f).
5. Repeat Step 3 for each additional battery cabinet.
6. Set ADDRESS DIP switch on each EBC as per the **Table 3.3** below.

Figure 3.3 GXT5 Lithium-Ion UPS and EBC Connections

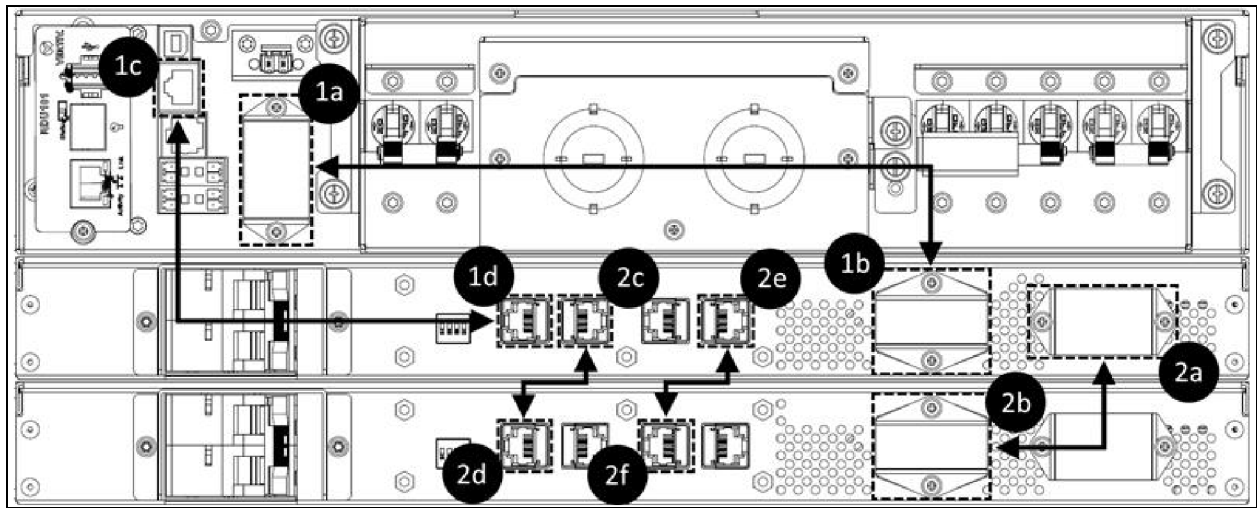

Table 3.3 DIP Switch Position

EBC Address	DIP Switch Position			
	1	2	3	4
1	OFF	OFF	OFF	OFF
2	OFF	OFF	OFF	ON
3	OFF	OFF	ON	OFF
4	OFF	OFF	ON	ON
5	OFF	ON	OFF	OFF
6	OFF	ON	OFF	ON
7	OFF	ON	ON	OFF
8	OFF	ON	ON	ON

3.5 Communication Connections

The UPS offers several communication interfaces and ports.

NOTE: It is recommended that signal cable lengths be less than 10 ft (3 m) and are kept away from power cabling.

3.5.1 Connecting Vertiv™ Liebert® IntelliSlot™ Communication

The Vertiv™ Liebert® GXT5 Lithium-ion 5-10kVA models ship with a Liebert® IntelliSlot™ RDU101 communications card installed. The Liebert® IntelliSlot™ RDU101 communications card provides advanced monitoring and control of the Liebert® GXT5 Lithium-ion. Visit www.vertiv.com/rdu101 for additional information and operation instructions.

See the appropriate figure for your model in [Rear Panels](#) on page 5, for the location of the card port.

Vertiv™ Power Insight can be used with a network communication card to help improve efficiency, protect valuable critical equipment and increases visibility of the UPS. See [UPS Management Software](#) on page 21 for more information.

3.5.2 Connecting to the Dry Contact REPO Port

The UPS includes a dry contact port. See the appropriate figure for your model in [Rear Panels](#) on page 5, for the location of the port. **Figure 3.4** below, shows the ports and **Table 3.4** on the next page describes each port.

The I/O dry contact port ratings are 125 Vac, 0.5 A, 30 Vdc, 1 A.

Figure 3.4 Dry Contact Port and Pin Layout

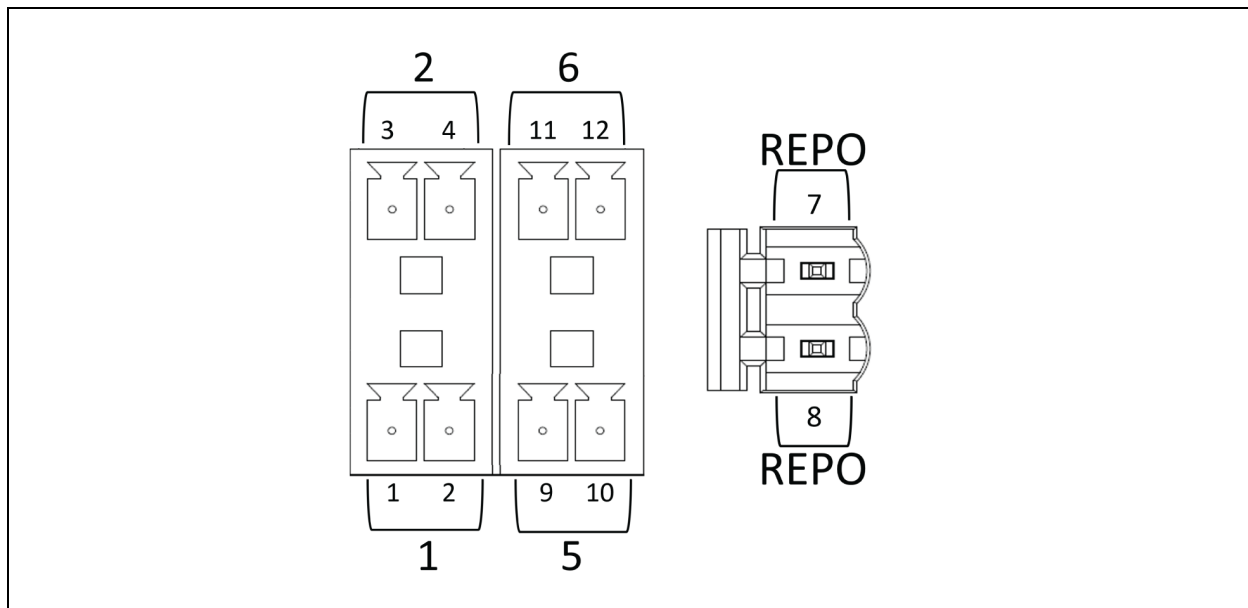

NOTE: Pins 7 and 8 are shorted before delivery.

NOTE: Remote Emergency Power Off (REPO) disables the UPS closes the rectifier, inverter and static bypass, but it cannot disconnect the UPS mains input. To completely disconnect the UPS, disconnect the upstream input circuit breaker when activating the REPO. For details on REPO connection and operation, see [Connecting a Remote Emergency Power Off \(REPO\) Switch](#) on page 19.

Table 3.4 Dry Contact Connection and Pin Out Descriptions

Port No.	Port Name	Pin No.	Pin Name	Description
1	Input 1	1	Remote Comms Shutdown 1	User configurable dry contact input that can be set to trigger the events below. The user can also select the dry contact as either NO or NC, see Input contact NO/NC on page 36. When NO, Pins 1 and 2 are shorted to trigger the event. When NC, Pins 1 and 2 are opened to trigger the event. Options are: <ul style="list-style-type: none"> • Disable (default) • Battery mode shutdown—If the UPS is running on batteries and this input is triggered, the UPS shuts down • Any mode shutdown—If this input is triggered, the UPS shuts down regardless of current operating mode
		2	Signal Ground	Signal Ground
2	Input 2	3	Remote Comms Shutdown 2	User configurable dry contact input that can be set to trigger the events below. The user can also select the dry contact as either NO or NC, see Input contact NO/NC on page 36. When NO, Pins 3 and 4 are shorted to trigger the event. When NC, Pins 3 and 4 are opened to trigger the event. Options are: <ul style="list-style-type: none"> • Disable (default) • Battery mode shutdown— If the UPS is running on batteries and this input is triggered, the UPS shuts down • Any mode shutdown—If this input is triggered, the UPS shuts down regardless of current operating mode
		4	Signal Ground	Signal Ground
5	Output 5	9,10	Remote Fault Alert 5	User configurable dry contact output that can be set to alert the user to the faults below. The user can also select the dry contact as either NO or NC, see Output contact NO/NC on page 36. When NO, Pins 9 and 10 are shorted when the fault occurs. When NC, Pins 9 and 10 are opened when the fault occurs. Options are: <ul style="list-style-type: none"> • Low battery (default) • On battery • On bypass • UPS fault
6	Output 6	11,12	Remote Fault Alert 6	User configurable dry contact output that can be set to alert the user to the faults below. The user can also select the dry contact as either NO or NC, See Output contact NO/NC on page 36. When NO, Pins 11 and 12 are shorted when the fault occurs. When NC, Pins 11 and 12 are opened when the fault occurs. Options are: <ul style="list-style-type: none"> • Low battery • On battery • On bypass • UPS fault (default)
REPO	REPO Input	7	+5V	REPO power supply, 5-Vdc 100-mA
		8	REPO Coil - NC	NC, activated when Pin 7 and Pin 8 is open. NOTE: For details on REPO connection and operation, see Connecting a Remote Emergency Power Off (REPO) Switch on the facing page.

3.5.3 Connecting a Remote Emergency Power Off (REPO) Switch

The UPS includes a REPO connection in the dry contact port. See the appropriate figure for your model in [Rear Panels](#) on page 5, for the location of the port.

UPS ships with a REPO jumper installed, allowing the UPS to operate as a normally closed switch system (fail safe). Opening the circuit disables the UPS. To connect a REPO switch that opens the circuit to shutdown the rectifier and inverter and power off the UPS, use a cable from the remote switch to plug into the REPO-port on the UPS.

In normal conditions, the REPO switch cannot disconnect the UPS input power. When the REPO switch trips, the UPS generates an alarm and immediately cuts-off output power. When the emergency condition is resolved, the UPS will not return to normal operation until you reset the REPO switch and manually power on the UPS.

To make the cable for the REPO connection:

Figure 3.5 below, shows the cable required to make the connection. It is recommended using 18 AWG to 22 AWG (0.82 mm² to 0.33 mm²) copper-core cable.

1. Remove the insulation from the end of two cables.
2. Insert the stripped end into the plug terminals 1 and 2 respectively, then tighten the terminals. Make sure that the cables are secure in the plug to prevent failure because of loose contact.

To make the cable for the REPO connection:



CAUTION: To maintain safety (SELV) barriers and electromagnetic compatibility, signal cables should be shielded and run separately from power cables.

1. Connect one end of the cable to the remote switch, see **Figure 3.5** below.
2. Remove the factory-installed jumper from pins 7 and 8 of the dry contact port on the UPS.
3. Connect the plug to pins 7 and 8.

Figure 3.5 Cable/Plug for Connecting REPO Switch to UPS REPO Port

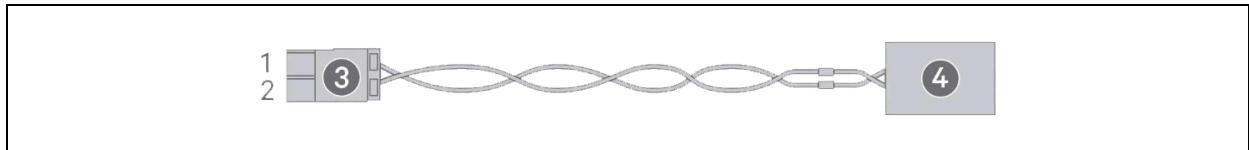

Table 3.5 Cable/Plug for Connecting REPO Switch to UPS REPO Port

Item	Description
1	Terminal 1
2	Terminal 2
3	Plug (connects to REPO port on UPS)
4	REPO switch

3.5.4 Connecting a USB Cable

The UPS includes a USB connector. See the appropriate figure for your model in [Rear Panels](#) on page 5, for the location of the port.

The standard, B-type USB port connects the UPS to a network server or other computer system. The USB port supports HID/CDC protocol. The CDC protocol is reserved for service software. To use the HID protocol for monitoring, get Vertiv™ Power Assist software from www.vertiv.com/PowerAssist.

3.5.5 Connecting CLI Communication Cables

The UPS supports the Vertiv command-line interface for operation with Vertiv ACS and other third-party monitoring protocols. The RJ-45 port (labeled “R232”) is used for CLI connection. See the appropriate figure for your model in [Rear Panels](#) on page 5, for the location of the port. The pin out, described in below table is consistent with the ACS pin out.

Pin	Signal
1	NC
2	NC
3	TXD (out)
4	GND
5	NC
6	RXD (in)
7	NC
8	NC

4 UPS Management Software

Vertiv offers two UPS management software packages:

Vertiv™ Power Insight software provides UPS management and graceful unattended system shutdown in the event of an extended power outage. Power Insight requires a network card. Visit www.vertiv.com/powerinsight for a free download of the software and additional information.

Vertiv™ Power Assist is an easy to use management and shutdown software package. Power Assist connects locally to the UPS via a USB port. Visit www.vertiv.com/powerassist for a free download of the software and additional information.

This page intentionally left blank

5 Operating the UPS



WARNING! Risk of electric shock.

Can cause injury or death. Hazardous mains and/or battery voltage exists behind the protective cover. No user accessible parts are located behind the protective covers that require a tool for removal. Only qualified service personnel are authorized to remove such covers. If maintenance for UPS is needed, notice that the neutral line is live.

5.1 Silencing the Audible Alarm

The audible alarm may sound during UPS operation. To silence the alarm, press and hold the **ESC** button for 2 seconds. The button is located on the front panel display, see [Operation and Display Panel](#) on page 25.

5.2 Starting Up the UPS

IMPORTANT! Do not start the UPS until the installation is finished, the system is commissioned by an authorized engineer, and the external input circuit breakers are closed.



CAUTION: Starting the UPS applies mains/utility power to the output terminals. Make sure that the load power is safe and ready to accept power. If the load is not ready, isolate the load with the output terminal.

The UPS starts in *Normal Mode*.

To start the UPS:

1. Confirm the maintenance bypass switch is in the open (off) position and that the guard is secured in place.
2. Ensure that the REPO connector on the rear of the unit has a jumper between pins 7-8 or that it is properly wired to an Emergency Power Off circuit (normally closed).
3. Confirm the panel feeder breaker supplying power to the UPS is closed.
4. Close the input circuit breaker on the rear of the MBC.
5. Close the output breaker on the rear of the MBC.
6. Close the breakers on the rear of the connected EBC.
7. If this is the first time startup of the UPS, the Startup Guidance wizard opens to set the basic parameters of the UPS. Follow the prompts.
8. When the UPS is first connected startup guidance screens will appear. Use the Up, Down, and Enter buttons to confirm settings. Then, press and hold the **Power** button until a confirmation dialog appears. Use the **Up/Down** arrows to select Yes, then press **Enter**.

NOTE: The UPS will sound an alarm when the output is not powered. Press and hold the **Esc** button for two seconds to mute the alarm.

For detailed description of UPS display functions and settings, see [Operation and Display Panel](#) on page 25.

5.3 Transferring to Battery Mode

The UPS operates in *Normal Mode* unless the input power fails or a battery self test is running. When the input power fails the UPS automatically transfers to *Battery Mode*. The UPS will run in *Battery Mode* for the backup time available or until the input power is restored. Once input power is restored the UPS automatically returns to *Normal Mode*.

NOTE: Battery backup run times are listed in [Battery Run Times](#) on page 55.

5.4 Transferring from Normal to Bypass Mode

Press and hold the **Power** button for 2 seconds.

If the UPS is operating normally, without faults, the option to *Turn to bypass*, *Turn off output*, or *Turn off UPS* displays:

- a. Use the arrow buttons to select *Turn to bypass*, and press **Enter**.
- b. Use the arrow buttons to select No or Yes, then press **Enter** to confirm.

NOTE: If the bypass power is outside normal operating range, the option *Turn off the UPS* displays. Use the arrow buttons to select No or Yes, then press **Enter** to confirm.

5.5 Transferring from Bypass to Normal Mode

Press and hold the **Power** button for 2 seconds.

If the UPS is operating normally, without faults, the option to continue to *Turn on UPS*, *Turn off output*, or *Turn off UPS* displays:

- a. Use the arrow buttons to select *Turn on UPS*, then press **Enter**.
- b. Use the arrow buttons to select No or Yes, then press **Enter** to confirm.

NOTE: The UPS automatically switches from bypass to normal mode after an *overheated* or *overloaded* fault is cleared and normal power is restored.

5.6 Shutting Down the UPS Completely



WARNING! Risk of electric shock.

Can cause injury or death. Disconnect all local and remote electric power supplies before working with the UPS. Ensure that the unit is shutdown and power has been disconnected before beginning any maintenance.

Confirm power to load is not needed. Press and hold the **Power** button. Select *Turn off UPS* then press the **Enter** button. Open the input circuit breaker on the rear of the MBC.

5.7 Remote Emergency Power Off (REPO)

REPO turns off the UPS in case of any emergency conditions. When an emergency occurs, the REPO switch turns off the rectifier and inverter and stops powering the load immediately. The battery stops charging and discharging.

To manually power off in an emergency, disconnect the terminal connecting the REPO port on the rear of the UPS.

If mains/utility power is connected to the UPS input, the UPS control circuit remains active even though output power is disabled. To remove all mains/utility power, disconnect the external input circuit breaker.

6 Operation and Display Panel

The operation/display panel includes LED indicators, function keys, and an LCD interface to configure and control UPS operation.

Figure 6.1 UPS Front panel Display

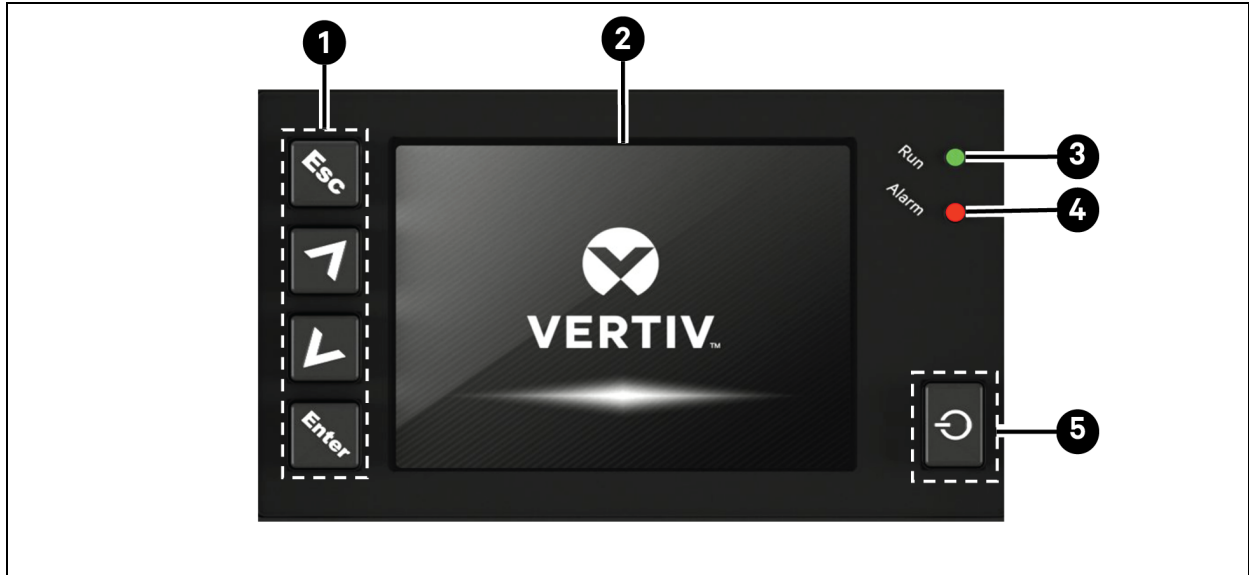

Item	Description
1	Menu keys, see Table 6.1 below.
2	LCD panel.
3	Run indicator LED, see LED Indicators on the next page .
4	Alarm indicator LED, see LED Indicators on the next page.
5	Power button, see Table 6.1 below.

Table 6.1 Display Panel Button Functions and Descriptions





Button	Function	Description
	Enter	Confirm or enter selection.
	Up/Left	Move to previous page, increase value, move left.
	Down/Right	Move to next page, decrease value, move right.

Table 6.1 Display Panel Button Functions and Descriptions (continued)

Button	Function	Description
	Escape	Go back.
	Power	Power on the UPS, power off the UPS, transfer to Bypass Mode.

NOTE: While the UPS is operating, the LCD will dim and display a screen saver if there is no active alarm or user interaction for 2 minutes, see **Figure 6.2** below. After 4 minutes of inactivity, the display will blank to conserve power. If an alarm or fault occurs or if any button is pressed, the UPS flow screen displays.

Figure 6.2 LCD Screen Saver



6.1 LED Indicators

The LEDs on the front panel display indicate operation and alarm statuses of the UPS.

NOTE: When an alarm is indicated, an alarm message is logged in **Table 6.4** on page 39, describes the alarm messages when a fault is indicated, front panel display list the fault, which are described in **Table 8.1** on page 51.

Table 6.2 LED Functions

Indicator	LED Color	LED State	Indicates
Run indicator	Green	On	UPS output on
		Blinking	Inverter is starting
	None	Off	UPS has no output
Alarm indicator	Yellow	On	Alarm occurs
	Red	On	Fault occurs
	None	Off	No alarm, no fault

6.2 LCD Menu and Screens

The menu driven LCD user interface allows to browse the UPS status, view operating parameters, customize settings, control operation, and view alarm/event history. Use the function keys to navigate through the menu, and view statuses or select settings in the screens.

6.2.1 Startup and Flow Screens

At startup, the UPS executes a system test and displays the Vertiv logo screen for about 10 seconds, shown in **Figure 6.2** on the previous page. After the test completes, an overview screen shows status information, the active (green) power path, and the non-working path (gray).

NOTE: **Figure 6.3** below is an example flow screen and does not reflect the actual values that you may see on your unit.

Figure 6.3 UPS Flow Screen

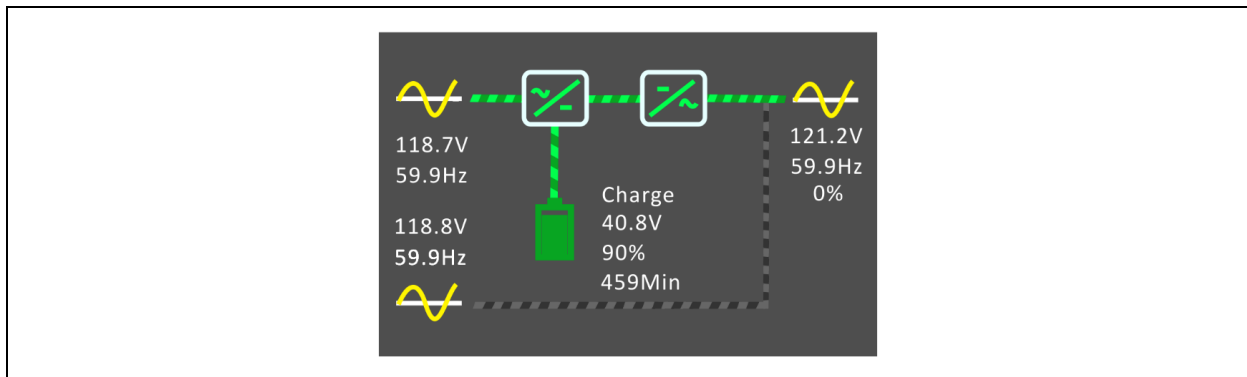

6.2.2 Main Menu

To access the main menu, press **Enter** while at the flow screen. **Table 6.3** below, describes the menu options, and [LCD Menu and Screens](#) above, describes the display.

Use the arrow buttons to select the sub-menu options, and press **Enter** to open the sub menu. Press **ESC** to return to the flow screen.

Table 6.3 Menu Options

Sub Menu	Description
Status	Input, Bypass, Battery, BMS, Output, and Load status information, see Status Screen on the next page .
Settings	Output, Battery, Monitor, and System parameter settings. Settings Submenu on page 30.
Control	UPS controls, see Control Screen on page 37 .
Log	Current alarms and event history, see Log Screen on page 38 .
About	Product and network information, see About Screen on page 42 .
Maintenance	Service-only, service-password protected page for use only by Vertiv service representatives.

Figure 6.4 Main Menu

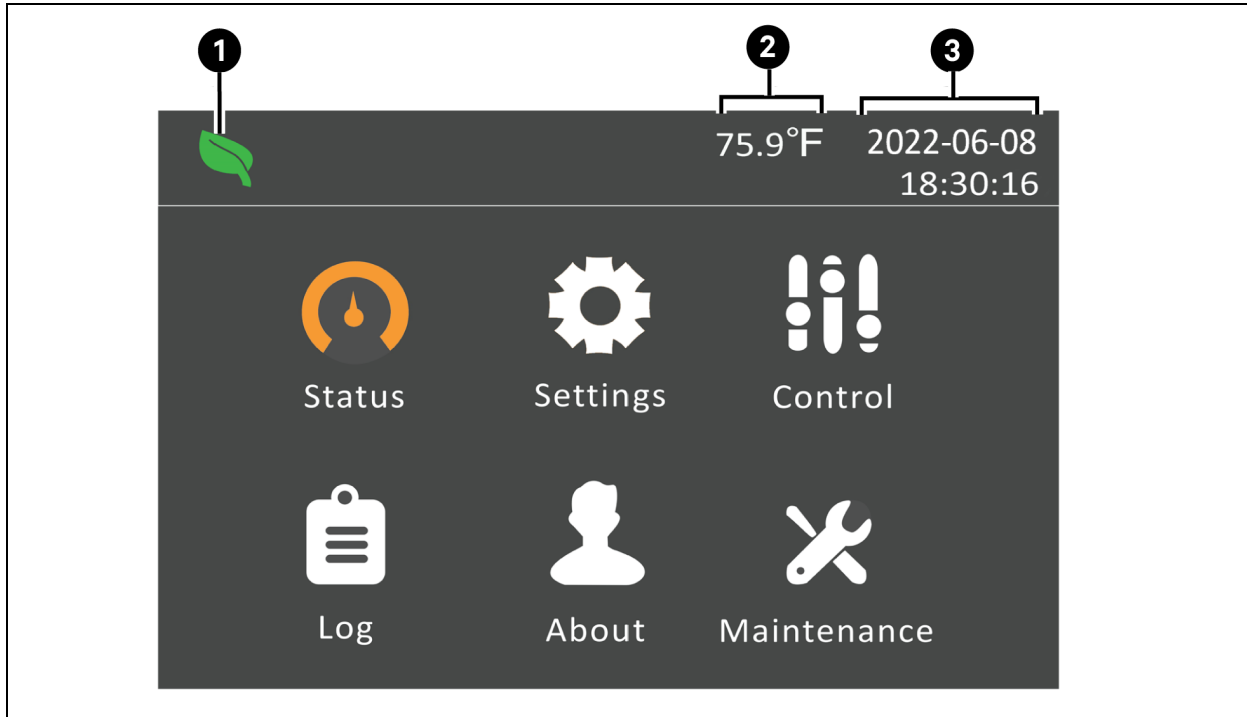

Item	Description
1	ECO-mode indicator
2	Ambient Temperature
3	Date and Time

6.2.3 Status Screen

The status screen displays voltages, currents, frequencies, and other parameters for input, bypass, battery, battery management system (BMS), and output.

To view the UPS status information:

1. At the main menu, select the Status icon, and press **Enter**.
2. Use the arrow buttons to move the cursor left/right and select a tab, then press **Enter** to display the status information for the selected tab.

Figure 6.5 Status Screen Tabs

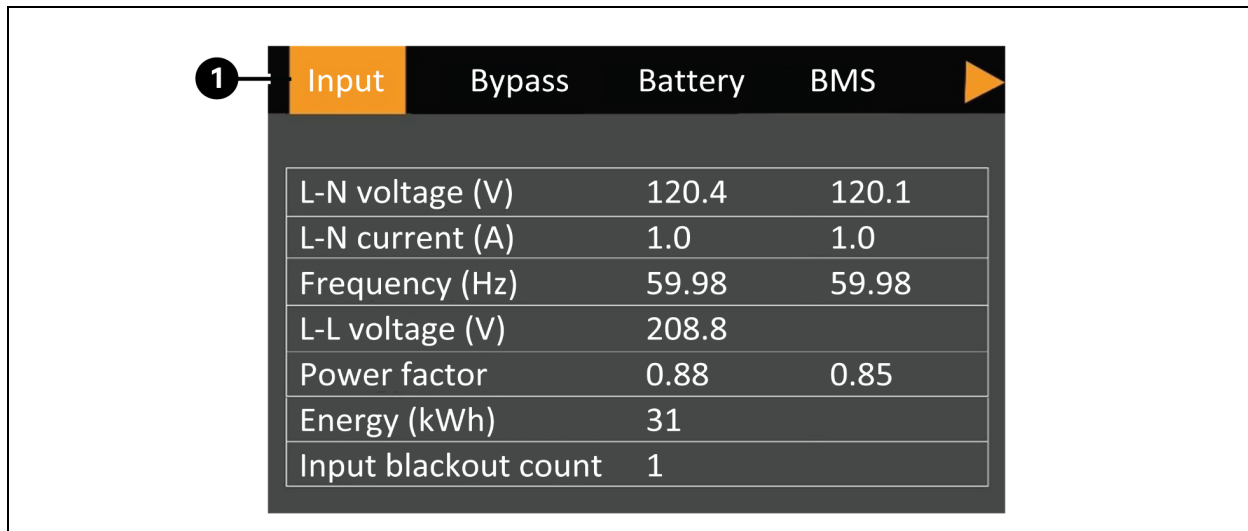

Item	Description
1	Screen tabs with Input tab selected

NOTE: Figure 6.5 above is an example status screen and does not reflect the actual values that will be shown on the screen.

Input Status Options

- L-N voltage (V): Line-neutral voltage of input power.
- L-N current (A): Line-neutral current of input power.
- Frequency (Hz): Frequency of input of input power.
- L-L voltage (V): Line-line voltage of input power.
- Power Factor: Power factor of the input power.
- Energy (kWh): Input power.
- Input black count: The number times that the input voltage was lost or dropped below 60 VAC (black out). Resets to 0 when UPS is powered down.
- Input brown count: The number of times that the input voltage was too low to support the load and the UPS was forced to switch to battery power (brown out). Resets to 0 when the UPS is powered down.

Bypass Status Options

- L-N voltage (V): Line-neutral voltage of bypass power.
- Frequency (Hz): Frequency of bypass power.
- L-L voltage(V): Line-line voltage of bypass power.

Battery Status Options

- Battery status: Current battery state: no battery, test, charging, discharging, idle, or full.
- Battery voltage (V): Voltage of battery power.
- Battery current (A): Current of battery power.
- Backup time (Min): Amount of backup time remaining for battery.

- Remaining capacity (%): Percent of capacity remaining for battery.
- EBC group No.: Number of connected EBCs.
- Battery average temperature (°F): Average temperature of the battery.
- Battery highest temperature (°F): Highest temperature battery has reached.
- Battery lowest temperature (°F): Lowest temperature battery has reached.
- Max cell volt (mV): Maximum voltage the battery cell has reached.
- Min cell volt (mV): Minimum voltage the battery cell has reached.

Battery Management System (BMS)

- Lithium Battery# Status: The status of the internal battery.
- Lithium Battery# SOC (%): The state of charge of the internal battery.
- Lithium Battery# SOH (%): The state of health of the internal battery.

NOTE: Additional status, SOC (%), and SOH (%) lines will populate for each EBC connected.

Output Status Options

- L-N voltage (V): Line-neutral voltage of output power.
- L-N Current (A): Line-neutral current of output power.
- Frequency (Hz): Frequency of output power.
- L-L voltage (V): Line-line voltage of output power.
- Energy (kWh): Output power.

Load Status Options

- Sout (kVA): Apparent output power.
- Pout (kW): Active output power.
- Power Factor: Power factor of output power.
- Load percent (%): Percentage of recent power rated to output power.

6.2.4 Settings Submenu

The settings submenu consists of Output, Battery, Monitor, and System tabs with configurable settings.

NOTE: Do not change parameter settings or reset to factory defaults when powering-off the UPS.

NOTE: Some settings may only be changed when the UPS output is off. For these settings a prompt will appear to shutdown the output.

To modify UPS settings:

1. At the main menu, select the *Settings* icon, and press **Enter**.
2. Use the arrow buttons to enter the settings password and press **Enter**. The default password is 111111 (six ones). See [Editing Display and Operation Settings](#) on page 44 for more details on entering the password and editing the setting parameters.
3. Use the arrow buttons to move the cursor left/right and select a tab, then press **Enter** to display the parameter list for the selected tab.
4. Use the arrow buttons to scroll through the parameter list, and press **Enter** to select a parameter.
5. Use the arrow buttons to select the parameter value, press **Enter** to save the selection or press **Esc** to discard the change.

Output Parameter Options**Voltage selection**

Nominal voltage setting. Set the nominal system voltage to match the input voltage of the UPS.

- 200 V
- 208 V
- 220 V
- 230 V
- 240 V
- Autodetect (default)

NOTE: Autodetect is set as the default. When the UPS starts for the first time, the input voltage is automatically detected and confirmed during startup guidance. After that, the confirmed value appears in the settings menu.

Startup on bypass

Allows the UPS to start up in bypass mode.

- Enable — Start the UPS in bypass mode
- Disable (default) — Start the UPS in normal mode

Frequency selection

Selects the frequency of the output.

- Auto, Bypass enabled (default) — Automatically detects frequency of utility/main power and sets the nominal frequency to match and bypass mode is enabled.
- Auto, Bypass disabled — Automatically detects frequency of utility/main power and sets the nominal frequency to match and bypass mode is disabled.
- 50 Hz, Bypass disable — Bypass mode is disabled and the UPS provides 50 Hz output from any qualified utility/main power.
- 60 Hz, Bypass disable — Bypass mode is disabled and the UPS provides 60 Hz output from any qualified utility/main power.

Bypass voltage upper limit

Sets the percentage that the input voltage may be above the selected output voltage setting and remain in Bypass mode.

- +10% (default)
- +15%
- +20%

Bypass voltage lower limit

Sets the percentage that the input voltage may be below the selected output voltage setting and remain in Bypass mode.

- -10%
- -15% (default)
- -20%

Run mode

Selects Normal or ECO operation for the UPS.

- Normal (default) — Connected load is always powered through the UPS inverter. ECO mode is disabled. (default)
- ECO mode — ECO mode is enabled. The UPS inverter is bypassed, and the connected load is powered by utility/main power within the selected ECO voltage and frequency tolerances.

ECO voltage range

Sets the percentage that the input voltage may be above or below the selected output voltage setting to remain in ECO mode. This option is only shown when Run mode is set to ECO.

- ±5%
- ±10% (default)
- ±15%

ECO frequency range

Sets the amount that the input frequency (Hz) may be above or below the selected frequency setting to remain in ECO mode. This option is only shown when Run mode is set to ECO.

- ±1 Hz
- ±2 Hz
- ±3 Hz (default)

ECO requalification time

To ensure the stability of the utility/main power, this is the length of time that the UPS requires the input voltage and frequency tolerances to be maintained before switching to ECO-mode. This option is only shown when Run mode is set to ECO.

- 1 min (default)
- 5 min
- 15 min
- 30 min

Battery Parameter Options

External Battery Cabinets

Sets the number of attached EBCs or allows the number of EBCs to be detected automatically with Autodetect.

- 0 - 8
- Autodetect (default)

Low battery time

Sounds an alarm when the selected amount of time remaining for the UPS to operate in Battery mode.

- 2 - 30 minutes (default is 2 minutes)

Battery periodic test

The UPS can periodically self-test the battery.

- Enable (default)
- Disable

Battery periodic test interval

Sets the length of time between periodic battery tests.

- 8, 12, 16, 20, or 26 weeks (default is 8 weeks)

Battery periodic test weekday

Sets the day of the week that the battery periodic test is performed.

- Sunday - Saturday (Wednesday is default)

Battery periodic test time

Sets the time that the battery periodic test is performed.

- 00:00 - 23:59 (default is 00:00)

Dischg protect time

Sets the maximum discharge time for the UPS. The default setting is the maximum allowing the battery to fully discharge. This can be set lower to limit the amount of time the UPS will provide battery protection after which it will shutdown. If the discharge time remaining on the battery is lower than the setting value, it will have no effect.

- 1 - 4320 minutes (default is 4320 minutes)

Max chg curr

Sets the maximum charge current for the battery. A higher charge current will charge the battery more quickly but can shorten battery life. A lower value will lengthen the battery charge time and can increase battery life. The load is always prioritized and the charge current will be decreased internally if necessary to support the load.

- 0.6 - 5 A, see [Specifications](#) on page 53

NOTE: The maximum setting with 1 EBC or 1 set of EBCs connected is 3A. If additional EBCs are connected the maximum charging current can be increased to 5A. The actual charging current depends on the operating conditions but will not exceed the set value.

Monitor Settings Options

Language

Selects the language of the display, see [Selecting the Display Language](#) on page 46.

- English (default)
- Français (French)
- Português (Portuguese)
- Español (Spanish)
- 中文 (Chinese)
- Deutsch (German)
- 日本語 (Japanese)
- Русский (Russian)
- čeština (Czech)
- Italiano (Italian)

Date

Selects the current date for the UPS display, YYYY-MM-DD. See [Setting the Date and Time](#) on page 46.

Time

Select the current time for the UPS display, HH:MM:SS. See [Setting the Date and Time](#) on page 46.

Display orientation

Selects the orientation of the display for use in rack or tower configuration.

- Auto-rotate (default) — Automatically rotates based on the detected orientation of the UPS.
- Horizontal — Screen rotated for rack use.
- Vertical — Screen rotated for tower use.

Audible alarm

If enabled, the UPS will beep when an alarm is generated. If disabled, it will be silent. See [Audible Alarm \(Buzzer\)](#) on page 51.

- Enable (default)
- Disable

Change settings password

Opens the dialog to change the password used to access and update the UPS parameter settings, see [Changing the Password](#) on page 45.

System Parameter Options

Auto restart

Allows the automatic restart of the UPS when input power is restored after a shutdown of the UPS due to battery end of discharge (EOD).

- Enable (default) — The UPS will restart automatically when the input power is restored after a complete shut down.
- Disable — The UPS will not restart automatically.

Auto restart delay

Length of time to elapse before an automatic restart after input power is restored.

- 0 - 999 seconds (default is 0 seconds)

Guaranteed shutdown

Forces a continued shutdown of the UPS after the *Low Battery* alarm threshold is reached, even if input power is restored during this time. This can be used to ensure connected equipment shuts down completely after receiving a signal to shutdown from an external monitoring device before power is reapplied. This ensures that once the equipment begins to shutdown, it is brought down completely before power is applied again.

- Enable
- Disable (default)

Start with no battery

Allows the UPS to start when the battery is not installed or is not functional due to damage. This can be used to turn on the UPS and power the attached load without battery protection when utility power is available but battery backup is not.

- Enable (with Auto restart enable) — The UPS will power the load with no user intervention when main power returns after the battery has been fully depleted.
- Enable (with Auto restart disabled) — The UPS will start up and allow the user to turn on the output when power returns after the battery has been fully depleted.
- Disable (default) — The UPS cannot start with a fully depleted battery.

Remote control

Allows the UPS to be controlled remotely via the CLI or RDU101 card.

- Enable (default)
- Disable

Any mode shutdown auto restart enable

Automatically restart the UPS after an *Any mode shutdown* signal is received. When the UPS is shutdown via dry contact inputs 1 or 2, it will restart automatically if this option is enabled.

- Enable
- Disable (default)

Output contact NO/NC

Selects the states of the dry contact outputs 5 and 6.

- Normally open (default)
- Normally closed

Input contact NO/NC

Selects the states of the dry contact inputs 1 and 2.

- Normally open (default)
- Normally closed.

Dry contact 5 (Output)

Selects the output of dry contact 5.

- Low battery (default) — The contacts switch when the UPS reaches the amount of time left on battery configurable from *Low battery time*
- On bypass — The contacts switch when the UPS is running in bypass mode
- On battery — The contacts switch when the UPS is running on battery
- UPS fault — The contacts switch when a UPS fault has occurred

Dry contact 6 (Output)

Selects the output of dry contact 6.

- Low battery — The contacts switch when the UPS reaches the amount of time left on battery configurable from *Low battery time*
- On bypass — The contacts switch when the UPS is running in bypass mode
- On battery — The contacts switch when the UPS is running on battery
- UPS fault (default) — The contacts switch when a UPS fault has occurred

Dry contact 1 (Input)

Selects the action taken by the UPS when the input of dry contact 1 is triggered.

- Disable (default)
- Battery mode shutdown — If the UPS is running on batteries and this input is triggered, the UPS shuts down
- Any mode shutdown — If this input is triggered, the UPS shuts down regardless of current operating mode

Dry contact 2 (Input)

Selects the action taken by the UPS when the input of dry contact 2 is triggered.

- Disable (default)
- Battery mode shutdown — If the UPS is running on batteries and this input is triggered, the UPS shuts down
- Any mode shutdown — If this input is triggered, the UPS shuts down regardless of current operating mode

Sleep mode

Allows the UPS to turn off the output on a weekly schedule. For instance, turn on every Monday at 1:00 and off every Friday at 23:00.

- Enable
- Disable (default)

Power on day of week

Sets the day of week to turn on the UPS. This option is only shown when sleep mode is enabled.

- Sunday-Saturday (default is Monday)

Power on time

Sets the time of day to power on the UPS on the selected day. This option is only shown when sleep mode is enabled.

- 00:00 - 23:59 (default is 00:00)

Power off day of week

Sets the day of week to turn off the UPS. This option is only shown when sleep mode is enabled.

- Sunday-Saturday (default is Saturday)

Power off time

Sets the time of day to power off the UPS on the selected day. This option is only shown when sleep mode is enabled.

- 00:00 - 23:59 (default is 00:00)

IT system compatibility

When this option is enabled, the *Input phase reversed* and *Input ground lost* alarms are disabled.

- Enable
- Disable (default)

6.2.5 Control Screen

The control screen offers UPS control options.

To adjust the UPS controls:

1. At the main menu, select the Control icon, and press **Enter**.
2. Use the arrow buttons to move the cursor to the option, then press **Enter** to select the control.

Figure 6.6 Control Screen

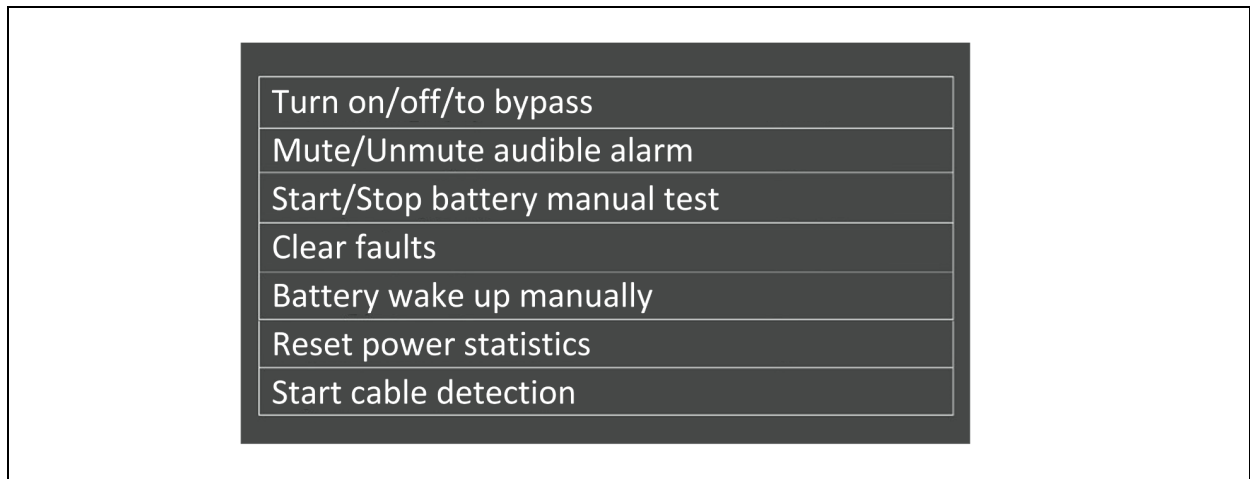

Control Options

- Turn on/off/to bypass — Opens the dialog to change operating modes, see [Operating the UPS](#) on page 23.
- Mute/Unmute audible alarm — Silences or un-silences the audible alarm, see [Silencing the Audible Alarm](#) on page 23.
- Start/Stop battery manual test — Starts the battery self-test manually. If the manual self-test is already running, stop the self-test.
- Clear faults — Clears displayed faults after the issue causing the fault is resolved, see **Table 8.2** on page 51, for a description of the faults.
- Battery wake up manually — The battery may enter a dormant state. Use this feature to wake the battery from the dormant state.
- Reset power statistics — Resets the values tracked to calculate the Efficiency graph, see [About Screen](#) on page 42.
- Start cable detection — Checks whether the power cable connection between EBC and UPS is correct.

NOTE: If input power is lost output power will also be lost while using this feature. It is recommended to use this feature while the UPS output is off.

6.2.6 Log Screen

The Log Screen offers tabs that list the current alarms and the alarm/event history. **Table 6.4** on the facing page, describes the alarm messages you may see in the logs.

To view the logs:

1. At the main menu, select the Log icon, and press **Enter**.
2. Use the arrow buttons to move the cursor left/right and select a tab, then press **Enter** to display the log for the selected tab.

Figure 6.7 Current and History Log Tabs

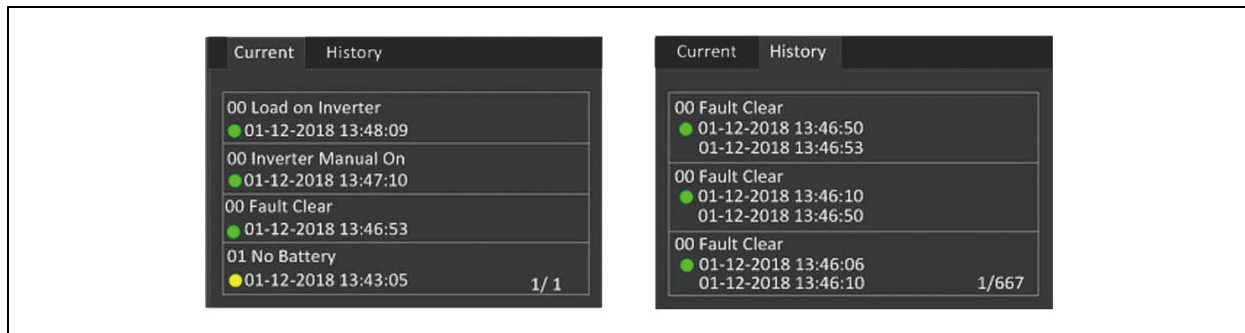

Table 6.4 Alarm Messages

Message	Description
Aux. power fault	UPS internal auxiliary power voltage fault. Contact Vertiv Technical Support.
Battery cabinet connect abnormal	More than 10 EBCs are connected to the UPS. Disconnect excess battery cabinets.
Battery EOD	The battery has reached the end of discharge and mains/utility power is unavailable. Restore the main power. The UPS will power off if it is not restored.
Battery low prewarning	This alarm occurs when the battery approaches the EOD. After the pre-warning, the battery capacity allows two minutes discharge at full load. The user can set the time with the <i>Low Battery Time</i> setting in Battery settings from 2 min - 30 min, (2 min by default). This allows for any loads to be shutdown before the system powers off if utility power cannot be restored.
Battery mode	The UPS operating in battery mode. The alarm will clear when utility power is restored.
Battery over temperature	Battery ambient temperature too high. Ensure that the battery ambient temperature is not higher than setting value 40 to 60 °C (default: 50 °C)
Battery replacement timeout	The system time is past the time set for the batteries to be replaced. If you have disabled the <i>Batt. note duration</i> or have no batteries installed, the alarm will not occur.
Battery reversed	The battery positive and negative are reversed. Reconnect the battery and check the battery cable connections.
Battery test fail	The voltage of the battery was low when the periodic or manual self-test was run. Battery replacement is Recommended.
Battery test started	The battery periodic self-test or manual self-test was started. This will display in the log whenever the event occurs.
Battery test stopped	The battery periodic self-test or manual self-test has finished. This will display in the log whenever the event occurs.
Battery address error	The address is set as 9-16 but must be set as 1-8. Open the battery breaker and check the address setting.
Battery cabinet fault	There is a fault with the EBC.
Battery cabinet parallel fault	Conditions for connecting EBCs in parallel are not met.
Battery cable fault	The CAN communication cable between EBCs is connected incorrectly. Confirm the CAN communication cable are connected to each EBC CAN port. Confirm the CAN communication cable is not damaged.
Battery cable test	The battery cable detection was started. This will clear automatically once detection is complete.

Table 6.4 Alarm Messages (continued)

Message	Description
Battery checking	Appears when the EBC is first connected or the manual battery wake up feature is used.
Battery comm fault	The communication between the UPS and battery is lost. Check whether the communication cable is connected between the UPS RS485 port and the battery COM port. Confirm the cable is not damaged.
Battery current abnormal	The EBC current is abnormal. Open the EBC breaker.
Battery model incompatible	The connected EBC manufacturer is incorrect. Confirm a compatible battery is connected.
Battery No. exceed the limit	More than 8 EBCs or sets of EBCs are connected. Confirm 8 or less EBCs or sets of EBCs are connected.
Battery SN code abnormal	The EBC serial number is inconsistent with the product or multiple EBCs share the same serial number. Confirm a compatible EBC is connected.
Battery temperature abnormal	The EBC temperature is abnormal. Check surroundings for heat sources. Open the EBC breaker.
Battery to utility transition	The UPS has transferred the load to the main power from the battery. This will display in the log whenever the event occurs.
Battery unmatched with the unit	The connected EBC is not suitable for the UPS. Confirm a compatible EBC is connected.
Battery voltage abnormal	The battery voltage exceeds the normal range. Confirm the battery terminal voltage is correct.
Battery waits for charging	The EBC does not meet charging conditions and is in an abnormal state. Check the UPS Log for alarms.
Battery wiring abnormal	An EBC power cable is not connected properly after using the battery cable detection feature.
Bypass abnormal	May be caused by bypass voltage and frequency outside of range, bypass power off and incorrect bypass cables connection. Check that the bypass voltage and frequency are within the setting range. Check the bypass wiring.
Bypass abnormal in ECO mode	May be caused by ECO bypass voltage and frequency outside of range, ECO bypass power off, and incorrect ECO bypass cables connection. Check that the ECO bypass voltage and frequency are within the setting range. Check the bypass cable connection.
Bypass mode	The UPS is on bypass. This will clear when the UPS returns to Normal mode.
Bypass over-current	The load is drawing more current than the UPS is rated to supply in bypass mode. Reduce the load.
Charger fault	The charger output voltage is abnormal, and the charger is off. Contact Vertiv Technical Support.
Communication fails	Internal communication is abnormal. Check that the communication cables are connected correctly.
DC bus abnormal	The inverter is off due to DC bus voltage out of acceptable range. The load will transfer to bypass if the bypass is available because the bus voltage is outside of the acceptable range.
DC/DC fault	The discharger is faulty, because the bus voltage exceeds the range when the discharger starts. Contact Vertiv Technical Support.
EOD turn off	The inverter is off due to EOD. Check the main power off state and recover the mains in time.
Fan fault	At least one fan is faulty. Check if the fan is blocked or the cable connection is loose.

Table 6.4 Alarm Messages (continued)

Message	Description
Faults cleared	The faults have been cleared using Settings > Controls > Clear faults. This will display in the log whenever the event occurs.
Guaranteed shutdown	The battery has finished discharging, then system shuts down because Guaranteed Shutdown is enabled (see Guaranteed shutdown on page 35). This alarm will clear when the UPS is turned on again.
Input abnormal	The rectifier and charger are off due to the mains voltage and frequency exceeding normal range. Check if the input voltage and frequency are within the normal range or if the mains input has gone down.
Input ground lost	Check that the PE line is well connected and that the alarm can be cleared at the display.
Input neutral lost	The mains input neutral is not detected. The alarm will clear when the neutral connection has been restored.
Input phase reversed	The mains input line and neutral are reversed. Shut off external input breaker and connect the lines correctly.
Insufficient capacity to start	The UPS is on bypass and is started with a load greater than 105% of the rated capacity. Reduce the load to the rated capacity or below to start the unit.
Inverter fault	The inverter is turned off when the inverter output voltage or current exceed the ranges set. If bypass is available, the UPS will transfer to bypass mode, otherwise the system will power off. Contact Vertiv Technical Support.
Inverter overload	Inverter load capacity is larger than the rated value, overload delay time is up, inverter shuts down. If bypass is available, the system will transfer to the bypass mode, otherwise the system will power off. Check the output load. If overloaded, reduce the load, and the system will transfer to the inverter mode after five seconds with no alarm.
Inverter relay welded	The inverter relay is shorted. Contact Vertiv Technical Support.
Load off due to output short	A short has occurred on the output. Check the output cables and for any equipment that may have shorted.
Load off due to shutdown on battery	The system was shutdown in battery mode. This will clear when the system is turned back on.
Manual power- on	The system was turned on via the display panel. This will display in the log whenever the event occurs.
Manual shutdown	The system was shutdown via the display panel. This will display in the log whenever the event occurs.
No battery	No battery detected. Check the battery and battery cable connections.
On maintenance bypass	The UPS is operating in maintenance bypass mode. This will display in the log whenever the event occurs.
Operating on inverter	The UPS output is being powered by the inverter. This will display in the log whenever the event occurs.
Output disabled	The system is in standby state, and the dry contact shutdown is enabled. Check if the shutdown dry contact is enabled.
Output off due to bypass abnormal	The bypass voltage or frequency is outside the acceptable range, and the bypass is in stand-by mode. Check that the input is normal.
Output off due to overload & bypass abnormal	The output is off due to an overload of the UPS output, and the bypass voltage or frequency is outside the acceptable range. Check that the input is normal.
Output off, voltage is not zero	This occurs when the output is off and the system detects that there is still voltage on the output. Check output equipment for back feeds or contact Vertiv Technical Support.
Output pending	Remote shutdown has been initiated, and the system will turn off shortly.

Table 6.4 Alarm Messages (continued)

Message	Description
Output short	A short has occurred on the output. Check the output cables and for any equipment that may have shorted.
Rectifier fault	The rectifier is off because the bus voltage is out of the acceptable range when the rectifier starts. Contact Vertiv Technical Support.
Rectifier overload	The output power is larger than the rectifier overload point. Check that the input voltage meets the output load, if the mains input falls to 176 V - 100 V, the load is derated linearly from 100% - 50%.
Remote power- on	The UPS was powered on remotely. This will display in the log whenever the event occurs.
Remote shut- off	The UPS was powered off remotely. This will display in the log whenever the event occurs.
Remote shutdown	Any mode shutdown was initiated by the dry contact input. This will display in the log whenever the event occurs.
REPO	Shutdown caused by the REPO terminal Normally Closed contact input opening. This will display in the log whenever the event occurs.
Restore factory defaults	On the Maintenance page, <i>Restore Factory Defaults</i> has been set while the UPS is in the stand-by state. This will return settings to their factory settings.
Shutdown due to over temperature	During the UPS operation, the system checks if the heat sink temperature exceeds the setting range. If an overtemperature occurs, check if: <ul style="list-style-type: none"> • The ambient temperature is too high. • Dust is blocking any of the UPS vents. • A fan fault has occurred.
System over temperature	The internal heat-sink temperature is too high, and the inverter is off. The alarm can only be silenced if the heat-sink temperature is lower than the alarm setting. The system can automatically start after overtemperature fault is corrected. If an overtemperature occurs, check if: <ul style="list-style-type: none"> • The ambient temperature is too high. • Dust is blocking any of the UPS vents. • A fan fault has occurred.
Turn on fail	The UPS does not start because there is no mains/utility power or it is outside of the range of the voltage required to supply the full load. Check the AC input power.
UPS has no output	Both Inverter and Bypass are not supplying power due to the UPS output being turned off remotely or via the LCD or are unavailable due to no input power or input power out of range. Check that UPS is on and input power is available.

6.2.7 About Screen

The About screen offers tabs that list information about the product.

- Product tab — Displays UPS identification information, firmware versions, and information about the communication card.
- Efficiency tab — Displays the efficiency curve of the UPS vs the load, output load percentage, and efficiency at that load percentage.
- BMS FW Version—Displays the firmware version for the connected EBCs.
- BMS SN — Displays the serial number for the connected EBCs.

To view the product, efficiency, and battery age information:

1. At the main menu, select the About icon, and press **Enter**.
2. Use the arrow buttons to move the cursor left/right and select a tab, then press **Enter** to display the information for the selected tab.

Figure 6.8 About Screen Tabs

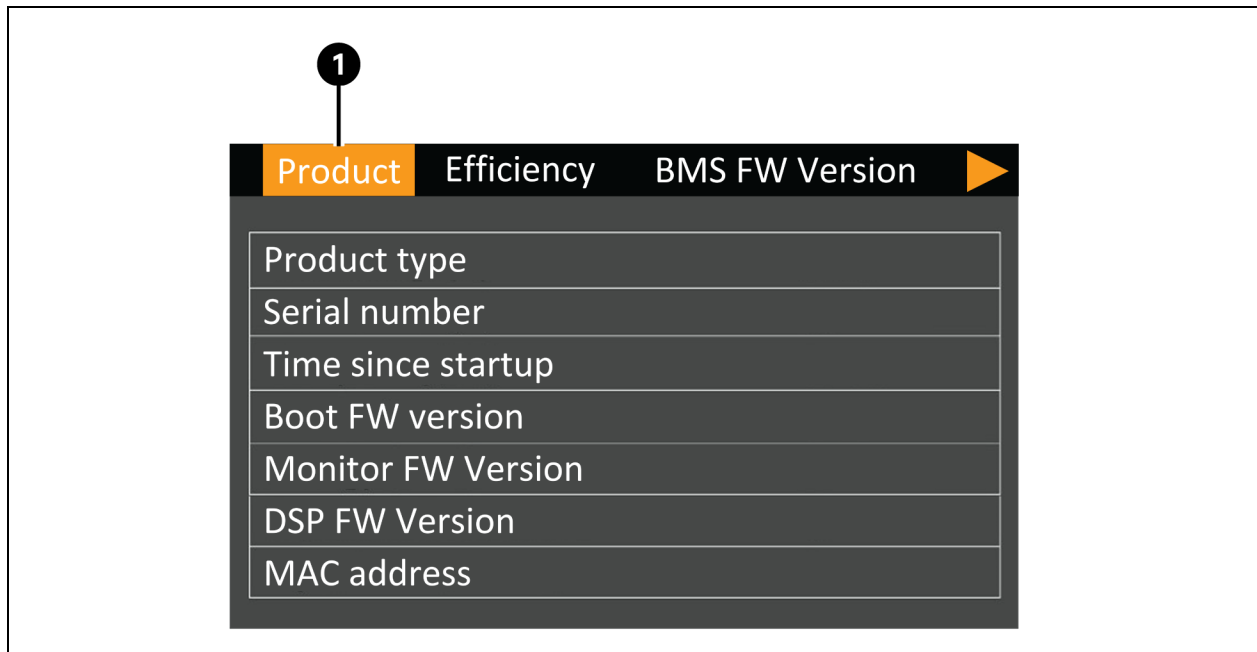

Item	Description
1	About screen tabs with Product tab selected. NOTE: The tab shown in the figure is an example and may not represent the actual information for your UPS model.

Product

- **Product Type:** UPS model number.
- **Serial number:** UPS serial number.
- **Time since startup:** Elapsed time since startup of the UPS.
- **Boot FW version:** Version of MCU boot firmware on the monitor board.
- **Monitor FW version:** Version of MCU application firmware on the monitor board.
- **DSP FW version:** Version of DSP firmware on the UPS power module.
- **MAC address:** Shows the MAC address of the RDU101 card. This is only shown when the RDU101 card is installed.
- **IPv4 address:** Shows the IPv4 address of the RDU101 card. This is only shown when the RDU101 card is installed.
- **Subnet mask:** Shows the subnet mask of the RDU101 card. This is only shown when the RDU101 card is installed.
- **Gateway address:** Shows the gateway address of the RDU101 card. This is only shown when the RDU101 card is installed.

Efficiency

- **Capacity:** This shows the maximum capacity of the UPS model.
- **Load (%):** This shows the percentage of the maximum capacity the UPS is currently using.
- **Eff. (%):** This shows the efficiency the UPS is currently operating at based on the Load (%) value.

BMS FW Version

- **Lithium Battery#:** Displays the battery firmware version for each connected EBC.

BMS SN

- **Lithium Battery#:** Displays the serial number for each connected EBC.

6.3 Editing Display and Operation Settings

You may adjust the display settings and UPS configuration via the LCD. The display and operation settings are password protected. The default password is 111111 (six ones).

NOTE: We recommend that you change the password to protect your system and equipment and record the new password and store it in an accessible location for later retrieval, see [Changing the Password on the facing page](#).

To enter the password:

1. Press the **Up** arrow button to change the digit shown, then press the **Down** arrow button to move to the next digit.
2. Repeat to select each digit, and press **Enter** to submit the password.

Figure 6.9 Password Prompt

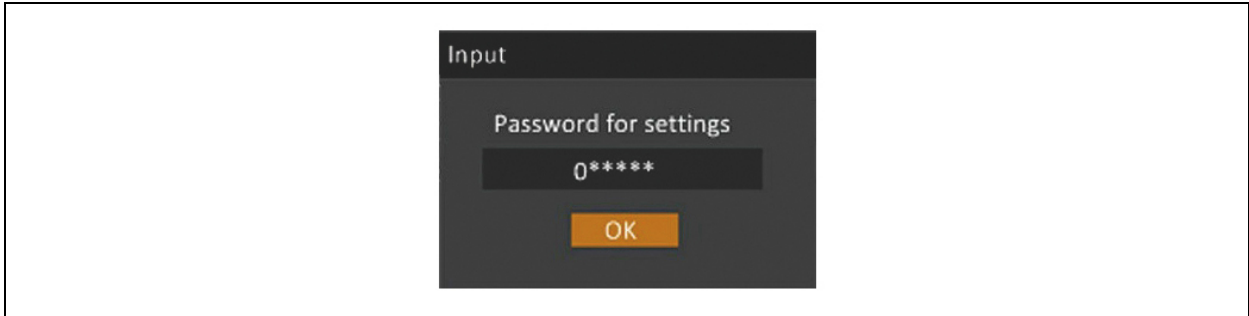

6.3.1 Settings Prompts

While using the operation and display panel, prompts display to alert you to specific conditions or require confirmation of commands or settings. **Table 6.5** below lists the prompts and their meaning.

Table 6.5 Display Prompts and Meanings

Prompt	Meaning
Cannot set this online, please shutdown output	Appears when changing important output settings (output voltage, output frequency, output phase No.).
Incorrect password, please input again	Appears when the Settings password is input incorrectly.
Operation failed, condition is not met	Appears when attempting to execute an operation for which the required conditions are not met.
Password changed OK	Appears upon successful change of the Settings password.
Fail to change password, please try again	Appears when attempting to change the Settings password but the new and confirmation passwords do not match.

Table 6.5 Display Prompts and Meanings (continued)

Prompt	Meaning
The time cannot be earlier than system time	Appears when attempting to set the time of <i>Turn on delay</i> or <i>Turn off delay</i> earlier than the current system time.
Turn on failed, condition is not met	Appears when proper conditions are not met for UPS power-on. Applies when using the power button or when execute the command of 'Turn on/Turn off/to Bypass' on the LCD panel 'Control' page).
Cannot set this on line, please unplug REPO	Appears when attempting to change the output phase number while the output is connected.

6.3.2 Changing the Password

The default password is 111111 (six ones). You must use the current password to change the password.

NOTE: We recommend that you change the password from the default to protect your system and equipment. Record the new password and store it in an accessible location for later retrieval.

1. At the main menu, select the *Settings* icon, and press **Enter**.
2. At the password prompt, use the **UP** arrow to select the first digit, press the **Down** arrow to move to the next digit, repeat for each digit, then press **Enter** to access the settings.
3. Use the arrow buttons to select the *Monitor* tab, then press **Enter**.
4. Use the **down** arrow to highlight *Change Settings Password*, press **Enter**, and re-enter the current password.

The *Input new password* dialog opens, see **Figure 6.10** below.

5. Enter the new password, then confirm the new password.

A confirmation dialog opens to indicate a successful password change.

6. Press **ESC** to return to the settings or main menu.

Figure 6.10 New and Confirm Password Dialogs

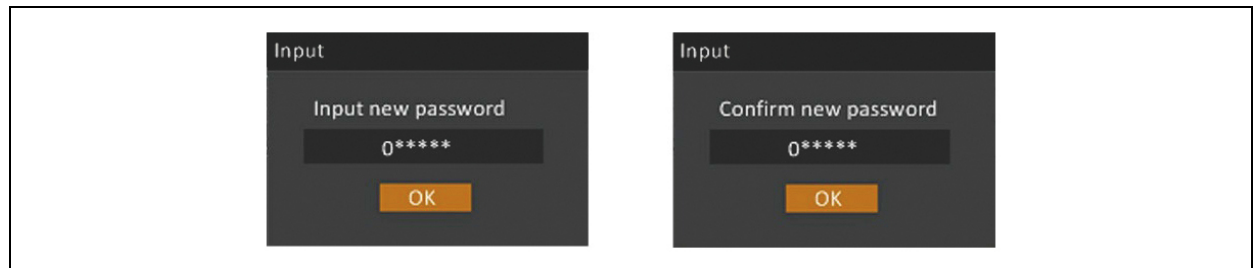

6.3.3 Selecting the Display Language

The LCD is multilingual. The available languages are listed below.

- English
- Français (French)
- Português (Portuguese)
- Español (Spanish)
- 中文 (Chinese)
- Deutsch (German)
- 日本語 (Japanese)
- Русский (Russian)
- čeština (Czech)
- Italiano (Italian)

To change the language:

1. At the main menu, select the *Settings* icon, and press **Enter**.
2. At the password prompt, use the **Up** arrow to select the first digit, press the **Down** arrow to move to the next digit, repeat for each digit, then press **Enter** to access the settings.
3. Use the arrow buttons to select the *Monitor* tab, then press **Enter**.
4. Use the **Down** arrow to highlight *Language*, then press **Enter**.
5. Use the **Up/Down** arrows to select the language, then press **Enter**.

All the LCD elements will now display in the selected language.

6.3.4 Setting the Date and Time

To adjust the date and time:

1. At the main menu, select the *Settings* icon, and press **Enter**.
2. At the password prompt, use the **Up** arrow to select the first digit, press the **Down** arrow to move to the next digit, repeat for each digit, then press **Enter** to access the settings.
3. Use the arrow buttons to select the *Monitor* tab, then press **Enter**.
4. Use the **Down** arrow to highlight *Date* or *Time*, then press **Enter**.
5. Use the **Up/Down** arrows to select the date/time, then press **Enter** to confirm.
6. Use the **Down** arrow to select the digit to change and the **Up** arrow to select the correct digit. Repeat as needed to set each digit.

7 Maintenance



WARNING! Risk of electric shock.

Can cause injury or death. Hazardous mains and/or battery voltage exists behind the protective cover. No user accessible parts are located behind the protective covers that require a tool for removal. Only qualified service personnel are authorized to remove such covers. If maintenance for UPS is needed, notice that the neutral line is live.

Observe the following precautions when working on batteries:

- Remove watches, rings, and other metal objects.
- Use tools with insulated handles.
- Wear rubber gloves and boots.
- Do not lay tools or metal parts on top of batteries.
- Disconnect input power prior to connecting or disconnecting battery terminals.
- If the battery kit is damaged in any way or shows signs of leakage, contact your Vertiv representative immediately.
- Handle, transport, and recycle batteries in accordance with local regulations.
- Determine if the battery is inadvertently grounded. If it is, remove the source of the ground. Contact with any part of a grounded battery can result in electrical shock. The likelihood of such shock will be reduced if grounds are removed during installation and maintenance.

7.1 Replacing Batteries



WARNING! Risk of electric shock.

Can cause injury or death. Disconnect all local and remote electric power supplies before working with the UPS. Ensure that the unit is shutdown and power has been disconnected before beginning any maintenance.



WARNING! Risk of electric shock and explosion.

Can cause equipment damage, injury and death. Do not dispose of the battery in a fire. The battery may explode. Do not open or damage the battery. Released electrolytes are toxic and harmful to skin and eyes. If electrolyte come into contact with the skin, wash the affected area immediately with plenty of clean water and get medical attention.



WARNING! Risk of electric shock.

Can cause equipment damage, injury and death. A battery can present a risk of electrical shock and high short-circuit current.



WARNING! Risk of explosion.
Can cause equipment damage, injury and death. A battery can explode if the battery is replaced by an incorrect type. Dispose of used batteries according to the instructions included with the battery pack.

Read all safety cautions before proceeding. A trained user can replace the EBC when the UPS is in a restricted access location (such as a rack or server closet). To obtain the appropriate replacement battery packs, refer to [Maintenance](#) on the previous page, and contact your local dealer or Vertiv representative.

Table 7.1 Replacement Battery Pack Model Numbers

UPS Model	Minimum Number of EBCs Required	Maximum Number of EBCs	EBC Model
GXT5LI-5KL630RT3UXLN	1	8	VEBCLI-192VRT1U
GXT5LI-5000GVRT3UXLN			
GXT5LI-6000GVRT3UXLN			
GXT5LI-8000GVRT3UXLN			
GXT5LI-10KGVRT3UXLN			

To replace an EBC refer to the steps below and **Figure 7.1** on the facing page.

NOTE: The EBC is hot-swappable. However, you must exercise caution because; during this procedure, the load is unprotected from disturbances and power outages. Do not replace the battery while the UPS is operating in Battery Mode. This will result in a loss of output power and will drop the connected load.

1. Open the EBC circuit breaker by switching it to the OFF position.
2. Disconnect any communication cables from the EBC COM ports.
3. Disconnect any CAN communication cables from the EBC CAN ports.
4. Disconnect the battery power cable from Battery Port A and Battery Port B (if applicable) on the EBC.
5. Note the address of the EBC. The same address will need to be set on the replacement EBC.
6. Remove the EBC from the mounting location.
7. Unpack the replacement EBC, taking care not to damage the packaging to reuse when disposing of the old battery.
8. Confirm the new EBC part number matches **Table 7.1** above. If so, proceed to step 9. If not, stop and contact your Vertiv representative, or Technical Support at <http://www.Vertiv.com/en-us/support/>.
9. Install the replacement EBC in the mounting location.
10. Reconnect the cables removed in steps 2 to 4, set the address noted in step 5, then close the battery circuit breaker by switching it to the ON position.

Figure 7.1 Replacing the EBC

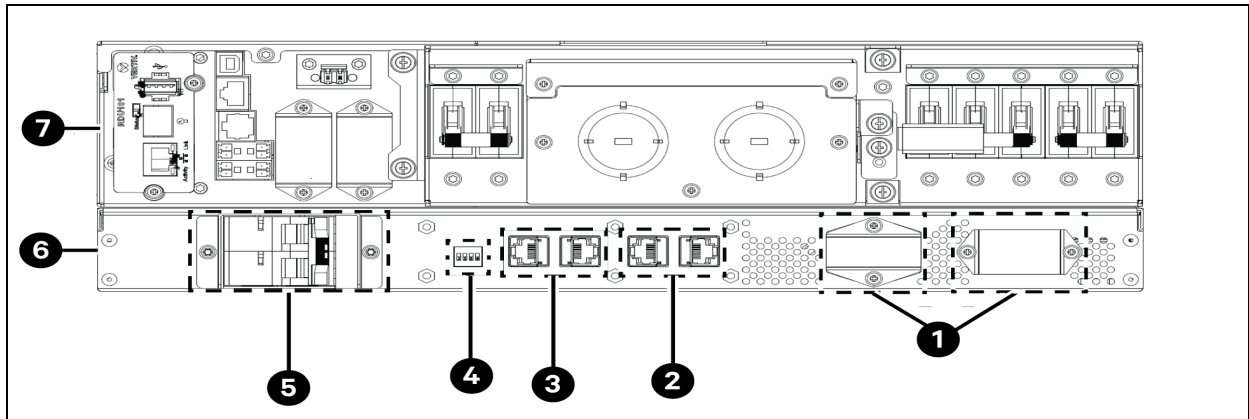

Item	Description
1	Battery Port A (left) and Port B (right)
2	CAN ports
3	COM ports
4	Address dip switches
5	EBC circuit breaker
6	EBC
7	UPS

7.2 Charging Batteries

The batteries are LiFePO₄ type Lithium-ion batteries. They should be kept charged to maintain their design life. The Vertiv™ Liebert® GXT5 Lithium-ion charges the batteries continuously when it is connected to input power. If the UPS will be stored for a long time, Vertiv recommends connecting the UPS to input power every 4 to 6 months for at least 3 hours to ensure recharge of the batteries.

The Lithium-ion batteries used in the Liebert® GXT5 Lithium-ion series, as well as all Vertiv Lithium-ion UPSs, contain a Battery Management System (BMS) that self-monitors the safety of the Lithium-ion batteries in real time. This is an agency tested and certified requirement now eliminating the industry wide safety risk known with previous Lithium-ion batteries.

7.3 Checking UPS Operation

NOTE: Operation check procedures may interrupt output power supplied to the connected load.

We recommend checking the UPS operation once every 6 months. Ensure that output power loss to the connected load will not cause data loss or other errors before conducting the check.

1. Press the **Enter** button to check the indicators and display function, see [Operation and Display Panel](#) on page 25.
2. Check for alarm or fault indicators on the operation/display panel.
3. Make sure that there are no audible or silenced alarms.
4. Select the Log, and check the Current and History tabs for current and previous alarm and fault, see [Log Screen](#) on page 38.
5. Check the flow screen to ensure the UPS is operating in Normal mode. If the UPS is expectedly operating in Bypass mode, contact Vertiv Technical Support.

7.4 Cleaning the UPS



WARNING! Risk of electric shock.

Can cause injury or death. Disconnect all local and remote electric power supplies before working with the UPS. Ensure that the unit is shutdown and power has been disconnected before beginning any maintenance.

The UPS requires no internal cleaning. If the outside of the UPS becomes dusty, wipe with a dry cloth. Do not use liquid or aerosol cleaners. Do not insert any objects into the ventilation holes or other openings in the UPS.

7.5 Firmware Updates

The UPS has three firmware components.

- DSP is the firmware for the power module.
- MCU is the firmware for the display panel.
- BMS is the firmware for the lithium-ion battery management system. This will appear for the internal battery and any connected EBCs.

All firmware components* may be updated using either CLI and the RS232 port, or the RJ-45 port on the RDU101 card, if installed.

*BMS firmware version 130 and under cannot be updated using the methods mentioned above. Contact your Vertiv representative or contact Technical Support at <https://www.vertiv.com/en-us/support/>.

The latest firmware files and update instructions are available for download under UPS Product Downloads on Vertiv's Software Downloads page at <https://www.vertiv.com/en-us/support/software-downloads/>.

8 Troubleshooting

This section indicates various UPS symptoms you may encounter and provides a troubleshooting guide in the event the UPS develops a problem. Use the following information to determine whether external factors caused the problem and how to remedy the situation.

8.1 Symptoms that Require Troubleshooting

The following symptoms indicate the UPS is malfunctioning.

- The relative indicators illuminate, indicating the UPS has detected a problem.
- An alarm buzzer sounds, alerting the user that the UPS requires attention.

8.2 Audible Alarm (Buzzer)

An audible alarm accompanies various events during UPS operations. Table 7.1 below, describes the sounds and their meaning. To silence an alarm, see [Silencing the Audible Alarm](#) on page 23.

Table 8.1 Audible Alarm Descriptions

Sound	Indicates
Continuous beep	Generated when a UPS fault appears, such as a fuse or hardware failure.
One beep every 0.5 seconds	Generated when a UPS critical alarm appears, such as on inverter overload.
One beep every 1 second	Generated when a UPS critical alarm appears, such as on battery low voltage.
One beep every 3.3 seconds	Generated when a UPS general alarm appears.

NOTE: When an alarm is indicated, an alarm message is logged. [Table 6.4](#) on page 39, describes the alarm messages you may see. When a fault is indicated, front panel display list the fault, which are described in [Table 8.2](#) below.

8.2.1 Faults

When the fault indicator is illuminated, the LCD displays the fault. The faults are described in [Table 8.2](#) below.

Table 8.2 Description of Displayed Faults

Displayed Fault	Cause	Corrective Steps
Battery test fail	The battery is bad or weak.	Contact technical support.
Rectifier fault	A rectifier failure occurred.	Contact technical support.
Inverter overload, Bypass overcurrent	The UPS is overloaded, Bypass is over current.	Reduce the load and contact technical support.
Inverter fault	The inverter is faulty.	Contact technical support.
Battery aged	The battery is bad or weak.	Replace the battery.
Output short	The output connection is short-circuited.	Shut-down the equipment and contact technical support.
DC bus fail	The DC bus is faulty.	Contact technical support.

Table 8.2 Description of Displayed Faults (continued)

Displayed Fault	Cause	Corrective Steps
System over temperature	Over temperature condition in the UPS. The UPS will transfer to bypass mode.	Reduce the load and contact technical support.
Charger fault	The charger is faulty.	Contact technical support.
Fan fault	At least one fan is faulty.	Contact technical support.
DC/DC fault	A DC-DC charger failure occurred.	Contact technical support.

8.3 Troubleshooting UPS Issues

In the event of an issue with the UPS, refer to **Table 8.3** below, to determine the cause and solution. If the fault persists, contact Vertiv Technical Support. Visit the GXT5 Lithium-ion product page at www.vertiv.com for contact information.

When reporting a UPS issue to Vertiv, include the UPS model and serial number. These are located in several places for your ease of location:

- On the top panel (rack mount orientation)
- The left side (tower orientation)
- The rear panel
- On the LCD select *Main Menu > About*

Table 8.3 Troubleshooting

Problem	Cause	Solution
UPS fails to start	UPS is short circuited or overloaded	Ensure UPS is off. Disconnect all loads and ensure nothing is lodged in the output receptacles. Ensure loads are not defective or shorted internally.
	Batteries are not charged enough or not connected	Check to ensure the EBCs is connected. If it is not, check all connections and try to start the unit. If the battery is connected, leave the UPS connected to input power for 4 hours to recharge batteries, then try to start the unit.
UPS has reduced battery backup time	Batteries are not fully charged	Keep UPS plugged in continuously at least 4 hours to recharge batteries.
	UPS is overloaded	Check load level indicator and reduce the load on the UPS.
	Batteries may not be able to hold a full charge due to age	Replace EBCs. Contact your Vertiv representative or Vertiv Technical Support for replacement battery kit.

9 Specifications

Table 9.1 UPS Specifications

MODEL: GXT5LI-	5KL630RT3UXLN	5000GVRT3UXLN	6000GVRT3UXLN	8000GVRT3UXLN	10KGVRT3UXLN
RATING	5000 VA/4400 W	5000 VA/5000 W	6000 VA/6000 W	8000 VA/8000 W	10000 VA/10000 W
Dimensions, D×W×H, in. (mm)					
Unit	34.1 × 16.9 × 3.3 (866 × 430 × 85) for 2U	35.6 × 16.9 × 3.3 (903 × 430 × 85) for 2U		36.6 × 16.9 × 3.3 (930 × 430 × 85) for 2U	
Shipping	39.4 × 31.5 × 22.0 (1000 × 800 × 560)				
Weight, lb.(kg)					
Unit	38 (17)	35 (16)		44 (20)	
Shipping	174 (79)	171 (78)		179 (81)	
Input AC					
Operating Frequency, Nom.	50 or 60 Hz (factory default is 50 Hz)				
Factory-default VAC	208 VAC	230 VAC			
User-configurable VAC	200/208/220/230/240 VAC (user-configurable)				
Input Circuit Breaker	30 A	50 A	60 A	70 A	
Input Frequency without Battery Operation	40 – 70 Hz				
Input Power Connection	L630-30P Plug	Hard-wired terminal block 2W+ G (L1-L2/N-G)			
Maximum Allowable VAC	288 VAC				
Output AC					
Factory-default VAC	208 VAC	230 VAC			
Output Circuit Breaker	30 A	50 A	60 A	70 A	
Operating Load Range	105% to 125% for 5 minutes 125% to 150% for 60 seconds >150% (impact load) minimum 200 ms				
Bypass Protection Limits					
Re-enable Bypass Operation	If input voltage returns to within ±10% nominal output voltage				
Disable Bypass Operation	When the input frequency prevents synchronous operation				
Battery Parameters					
Type	Lithium-ion (LiFePO ₄)				
Voltage, Number of LI Cells and Rating	EBC: 192V; 120 LI LFP Cells (2 packs of 60 cells in parallel, each cell rated at 3.2V)				
Backup Time	See Battery Run Times on page 55.				

Table 9.1 UPS Specifications (continued)

MODEL: GXT5LI-	5KL630RT3UXLN	5000GVRT3UXLN	6000GVRT3UXLN	8000GVRT3UXLN	10KGVRT3UXLN
RATING	5000 VA/4400 W	5000 VA/5000 W	6000 VA/6000 W	8000 VA/8000 W	10000 VA/10000 W
Recharge Time	2 hours to 90% capacity after full discharge at 100% load until UPS auto-shutdown				
Charger Current, A	3 A (default), maximum 5 A			3 A (default), maximum 8 A	
Environmental					
Operating Temperature, °F (°C)	32 to 104 (0 to 40) - no derating 104 to 122 (40 to 50) - derating				
Storage Temperature, °F (°C)	-4 to 140 (-20 to 60)				
Relative Humidity	0 – 95% non-condensing				
Operating Elevation	Up to 10,000 ft (3,000 m) at 77 °F (25 °C) without derating				
Audible Noise	<58 dB at 3.2 ft (1 m) from the front, sides, and rear				
Agency					
Safety	UL1778, cTUVus	UL1778, cTUVus, CB, CE			
RFI/EMI	FCC Part 15 (Class A)	IEC/EN 62040-2 C2, FCC Part 15 (Class A)			
Surge Immunity	IEEE/ANSI C62.41 Category B (6kV/3kA)				
Transportation	ISTA Procedure 3E, UN38.3 (for lithium battery)				

Table 9.2 EBC Specifications

Model	VEBCLI-192VRT1U				
Used With UPS Model GXT5LI-	5KL630RT3UXLN	5000GVRT3UXLN	6000GVRT3UXLN	8000GVRT3UXLN	10KGVRT3UXLN
Dimensions, W×D×H, inches (mm)					
Unit	16.9 x 30.7 x 1.67 (430 x 780 x 42.5) for 1U				
Shipping	31.4 x 39.3 x 11.2 (800 x 1000 x 285)				
Weight, lb. (kg)					
Unit	48.5 (22)				
Shipping	106.9 (48.5)				
Battery					
Type	Lithium-ion (LiFePO ₄)				
Voltage, Number of LI Cells and Rating	EBC: 192V; 120 LI LFP Cells (2 packs of 60 cells in parallel, each cell rated at 3.2V)				
Backup Time	See Battery Run Times on the facing page .				
Environmental Requirements					
Operating Temperature, °F (°C)	32 to 104 (0 to 40)				

Table 9.2 EBC Specifications (continued)

Model	VEBCLI-192VRT1U				
Used With UPS Model GXT5LI-	5KL630RT3UXLN	5000GVRT3UXLN	6000GVRT3UXLN	8000GVRT3UXLN	10KGVRT3UXLN
Storage Temperature, °F (°C)	-4 to 140 (-20 to 60)				
Relative Humidity	0% to 95%, non-condensing				
Operating Elevation	Up to 10,000 ft (3,000 m) at 104 °F (40 °C)				
Agency					
Safety	Cell: UL1642 BMS: UL60730-1 Cabinet: UL&CUL1973				
RFI/EMI	FCC Part 15 Class A				
Surge Immunity	IEEE/ANSI C62.41 Category B				
Transportation	ISTA Procedure 3E UN38.3				

9.1 Battery Run Times

NOTE: Run times in this table are approximate. They are based on new, fully charged batteries at 77 °F (25 °C), with fully resistive loads. Run times can vary ±5% due to manufacturing variances.

Table 9.3 Battery Run Times in Minutes, GXT5LI-5KL630RT3UXLN and GXT5LI-5000GVRT3UXLN

Load			Number of EBCs							
			1	2	3	4	5	6	7	8
%	VA	W	Minutes							
10	500	500	107	215.5	324	432.5	541.5	650	758.5	867
20	1000	1000	56	114.5	173	231	289.5	347.5	406	464
30	1500	1500	38.5	78.5	119.5	159.5	200	240.5	280.5	321
40	2000	2000	30.5	60	91.5	123	154	185.5	216.5	248
50	2500	2500	25	48.5	74	99.5	125	150	175.5	201
60	3000	3000	20.5	40	61	82.5	104	125	146	167.5
70	3500	3500	17.5	34.5	52	70	88.5	107	125	143
80	4000	4000	15	31	45.5	61	77	93	109	125
90	4500	4500	12.5	28	40	54	68	82.5	96.5	111
100	5000	5000	10.5	25	36	48	61	73.5	86.5	99.5

Table 9.4 Battery Run Times in Minutes, GXT5LI-6000GVRT3UXLN

Load			Number of EBCs							
			1	2	3	4	5	6	7	8
%	VA	W	Minutes							
10	600	600	90.5	183	275	367.5	459.5	552	644.5	736.5
20	1200	1200	47	97	146.5	195.5	245	294.5	343.5	393
30	1800	1800	33.5	66	101	135.5	169.5	204	238	272.5
40	2400	2400	26	50.5	77	103.5	130	156.5	183	209.5
50	3000	3000	19	40	61	82.5	104	125	146	167.5
60	3600	3600	16.5	34.5	50.5	68	86	104	121.5	139
70	4200	4200	13	30	43	58	73	88.5	104	119
80	4800	4800	11	26	37.5	50	63.5	77	90	103.5
90	5400	5400	10	23	34	44	56	68	79.5	91.5
100	6000	6000	9	20.5	31	40	50	60.5	71.5	82

Table 9.5 Battery Run Times in Minutes, GXT5LI-8000GVRT3UXLN

Load			Number of EBCs							
			1	2	3	4	5	6	7	8
%	VA	W	Minutes							
10	800	800	64.5	131.5	198.5	265	332	398.5	465	532
20	1600	1600	34.5	70.5	107	143.5	179.5	215.5	252	288
30	2400	2400	22.5	49	75	101.5	127	153	178.5	204.5
40	3200	3200	16.5	36.5	55.5	75	94.5	114	133.5	152.5
50	4000	4000	14.5	30.5	44	59.5	75	90.5	106	121.5
60	4800	4800	11.5	25	36.5	49	61.5	74.5	87.5	100.5
70	5600	5600	9.5	21.5	32	41.5	52	63.5	74.5	85.5
80	6400	6400	8	18.5	28	36	45.5	54.5	64.5	74
90	7200	7200	7	16	25	33	40	48	56.5	65
100	8000	8000	5	14	22.5	29	36	43.0	50.5	58

Table 9.6 Battery Run Times in Minutes, GXT5LI-10KGVRT3UXLN

Load			Number of EBCs							
			1	2	3	4	5	6	7	8
%	VA	W	Minutes							
10	1000	1000	52	107.5	162	217	271.5	326	381	435.5
20	2000	2000	29.5	58	88.5	119	149	179	209	239.5
30	3000	3000	19	39	59.5	80.5	101.5	122	142.5	163
40	4000	4000	14.5	30.5	44	59.5	75	90.5	106	121.5
50	5000	5000	10.5	24	35	47	59	71.5	84	96.5
60	6000	6000	8.5	19.5	30	38.5	48.5	58.5	69	79.5
70	7000	7000	7	16.5	25.5	34	41	49.5	58.5	67
80	8000	8000	5	14	22.5	29	36	43	50.5	58
90	9000	9000	4	11.5	19.5	26.5	32.5	38	44.5	51
100	10000	10000	3.5	10.5	17.5	23.5	29.5	34.5	40	46

This page intentionally left blank

Appendices

Appendix A: Technical Support and Contacts

A.1 Technical Support/Service in the United States

Vertiv Group Corporation

24x7 dispatch of technicians for all products.

1-800-543-2378

Liebert® Thermal Management Products

1-800-543-2378

Liebert® Channel Products

1-800-222-5877

Liebert® AC and DC Power Products

1-800-543-2378

A.2 Locations

United States

Vertiv Headquarters

505 N Cleveland Ave

Westerville, OH 43082

Europe

Via Leonardo Da Vinci 8 Zona Industriale Tognana

35028 Piove Di Sacco (PD) Italy

Asia

7/F, Dah Sing Financial Centre

3108 Gloucester Road, Wanchai

Hong Kong

Appendix B: Open Source Software Legal Notices

The Vertiv™ Liebert® GXT5 Lithium-ion product links the Free RTOS software with Vertiv Group Corporation's proprietary modules that communicate with the Free RTOS software solely through the Free RTOS API interface. This use is an exception to the FOSS GPLv2 license. The user is free to redistribute the Free RTOS software and/or modify it under the terms of the GNU General Public License as published by the Free Software Foundation. A copy of the GNU General Public License is located at www.gnu.org/licenses/old-licenses/gpl-2.0.html. A copy of the exception is located at <https://spdx.org/licenses/freertos-exception-2.0.html>. For a period of three (3) years after purchasing the Liebert® GXT5 Lithium-ion product, the purchaser has the right to obtain a copy of the Free RTOS software that is incorporated in the Liebert® GXT5 Lithium-ion product.

The purchaser can contact Vertiv Technical Support and request the software.

Connect with Vertiv on Social Media



<https://www.facebook.com/vertiv/>



<https://www.instagram.com/vertiv/>



<https://www.linkedin.com/company/vertiv/>



<https://www.x.com/Vertiv/>



Vertiv.com | Vertiv Headquarters, 505 N Cleveland Ave, Westerville, OH 43082 USA

©2025 Vertiv Group Corp. All rights reserved. Vertiv™ and the Vertiv logo are trademarks or registered trademarks of Vertiv Group Corp. All other names and logos referred to are trade names, trademarks or registered trademarks of their respective owners. While every precaution has been taken to ensure accuracy and completeness here, Vertiv Group Corp. assumes no responsibility, and disclaims all liability, for damages resulting from use of this information or for any errors or omissions.

SL-71180_REVB_01-25