

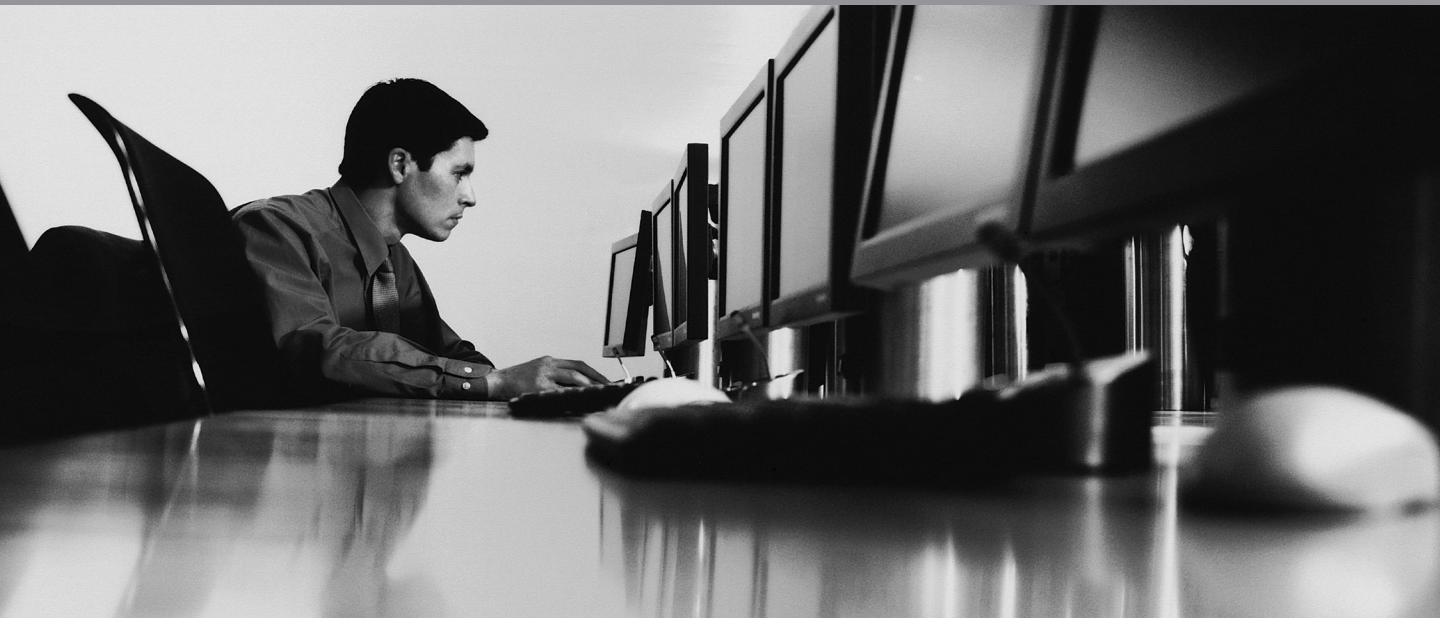

HMX EXTENDER SYSTEM

Installer/User Guide



USA Notification

WARNING: Changes or modifications to this unit not expressly approved by the party responsible for compliance could void the user's authority to operate the equipment.

NOTE: This equipment has been tested and found to comply with the limits for a Class A digital device, pursuant to Part 15 of the FCC Rules. These limits are designed to provide reasonable protection against harmful interference when the equipment is operated in a commercial environment. This equipment generates, uses and can radiate radio frequency energy and, if not installed and used in accordance with the instruction manual, may cause harmful interference to radio communications. Operation of this equipment in a residential area is likely to cause harmful interference in which case the user will be required to correct the interference at his own expense.

Canadian Notification

This digital apparatus does not exceed the Class A limits for radio noise emissions from digital apparatus set out in the Radio Interference Regulations of the Canadian Department of Communications.

Le présent appareil numérique n'émet pas de bruits radioélectriques dépassant les limites applicables aux appareils numériques de la classe A prescrites dans le Règlement sur le brouillage radioélectrique édicté par le Ministère des Communications du Canada.

Japanese Approvals

この装置は、情報処理装置等電波障害自主規制協議会（VCCI）の基準に基づくクラスA情報技術装置です。この装置を家庭環境で使用すると電波妨害を引き起こすことがあります。この場合には使用者が適切な対策を講ずるよう要求されることがあります。

Safety and EMC Approvals and Markings

UL, FCC, cUL, VCCI, CE, C-Tick Safety certifications and EMC certifications for this product are obtained under one or more of the following designations: CMN (Certification Model Number), MPN (Manufacturer's Part Number) or Sales Level Model designation. The designation that is referenced in the EMC and/or safety reports and certificates are printed on the label applied to this product. European Union Notification Warning: This is a class A product. In a domestic environment, this product may cause radio interference in which case the user may be required to take adequate measures.





HMX Extender System

Installer/User Guide

Avocent and the Avocent logo are registered trademarks of Avocent Corporation or its affiliates in the U.S. and other countries. All other marks are the property of their respective owners.

© 2010 Avocent Corporation. 590-821-501J



Instructions

This symbol is intended to alert the user to the presence of important operating and maintenance (servicing) instructions in the literature accompanying the appliance.



Dangerous Voltage

This symbol is intended to alert the user to the presence of uninsulated dangerous voltage within the product's enclosure that may be of sufficient magnitude to constitute a risk of electric shock to persons.



Power On

This symbol indicates the principal on/off switch is in the on position.



Power Off

This symbol indicates the principal on/off switch is in the off position.



Protective Grounding Terminal

This symbol indicates a terminal which must be connected to earth ground prior to making any other connections to the equipment.

TABLE OF CONTENTS

Chapter 1: Product Overview	1
<i>Introduction</i>	1
<i>HMX system features</i>	1
<i>Transmitter features</i>	3
<i>User station features</i>	4
<i>User station modes</i>	5
<i>Safety Precautions</i>	6
Chapter 2: Installation	9
<i>Installing the HMX 1050 User Station</i>	9
<i>Needed to install the HMX 1050 user station</i>	9
<i>Needed for non-standard installations</i>	9
<i>Mounting option</i>	9
<i>Installation options</i>	10
<i>Point-to-point installation</i>	10
<i>Connecting power</i>	14
<i>Networked installation</i>	14
<i>Installing the HMX 1070 and HMX 2050 User Stations</i>	17
<i>Needed to install the HMX 1070 or HMX 2050 user station</i>	17
<i>Needed for non-standard installations (HMX 2050 user station only)</i>	17
<i>Mounting option</i>	17
<i>Installation options</i>	17
<i>Connecting power</i>	20
<i>Networked installation</i>	21
Chapter 3: Operations	25
<i>Overview</i>	25
<i>LED identification</i>	25
<i>Accessing the System</i>	26
<i>OSD functions</i>	26
<i>Displaying system information using the OSD</i>	26
<i>Configuring networking parameters using the OSD</i>	29
<i>Setting the OSD timeout</i>	29
<i>Setting the Auto Logout time-out</i>	30

<i>Access through Auto-Login Mode</i>	31
<i>The Serial Menu</i>	32
<i>Accessing the serial menu</i>	32
<i>Navigating the serial menu</i>	33
<i>Configuring Network Settings</i>	33
<i>Detecting a transmitter IP address</i>	40
<i>Authentication</i>	42
<i>Flash Upgrading your HMX System</i>	45
<i>Restoring Factory Default Settings</i>	48
<i>Resetting the HMX System</i>	48
<i>Viewing System Information</i>	49
<i>Configuring Video Input Settings</i>	51
<i>Preferred monitor resolutions (EDID preferred timing)</i>	52
<i>Session retry settings</i>	53
<i>Configuring the OSD Hotkey Sequence</i>	54
<i>OSD Inactivity Time-out</i>	56
<i>Audio Performance Settings</i>	57
<i>Display power saving mode</i>	59
<i>Setting the Auto Logout Timeout (Serial Menu)</i>	59
Chapter 4: Share Mode	61
<i>Using Share Mode</i>	61
<i>Using a USB device with Share Mode</i>	61
<i>Using Share Mode in Desktop Mode</i>	62
<i>Using Share Mode in Extender Mode</i>	63
Chapter 5: Advanced Operations	65
Appendices	69
<i>Appendix A: Technical Specifications</i>	69
<i>Appendix B: Factory Default Settings</i>	80
<i>Appendix C: Technical Support</i>	82
<i>Appendix D: Troubleshooting</i>	83
<i>Appendix E: Login Error Messages</i>	87
License Information	89

Product Overview

Introduction

The HMX extender system, which includes a transmitter and a user station, provides users with a full workstation desktop experience from anywhere on the corporate TCP/IP network, while maintaining the workstations securely housed in a corporate data center. Desktop users can access keyboard, mouse, video, audio, USB mass storage devices and other USB devices from remote workstations via the HMX system. Virtual USB support is also featured in the HMX system.

NOTE: References to the HMX system in this document refer to both the user station (HMX 1050, HMX 1070 or HMX 2050 user stations) and the transmitter. The HMIQDI transmitter accompanies the HMX 1050 user station, the HMIQSHDI transmitter accompanies the HMX 1070 user station and the HMIQDHDD transmitter accompanies the HMX 2050 user station. See *Transmitter features* on page 3 for more information.

HMX system features

The HMX extender system contains the following features.

NOTE: This product contains certain free and/or open source components. To request an open source software kit for the open source components used in this product, please complete a FOSS Request Form at http://www.avocent.com/x_For_The_User/Policies/Open_Source_Policy.aspx.

Security

The HMX system supports Secure Sockets Layer (SSL) over a TCP/IP connection. All media streams transmitted between the HMX user station and the transmitter are encrypted. Password protection is also provided to control access to all administration functions.

Flash upgradable

Upgrade your firmware at any time using the XMODEM or HTTP protocols to ensure that your HMX system is always running the most current version available. Both the transmitter and the HMX user station are Flash upgradable. Upgrades can also be performed via the HMX Manager. See the HMX Manager Installer/User Guide for more information.

Ethernet addressing

The HMX user station and the transmitter are IP-addressable devices, giving you the flexibility to locate workstations anywhere within your enterprise and at any distance from your desktop users. The HMX user station and transmitter use standard network protocols to transfer data between the remote workstation and the peripheral devices located at the user's desk. The HMX user station can operate on a network connection of 100 Mbps or 1 Gbps. For optimum performance, a 1 Gbps connection is recommended.

Support for keyboards, mice and mass storage devices

USB and PS/2 keyboards (up to 109 keys) and mice are fully supported by the HMX system. The remote workstation default keyboard and mouse drivers are fully supported, enabling the HMX system to support two, three and five-button mice with scroll and tilt-wheel capability. Composite mouse and keyboard devices are also supported, along with mass storage devices and other types of USB devices. CD and DVD-ROM drives, thumb drives and other non-isochronous USB devices such as printers, touch screens, smart card readers, and pen tablets are supported as well.

NOTE: The HMX system does not support isochronous USB devices such as speakers or web cams.

Support for mass storage devices is also provided on the HMX user stations automatically. Support for other USB devices is provided on the HMX 1070 and HMX 2050 user stations automatically, but can be overridden by the user. In an HMX user station, the first device that is not keyboard, mouse or mass storage is assigned to the virtual USB channel (vUSB channel) and passed to the remote computer. In the event you want to use the vUSB channel for a keyboard or mouse, the on-screen display (OSD) allows the default vUSB device to be disabled and a keyboard or mouse to be assigned to that vUSB channel.

NOTE: The vUSB channel will only be used for devices other than the standard keyboard, mouse and mass storage devices.

A firmware upgrade is required to utilize mass storage instead of another vUSB device on the HMX 1050 user station. Default support for other USB devices in the HMX 1050 user stations is provided in place of support for a mass storage device. If you need to use mass storage in place of another vUSB device, go to www.avocent.com and download the HMX 1050 user station firmware upgrade.

NOTE: A hub cannot be used to expand the number of USB ports available.

The HMIQDI transmitter provides two USB interfaces:

- One port is low speed while the second video port is set to full speed. These ports are used for all keyboard and mouse peripheral devices interfacing with the target workstation, along with providing power for the HMIQDI transmitter.

- The other is a high-speed port that is used for virtual media (mass storage devices) peripheral devices or other USB devices interfacing with the target workstation, along with providing power for the HMIQDI transmitter.

NOTE: The HMIQDHDD and HMIQSHDI transmitters provide a single USB interface, and use an integrated hub within the transmitter.

Video

Video of 24-bit color depth up to a resolution of 1280 x 1024 at 60 Hz is supported by the HMX 1050 user station and HMIQDI transmitter. Both CRT and flat-panel LCD monitors are supported, and can be connected to the HMX system via a DVI-I video connector. VGA monitors can be attached to the system by using a DVI to VGA adaptor. The system supports DDC version 2B.

The HMX 1070 user station and HMIQSHDI transmitter support 24-bit color depth up to a resolution of 1920 x 1200 at 60 Hz. Both DVI-D and VGA video sources are supported at the transmitter via a dual connector, allowing the user to choose the appropriate video source.

The HMX 2050 user station and HMIQDHDD transmitter also support 24-bit color depth up to a resolution of 1920 x 1200 at 60 Hz. DVI-D computer video sources are supported at the transmitter. Since DVI-I is supported at the user station, a VGA adaptor can be used to connect to a VGA monitor.

Both the HMX 1070 and HMX 2050 user stations feature support for 1680 x 1050 at 60 Hz.

Transmitter features

The transmitter connects externally to the video, audio and USB ports of the remote workstation.

The HMIQDI transmitter is attached directly to the remote workstation and draws its power directly from two USB ports on the remote workstation. The HMIQDHDD and HMIQSHDI transmitters are powered by an external power supply.

The transmitter captures, compresses and encrypts the workstation's media streams and transmits them to the user station over a standard TCP/IP network.

Interoperability

The HMIQSHDI and HMIQDHDD transmitters are compatible with each other, enabling users with combined single and dual video computers to gain access from either a single or dual display desks.

NOTE: The HMX 1070 and HMX 2050 user stations will only show a single, A channel video of the HMIQSHDI and HMIQDHDD transmitters, respectively.

Multiplatform support

The transmitter is connected to the remote workstation via USB connectors. This enables the HMX user station to interoperate seamlessly with PC, Sun[®] and Macintosh[®] workstations. PS/2 keyboards and mice can also be used.

Screen aspect ratio

The transmitter can be configured through the serial console to allow either normal aspect resolutions or wide screen resolutions as preferred settings.

User station features

The HMX user station enables the desktop user's peripherals to connect to the target workstation via a network connection to the transmitter directly connected to the target workstation.

Multiplatform support

HMX user stations are compatible with the following operating systems:

- Microsoft® Windows®
- Linux®
- Solaris™
- Microsoft Windows Vista®
- Mac OS®

The default keyboard drivers for these operating systems are supported by the HMX user station.

Flexible installation

The HMX user station provides you with the following flexible installation features:

- The HMX user station can be desk mounted or mounted on the back of a monitor
- Installation requires no new drivers or software
- Standard UTP cabling makes installation simple and keeps costs low

On-Screen Display (OSD)

The HMX user station includes an OSD that allows you to view information about the configuration of your system.

Operations administration and maintenance

The HMX user station incorporates a serial menu that allows you to perform administration and maintenance tasks for both the HMX user station and the transmitter. Examples of tasks you can perform include configuration of network settings and firmware Flash upgrades.

Virtual media

Mass storage devices, such as removable drives and external CD-ROM drives, can be attached to the HMX user station and will function as if they are directly connected to the remote workstation. You can connect both a removable drive and an external drive to an HMX user station.

The transfer speed between the mass storage device and the remote workstation is dependant on the Ethernet network. The system can operate over a 100 Mbps Ethernet connection. A 1 Gbps connection is required for high-performance virtual media transfer.

NOTE: Hot-plugging of USB mass storage devices is supported.

Audio

The HMX system supports CD-quality stereo from the remote workstation to peripheral speakers, while the HMX 1050 user station also supports mono-quality audio from a peripheral microphone to the remote workstation.

Bandwidth usage (HMX 1050 user station only)

It is possible to restrict the aggregate bandwidth used on the Ethernet link from the serial console. The bandwidth options are:

- Unlimited
- 100 MBits/s
- 50 MBits/s
- 20 MBits/s
- 10 MBits/s

User station modes

The HMX system can operate in Extender Mode, Desktop Mode, Matrix Mode or Share Mode. The HMX user station and transmitter can obtain their IP address data from a DHCP server in any of the three modes.

Extender Mode

In Extender Mode, turning on the HMX user station automatically establishes a connection with the remote workstation via the transmitter.

Desktop Mode

In Desktop Mode, turning on the HMX user station enables the user to log in and connect to their allocated computer.

Matrix Mode

In Matrix Mode, turning on the HMX user station enables the user to log in and view all accessible computers.

Share Mode

In Share Mode, multiple users can connect to the audio and video of a target computer over the network and arbitrate for control of that computer.

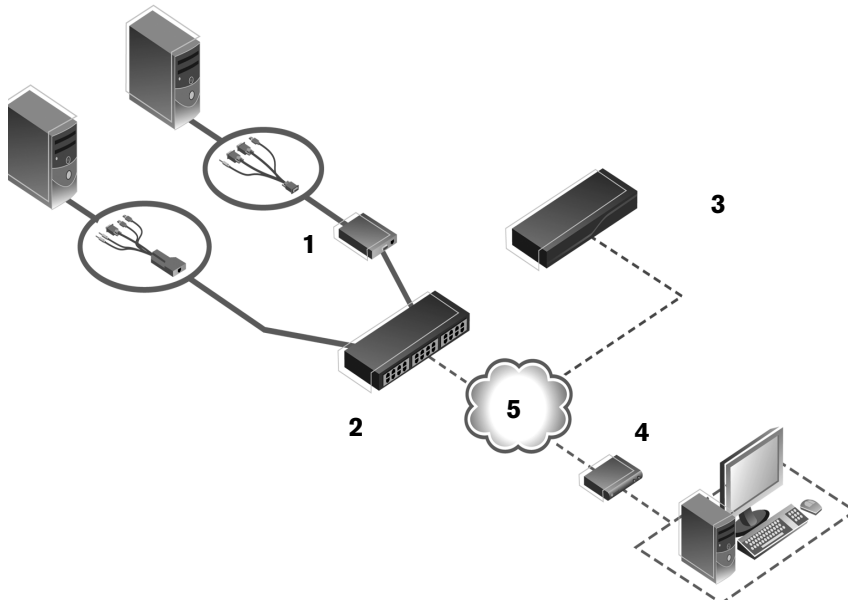

Figure 1.1: HMX Workstation Extension System - Desktop Mode

Table 1.1: Figure 1.1 Descriptions

Number	Description
1	Transmitters (HMIQDI and HMIQDHDD transmitters shown)
2	Gigabit Ethernet Switch
3	HMX Manager
4	User Station
5	Ethernet LAN

Safety Precautions

To avoid potential video and/or keyboard problems when using Avocent products:

- If the building has 3-phase AC power, ensure that the workstation and monitor are on the same phase. For best results, they should be on the same circuit.

To avoid potentially fatal shock hazard and possible damage to equipment, please observe the following precautions:

- Do not use a 2-wire extension cord in any Avocent product configuration.
- Test AC outlets at the workstation and monitor for proper polarity and grounding.
- Use only with grounded outlets at both the workstation and monitor. When using a backup Uninterruptible Power Supply (UPS), power the workstation and the transmitter off the same supply.

NOTE: The AC inlet is the main disconnect.

Installing the HMX 1050 User Station

Before installing your HMX 1050 user station, refer to the list below to ensure that you have all the items necessary for installation.

NOTE: For installation of the HMX Manager, see the HMX Manager Installer/User Guide.

Needed to install the HMX 1050 user station

- HMIQDI transmitter (ordered separately)
- External power supply for the HMX 1050 user station
- IEC power cord
- HMX 1050 User Station Quick Installation Guide
- Three-wire serial cable or null modem cable (not supplied)

Needed for non-standard installations

- To connect a VGA monitor to the HMX 1050 user station: a DVI to VGA adaptor (not supplied)
- To connect the HMIQDI transmitter to a remote workstation that has VGA video output: a VGA to DVI-I adaptor (not supplied)
- To connect the HMIQDI transmitter to a remote workstation that has DVI-D video output: a DVI-D to DVI-I adaptor (not supplied)
- If the remote workstation is unable to supply sufficient power to support the HMIQDI transmitter: an optional power supply, available from Avocent

Mounting option

The HMX 1050 user station mounts to the rear of a flat panel monitor via a mounting plate accessory.

NOTE: Mounting accessories for user station and transmitters are ordered separately. Contact Avocent for more information.

Installation options



CAUTION: To reduce the risk of electric shock or damage to your equipment, disconnect the power from the HMX 1050 user station by unplugging the power supply from the electrical outlet. To reduce the risk of electric shock or damage to your equipment, turn on the remote workstation and the HMX 1050 user station in the order described in the following procedures.

You can install the HMX system with the HMX 1050 user station either by a point-to-point or networked configuration.

Point-to-point installation

In a point-to-point configuration, no administrator setup of the HMIQDI transmitter or the HMX 1050 user station is required. This enables you to install the system quickly, directly out-of-the-box. However, in the point-to-point configuration, you can install only one HMIQDI transmitter and HMX 1050 user station pair on a subnet, and both must be on the same subnet.

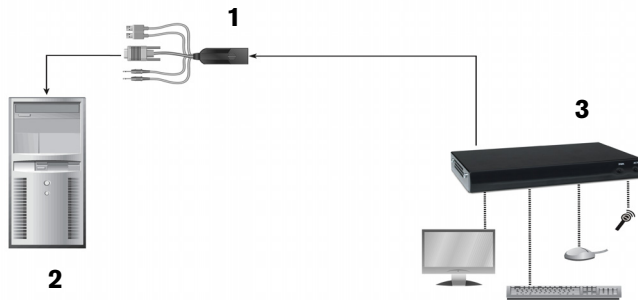

Figure 2.1: Point-to-Point Installation (HMX 1050 User Station)

Table 2.1: Figure 2.1 Descriptions

Number	Description
1	HMIQDI Transmitter
2	Remote Workstation
3	HMX 1050 User Station

To connect the HMIQDI transmitter:

Before connecting the HMIQDI transmitter to the remote workstation, ensure that the resolution and the refresh rate of the remote workstation are supported by the HMX 1050 user station. Set the screen resolution and refresh rate of the remote workstation. Unsupported settings will cause blank video at the user station.

NOTE: Go to www.avocent.com for updated information on supported resolutions and refresh rates.

1. Turn off the remote workstation.
2. The HMIQDI transmitter has two USB connectors. Connect each of these connectors to a corresponding USB port on the remote workstation.
3. Connect the video connector on the HMIQDI transmitter to the appropriately labeled port on the workstation.

NOTE: A VGA-only workstation can be connected to the HMIQDI transmitter using a VGA to DVI-I adaptor. You must configure the HMIQDI transmitter video settings for VGA through the serial menu.

4. Connect the HMIQDI transmitter's audio and microphone connectors to the appropriately labeled ports on the back of the workstation.

NOTE: For CD-quality audio, you must configure the HMIQDI transmitter and the user station using the serial menu.

5. Connect one end of the UTP cable to the HMIQDI transmitter's RJ-45 connector and turn on the workstation.
6. Route the other end of the UTP cable to the location you have chosen for the HMX 1050 user station. If necessary, you can extend the UTP cable via junctions or a hub (subject to normal Ethernet cabling practices).

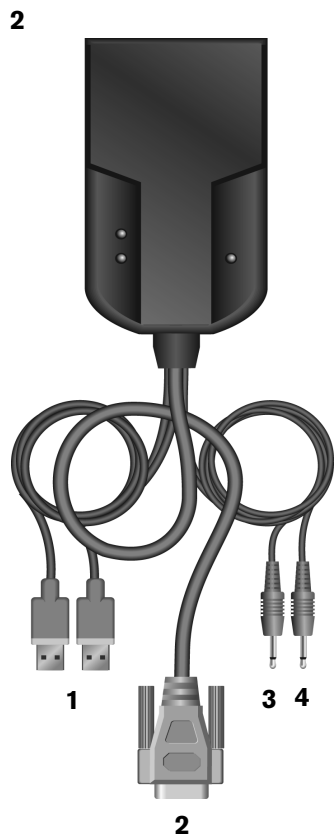

Figure 2.2: HMIQDI Transmitter

Table 2.2: Figure 2.2 Descriptions

Number	Type of Connector
1	USB
2	Video
3	Mic
4	Line-out

To connect the HMX 1050 user station:

1. Connect your keyboard, monitor, mouse and other peripherals cables to the appropriately labeled ports on the back of the HMX 1050 user station.
2. Connect the UTP cable to the RJ-45 port on the back of the HMX 1050 user station.

- Turn on the HMX 1050 user station. A connection will be automatically established with the remote workstation.

NOTE: VGA monitors can be connected to the HMX 1050 user station by using a DVI-I to VGA adaptor.

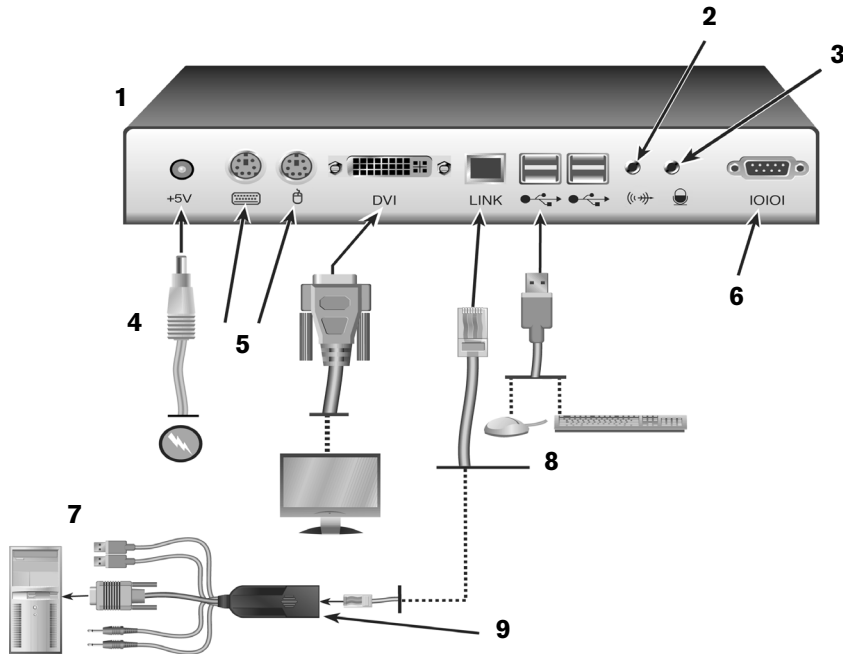

Figure 2.3: HMX 1050 User Station and HMIQDI Transmitter Installation

Table 2.3: Figure 2.3 Descriptions

Number	Description
1	HMX 1050 User Station
2	Microphone Port
3	Speaker Port
4	External Power Supply
5	PS/2 Ports
6	Serial Port
7	Remote Workstation

Table 2.3: Figure 2.3 Descriptions (Continued)

Number	Description
8	Local Peripherals (attached via USB)
9	HMIQDI Transmitter

Connecting power

The HMX 1050 user station features an external power supply. A DC power jack is located on the rear of the HMX 1050 user station.

NOTE: Use only the power supply provided by Avocent.

To connect power to the HMX 1050 user station:

1. Plug the external power supply's 2.5 mm connector into the DC power jack on the rear of the HMX 1050 user station.
2. Connect the detachable IEC power cord to the power supply.
3. Plug the IEC power cord into an appropriate wall outlet.

Networked installation

The following instructions will enable you to install your HMX 1050 user station and HMIQDI transmitter in a networked configuration. In this installation, multiple HMIQDI transmitters and HMX 1050 user stations are attached via the same Ethernet network. In this case, it is important for each unit to be configured with a unique IP address.

NOTE: In Desktop and Extender Modes, the HMX 1050 user station and HMIQDI transmitter can obtain their IP address data from a DHCP server.

HMIQDI transmitters and HMX 1050 user stations may be configured for use on a single subnet or for use across routers. Use of routers, however, will cause a slight increase in end-to-end latencies, which may not be acceptable for all applications.

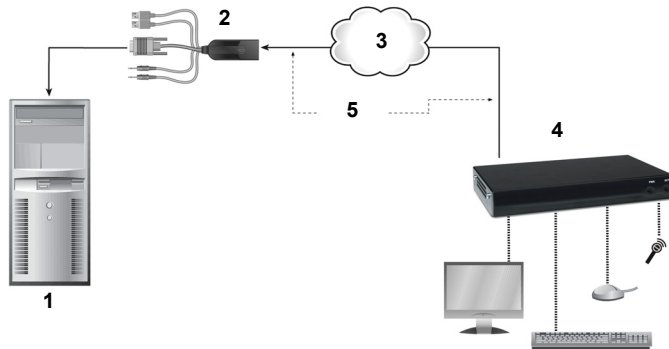

Figure 2.4: Networked Installation

Table 2.4: Figure 2.4 Descriptions

Number	Description
1	Remote Workstation
2	HMIQDI Transmitter
3	IP Network
4	HMX 1050 User Station
5	UTP Cable

The HMX 1050 user station has been preconfigured with factory-default network settings. If you install only one HMX 1050 user station and one HMIQDI transmitter on a subnet, you do not need to change these default network settings. If you install multiple units on the same subnet, you will need to assign a unique IP address to each unit or configure them for DHCP. This can be done via the serial port and must be carried out before displaying multiple devices on the same network. See Chapter 3 for more information.

NOTE: The DHCP server must be configured to assign IP addresses to the user station that do not expire. Do not change the mode to DHCP unless the equipment is connected to a DHCP server.

Table 2.5: HMX System Default Network Settings (HMX 1050 User Station)

Component	IP Address	Type	Default Gateway	Subnet Mask
HMX 1050 User Station	192.168.13.1	Static	0.0.0.0	255.255.255.0
HMIQDI Transmitter	192.168.13.2	Static	0.0.0.0	255.255.255.0

To install the HMX system on a network with the HMX 1050 user station:

1. With the HMIQDI transmitter already connected to the remote workstation, connect it to the LAN via the unit's RJ-45 connector.
2. Connect the HMX 1050 user station to the peripherals. Use UTP cable to connect the HMX 1050 user station to the Ethernet network via the RJ-45 connector on the rear of the HMX 1050 user station.
3. Turn on the HMX 1050 user station. A connection will be automatically established with the remote workstation.
4. Use the serial menu to reconfigure the network settings for the HMIQDI transmitter.

NOTE: If the HMX 1050 user station and HMIQDI transmitter are to be located on different subnets, configure their network settings before you connect to the network.

NOTE: If there are already HMIQDI transmitter and HMX 1050 user station pairs operating on the subnet, configure network settings of new HMIQDI transmitter and HMX 1050 user station pairs before connecting them to the network.

5. Use the serial menu to reconfigure the network settings for the HMX 1050 user station.
6. Repeat this procedure for each HMIQDI transmitter and HMX 1050 user station pair you wish to install on the network.

To install the HMX system on a network in Desktop Mode:

1. Ensure that each HMIQDI transmitter and HMX 1050 user station has a unique IP address.
2. Using the HMX Manager, locate and add the units to the HMX Manager database. For information on how to do this, refer to the HMX Manager Installer/User Guide.

Installing the HMX 1070 and HMX 2050 User Stations

Before installing your HMX 1070 or HMX 2050 user station, refer to the list below to ensure that you have all the items necessary for installation.

Needed to install the HMX 1070 or HMX 2050 user station

- Two external power supplies
- Two IEC power cords
- Applicable Quick Installation Guide
- KVM cable
- UTP cable (not supplied)
- Three-wire serial cable or null modem cable (not supplied)

Needed for non-standard installations (HMX 2050 user station only)

To connect a VGA monitor to the user station, a DVI to VGA adaptor is required (not supplied).

Mounting option

The user station mounts to the rear of a flat panel monitor via a mounting plate accessory.

NOTE: Mounting accessories for user station and transmitters are ordered separately. Contact Avocent for more information.

Installation options



CAUTION: To reduce the risk of electric shock or damage to your equipment, disconnect the power from the HMX 2050 or HMX 1070 user station by unplugging the power supply from the electrical outlet. To reduce the risk of electric shock or damage to your equipment, turn on the remote workstation and the HMX 2050 or HMX 1070 user station and HMIQDHDD or HMIQSHDI transmitter in the order described in the following procedures.

You can install the HMX system with the HMX 1070 or HMX 2050 user station either by a point-to-point or networked configuration.

Point-to-point installation HMX 1070 and HMX 2050 user station

In a point-to-point configuration, no administrator setup of the transmitter or the user station is required. This enables you to install the system quickly, directly out-of-the-box. However, if you choose the point-to-point configuration, you can install only one transmitter and user station pair on a subnet, and both must be on the same subnet.

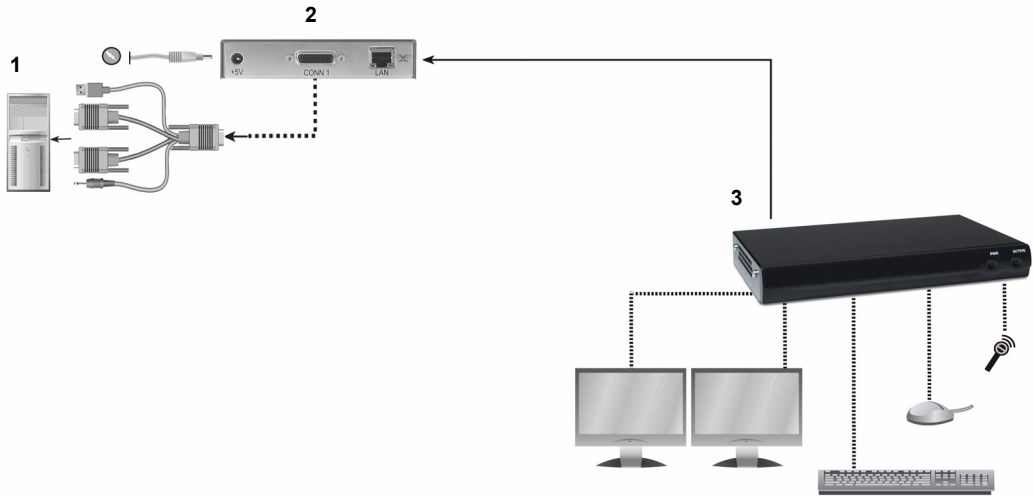

Figure 2.5: Point-to-Point Installation (HMX 2050 User Station)

Table 2.6: Figure 2.5 Descriptions

Number	Description
1	Remote Workstation
2	HMIQDHDD Transmitter
3	HMX 2050 User Station

To connect the HMIQSHDI or HMIQDHDD transmitter:

Before connecting the HMIQSHDI or HMIQDHDD transmitter to the remote workstation, ensure that the resolution and the refresh rate of the remote workstation are supported by the user station. Set the screen resolution and refresh rate of the remote workstation. Unsupported settings will cause blank video at the user station.

NOTE: Please see Appendix A for information on supported resolutions and refresh rates.

1. Turn off the remote workstation.
2. Connect the USB connector on the transmitter to the corresponding USB port on the workstation.

3. Connect the video connector and audio connector on the HMIQSHDI or HMIQDHDD transmitter to the appropriately labeled ports on the back of the workstation.

NOTE: For CD-quality audio, you must configure the transmitter and the user station using the serial menu.

4. Connect one end of the UTP cable to the transmitter's RJ-45 connector and turn on the workstation.
5. Route the other end of the UTP cable to the location you have chosen for the user station. If necessary, you can extend the UTP cable via junctions or a hub (subject to normal Ethernet cabling practices).

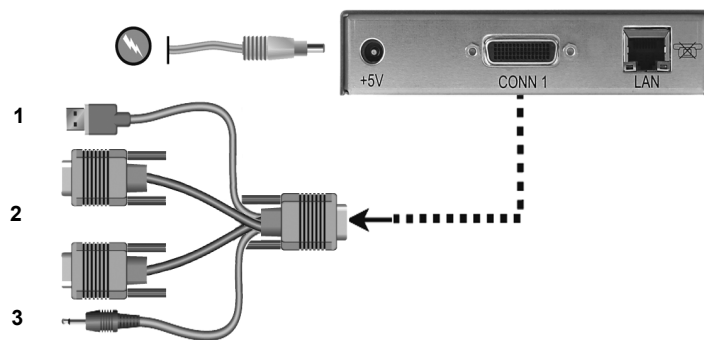

Figure 2.6: HMIQDHDD Transmitter Shown

Table 2.7: Figure 2.6 Descriptions

Number	Description
1	USB
2	Video
3	Line-out

NOTE: The HMIQSHDI transmitter features one DVI-D connector and one VGA connector.

To connect the HMX 1070 or HMX 2050 user station:

1. Connect your keyboard, monitor, mouse and other peripherals cables to the appropriately labeled ports on the back of the user station.
2. Connect the UTP cable to the RJ-45 port on the back of the user station.

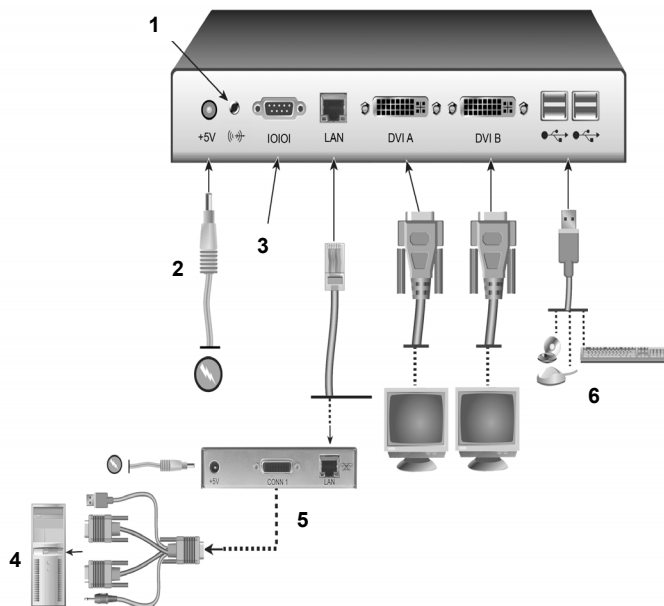

Figure 2.7: HMX 2050 User Station and HMIQDHDD Transmitter Installation Shown

Table 2.8: Figure 2.7 Descriptions

Number	Description
1	Speakers
2	External Power Supply
3	Serial Port
4	Remote Workstation
5	HMIQDHDD Transmitter
6	Local Peripherals attached via USB

Connecting power

The HMX 1070 and HMX 2050 user stations and associated transmitters feature an external power supply. A DC power jack is located on the rear of each.

NOTE: Use only the power supply provided by Avocent.

To connect power to the user station and transmitter:

1. Plug the external power supply's 2.5mm connector into the DC power jack on the rear of the user station and transmitters.
2. Connect the detachable IEC power cord to the power supply.
3. Plug the IEC power cord into an appropriate wall outlet.

Networked installation

The following instructions will enable you to install your user station and transmitter in a networked configuration. In this installation, multiple transmitters and user stations are attached via the same Ethernet network. In this case, it is important for each unit to be configured with a unique IP address.

NOTE: In Desktop and Extender modes, the HMX 1070 and HMX 2050 user station and HMIQSHDI and HMIQDHDD transmitter can obtain their IP address data from a DHCP server.

Transmitters and user stations may be configured for use on a single subnet or for use across routers. Use of routers, however, will cause a slight increase in end-to-end latencies, which may not be acceptable for all applications.

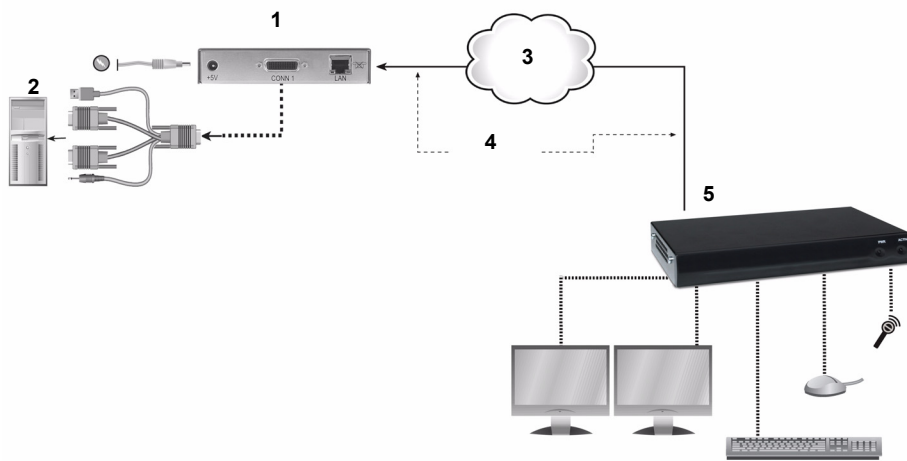

Figure 2.8: Networked Installation

Table 2.9: Figure 2.8 Descriptions

Number	Description
1	HMIQDHDD Transmitter
2	Remote Workstation
3	IP Network
4	UTP Cable
5	HMX 2050 User Station

The HMX 1070 and HMX 2050 user stations have been preconfigured with factory-default network settings. If you install only one user station and one associated transmitter on a subnet, you do not need to change these default network settings. If you install multiple units on the same subnet, you will need to assign a unique IP address to each unit or configure them for DHCP. This can be done via the serial port and must be carried out before displaying multiple devices on the same network.

NOTE: The DHCP server must be configured to assign IP addresses to the user station that do not expire. Do not change the mode to DHCP unless the equipment is connected to a DHCP server.

Table 2.10: HMX System Default Network Settings (HMX 2050 User Station)

Component	IP Address	Type	Default Gateway	Subnet Mask
HMX 2050 User Station	192.168.13.1	Static	0.0.0.0	255.255.255.0
HMIQDHDD Transmitter	192.168.13.2	Static	0.0.0.0	255.255.255.0

To install the HMX 1070 or HMX 2050 user station and associated transmitter on a network:

1. Connect the transmitter to the remote workstation. Connect one end of the UTP cable to the transmitter's RJ-45 connector. Connect the other end of the UTP cable to the Ethernet network.
2. Connect the user station to the peripherals. Use a length of UTP cable to connect the user station to the Ethernet network via the RJ-45 connector on the rear of the user station.
3. Turn on the user station. A connection will be automatically established with the remote workstation.
4. Use the serial menu to reconfigure the network settings for the transmitter.

NOTE: If the user station and associated transmitter are to be located on different subnets, configure their network settings before you connect to the network.

NOTE: If there are already transmitters and user stations operating on the subnet, configure network settings of the new transmitter and user station pair before connecting them to the network.

5. Use the serial menu to reconfigure the network settings for the user station.
6. Repeat this procedure for each transmitter and user station pair you wish to install on the network.

To install the HMX system on a network in Desktop Mode:

1. Ensure that each transmitter and user station has a unique IP address.
2. Using the HMX Manager, locate and add the units to the HMX Manager database. For information on how to do this, refer to the HMX Manager Installer/User Guide.

Operations

Overview

Operating a workstation through the HMX system is no different than working directly connected to your workstation. All peripherals operate as if directly connected, even though the workstation is located at a distance.

While the HMX system default settings will work in most environments, you may configure the settings to better fit your installation via the serial menu. You can also upgrade the HMX system via the serial menu. See *Flash Upgrading your HMX System* on page 45 for more information.

LED identification

Front panel

There are two blue LEDs on the front panel of an HMX user station. The *PWR* LED will light up when the user station is turned on. The *ACTIVE* LED will blink slowly until the user station establishes a connection with the transmitter. When a connection is established between the user station and transmitter, the *ACTIVE* LED will stop blinking and will remain lit.

Rear panel

Two LEDs are built into the RJ-45 connectors on the user station and transmitter.

Table 3.1: RJ-45 Connector LEDs

LED	Indication	Meaning
LED 1	Green static	Linked at 1 Gbps
	Green flashing	Linked at 100 Mbps
	Green off	No Link
LED 2	Yellow static	Linked but no activity
	Yellow flashing	Transmit/receive activity

Accessing the System

Depending on your configuration, turning on an HMX user station will automatically initiate a connection with the remote workstation or display a user login. Once you are connected, a series of messages will be displayed on the screen to inform you of the progress of the connection. You will be able to interact with the remote workstation as if it were located at your desk.

NOTE: If the remote workstation has been turned off, the HMX user station cannot establish a connection.

OSD functions

The HMX user station incorporates an OSD that allows you to view information about the configuration of your system in Desktop Mode or Extender Mode. If you are in Extender Mode, or in Desktop Mode as an administrator or a user with configuration rights, the OSD also allows for setting network parameters such as the IP address.

Displaying system information using the OSD

The OSD enables you to display the firmware release of the user station and the transmitter. For optimum performance, keep your firmware current. The OSD also enables you to view the IP address and MAC address of both the HMX user station and transmitter.

To display system information:

1. Press **Print Screen** and select the *User* tab to display user information for your HMX user station.



Figure 3.1: User Dialog Box (Matrix Mode)

2. If the user has access to a list of target computers, the Target dialog box will appear when the *Target* tab is selected. The Target dialog box displays a list of target computers to which the user has access.

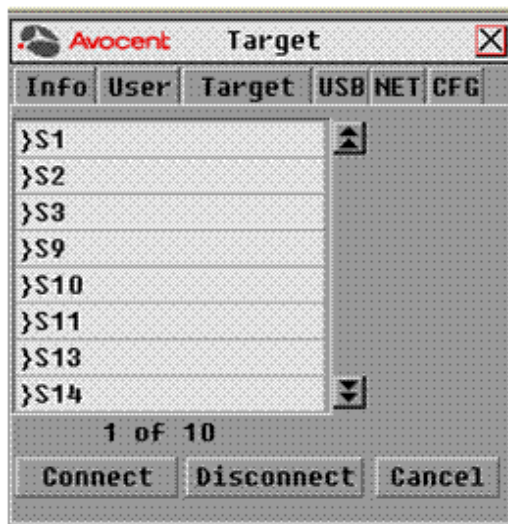

Figure 3.2: Target Dialog Box

3. Click the *Info* tab to view system information for your user station and transmitter.
4. Click the *Rcvr* radio button to view the system information for your user station.

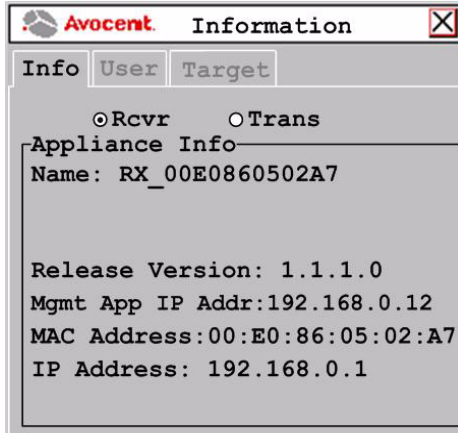

Figure 3.3: User Station Connected to Transmitter

-or-

Click the *Trans* radio button to view the system information for your transmitter.

NOTE: If there is no transmitter connected, the Trans radio button option will display as *No Target*.

To initiate a connection with a remote computer in Extender Mode:

1. Press **Print Screen**.
2. Enter the Login Name and Password, ensuring that the appropriate keyboard has been selected.
3. Click the *OK* button. If the user has access to only one target computer, the login progress message will then appear and a connection will be established.

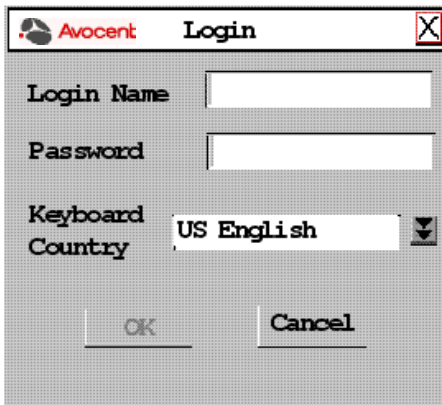

Figure 3.4: Login Screen

4. If the user has access to more than one target computer, then the list of target computers is presented.
5. Click the *Connect* button to establish a connection.

Configuring networking parameters using the OSD

If you are in Extender Mode, or in Desktop Mode as an administrator or a user with configuration rights, the OSD enables you to set the IP address, Netmask and Default gateway for the user station and the transmitter that is connected.

To change networking information for the user station and transmitter:

1. Press **Print Screen** and select the *Net* tab to configure network parameters for your HMX user station or transmitter.

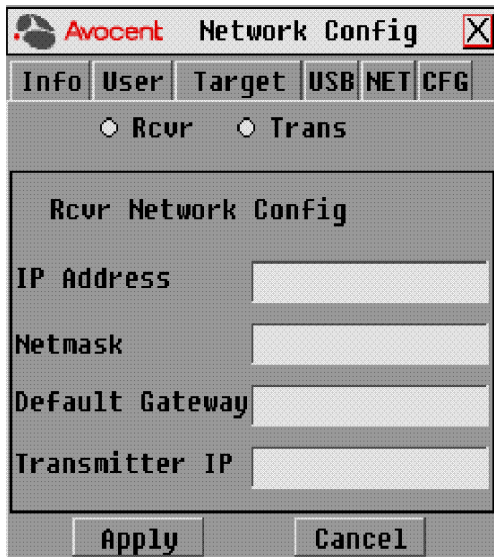

Figure 3.5: Network Config Menu (Receiver)

2. To change the user station network configuration, select *Rcvr* from the Network Config menu and fill out the desired information.
- or -
To change the transmitter network configuration, select *Trans* from the Network Config menu and fill out the desired information.
3. Click **Apply** to save the changes.

Setting the OSD timeout

The amount of time the OSD is displayed on the monitor is configurable.

To change the OSD Timeout:

1. Press **Print Screen** and select the *CFG* tab.



Figure 3.6: Configuration Menu (OSD Timeout and Auto Logout)

2. Enter the desired amount of time for the OSD to be displayed.
3. Click **Apply** to save the changes.

Setting the Auto Logout time-out

If there is no keyboard or mouse activity for an amount of time greater than the value set in the Auto Logout time-out, the user station will automatically disconnect from the transmitter and log off from the HMX Manager.

To change the Auto Logout time-out:

1. Press **Print Screen** and select the *CFG* tab (see Figure 3.6).
2. Enter the desired amount of time for the Auto Logout time-out.
3. Click **Apply** to save the changes.

Initiating a remote connection (Matrix Mode)**To initiate a connection with a remote computer in Matrix Mode:**

1. Press **Print Screen**.
2. Enter the Login Name and Password, ensuring that the appropriate keyboard has been selected.
3. Click the *OK* button to accept the changes.
4. In Matrix Mode, the Target window displays.
5. Select the remote computer to which you wish to connect and click *Connect*.

NOTE: Once a remote computer has been selected, Matrix Mode denies access to any other user.

Access through Auto-Login Mode

Using the HMX Manager, an administrator can enable Auto-Login Mode. Once this step is complete, the HMX user station is reset by the HMX Manager and it attempts to connect to the specified transmitter. A login progress message will be seen at this point.

NOTE: The OSD will clear after a defined period of inactivity. To reactivate the OSD, enter a valid hotkey sequence.

To display system information in Extender Mode:

1. Press **Print Screen**. In Extender Mode, the Info tab displays user information for your HMX user station by default.

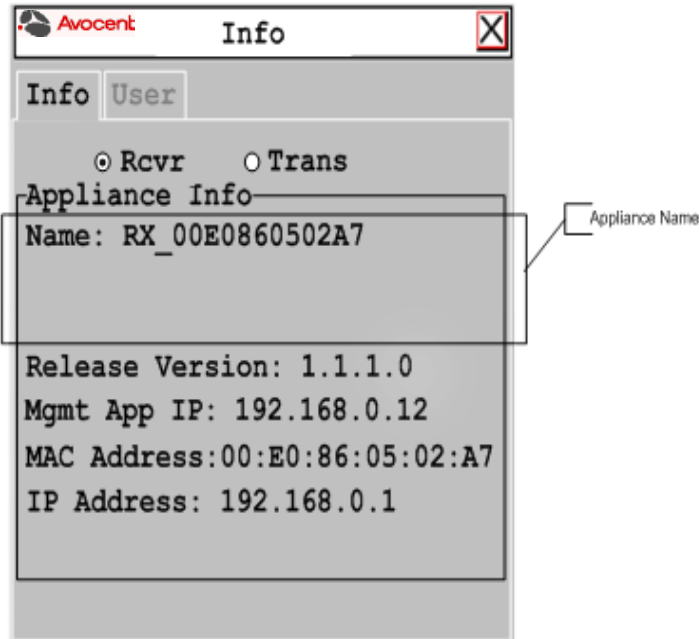

Figure 3.7: HMX User Station Connected to Transmitter

2. Click the *Rcvr* radio button to view system information for your HMX user station.
-or-
Click the *Trans* radio button to view the system information for your transmitter.

NOTE: If there is no transmitter connected, the Trans radio button option will display as *No Target*.

To close the OSD:

Press **ESC** or use the mouse to click the *X* button on the top right-hand corner of the OSD.

The Serial Menu

The HMX user station incorporates a serial menu that allows you to:

- Configure network settings for the HMX user station
- Configure network settings for the transmitter
- Set or change passwords
- Upgrade firmware for the HMX user station and transmitter
- Reset to factory defaults
- Set a session time-out value
- Change the audio performance settings
- Configure the transmitter for normal aspect or wide screen resolutions

Accessing the serial menu

You can access the serial menu via the serial port on the back of the HMX user station. All terminal commands are executed through a terminal or computer running HyperTerminal® emulation software or equivalent. By default, two passwords are required to access the HMX user station via the transmitter. One password controls access to the user station, the other password controls access to the transmitter. In both cases, the default password is **password**.

Items needed to access the serial menu

- Networked workstation with a serial port
- Null-modem serial cable (male DB9) or three-wire serial cable
- HyperTerminal emulation software or equivalent

NOTE: When utilizing the serial menu screens, the HMX user station is sometimes referred to as the receiver.

To access the serial menu:

1. Connect one end of the serial cable to the serial port on the back of the HMX user station.
2. Connect the other end of the serial cable to the serial port of your computer.
3. Launch HyperTerminal.
4. Within the COM1 Properties Port Settings tab, configure the HyperTerminal session for 57600 bits per second, 8 data bits, no parity, 1 stop bit and no flow control.

NOTE: Software (XON/XOFF) flow control is supported. However, it should not be used when using XMODEM.

5. Confirm the HyperTerminal settings and click *OK*.
6. Press **Enter** to display the serial menu. The Appliance Selection Menu will be displayed.

7. Select the Receiver or Transmitter Menu by pressing **1** or **2** and pressing **Enter**. You will be prompted to enter a password.
8. Type the password and press **Enter**.

NOTE: If there is no transmitter connected to the HMX user station, an error message will display and you will be returned to the Appliance Selection Menu.

Navigating the serial menu

To navigate through the serial menu, type the number or letter that corresponds to the option you wish to choose and press **Enter**. This action will bring you to a sub-menu or screen where you can make configuration changes. To exit a menu or screen and to confirm any configuration changes you have made, type **0** (zero) and press **Enter**.

Configuring Network Settings

Each HMX system component is shipped with default network settings preconfigured. You can change the default values using the serial menu.

NOTE: IP address data can be obtained by DHCP or can be set to Static (default).

NOTE: It is recommended that you configure the network settings for the transmitter before you configure the network settings for the HMX user station.

To configure network settings for the transmitter:

1. Press **Enter** to display the serial menu. The Appliance Selection Menu displays.
2. Press **2** to access the Transmitter Menu. If the password option is enabled, you will be prompted for a password.
3. Type the password and press **Enter**. The Transmitter Main Menu will appear.

```

1. Video Debug Information
0. Exit
Enter selection -> 0

-----
Transmitter Serial Console
Copyright (c) 2000-2008. All rights reserved
-----
Main Menu
-----
1. Network Configuration
2. Security Configuration
3. Firmware Management
4. Restore Factory Defaults
5. Reset Appliance
6. Appliance Information
7. Console Settings
8. Debug Information
0. Exit
Enter selection ->

```

Figure 3.8: Transmitter Main Menu

NOTE: The Reset Appliance option in the Transmitter Main Menu applies only to network settings.

- Press **1** to select the Network Configuration option and press **Enter**.

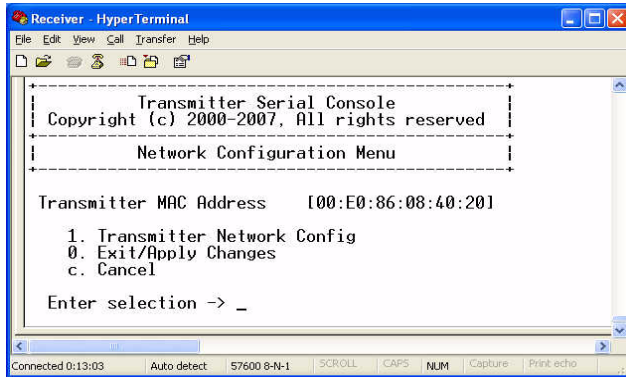

Figure 3.9: Network Configuration Menu

- Press **1** to select the Transmitter Network Config option and press **Enter**.

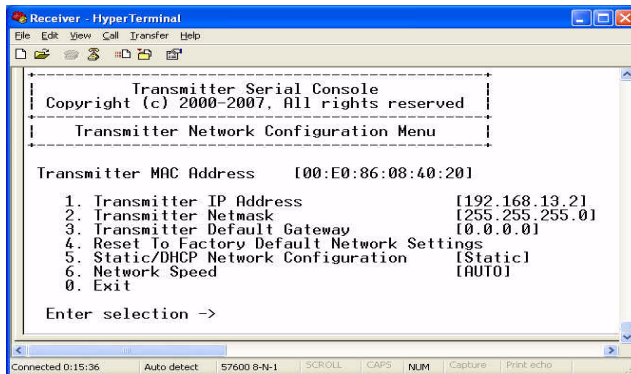

Figure 3.10: Transmitter Network Configuration Menu

- Press **1** to select the Transmitter IP Address option and press **Enter**.
- Type a valid IP address and press **Enter**.
- Press **2** to select the Transmitter Netmask option and press **Enter**.
- Type a valid Transmitter Netmask. Press **Enter** to return to the Transmitter Network Configuration Menu.
- Press **3** to select the Transmitter Default Gateway option and press **Enter**.
- Type a valid Transmitter Default Gateway and press **Enter**.
- Type **0** (zero) and press **Enter** to exit and apply changes, or to return to the Network Configuration Menu. If you made a mistake and do not wish to save the changes you made to the network settings, type **C** and press **Enter**.

13. A system message will appear that states *Connection to the Transmitter is lost*. You will be automatically returned to the Appliance Selection Menu screen.

To configure network settings for the user station:

1. Press option **1** to access the Receiver Menu and press **Enter**. If the password option is enabled, you will be prompted for a password.
2. Type the password and press **Enter**. The Receiver Main Menu will appear.

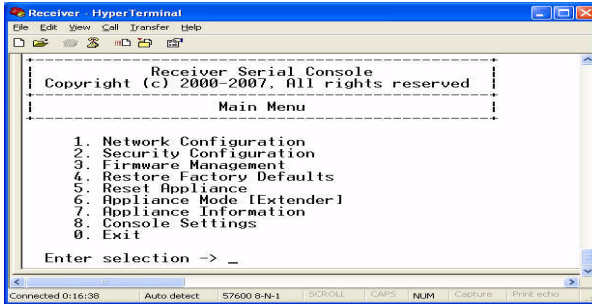

Figure 3.11: Receiver Main Menu

NOTE: The Network Configuration Menu is different for the Extender and Desktop modes.

To access the Network Configuration Menu in Extender Mode:

1. Press **1** to select the Network Configuration option and press **Enter**. The Network Configuration Menu (Extender Mode) appears.

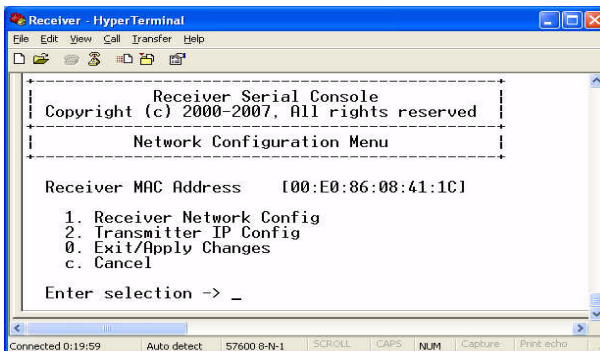

Figure 3.12: Network Configuration Menu (Extender Mode)

- Press **2** to select the Transmitter IP Config option and press **Enter**. The old Transmitter IP Address is displayed beside menu option 1.

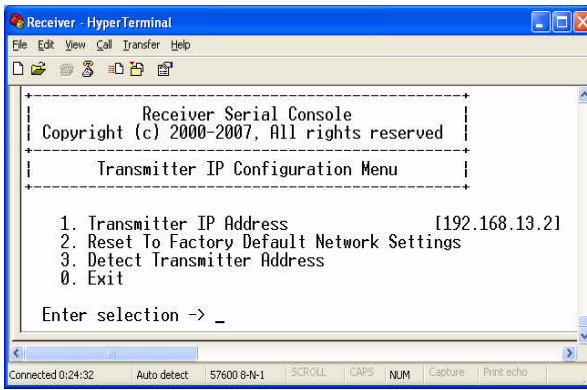

Figure 3.13: Transmitter Configuration Menu on the HMX User Station

- Press **1** to select the Transmitter IP Address option and press **Enter**. Type the new IP address for the transmitter and then press **Enter**.
- Type **0** (zero) and press **Enter** to return to the Network Configuration Menu. If you made a mistake and do not wish to save the changes you made to the network settings type **C** and press **Enter**.

The HMX user station will now automatically reset to apply the new network configuration. You will be automatically returned to the Appliance Selection Menu screen. The connection to the transmitter will be automatically restored.

To access the Network Configuration Menu in Desktop Mode:

- Press **6** to select Appliance Mode in the Receiver Main Menu and press **Enter**. The Appliance Mode Menu will appear.
- Press **2** to select the Desktop Mode and press **Enter**.
- To confirm your changes and apply those settings, type **0** (zero) and press **Enter**. You are now in Desktop Mode.

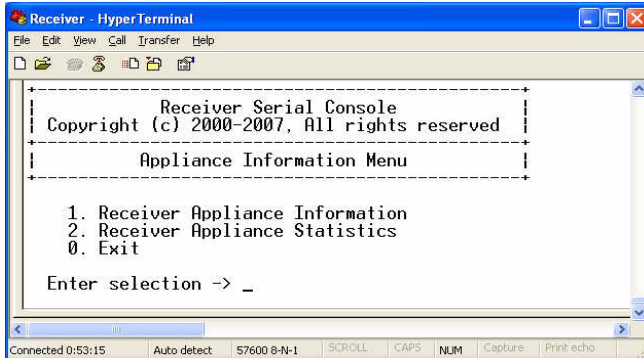

Figure 3.14: Appliance Mode Menu

4. Press **Enter** to activate the serial menu. The Appliance Selection Menu displays.
5. Press **1** to access the Receiver Menu. If the password option is enabled, you will be prompted for a password.
6. Type the password and press **Enter**. The Receiver Main Menu (Desktop Mode) will appear.
7. Press **1** to select the Network Configuration option and press **Enter**.

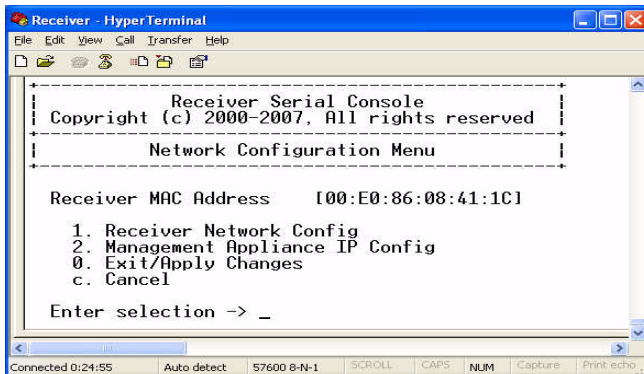

Figure 3.15: Network Configuration Menu (Desktop Mode)

To configure the network settings for the user station:

1. Press **1** to select the Receiver Network Config option in the Network Configuration Menu (in either Extender or Desktop Mode) and press **Enter**.

NOTE: The Receiver Network Configuration Menu is identical in both Extender and Desktop modes.

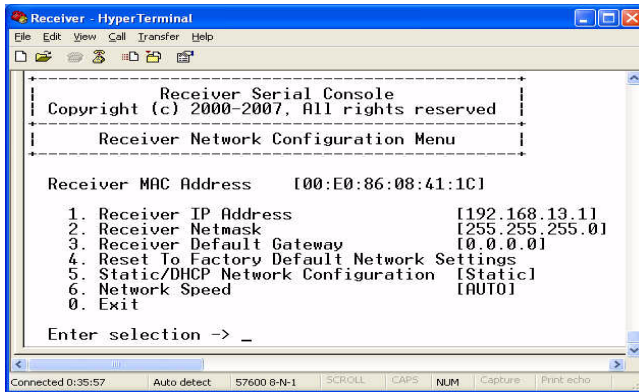

Figure 3.16: Receiver Network Configuration Menu (Extender and Desktop Mode)

NOTE: The reset option in the Receiver Network Configuration Menu applies only to network settings.

2. Press **1** to select the Receiver IP Address option and press **Enter**.
3. Type a valid IP address and press **Enter**.
4. Press **2** to select the Receiver Netmask option and press **Enter**.
5. Type a valid Receiver Netmask and press **Enter**.
6. Press **3** to select the Receiver Default Gateway option and press **Enter**.
7. Type a valid Receiver Default Gateway and press **Enter**.
8. Press **5** to select the Static/DHCP Network Configuration option to toggle between Static and DHCP mode. Press **Enter**.
9. Press **6** to select the Network Speed option to toggle between Auto-Negotiate mode (option 1) or 100Base TX full duplex mode (option 2).

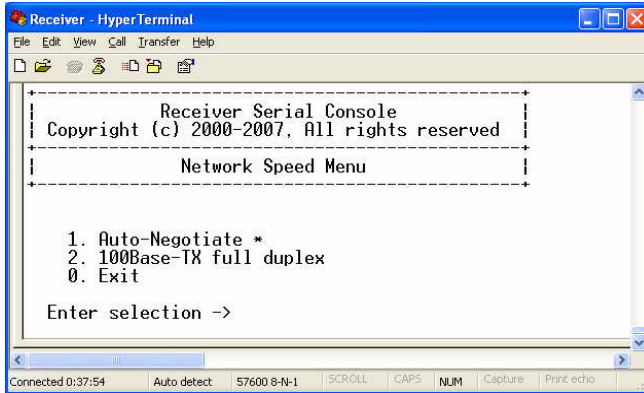

Figure 3.17: Network Speed Menu

10. Type **0** (zero) and press **Enter** to exit and apply changes, or to return to the Network Configuration Menu. If you made a mistake and do not wish to save the changes you made to the network settings, type **C** and press **Enter**.

NOTE: Changes to network configurations are applied only after you exit the Network Configuration Menu.

The HMX user station will now automatically reset to apply the new network configuration. During reset, the HMX user station will drop its connection to the transmitter. You will be returned to the Appliance Selection Menu screen. The connection will be restored.

NOTE: The currently selected network speed, Auto-Negotiate, is marked with an asterisk.

To access the HMX Manager IP Configuration Menu:

1. Press **6** to select the Appliance Mode option in the Receiver Main Menu and press **Enter**.
2. Select number **2** for Desktop Mode and press **Enter**. You are now in Desktop Mode.
3. Press **1** to access the Receiver Main Menu and press **Enter**. If the password option is enabled, you will be prompted for a password.
4. Type the password and press **Enter**.
5. Select number **1** for Network Configuration and press **Enter**. The Network Configuration Menu (Desktop Mode) will appear.
6. Press **2** to select the Management Appliance IP Configuration Menu in the Network Configuration Menu (Desktop Mode) and press **Enter**.

7. Press **1** to select Management Appliance IP Address.

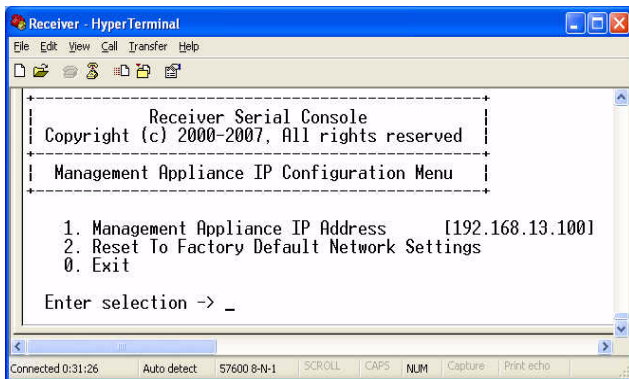

Figure 3.18: HMX Manager IP Configuration Menu

8. Type a valid IP address and press **Enter**.
9. Type **0** (zero) and press **Enter** to return to the Network Configuration Menu.
10. Type **0** (zero) and press **Enter** to return to the Main Menu.

- or -

If you do not want to save changes made in the Management Appliance IP Configuration Menu, Type **C** (or **cancel**) and return to the Main Menu.

Detecting a transmitter IP address

In the event that you forget the IP address of a transmitter, you can use the serial menu to detect the IP address of a transmitter that is connected to the HMX user station.

NOTE: This can only be done if the transmitter has been assigned a static IP address.

To detect the IP address of a connected transmitter:

1. Turn off the transmitter and directly connect it to the user station.

NOTE: If the transmitter receives its power from an external power supply, disconnect the transmitter from that external power supply.

- Press **1** to access the Receiver Main Menu and press **Enter**. If the password option is enabled, you will be prompted for a password.

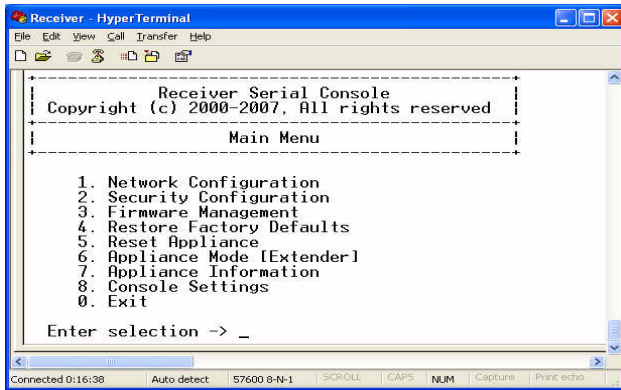

Figure 3.19: Receiver Main Menu

- Press **1** to select Network Configuration and press **Enter**. The Network Configuration Menu will appear.

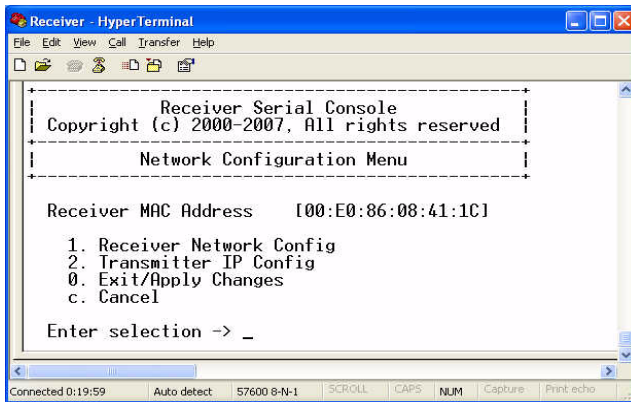

Figure 3.20: Network Configuration Menu

- Press **2** to select Transmitter IP Config and press **Enter**. The Transmitter IP Config menu will appear. The old Transmitter IP Address is displayed beside menu option 1.

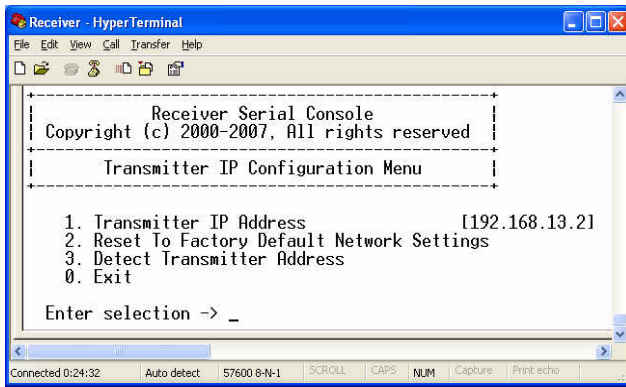

Figure 3.21: Transmitter IP Configuration Menu on the HMX User Station

NOTE: This screen is available only in Extender Mode.

- Press **3** to select Detect Transmitter Address and press **Enter**.
- Turn on the transmitter.
- The HMX user station will detect and save the IP address of the connected transmitter. The Transmitter IP Configuration Menu will refresh, and the current IP address of the connected Transmitter will be displayed beside menu option 1.
- To save your changes and exit the menu, type **0** (zero) and press **Enter**.

Authentication

Authentication for the HMX user station

You can change the password settings for the HMX user station through the serial menu via the Receiver Security Configuration Menu.

To access the Receiver Security Configuration Menu:

- Press **Enter** to display the serial menu. The Appliance Selection Menu will be displayed.
- Press **1** to access the Receiver Main Menu and press **Enter**. If the password option is enabled, you will be prompted for a password.

- Press **2** to select the Security Configuration option and press **Enter**.

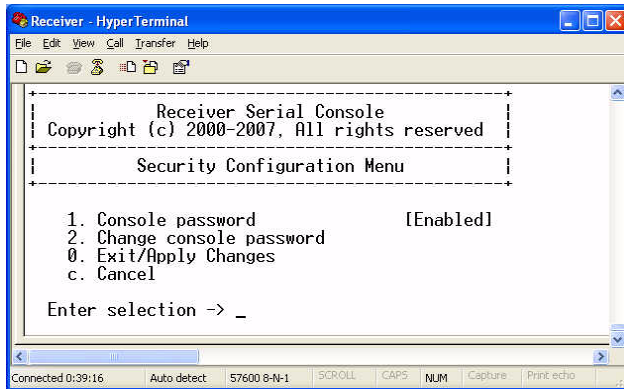

Figure 3.22: The Receiver Security Configuration Menu

NOTE: Press **1** to select Console password and press **Enter** to enable or disable a console password.

To change the user station password:

- Press **2** to select Change console password and press **Enter**. You will be prompted to enter your current password.
- Type your current password and press **Enter**. You will be prompted to enter the new password.
- Type the new password and press **Enter**.

NOTE: Each password must consist of ASCII characters and contain between 6 and 64 characters.

- Confirm the new password. If successful, you will see a message stating that the password has been changed.
- Press **Enter**.
- To save your changes and exit the menu, type **0** (zero) and press **Enter**.

To reset your user station password:

If you lose your user station password, you can reset the system to the default password with the help of Avocent Technical Support.

- From the serial menu, press **1** to access the Receiver Menu (if you lose your transmitter password, press **2** and continue with the following steps). Press **Enter**.
- You will be prompted to enter your current password.
- Type **??????** (six question marks) and press **Enter**. The serial menu will generate a code and display it to you. The code is a 16 character hex sequence. The serial menu will also prompt you to enter a Key.
- Contact Avocent Technical Support to obtain the Key.

5. In the serial menu at the Key prompt, type the new 16 character hex sequence provided by Avocent Technical Support. Press **Enter**.
6. The default password is now active.

Authentication for the transmitter

You can change the password settings for the transmitter through the serial menu using the Transmitter Security Configuration Menu.

To access the Transmitter Security Configuration Menu:

1. Press **Enter** to display the serial menu.
2. Press **2** to access the Transmitter Main Menu and press **Enter**. If the password option is enabled, you will be prompted for a password.

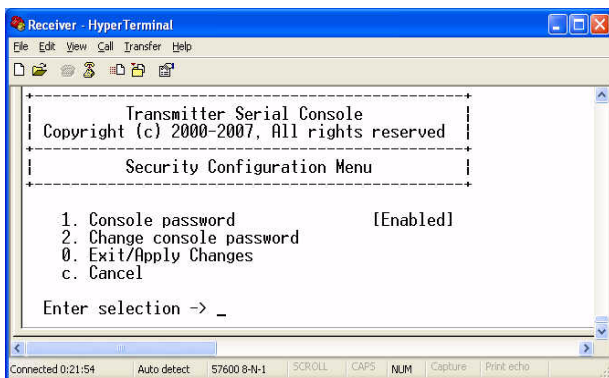

Figure 3.23: Transmitter Security Configuration Menu

To disable or enable the transmitter password:

NOTE: From the security Configuration menu, press **1** to enable or disable the password.

To change the transmitter password:

1. Press **2** to access the Change Console password menu on the Security Configuration Menu and press **Enter**. You will be prompted to enter your current password.
2. Type your current password and press **Enter**. You will be prompted to enter the new password.
3. Type the new password and press **Enter**.

NOTE: Each password must consist of ASCII characters and contain between 6 and 64 characters.

4. Confirm the new password. If successful, you will see a message stating that the password has been changed.
5. Press **Enter**.
6. To confirm the new password and exit the screen, type **0** (zero) and press **Enter**.

Flash Upgrading your HMX System

You can Flash upgrade your HMX user station and transmitter using either XMODEM or HTTP. The HMX user station and transmitter are upgraded separately using individual upgrade files available from Avocent. For optimum system performance keep your firmware versions current.

NOTE: Do not use software (XON/XOFF) flow control when using XMODEM.

NOTE: It is recommended that you Flash upgrade the transmitter before you Flash upgrade the HMX user station. Transmitters and user stations should have the same version for guaranteed operation.

To Flash upgrade your transmitter using XMODEM:

1. Download the transmitter upgrade file from Avocent.
2. From the serial menu, press **2** to access the Transmitter Main Menu and press **Enter**. If the password option is enabled, you will be prompted for a password.
3. Press **5** to access the Firmware Management Menu and press **Enter**.

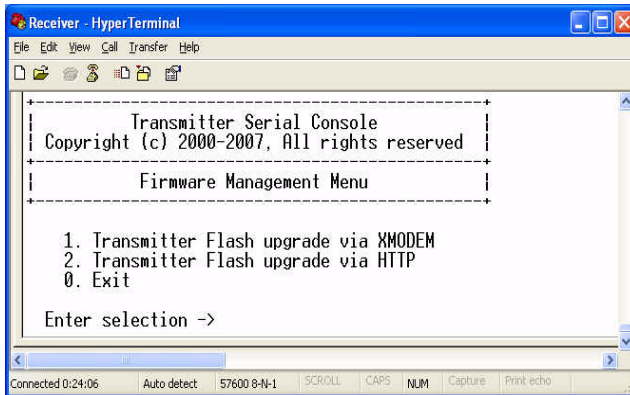

Figure 3.24: Transmitter Firmware Management Menu

4. Press **1** to select the Transmitter Flash upgrade via XMODEM menu. Press **Enter**.
5. Specify the location of the upgrade file and initiate the file transfer.
6. When the transfer has completed, a message will display stating *Firmware update successful. Resetting Appliance*. During reset the transmitter will drop the connection to the HMX user station. A second system message will appear that states: *Connection to the transmitter is lost*. You will be automatically returned to the Appliance Selection Menu screen.

NOTE: If the transmitter determines that the upgrade file is invalid, the transmitter cancels the upgrade and maintains the previous firmware version. A message displays indicating that the upgrade has failed.

To Flash upgrade your transmitter using HTTP:

1. Download the Transmitter upgrade file from Avocent.

2. Press **Enter** to display the serial menu.
3. Press **2** to access the Transmitter Main Menu and press **Enter**. If the password option is enabled, you will be prompted for a password.
4. Press **5** to access the Firmware Management Menu.
5. Press **2** to select Transmitter Flash upgrade via HTTP and press **Enter**. You will be prompted to enter the URL for the upgrade file.
6. Enter the URL for the upgrade file using the following syntax:
`http://<server ip address>[:server port]/<upgrade file path>`
 For example:
http://192.168.13.3:8080/TX.dld

NOTE: If the server is set up on standard port 80, the port information can be omitted.

7. To initiate the file transfer, press **Enter**. The connection to the transmitter will be dropped.
8. When the transfer has completed, a message will display stating *Firmware update successful. Resetting Appliance*. During reset the transmitter will drop the connection to the HMX user station. A second system message will appear that states: *Connection to the Transmitter is lost*. You will be automatically returned to the Appliance Selection Menu screen.

NOTE: If the transmitter determines that the upgrade file is invalid, the transmitter cancels the upgrade and maintains the previous firmware version. A message displays indicating that the upgrade has failed.

To Flash upgrade your HMX user station using XMODEM:

NOTE: You should Flash upgrade the transmitter before you Flash upgrade the HMX user station.

1. Download the HMX user station upgrade file from Avocent.
2. From the serial menu, press **1** to access the Receiver Main Menu and press **Enter**. If the password option is enabled, you will be prompted for a password.
3. Press **5** to access the Firmware Management Menu and press **Enter**.

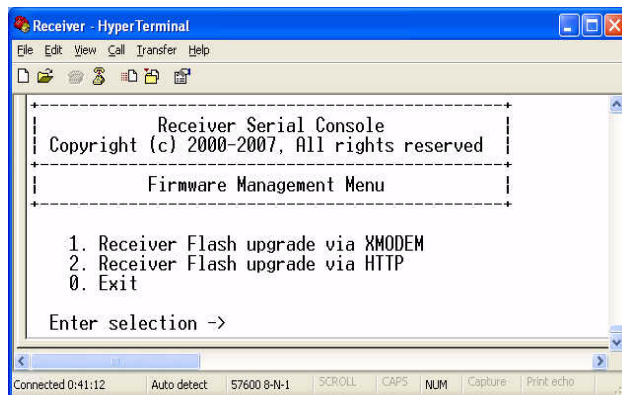

Figure 3.25: Receiver Firmware Management Menu

4. Press **1** to select Receiver Flash upgrade via XMODEM and press **Enter**. The connection to the transmitter will be dropped.
5. Specify the location of the upgrade file and initiate the file transfer.
6. When the transfer has completed, a message will display stating *Firmware update successful. Resetting Appliance*. The connection to the HMX user station will be restored.

NOTE: If the HMX user station determines that the upgrade file is invalid, the HMX user station cancels the upgrade and maintains the previous firmware version. A message will display indicating that the firmware upgrade has failed.

To Flash upgrade your HMX user station using HTTP:

1. Download the HMX user station upgrade file from Avocent.
2. From the serial menu, press **1** to access the Receiver Main Menu and press **Enter**. If the password option is enabled, you will be prompted for a password.
3. Press **5** to access the Firmware Management Menu and press **Enter**.
4. Press **2** to select Receiver Flash upgrade via HTTP and press **Enter**. You will be prompted to enter the URL for the upgrade file.
5. Enter the URL for the upgrade file using the following syntax:
http://<server ip address>[:server port]/<upgrade file path>
For example:
http://192.168.13.3:8080/RX.dld

NOTE: If the server is set up on standard port 80, the port information can be omitted.

6. To initiate the file transfer, press **Enter**. The connection to the transmitter will be dropped.
7. When the transfer has completed, a message will display stating *Firmware update successful. Resetting Appliance*. The connection to the transmitter will be restored.

NOTE: If the HMX user station determines that the upgrade file is invalid, the HMX user station cancels the upgrade and maintains the previous firmware version. A message will display indicating that the firmware upgrade has failed.

Restoring Factory Default Settings

The serial menu enables you to easily restore the factory default settings of both the HMX user station and the transmitter.

NOTE: Restoring factory default settings will also reset network settings. Before restoring factory default settings, assess whether this is likely to cause conflicts with other devices on the network.

To restore the HMX user station or transmitter factory default settings:

1. From the serial menu, press **1** to access the Receiver Main Menu or press **2** to access the Transmitter Main Menu and press **Enter**. If the password option is enabled, you will be prompted for a password.
2. Type the password and press **Enter**. The Receiver or Transmitter Main Menu will appear.
3. Press **4** to access the Restore Factory Defaults menu and press **Enter**.
4. Defaults will now automatically reset. You will be automatically returned to the Appliance Selection Menu.
5. During reset, the HMX user station will drop the connection to the transmitter. When reset is complete, the HMX user station will restore the connection to the transmitter using the new settings.

Resetting the HMX System

To reset the HMX user station:

1. From the serial menu, press **1** to access the Receiver Main Menu and press **Enter**. If the password option is enabled, you will be prompted for a password.
2. The Receiver Main Menu will appear.
3. Press **5** to access the Reset Appliance Menu and press **Enter**.

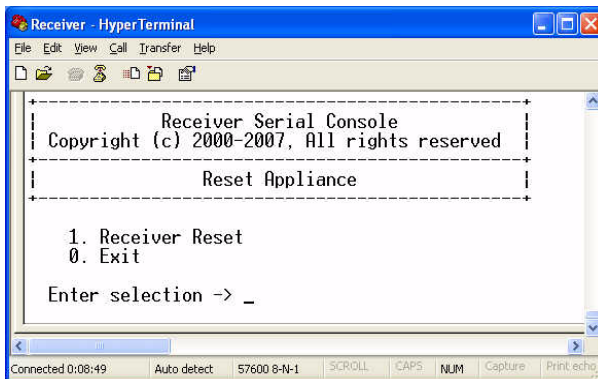

Figure 3.26: Receiver Reset Appliance Menu

4. Press **1** and **Enter** to access the Receiver Reset menu to initiate the reset. A message will be displayed on the serial menu that states *Resetting appliance*. During reset, the connection to the transmitter is dropped. When the reset is complete, you will be automatically returned to the Appliance Selection Menu. The connection to the transmitter will be automatically restored.

To reset the transmitter:

1. Press **Enter** to display the serial menu.
2. Press **2** to access the Transmitter Main Menu and press **Enter**. If the password option is enabled, you will be prompted for a password. The Transmitter Main Menu will appear.
3. Press **5** to access the Reset Appliance menu and press **Enter**. The Reset Appliance Menu will appear.
4. Press **1** and **Enter** to access Receiver Reset Menu to initiate the reset. A message will be displayed on the serial menu that states *Resetting appliance*. During reset, the transmitter will drop the connection to the user station. A second system message will appear that states: *Connection to the Transmitter is lost*. You will be automatically returned to the Appliance Selection Menu. The connection will be automatically restored.

Viewing System Information

The serial menu enables you to display the firmware release and details of the HMX user station and of the transmitter.

To view HMX user station system information:

1. From the serial menu, press **1** to access the Receiver Main Menu and press **Enter**. If the password option is enabled, you will be prompted for a password.
2. Press **7** to access the Appliance Information menu and press **Enter**.

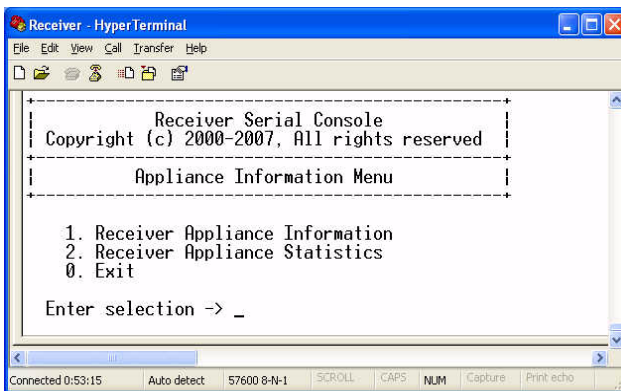

Figure 3.27: Appliance Information Menu

3. Press **1** to access the Receiver Appliance Information Menu and press **Enter**.

NOTE: The term “receiver appliance” is used interchangeably with “user station.”

The Receiver Appliance Information Menu screen contains the following information and all values are read-only:

- user station name
- EID number
- release version
- application
- boot and FPGA firmware version numbers
- manufacturing part number

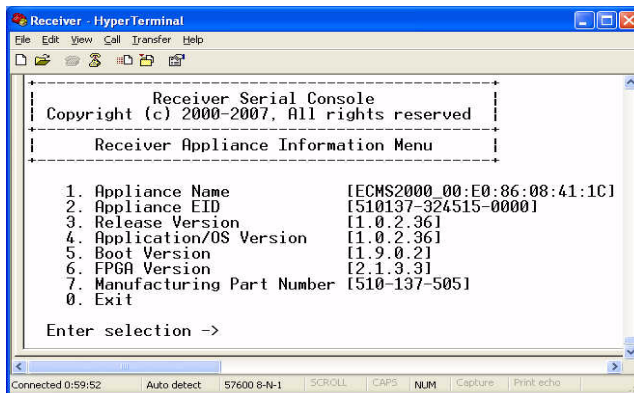

Figure 3.28: Receiver Appliance Information Menu

To view transmitter system information:

1. Press **Enter** to display the serial menu.
2. Press **2** to access the Transmitter Main Menu and press **Enter**. If the password option is enabled, you will be prompted for a password.
3. Press **6** to access the Appliance Information Menu and press **Enter**.
4. Press **1** to access the Transmitter Appliance Information Menu and press **Enter**. The Transmitter Appliance Information Menu will appear.

The Transmitter Appliance Information Menu screen contains the following read-only information:

- transmitter name
- EID number
- release version
- application
- boot and FPGA firmware version numbers
- manufacturing part number

Configuring Video Input Settings

The HMX 1050 and HMX 1070 user stations are capable of transmitting either digital (DVI) or analog video (VGA) from the remote workstation to your monitor. The HMX 2050 user station is capable of transmitting DVI only from the remote workstation to your analog or digital monitor. The HMX system will normally operate well when set on its default settings. The HMX 1050 user station needs the transmitter to be set for the dedicated video type to operate correctly.

NOTE: Video-display problems may occur if video input settings are not configured correctly,

To configure video input settings:

1. From the serial menu, press **2** to access the Transmitter Main Menu and press **Enter**. If the password option is enabled, you will be prompted for a password.
2. Press **7** to access the Console Settings Menu and press **Enter**. The Console Settings Menu will display.

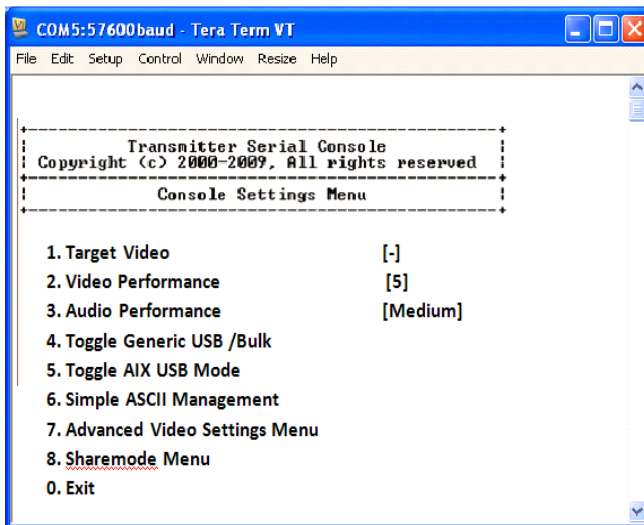

Figure 3.29: Transmitter Console Settings Menu

NOTE: Under Video Performance, the number 1 signifies lowest quality while 5 signifies highest quality.

- Press **1** to access the Target Video Menu and press **Enter**.

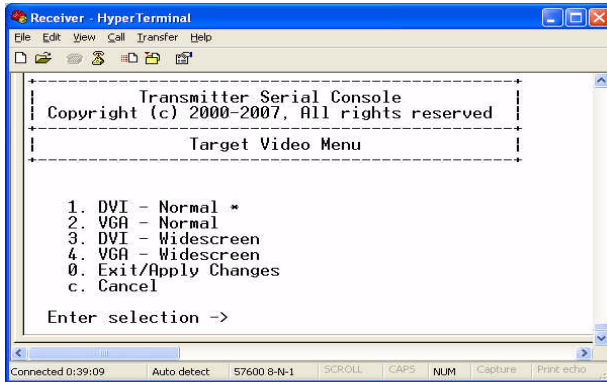

Figure 3.30: Transmitter Target Video Menu

- Press **1** to select DVI Normal and press **Enter**.
- Configure video input settings as appropriate.
- Type **0** (zero) and press **Enter** to save your changes and exit the menu. The unit resets.

Preferred monitor resolutions (EDID preferred timing)

The HMIQDI and HMIQD HDD transmitters can be configured to prefer certain monitor resolutions.

To configure preferred monitor resolutions:

- Press **2** on the serial menu to access the Transmitter Main Menu and press **Enter**. If the password option is enabled, you will be prompted for a password.
- Press **7** to access the Console Settings Menu and press **Enter**. The Console Settings Menu will display.
- Press **7** to access the Advanced Video Settings Menu.

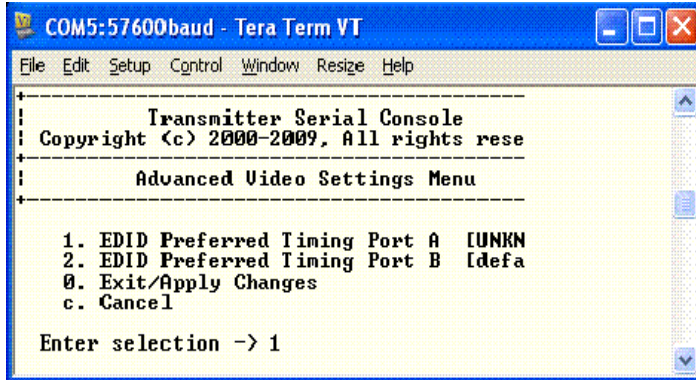

Figure 3.31: Advanced Video Settings Menu

4. Enter the number that represents the port to which you wish to set the EDID preferred timing, then enter **0** (zero) to Exit/Apply Changes or enter **c** to Cancel.

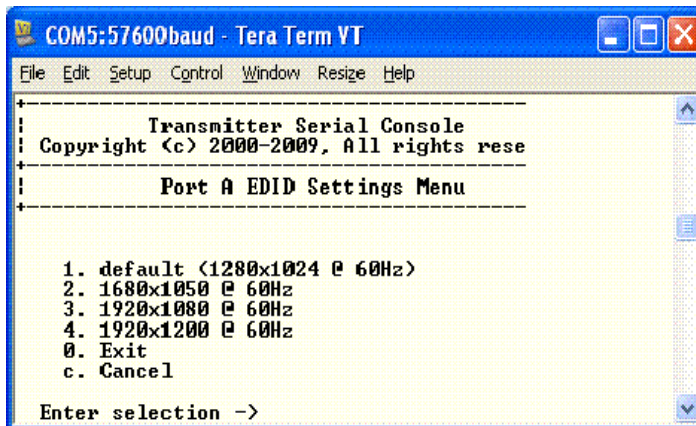

Figure 3.32: EDID Settings Menu

5. Enter the number that represents the desired preferred timing, enter **0** (zero) to Exit/Apply Changes or enter **c** to Cancel.

Session retry settings

The HMX user station is designed to automatically establish a connection between the HMX user station and the remote workstation. By default, if the HMX user station cannot immediately establish a connection with the remote workstation it will retry once per second until a connection is successfully established. You can change the default session retry settings using the serial menu.

To access the Session Retry Menu:

1. Press **Enter** to display the serial menu.

2. Press **1** to access the Receiver Main menu and press **Enter**. If the password option is enabled, you will be prompted for a password.
3. Press **8** to access the Console Settings Menu and press **Enter**.
4. Press **1** to access the Session Retry Menu and press **Enter**.

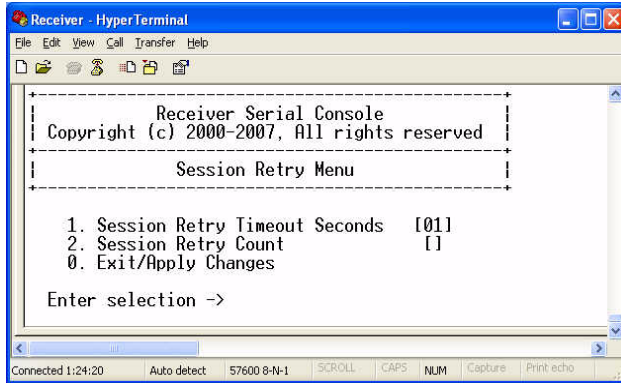

Figure 3.33: Session Retry Menu

To change the retry settings:

1. Access the Session Retry Menu via the serial menu as described above.
2. To change the time interval between retry attempts, press **1** to choose the Session Retry Timeout Seconds option and press **Enter**. You will be prompted to enter a new time-out value in SS (seconds) format.
3. Type a value between 1 and 60 (inclusive) and press **Enter**.
4. To confirm your selection and exit the screen, type **0** (zero) and press **Enter**.

Configuring the OSD Hotkey Sequence

To change the hotkey sequence that activates your OSD:

1. From the serial menu, press **1** to access the Receiver Main Menu and press **Enter**. If the password option is enabled, you will be prompted for a password.
2. Press **8** to access the Console Settings Menu. The Console Settings Menu will appear. Your currently selected OSD hotkey sequence is displayed beside menu item 1.

NOTE: The layout of the Console Settings Menu is different for the Desktop and Extender modes. In this example, the screen is in Extender Mode.

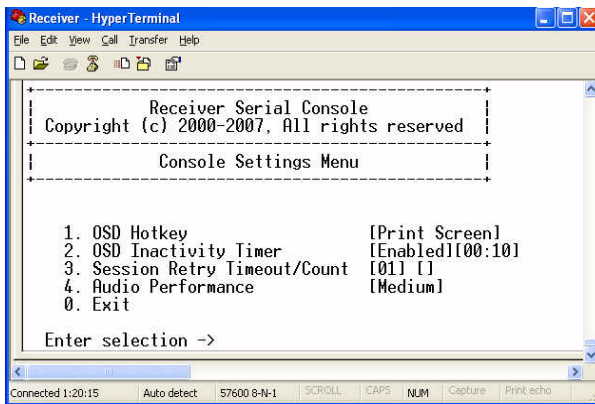

Figure 3.34: Receiver Console Settings Menu (Extender Mode)

- Press **1** to access the OSD Hotkey Menu and press **Enter**. The OSD Hotkey Menu will appear. This menu shows you the hotkey sequences that you can choose from. The current hotkey sequence is indicated by an asterisk (*).

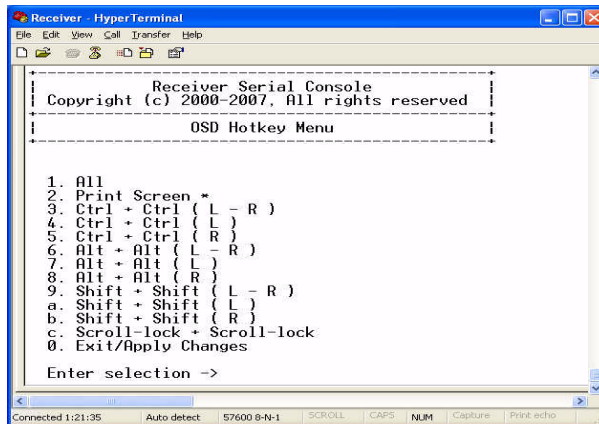

Figure 3.35: OSD Hotkey Menu

- Type the number that corresponds to the hotkey sequence you wish to apply and press **Enter**.

- To confirm your selection and exit the screen, type **0** (zero) and press **Enter**.

Table 3.2: OSD Hotkey Sequences

Hotkey Sequences	
All	Print Screen (Default)
Ctrl + Ctrl (L - R)	Ctrl + Ctrl (L)
Ctrl + Ctrl (R)	Alt + Alt (L - R)
Alt + Alt (L)	Alt + Alt (R)
Shift + Shift (L - R)	Shift + Shift (L)
Shift + Shift (R)	Scroll Lock + Scroll Lock

OSD Inactivity Time-out

By default, the HMX user station is configured to dismiss the OSD after an inactivity period of 10 minutes. To reactivate the OSD, you must enter a valid OSD hotkey sequence.

Using the serial menu, you can disable the OSD time-out or change the time-out period to any value between zero minutes and 10 hours. Setting the time-out period to zero means that the OSD will not time out. The maximum time-out period that can be configured is 9 hours and 59 minutes.

NOTE: You can dismiss the OSD at any time by pressing **ESC**.

To change the OSD time-out period:

- From the serial menu, press **1** to access the Receiver Main Menu and press **Enter**. If the password option is enabled, you will be prompted for a password. Press **8** to access the Console Settings Menu and press **Enter**. The current OSD time-out configuration is displayed beside menu item 2.

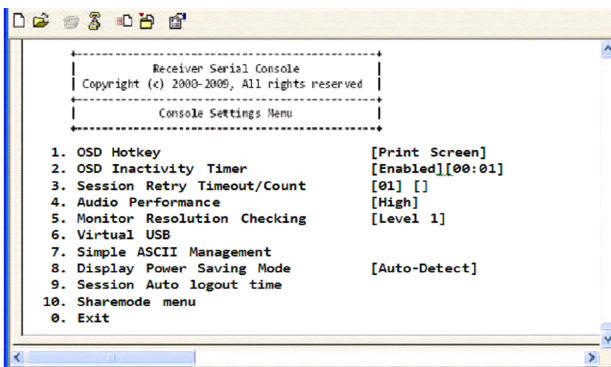

Figure 3.36: Receiver Console Settings Menu

- Press **2** to access the OSD Inactivity Timer and press **Enter**.

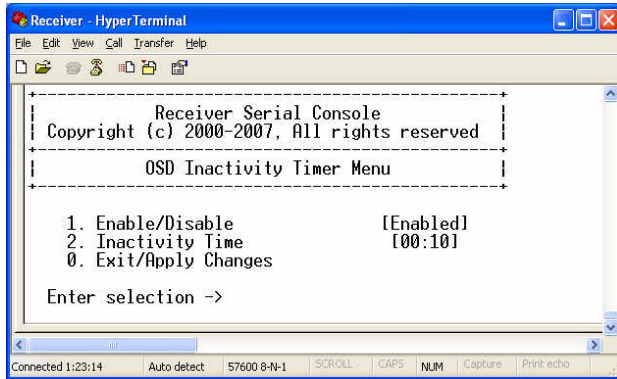

Figure 3.37: OSD Inactivity Timer Menu

- Press **2** to choose Inactivity Time and press **Enter**. You will be prompted to enter a time-out period in the format hours:minutes (HH:MM). The maximum time-out period you can enter is 9 hours and 59 minutes (09:59).
- Enter the time-out period and press **Enter**.
- To confirm your selection and exit the screen, type **0** (zero) and press **Enter**.

NOTE: To disable the OSD time-out, choose *Disable* in the OSD Inactivity Timer Menu.

Audio Performance Settings

You can use this option to modify the audio performance settings or to disable audio support. There are three settings available: high, medium and off. The high setting provides the best audio performance and should be used when high network bandwidth is available. The medium setting should be used if network bandwidth is limited or if the network latency is high. If you choose *off*, audio support will be disabled.

NOTE: To ensure that audio operates correctly, configure the user station and the transmitter with identical audio performance settings.

To change the audio performance setting for the transmitter:

- From the serial menu, press **2** to access the Transmitter Main Menu and press **Enter**. If the password option is enabled, you will be prompted for a password.
- Press **8** to access the Console Settings Menu and press **Enter**. The current audio performance setting is displayed beside menu item 3.

- Press **3** to access the Audio Performance Menu and press **Enter**. The Audio Performance Menu shows you the audio settings that you can choose from. The current setting is indicated by an asterisk symbol (*).

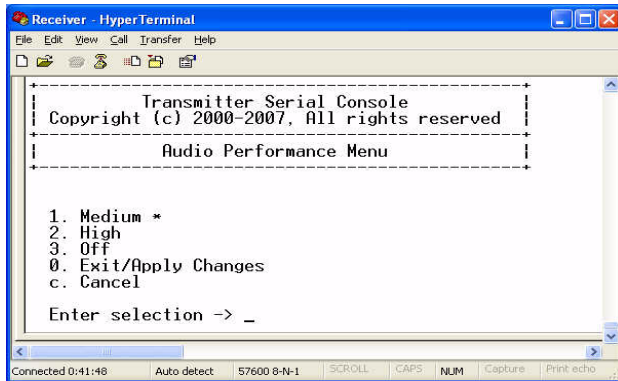

Figure 3.38: Transmitter Audio Performance Menu

- Type the number that corresponds to the audio setting you wish to apply and press **Enter**.
- To confirm your selection and exit the screen, type **0** (zero) and press **Enter**. The unit resets after you press **Enter**.

To change the audio performance setting for the HMX user station:

- From the serial menu, press **1** to access the Receiver Main Menu and press **Enter**. If the password option is enabled, you will be prompted for a password.
- Press **8** to access the Console Settings Menu and press **Enter**. The current audio performance setting is displayed beside menu item 4.
- Press **4** to access the Audio Performance Menu and press **Enter**. This menu shows you the audio settings that you can choose from. The current setting is indicated by an asterisk.

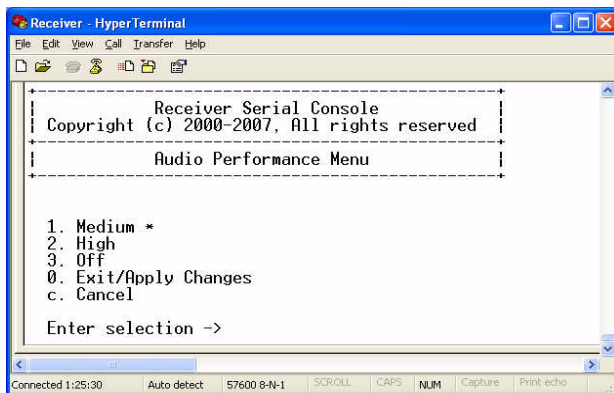

Figure 3.39: Receiver Audio Performance Menu

4. Type the number that corresponds to the audio setting you wish to apply and press **Enter**.

NOTE: If you choose *off*, audio support will be disabled.

5. To confirm your selection and exit the screen, type **0** (zero) and press **Enter**. The unit resets after you press **Enter**.

Display power saving mode

By accessing the HMX Manager appliance, you can set and display the power saving mode feature.

To set up the display power saving mode feature:

1. From the serial menu, press **1** to access the Receiver Main Menu and press **Enter**. If the password option is enabled, you will be prompted for a password. Press **8** to access the Console Settings Menu and press **Enter**. The current Power Saving configuration is displayed.
2. Press **8** to choose Display Power Saving Mode, then press **Enter**. The Display Power Saving Mode Menu will appear.

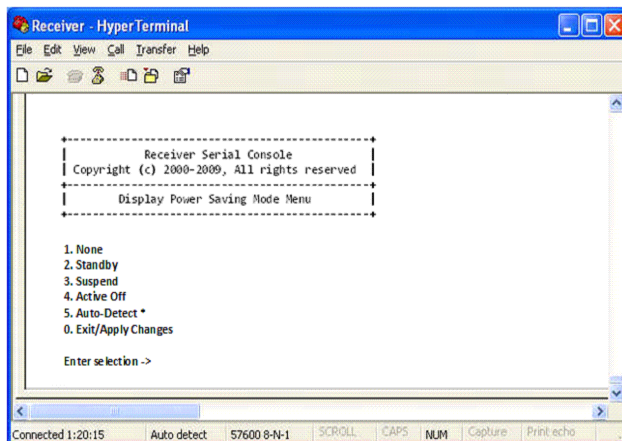

Figure 3.40: Display Power Saving Mode Menu

3. Enter the number representing the desired mode from the menu.
4. To confirm your selection and exit the screen, type **0** (zero) and press **Enter**.

Setting the Auto Logout Timeout (Serial Menu)

If there is no keyboard or mouse activity for an amount of time greater than the value set in the Auto Logout Timeout, the user station will automatically disconnect from the transmitter and log off from the HMX Manager.

1. From the serial menu, press **1** to access the Receiver Main Menu and press **Enter**. If the password option is enabled, you will be prompted for a password. Press **8** to access the Console Settings Menu and press **Enter**. The current session Auto logout is displayed beside menu item 9.

2. Enter **9** to choose Session Auto logout time, then press **Enter**. The Session Auto Logout Menu opens.

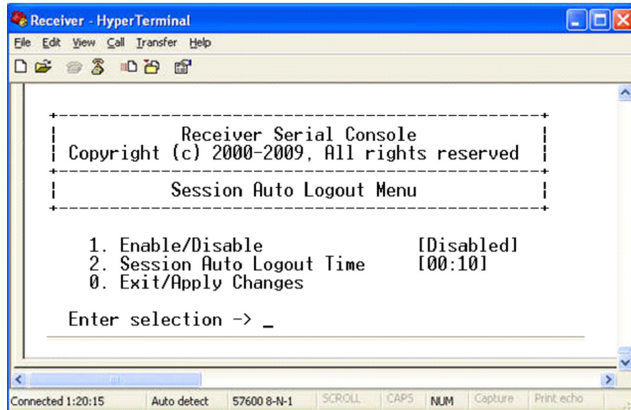

Figure 3.41: Session Auto Logout Menu

3. To enable or disable the logout timer, enter **1** to toggle back and forth. The screen will be refreshed with the new setting.
4. Enter **2** to change the logout timer. You will be prompted to enter a time-out period in the format hours:minutes (HH:MM). The maximum time-out period you can enter is 9 hours and 59 minutes (09:59).
5. Enter the time-out period then press **Enter**. To exit the menu apply changes, type **0** (zero) and press **Enter**.

Using Share Mode

Share Mode allows multiple users (up to eight user stations per transmitter) to share the audio and video of a target computer over the network and arbitrate for control of that computer. Share Mode is intended for use in either Extender Mode or Desktop Mode. HMX user stations and transmitters configured for Share Mode and for non-Share Mode can co-exist on the same network.

NOTE: For Share Mode to operate in Desktop Mode, HMX Manager software and HMX user station and transmitter firmware version equal to or higher than 4.x.x.x is required. The HMX Manager software has to be upgraded before the HMX user stations and transmitters are upgraded. HMX Manager appliances running firmware version 4.x.x.x are capable of discovering and upgrading HMX user stations and transmitters running firmware 3.3.x.x.

Your Share Mode capabilities will depend on the firmware version of your HMX user stations and transmitters.

- If you are running firmware version 4.x.x.x or higher, your HMX user stations, transmitters and HMX Manager appliances are Share Mode capable. Once the HMX Manager software has been upgraded to version 4.x.x.x or higher, both Share Mode and non-Share Mode user stations and transmitters must upgrade to firmware version 4.x.x.x or higher.
- If you are running firmware version 4.x.x.x, only the HMX 1070 user station, HMX 2050 user station, HMIQSHDI transmitter and HMIQDHDD transmitter are Share Mode capable.

NOTE: If HMX 1050 user stations and transmitters are upgraded to firmware version 4.x.x.x, they can operate in Private Mode alongside HMX user stations and transmitters operating in Share Mode, but they cannot share.

Using a USB device with Share Mode

Only the first user station connected to a target is allowed to use a vUSB or vMedia device (other than the keyboard and mouse).

Keyboard and mouse control during Share Mode

Initially, the first user (User A) to log onto a server has keyboard and mouse control. Subsequent users that log on can access video and audio. However, until User A relinquishes control, no subsequent users have keyboard and mouse control.

If User A does not move the mouse or type on the keyboard for more than one second, control may be relinquished. User B can obtain control by typing or moving the mouse.

Audio and video quality

Share Mode does not affect sound or video quality to any connected user.

Configuration

Share Mode can be configured from the HMX Manager, or when in Extender Mode it can be configured from the serial menu.

Network requirements

Using the HMX extender system in Share Mode requires IGMP protocol version 2 or higher network capabilities. In addition, all Ethernet switches to which the HMX user stations, transmitters or HMX Manager appliances are connected must be capable of observing the IGMP traffic in order to determine which units to communicate with (IGMP snooping). Transmitters in Share Mode send out multicast IP packets to the Ethernet switch. If the switch used is not capable of IGMP snooping, the switch will broadcast the packets to every port, causing undesirable results.

Monitor requirements

Each monitor attached to a user station has to be capable of displaying the same resolution and frequency that all the other monitors in the share group use.

Using Share Mode in Desktop Mode

Share Mode is available to HMX user stations configured for Desktop Mode via the HMX Manager software.

NOTE: The following procedure assumes that the transmitter connected to the target has been configured for Share Mode. In Desktop Mode, the transmitter is configured for Share Mode by the HMX Manager software. See the HMX Manager Installer/User Guide for more information.

To make a Share Mode connection in Desktop Mode:

1. Press **Print Screen** and select the *User* tab to display user information for your HMX user station.
2. Click on the *Target* tab.
3. From the list of servers available for connection on the Target tab in the user station's OSD, select the server with which a connection is desired.

4. Click *Connect*.

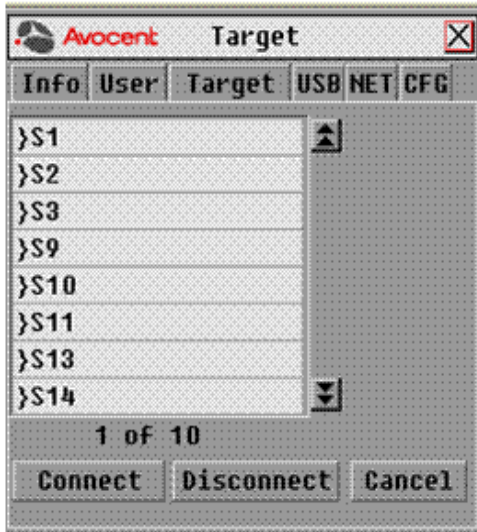

Figure 4.1: Target Menu

Using Share Mode in Extender Mode

Share Mode will operate with the HMX user stations configured for Extender Mode. In Extender Mode, normally there would not be an HMX Manager appliance in the system.

Connecting

From a user station, three steps are required to make a Share Mode connection with a Share Mode enabled transmitter:

NOTE: It is recommended that the IP address and Share Mode settings of each user station are configured before adding them to the network.

- Via the serial port of the user station, set the transmitter for Share Mode connection.
- Via the serial port of the user station, set the user station for Share Mode connection.
- On the user station, enter the IP address of the transmitter with which a connection is desired. To configure this option on the user station, see *Configuring Network Settings* on page 33.

NOTE: Repeat the last two steps for each user station that you wish to connect to the transmitter.

Configuring

In order to use Share Mode in Extender Mode, Share Mode must be enabled from both the transmitter's serial menu and the user station's serial menu. Once a transmitter is enabled for Share Mode, multiple user stations can connect with the transmitter.

To enable Share Mode on the transmitter:

1. From the user station's serial menu, press **2** to access the Transmitter Main Menu and press **Enter**. If the password option is enabled, you will be prompted for a password.
2. Press **7** to access the Console Settings Menu and press **Enter**. The Console Settings Menu will display.

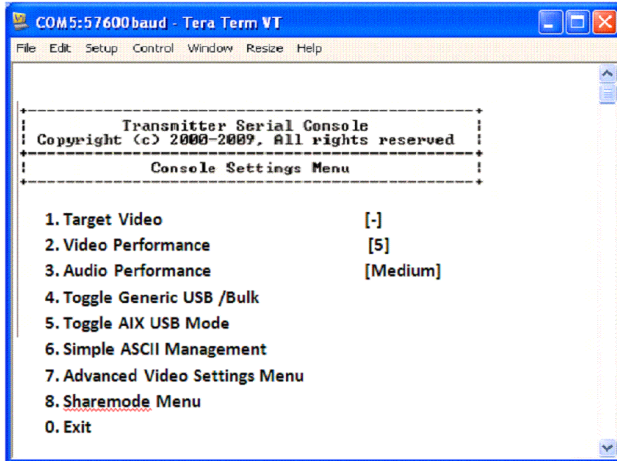
**Figure 4.2: Transmitter Console Settings Menu**

3. Press **8** to access the Share Mode menu.
4. To enable or disable Share Mode, select option **1** and toggle back and forth.
5. Press **0** (zero) to exit and apply changes.

To enable Share Mode on the user station:

1. From the serial menu, press **1** to access the Receiver Main Menu and press **Enter**. If the password option is enabled, you will be prompted for a password.
2. Press **8** to access the Console Settings Menu and press **Enter**. The Console Settings Menu will display.
3. Press **11** to access the Share Mode menu.
4. Press **1** to select the connection type.
5. To enable or disable Share Mode, select option **2**.
6. Press **0** (zero) to exit and apply changes.

Advanced Operations

Simple ASCII Manager Interface

The HMX extender system features a Simple ASCII Manager Interface (SAMI) that allows you to have limited control over your HMX transmitters and user stations via an ASCII-based protocol delivered via TCP. The password protected SAMI is enabled over the serial port on your HMX extender system and operates in Extender Mode only. The SAMI supports the following commands:

- set - The set command will be used to set a parameter to a specified value.
- get - The get command will be used to retrieve the value of a parameter.
- use - The use command will be used to perform an action which does not change the value of a parameter. For example, to initiate a session, the user must send the password with the use command (“use password sessionpassword”).
- resp - The resp command will be used to respond to a request from the client.
- error - The user station will respond with the error command when an invalid message is received. The format of the error response is “error command parameter failure.” If a specific error can be identified, the user station will return that error.

The following table describes the parameters that can be utilized through the SAMI.

Table 5.1: SAMI Parameters and Descriptions

Parameter	Description	Type	Example
password	The password initiates a management session. Once the session is initiated, any other commands may be used. The session will close when the time-out expires. The password can only be set using the serial port.	use	use password sessionpassword resp connect
reset	The reset parameter resets a user station. There are certain cases where the user station must be reset for the parameter to take effect.	use	use reset
disconnect	The disconnect parameter disconnects the manager from the user station. There is no response to this message.	use	use disconnect
ipaddr	IP address of the managed device. Changing ipaddr requires a use reset command after the response is received to be active.	set, get	set IpAddr 192.168.13.1 resp IpAddr 192.168.13.1 get IpAddr resp IpAddr 192.168.13.1
netmask	Netmask of the managed device. Changing netmask requires a use reset command after the response is received to be active.	set, get	set netmask 255.255.255.0 resp netmask 255.255.255.0 get netmask resp netmask 255.255.255.0
gateway	Default gateway of the managed device. Changing gateway requires a use reset command after the response is received to be active.	set, get	set gateway 192.168.13.1 resp gateway 192.168.13.1 get gateway resp gateway 192.168.13.1
partneripaddr	The IP address of the partner. This parameter only applies to the user station. It is the IP address of the transmitter that the user wants to connect to. There is a slight delay to switch partners, but no reset is needed.	set, get	set partnerIpAddr 192.168.13.2 resp partnerIpAddr 192.168.13.2 get partnerIpAddr resp partnerIpAddr 192.168.13.2
name	The user station name of the device. No reset is needed.	set, get	get name resp name "Malta DIP" set name "Malta DIP" resp name "Malta DIP"
eid	The user station EID of the device.	get	get eid resp eid 510150-00032D-000 set eid 510150-00032D-000 resp eid 510150-00032D-000
mac	The mac address of the device.	get	get mac resp mac 00:E0:86:0E:31:73

Accessing the SAMI Menu

To access the SAMI Menu, navigate to the Console Settings menu, press **7** and then press **Enter**. This menu shows you the editable SAMI settings, current port number and SAMI time-out settings.

New settings to the SAMI are not applied until after entering **0** to exit/apply changes. For proper operation, once a command is sent, wait for a response before another command is sent. Each command must be encapsulated in a single TCP/IP packet.

NOTE: The SAMI is disabled by default and uses **password** as the default password.

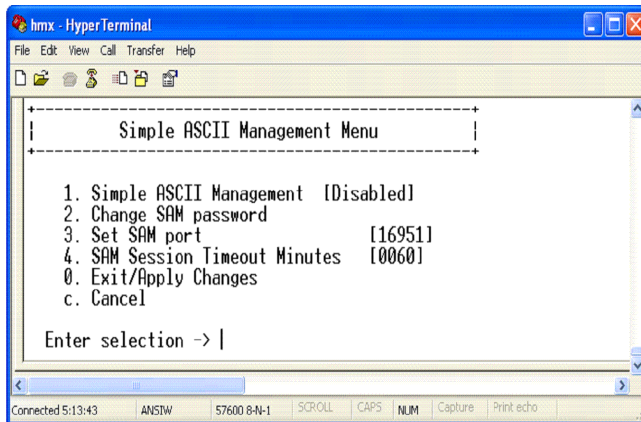

Figure 5.1: SAMI Menu

To configure the following on the SAMI Menu:

- To enable or disable the SAMI, select option **1** to toggle back and forth. The screen will be refreshed with the new setting.
- To change the default password, select option **2** and enter your new password. You will be prompted to re-enter your password. Press **Enter** to complete this process.
- To change the port number (between 1024 and 65535), select option **3**.
- To enter the session time-out time (in minutes), select option **4**.
- Press **0** (zero) to exit and apply changes, or press **c** to cancel the changes, if any.

Example Session

Send the use password password command terminated by a line feed (the response should be resp connect).

Enter the **get ipaddr** command (the response should be resp ipaddr 192.168.13.7).

NOTE: In this example, the IP address of the managed unit is 192.168.13.7

NOTE: Before a changed IP address, gateway or subnet address becomes active, the **use reset** command has to be entered. Being able to read the new address with a get command before sending use reset does command not necessarily mean the new address is applied and active.

APPENDICES

Appendix A: Technical Specifications

NOTE: During the course of this product's lifetime, modifications might be made to its hardware or firmware that could cause these specifications to change without notice.

Table A.1: HMX 1070 and HMX 2050 User Station Product Specifications

Network	
Ethernet Standard	Ethernet II
IP Port Usage	Port 16384 - Video Port 16388 - Video Port 16385 - Audio Port 16386 - Keyboard\Mouse Port 16387 - vMedia Ports 4463, 4464, 4465 - Control
Extension Ports	
Number	1
Connectors	RJ-45
User Ports	
Number	USB: 4; DVI-I video: 2; audio line-out: 1; power jack: 1 (HMX 2050 user station) USB: 4; DVI-D video: 1; VGA video: 1; audio line-out: 1; power jack: 1 (HMX 1070 user station)
Type	USB Type A, DVI-I video
Connectors	USB Type A, USB keyboard and mouse; DVI-I, female; 3.5 mm stereo audio jack, line out; 2.5 mm DC power jack
Encryption	
Type	Authenticated SSL
Console Port	
Number	1

Table A.1: HMX 1070 and HMX 2050 User Station Product Specifications (Continued)

Type	Three-wire serial interface: RX, TX, GND via 16450-compatible UART
Connectors	9-pin D-Shell (DB9)
Dimensions	
H x W x D	28 x 210 x 140 mm (1.10 x 8.27 x 5.51 in)
Weight	0.95 Kg (2.09 lb) without packaging, cables, power supply and literature
Environmental	
Heat Dissipation	22 W/H
Power Consumption	20 W (including power supplied to USB ports)
AC-input power	100-240 VAC
AC-input current rating	1 A
AC-frequency	50/60 Hz
Operating Temperature	0° to 35° Celsius (32° to 95° Fahrenheit)
Storage Temperature	-20° to 60° Celsius (-4° to 140° Fahrenheit)
Transit Temperature	-30° to 60° Celsius (-22° to 140° Fahrenheit)
Operating Humidity	10 to 90% noncondensing
Storage Humidity	5 to 95%
Supported Hardware	
Peripherals	USB keyboard and mouse, speakers
Keyboard	Standard 104/105/109 keyboards for PC, Macintosh and Sun; USB keyboards for PC, Macintosh and Sun; Default keyboard drivers are fully supported for Microsoft Windows, Mac OS, Solaris and Red Hat® Linux
Mouse	2-, 3-, and 5-button; scroll and tilt wheel

Table A.1: HMX 1070 and HMX 2050 User Station Product Specifications (Continued)

Mass Storage Devices	<p>All Mass Storage Class devices that use: SCSI mass storage subclass Bulk only transfer protocol Printers Touch screens Pen tablets Smart card readers Digital sign pads Joysticks</p> <p>NOTE: Check with your Avocent representative for the latest list of devices that have been tested and verified on the HMX system.</p>
Video Resolution	<p>640 x 350 @ 85 Hz 640 x 480 @ 60 Hz, 72 Hz, 75 Hz, 85 Hz 720 x 400 @ 70 Hz, 85 Hz 720 x 480 @ 60 Hz 800 x 600 @ 60 Hz, 72 Hz, 75 Hz, 85 Hz 1024 x 768 @ 60 Hz, 70 Hz, 75 Hz, 85 Hz 1152 x 864 @ 75 Hz 1280 x 960 @ 60 Hz 1280 x 1024 @ 60 Hz 1600 x 1200 @ 60 Hz 1680 x 1050 @ 60 Hz</p> <p>The following widescreen resolutions are also supported: 1360 x 768 @ 60 Hz 1280 x 720 @ 50 Hz, 60 Hz 1440 x 900 @ 60 Hz 1920 x 1154 @ 50 Hz (DVI monitor only) 1920 x 1200 @ 60 Hz (DVI monitor only)</p> <p>NOTE: The 1280 x 720 resolutions are the VESA CRT computer resolutions, not the EIA 720p60 TV resolutions.</p>
Video Standard	DDC version 2B
Color Depth	24 Bit
Audio Standard	PC99
Audio Performance	
High Performance	<p>Line-out: 44.1 kHz over stereo channels at a resolution of 16 bits</p>
Medium Performance	<p>Line-out: 8 kHz over stereo channels at a resolution of 16 bits</p>
Target Sync Types (Analog output only)	Separate horizontal and vertical

Table A.1: HMX 1070 and HMX 2050 User Station Product Specifications (Continued)

Safety and EMC Approvals and Markings	UL, FCC, cUL, VCCI, C-Tick, CE
--	--------------------------------

Table A.2: HMIQDHDD and HMIQSHDI Transmitter Specifications

Network	
Ethernet Standard	Ethernet II
Extension Ports	
Number	1
Connectors	RJ-45
Console Ports	
Number	USB: 1; DVI-I video: 2; audio line-out: 1(HMIQDHDD transmitter) USB: 1; DVI-D video: 1; VGA video:1 audio line-out: 1 (HMIQSHDI transmitter)
Type	USB Type A, DVI-D video
Connectors	USB, male; DVI-I, male; 3.5 mm stereo audio jack, 2.5 mm DC power jack (HMIQDHDD) USB, male; DVI-D, male; VGA; male; 3.5 mm stereo audio jack, 2.5 mm DC power jack (HMIQSHDI transmitter)
Encryption	
Type	Authenticated SSL
Dimensions	
H x W x D	28 x 127 x 200 mm (1.10 x 5.00 x 7.87 in)
Weight	0.75 Kg (1.65 lb) including cables
Environmental	
Heat Dissipation	22 W/H
Power Consumption	20 W
AC-input power	100-240 VAC
AC-input current rating	1 A
AC-frequency	50/60 Hz
DC-input power	5 V

Table A.2: HMIQDHDD and HMIQSHDI Transmitter Specifications (Continued)

DC-input current rating	1.1 A
Operating Temperature	0° to 35° Celsius (32° to 95° Fahrenheit)
Storage Temperature	-20° to 60° Celsius (-4° to 140° Fahrenheit)
Transit Temperature	-30° to 60° Celsius (-22° to 140° Fahrenheit)
Operating Humidity	10 to 90% noncondensing
Storage Humidity	5 to 95%
Supported Hardware	
Network	
Ethernet Standard	Ethernet II
Extension Ports	
Number	1
Connectors	RJ-45
Console Ports	
Number	USB: 1; DVI-I video: 2; audio line out: 1
Type	USB Type A, DVI-D video
Connectors	USB, male; DVI-I, male; 3.5 mm stereo audio jack, 2.5 mm DC power jack.
Encryption	
Video Resolution	<p>640 x 350 @ 85 Hz 640 x 480 @ 60 Hz, 72 Hz, 75 Hz, 85 Hz 720 x 400 @ 70 Hz, 85 Hz 720 x 480 @ 60 Hz 800 x 600 @ 60 Hz, 72 Hz, 75 Hz, 85 Hz 1024 x 768 @ 60 Hz, 70 Hz, 75 Hz, 85 Hz 1152 x 864 @ 75 Hz 1280 x 960 @ 60 Hz 1280 x 1024 @ 60 Hz 1600 x 1200 @ 60 Hz 1680 x 1050 @ 60 Hz The following widescreen resolutions are also supported: 1360 x 768 @ 60 Hz 1280 x 720 @ 50 Hz, 60 Hz 1440 x 900 @ 60 Hz 1920 x 1154 @ 50 Hz (DVI computer only) 1920 x 1080 @ 50 Hz (DVI-D computers only) 1920 x 1200 @ 60 Hz (DVI-D computers only)</p>

Table A.2: HMIQD HDD and HMIQSHDI Transmitter Specifications (Continued)

Video Standard	DDC version 2B
----------------	----------------

Table A.3: HMX 1050 User Station Product Specifications

Network	
Ethernet Standard	Ethernet II
IP Port Usage	Port 16384 - Video Port 16385 - Audio Port 16386 - Keyboard\Mouse Port 16387 - vMedia Ports 4463, 4464, 4465 - Control
Extension Ports	
Number	1
Connectors	RJ-45
User Ports	
Number	PS/2: 2; USB: 4; DVI-I video: 1; audio microphone: 1; audio line out: 1; power jack: 1
Type	PS/2, USB Type A, DVI-I video
Connectors	6-pin miniDIN, PS/2 keyboard and mouse; USB Type A, USB keyboard and mouse; DVI-I, female; 3.5 mm stereo audio jacks, line-out and mic; 2.5 mm DC power jack
Encryption	
Type	Authenticated SSL
Console Port	
Number	1
Type	Three-wire serial interface: RX, TX, GND via 16450-compatible UART
Connectors	9-pin D-Shell (DB9)
Dimensions	
H x W x D	28 x 210 x 130 mm (1.04 x 8.27 x 5.12 in)
Weight	0.7 Kg (1.54 lb) without packaging, cables, power supply and literature
Environmental	
Heat Dissipation	22 W/H
Power Consumption	20 W (including power supplied to USB ports)
AC-input power	100-240 V AC

Table A.3: HMX 1050 User Station Product Specifications (Continued)

AC-input current rating	1 A
AC-frequency	50/60 Hz
Operating Temperature	0° to 35° Celsius (32° to 95° Fahrenheit)
Storage Temperature	-20° to 60° Celsius (-4° to 140° Fahrenheit)
Transit Temperature	-30° to 60° Celsius (-22° to 140° Fahrenheit)
Operating Humidity	10 to 90% noncondensing
Storage Humidity	5 to 95%
Supported Hardware	
Peripherals	PS/2 keyboard and mouse, USB keyboard and mouse, speakers, microphone
Keyboard	Standard 104/105/109 keyboards for PC, Macintosh, and Sun; USB keyboards for PC, Macintosh and Sun; Default keyboard drivers are fully supported for Microsoft Windows, Mac OS, Solaris and Red Hat® Linux
Mouse	2-, 3-, and 5-button; scroll and tilt wheel
Mass Storage Devices	All Mass Storage Class devices that use: SCSI mass storage subclass Bulk only transfer protocol Printers Touch screens Pen tablets Smart card readers Digital sign pads Joysticks NOTE: Check with your Avocent representative for the latest list of devices that have been tested and verified on the HMX system.

Table A.3: HMX 1050 User Station Product Specifications (Continued)

Video Resolution	<p>640 x 350 @ 85 Hz 640 x 480 @ 60 Hz, 72 Hz, 75 Hz, 85 Hz 720 x 400 @ 70 Hz (85 Hz DVI only) 800 x 600 @ 60 Hz, 72 Hz, 75 Hz, 85 Hz 1024 x 768 @ 60 Hz, 70 Hz, 75 Hz, 85 Hz 1152 x 864 @ 75 Hz 1280 x 960 @ 60 Hz 1280 x 1024 @ 60 Hz The following widescreen resolutions are also supported: 1360 x 768 @ 60 Hz 1280 x 720 @ 50 Hz 1280 x 720 @ 60 Hz NOTE: The 1280 x 720 resolutions are the VESA CRT computer resolutions, not the EIA 720p60 TV resolutions.</p>
Video Standard	DDC version 2B
Color Depth	24 Bit
Audio Standard	PC99
Audio Performance	
High Performance	<p>Line-out: 44.1 kHz over stereo channels at a resolution of 16 bits Microphone: 44.1 kHz over a single channel at a resolution of 16 bits</p>
Medium Performance	<p>Line-out: 8 kHz over stereo channels at a resolution of 16 bits Microphone: 8 kHz over a single channel at a resolution of 16 bits</p>
Target Sync Types (Analog output only)	Separate horizontal and vertical
Safety and EMC Approvals and Markings	UL, FCC, cUL, VCCI, C-Tick, CE

Table A.4: HMIQDI Transmitter Product Specifications

Network	
Ethernet Standard	Ethernet II
Extension Ports	
Number	1
Connectors	RJ-45
Console Ports	
Number	USB: 2; DVI-I video: 1; audio microphone: 1; audio line-out: 1
Type	USB Type A, DVI-I video
Connectors	USB, male; DVI-I, male; 3.5 mm stereo audio jacks, line-out and mic; 2.5 mm DC power jack
Encryption	
Type	Authenticated SSL
Dimensions	
H x W x D	68 x 21 x 153 mm (2.68 x 0.83 x 6.02 in)
Weight	0.3 Kg (0.66 lb) including cables
Environmental	
Heat Dissipation	22 W/H
Power Consumption	6 W
AC-input power	100-240 VAC
AC-input current rating	1 A
AC-frequency	50/60 Hz
DC-input power	5 V
DC-input current rating	1.1 A
Operating Temperature	0° to 35° Celsius (32° to 95° Fahrenheit)
Storage Temperature	-20° to 60° Celsius (-4° to 140° Fahrenheit)
Transit Temperature	-30° to 60° Celsius (-22° to 140° Fahrenheit)
Operating Humidity	10 to 90% noncondensing
Storage Humidity	5 to 95%

Table A.4: HMIQDI Transmitter Product Specifications (Continued)

Supported Hardware	
Video Resolution	640 x 350 @ 85 Hz 640 x 480 @ 60 Hz, 72 Hz, 75 Hz, 85 Hz 720 x 400 @ 70 Hz (85 Hz DVI only) 800 x 600 @ 60 Hz, 72 Hz, 75 Hz, 85 Hz 1024 x 768 @ 60 Hz, 70 Hz, 75 Hz, 85 Hz 1152 x 864 @ 75 Hz 1280 x 960 @ 60 Hz 1280 x 1024 @ 60 Hz The following widescreen resolutions are also supported: 1360 x 768 @ 60 Hz 1280 x 720 @ 50 Hz, 60 Hz
Video Standard	DDC version 2B
Color Depth	24 Bit
Audio Standard	PC99
Audio Performance	
High Performance	Line-out: 44.1 kHz over stereo channels at a resolution of 16 bits Microphone: 44.1 kHz over a single channel at a resolution of 16 bits
Medium Performance	Line-out: 8 kHz over stereo channels at a resolution of 16 bits Microphone: 8 kHz over a single channel at a resolution of 16 bits
Target Sync Types (Analog input only)	Separate horizontal and vertical
EDID table settings	Normal aspect or wide screen resolutions
Safety and EMC Approvals and Markings	UL, FCC, cUL, VCCI, C-Tick, CE

Appendix B: Factory Default Settings

Table B.1: HMX System Factory Defaults

HMX 1050, HMX 1070 and HMX 2050 User Stations	
Name	RX_<MAC address>
IP Address	192.168.13.1
Default Gateway	0.0.0.0
Netmask	255.255.255.0
OSD Hotkey Sequence	Print Screen
OSD Inactivity Timer	00 hours 10 minutes
OSD Inactivity Checkbox	Enabled
Session Inactivity Timer	00 hours 10 minutes
Session Inactivity Checkbox	Disabled
Session Retry Time-out	1 second
Audio Performance	Medium
Network Speed	Auto-Negotiate
Password	password
Appliance Mode	Extender
Static/DHCP Network Configuration	Static
HMIQDI, HMIQSHDI and HMIQDHDD Transmitters	
Name	TX_<MAC address>
IP Address	192.168.13.2
Default Gateway	0.0.0.0
Netmask	255.255.255.0
Audio Performance	Medium
Network Speed	Auto-Negotiate
HMIQDI, HMIQSHDI and HIMQDHDD Transmitters (continued)	
Password	password

Table B.1: HMX System Factory Defaults (Continued)

Video	DVI - Normal
Video Performance	5
Bandwidth Management	Unlimited
Static/DHCP Network Configuration	Static

Appendix C: Technical Support

Our Technical Support staff is ready to assist you with any installation or operating issues you encounter with your Avocent product. If an issue should develop, follow the steps below for the fastest possible service.

To resolve an issue:

1. Check the pertinent section of this manual to see if the issue can be resolved by following the procedures outlined.
2. Visit www.avocent.com/support and use one of the following resources:
Search the knowledge base or use the online service request.
-or-
Select *Technical Support Contacts* to find the Avocent Technical Support location nearest you.

Appendix D: Troubleshooting

No power status light on HMX user station

- Verify that the power supply is plugged in correctly.
- Ensure that the power cable from the Avocent-supplied power supply is securely plugged into the HMX user station.

No video on monitor attached to HMX user station

- Verify that the monitor attached to the HMX user station has power.
- Ensure that the video cable from the monitor is securely plugged in to the correct connector on the HMX user station.
- Verify that the remote computer is turned on.
- Confirm that a network connection exists between the transmitter and HMX user station.
- Verify the address of the target transmitter configured in the user station is correct.
- Confirm that the IP address used by the transmitter has not been assigned to a second device on the network.
- Confirm that the IP address used by the HMX user station has not been assigned to a second device on the network.
- Verify that the transmitter is drawing sufficient power from the USB connections on the remote workstation and that it has booted correctly:
 - If the green LED on the transmitter is on, the transmitter is drawing sufficient power.
 - If the transmitter cannot draw sufficient power from the remote workstation you will need to obtain an external power supply unit for the transmitter from Avocent. If connected through a USB hub, ensure that the hub can supply enough power.
- Verify that the correct video setting has been configured in the transmitter serial menu:
 - If the remote workstation provides DVI-only video, verify that the transmitter serial menu has been configured for DVI. Then restart the remote workstation.
 - If the remote workstation provides VGA-only video, verify that the transmitter serial menu has been configured for VGA. Then restart the remote workstation.
- The transmitter has an internal fan. Verify that the fan is functioning.
- Turn the HMX user station on, then off again. An informational message should appear on the monitor for a brief moment. If the message does not appear, check the monitor by plugging the video cable from the monitor directly into the remote workstation to verify that the monitor is working and that the remote workstation is generating active video. If this is functioning, check that the display settings for your remote workstation are set no higher than a resolution of 1280 x 1024 at 60 Hz refresh rate.

- If the transmitter has been power cycled (by unplugging the USB cables), ensure that all other cables are disconnected before reconnecting the transmitter. Ensure that you connect the USB cables first.

No mouse or keyboard operation from peripherals attached to HMX user station

- Ensure that the mouse and keyboard cables are connected to the correct PS/2 or USB ports on the HMX user station.
- Ensure that both of the USB connectors from the transmitter are securely connected to the correct connectors on the remote workstation.
- If the remote workstation can provide only one USB port for the transmitter:
 - Use an external power supply for the transmitter
 - Ensure that the transmitter USB cable labeled “2” is attached to the available USB port of the remote workstation
- Ensure that the correct keyboard layout is configured on the remote workstation for the keyboard you are using.
- Retest the mouse and keyboard by connecting them directly to the remote workstation and rebooting.

No audio from speakers attached to HMX user station

- Ensure that the audio cable is securely plugged into the line-out port of the remote workstation (should be color-coded green).
- Ensure that the speaker cable is securely plugged into the line-out port of the HMX user station.
- Verify that the audio sample rate has not been set to “off” for either the transmitter or the HMX user station.
- Ensure that the same audio sample rate has been set for both the transmitter and the HMX user station.
- Verify that the speakers are turned on.
- Retest the speakers by connecting them directly to the remote workstation.

Poor sound quality from speakers attached to HMX user station

- Ensure that the same audio sample rate has been set for both the transmitter and the HMX user station.

Poor video quality on monitor attached to HMX user station

- Reset video by pressing <F11>.
- Ensure that the video cable from the monitor is securely plugged in to the correct connector on the HMX user station.

- Check the video quality using a different monitor.

No response from USB mass media device attached to the HMX user station

- Ensure that the mass media device is connected directly to one of the USB connectors on the HMX user station. If the mass media device is connected to the HMX user station via a USB hub, it will not be possible to access it.
- Ensure that both of the USB connectors from the transmitter are securely connected to the correct ports on the remote workstation.
- Verify that the mass media device is functioning correctly by attaching it to the USB port on another computer.

Slow file transfer rate from or to the USB mass media device

- Check if at least one of the transmitter USB cables is connected to a high speed USB port on the remote computer. The transmitter will operate with Low Speed and Full Speed USB, but the file transfer rate will be slower.

Connection to remote workstation is lost

- Verify that the network cable is securely connected to the RJ-45 connector on the HMX user station.
- Verify that the HMX user station is linked to the network and that it is receiving data.
- Verify that the remote computer is turned on.
- Ensure that both of the USB connectors from the transmitter are securely connected to the correct connectors on the remote workstation.
- Verify that the transmitter is drawing sufficient power from the USB connections on the remote computer and that it has booted correctly:
 - If the green LED on the transmitter is on, the transmitter is drawing sufficient power.
 - If the transmitter cannot draw sufficient power from the remote workstation, obtain an external power supply unit for the transmitter from Avocent.
- The transmitter has an internal fan. Verify that the fan is functioning.
- Ping the transmitter from another on the network to ensure it is connected.
- Reset the transmitter.
- Reset the HMX user station.
- Verify that the Ethernet network is fully operational.

Transmitter disconnected from DHCP server (Extender Mode)

- Attempt to reconnect to DHCP server (new IP address should be visible).
- Return to the Network Configuration Menu on the user station and select the Transmitter IP Address option and press **Enter**.
- Enter new IP address as specified on the DHCP server.

Transmitter disconnected from DHCP server (Matrix Mode)

To connect transmitter to DHCP server (Matrix Mode):

1. In the HMX Manager Explorer Window area, select *Units* to add a single unit.
2. Select the product without an IP address.
3. Select *No, the Transmitter does not have an address*.
4. Plug the HMIQDI transmitter into the network and turn it on.
5. Enter the network settings of the transmitter that you wish to locate.
6. Click *Save* and *Close*.

Appendix E: Login Error Messages

The following table lists error messages that may appear when using the HMX 1050 user station.

Table E.1: HMX Manager and User Station Initiated Error Messages

HMX 1050 User Station Login Error Messages	Description
Login failed User not found	User attempts to log in to the HMX Manager. The username has not been added to the internal authentication service of the HMX Manager.
Login failed Invalid password	User enters an invalid password.
Login failed User account is disabled	User account has explicitly been disabled by a HMX Manager administrator.
Login failed Target device not available	User cannot be connected to their target device. No target devices are available for the user to access.
Login failed User station is not managed by HMX Manager	User logs in from a user station that the HMX Manager does not manage. Administrator must ensure that the user station is added to the HMX Manager before a user can log in from that user station.
Login failed transmitter already in use	HMIQDI transmitter already in use. A user is attempting to log in to a target workstation; however, the HMX Manager already has a record of an active media session involving a different user who is currently using the same transmitter as part of their active media session.
Login failed user station already in use	User station already in use. A user is attempting to log in to a target workstation; however, the HMX Manager already has a record of an active media session involving a different user who is currently using the same user station as part of their active media session.
Login failed Cannot send session certificate to user station	Cannot send media session certificate to user station.
Login failed Cannot send session certificate to transmitter	Cannot send media session certificate to transmitter.
Login warning Different extender system release versions	A warning which may be received when a successful connection was made between the user station and transmitter. The warning indicates that the HMIQDI transmitter and user station have different firmware release versions.
Login failed Could not contact HMX Manager	Cannot contact HMX Manager.

Table E.1: HMX Manager and User Station Initiated Error Messages (Continued)

HMX 1050 User Station Login Error Messages	Description
Login failed HMX Manager not specified	IP address not set for HMX Manager.
Login failed Timeout	The user station access to the transmitter has timed out.
Login failed Out of service	This message appears when a login attempt is made while the user station is being upgraded.
Login failed Internal error	This message appears when the login fails but no error text is received from the HMX Manager. This should not occur during normal operation.

License Information

This product includes various software programs that are copyrighted and released under the GNU General Public License (GPL), the GNU Lesser General Public License (LGPL), and other licenses that permit copying, modification, and redistribution of source code (such licenses referred to as Public Licenses), in particular the software program “mtd”. A machine-readable copy of the source code protected by these Public Licenses is available from Avocent on a medium customarily used for software interchange for a period of three years from date of purchase of this product by contacting Avocent Corporation at www.Avocent.com/support. AVOCENT CORPORATION AND ITS LICENSORS MAKE NO WARRANTY (EXPRESS OR IMPLIED, STATUTORY OR OTHERWISE) OF ANY KIND REGARDING THE SOFTWARE PROGRAMS LICENSED UNDER ANY PUBLIC LICENSE, AND TO THE MAXIMUM EXTENT PERMITTED BY APPLICABLE LAW, AVOCENT CORPORATION AND ITS LICENSORS DISCLAIM ANY AND ALL OTHER WARRANTIES AND CONDITIONS WITH RESPECT TO THE SOFTWARE PROGRAMS LICENSED UNDER ANY PUBLIC LICENSE.

GNU GENERAL PUBLIC LICENSE Version 2, June 1991

Copyright (C) 1989, 1991 Free Software Foundation, Inc. 51 Franklin St, Fifth Floor, Boston, MA 02110-1301 USA Everyone is permitted to copy and distribute verbatim copies of this license document, but changing it is not allowed.

Preamble

The licenses for most software are designed to take away your freedom to share and change it. By contrast, the GNU General Public License is intended to guarantee your freedom to share and change free software--to make sure the software is free for all its users. This General Public License applies to most of the Free Software Foundation's software and to any other program whose authors commit to using it. (Some other Free Software Foundation software is covered by the GNU Library General Public License instead.) You can apply it to your programs, too.

When we speak of free software, we are referring to freedom, not price. Our General Public Licenses are designed to make sure that you have the freedom to distribute copies of free software (and charge for this service if you wish), that you receive source code or can get it if you want it, that you can change the software or use pieces of it in new free programs; and that you know you can do these things.

To protect your rights, we need to make restrictions that forbid anyone to deny you these rights or to ask you to surrender the rights. These restrictions translate to certain responsibilities for you if you distribute copies of the software, or if you modify it.

For example, if you distribute copies of such a program, whether gratis or for a fee, you must give the recipients all the rights that you have. You must make sure that they, too, receive or can get the source code. And you must show them these terms so they know their rights.

We protect your rights with two steps: (1) copyright the software, and (2) offer you this license which gives you legal permission to copy, distribute and/or modify the software.

Also, for each author's protection and ours, we want to make certain that everyone understands that there is no warranty for this free software. If the software is modified by someone else and passed on, we want its recipients to know that what they have is not the original, so that any problems introduced by others will not reflect on the original authors' reputations.

Finally, any free program is threatened constantly by software patents. We wish to avoid the danger that redistributors of a free program will individually obtain patent licenses, in effect making the program proprietary. To prevent this, we have made it clear that any patent must be licensed for everyone's free use or not licensed at all.

The precise terms and conditions for copying, distribution and modification follow.

GNU GENERAL PUBLIC LICENSE TERMS AND CONDITIONS FOR COPYING, DISTRIBUTION AND MODIFICATION

0. This License applies to any program or other work which contains a notice placed by the copyright holder saying it may be distributed under the terms of this General Public License. The “Program”, below, refers to any such program or work, and a “work based on the Program” means either the Program or any derivative work under copyright law: that is to say, a work containing the Program or a portion of it, either verbatim or with modifications and/or translated into another language. (Hereinafter, translation is included without limitation in the term “modification”.) Each licensee is addressed as “you”.

Activities other than copying, distribution and modification are not covered by this License; they are outside its scope. The act of running the Program is not restricted, and the output from the Program is covered only if its contents constitute a work based on the Program (independent of having been made by running the Program). Whether that is true depends on what the Program does.

1. You may copy and distribute verbatim copies of the Program's source code as you receive it, in any medium, provided that you conspicuously and appropriately publish on each copy an appropriate copyright notice and disclaimer of warranty; keep intact all the notices that refer to this License and to the absence of any warranty; and give any other recipients of the Program a copy of this License along with the Program.
You may charge a fee for the physical act of transferring a copy, and you may at your option offer warranty protection in exchange for a fee.
2. You may modify your copy or copies of the Program or any portion of it, thus forming a work based on the Program, and copy and distribute such modifications or work under the terms of Section 1 above, provided that you also meet all of these conditions:
 - a. You must cause the modified files to carry prominent notices stating that you changed the files and the date of any change.
 - b. You must cause any work that you distribute or publish, that in whole or in part contains or is derived from the Program or any part thereof, to be licensed as a whole at no charge to all third parties under the terms of this License.
 - c. If the modified program normally reads commands interactively when run, you must cause it, when started running for such interactive use in the most ordinary way, to print or display an announcement including an appropriate copyright notice and a notice that there is no warranty (or else, saying that you provide a warranty) and that users may redistribute the program under these conditions, and telling the user how to view a copy of this License. (Exception: if the Program itself is interactive but does not normally print such an announcement, your work based on the Program is not required to print an announcement.)

These requirements apply to the modified work as a whole. If identifiable sections of that work are not derived from the Program, and can be reasonably considered independent and separate works in themselves, then this License, and its terms, do not apply to those sections when you distribute them as separate works. But when you distribute the same sections as part of a whole which is a work based on the Program, the distribution of the whole must be on the terms of this License, whose permissions for other licensees extend to the entire whole, and thus to each and every part regardless of who wrote it.

Thus, it is not the intent of this section to claim rights or contest your rights to work written entirely by you; rather, the intent is to exercise the right to control the distribution of derivative or collective works based on the Program.

In addition, mere aggregation of another work not based on the Program with the Program (or with a work based on the Program) on a volume of a storage or distribution medium does not bring the other work under the scope of this License.

3. You may copy and distribute the Program (or a work based on it, under Section 2) in object code or executable form under the terms of Sections 1 and 2 above provided that you also do one of the following:
 - a. Accompany it with the complete corresponding machine-readable source code, which must be distributed under the terms of Sections 1 and 2 above on a medium customarily used for software interchange; or,
 - b. Accompany it with a written offer, valid for at least three years, to give any third party, for a charge no more than your cost of physically performing source distribution, a complete machine-readable copy of the corresponding source code, to be distributed under the terms of Sections 1 and 2 above on a medium customarily used for software interchange; or,
 - c. Accompany it with the information you received as to the offer to distribute corresponding source code. (This alternative is allowed only for noncommercial distribution and only if you received the program in object code or executable form with such an offer, in accord with Subsection b above.)

The source code for a work means the preferred form of the work for making modifications to it. For an executable work, complete source code means all the source code for all modules it contains, plus any associated interface definition files, plus the scripts used to control compilation and installation of the executable. However, as a special exception, the source code distributed need not include anything that is normally distributed (in either source or binary form) with the major components (compiler, kernel, and so on) of the operating system on which the executable runs, unless that component itself accompanies the executable.

If distribution of executable or object code is made by offering access to copy from a designated place, then offering equivalent access to copy the source code from the same place counts as distribution of the source code, even though third parties are not compelled to copy the source along with the object code.

4. You may not copy, modify, sublicense, or distribute the Program except as expressly provided under this License. Any attempt otherwise to copy, modify, sublicense or distribute the Program is void, and will automatically terminate your rights under this License. However, parties who have received copies, or rights, from you under this License will not have their licenses terminated so long as such parties remain in full compliance.
5. You are not required to accept this License, since you have not signed it. However, nothing else grants you permission to modify or distribute the Program or its derivative works. These actions are prohibited by law if you do not accept this License. Therefore, by modifying or distributing the Program (or any work based on the Program), you indicate your acceptance of this License to do so, and all its terms and conditions for copying, distributing or modifying the Program or works based on it.
6. Each time you redistribute the Program (or any work based on the Program), the recipient automatically receives a license from the original licensor to copy, distribute or modify the Program subject to these terms and conditions. You may not impose any further restrictions on the recipients' exercise of the rights granted herein. You are not responsible for enforcing compliance by third parties to this License.
7. If, as a consequence of a court judgment or allegation of patent infringement or for any other reason (not limited to patent issues), conditions are imposed on you (whether by court order, agreement or otherwise) that contradict the conditions of this License, they do not excuse you from the conditions of this License. If you cannot distribute so as to satisfy simultaneously your obligations under this License and any other pertinent obligations, then as a consequence you may not distribute the Program at all. For example, if a patent license would not permit royalty-free

redistribution of the Program by all those who receive copies directly or indirectly through you, then the only way you could satisfy both it and this License would be to refrain entirely from distribution of the Program.

If any portion of this section is held invalid or unenforceable under any particular circumstance, the balance of the section is intended to apply and the section as a whole is intended to apply in other circumstances.

It is not the purpose of this section to induce you to infringe any patents or other property right claims or to contest validity of any such claims; this section has the sole purpose of protecting the integrity of the free software distribution system, which is implemented by public license practices. Many people have made generous contributions to the wide range of software distributed through that system in reliance on consistent application of that system; it is up to the author/donor to decide if he or she is willing to distribute software through any other system and a licensee cannot impose that choice.

This section is intended to make thoroughly clear what is believed to be a consequence of the rest of this License.

8. If the distribution and/or use of the Program is restricted in certain countries either by patents or by copyrighted interfaces, the original copyright holder who places the Program under this License may add an explicit geographical distribution limitation excluding those countries, so that distribution is permitted only in or among countries not thus excluded. In such case, this License incorporates the limitation as if written in the body of this License.
9. The Free Software Foundation may publish revised and/or new versions of the General Public License from time to time. Such new versions will be similar in spirit to the present version, but may differ in detail to address new problems or concerns.
Each version is given a distinguishing version number. If the Program specifies a version number of this License which applies to it and "any later version", you have the option of following the terms and conditions either of that version or of any later version published by the Free Software Foundation. If the Program does not specify a version number of this License, you may choose any version ever published by the Free Software Foundation.
10. If you wish to incorporate parts of the Program into other free programs whose distribution conditions are different, write to the author to ask for permission. For software which is copyrighted by the Free Software Foundation, write to the Free Software Foundation; we sometimes make exceptions for this. Our decision will be guided by the two goals of preserving the free status of all derivatives of our free software and of promoting the sharing and reuse of software generally.

NO WARRANTY

11. BECAUSE THE PROGRAM IS LICENSED FREE OF CHARGE, THERE IS NO WARRANTY FOR THE PROGRAM, TO THE EXTENT PERMITTED BY APPLICABLE LAW. EXCEPT WHEN OTHERWISE STATED IN WRITING THE COPYRIGHT HOLDERS AND/OR OTHER PARTIES PROVIDE THE PROGRAM "AS IS" WITHOUT WARRANTY OF ANY KIND, EITHER EXPRESSED OR IMPLIED, INCLUDING, BUT NOT LIMITED TO, THE IMPLIED WARRANTIES OF MERCHANTABILITY AND FITNESS FOR A PARTICULAR PURPOSE. THE ENTIRE RISK AS TO THE QUALITY AND PERFORMANCE OF THE PROGRAM IS WITH YOU. SHOULD THE PROGRAM PROVE DEFECTIVE, YOU ASSUME THE COST OF ALL NECESSARY SERVICING, REPAIR OR CORRECTION.
12. IN NO EVENT UNLESS REQUIRED BY APPLICABLE LAW OR AGREED TO IN WRITING WILL ANY COPYRIGHT HOLDER, OR ANY OTHER PARTY WHO MAY MODIFY AND/OR REDISTRIBUTE THE PROGRAM AS PERMITTED ABOVE, BE LIABLE TO YOU FOR DAMAGES, INCLUDING ANY GENERAL, SPECIAL, INCIDENTAL OR CONSEQUENTIAL DAMAGES ARISING OUT OF THE USE OR INABILITY TO USE THE PROGRAM (INCLUDING BUT NOT LIMITED TO LOSS OF DATA OR DATA BEING RENDERED INACCURATE OR LOSSES SUSTAINED BY YOU OR THIRD PARTIES OR A FAILURE OF THE PROGRAM TO OPERATE WITH ANY OTHER PROGRAMS), EVEN IF SUCH HOLDER OR OTHER PARTY HAS BEEN ADVISED OF THE POSSIBILITY OF SUCH DAMAGES.

END OF TERMS AND CONDITIONS



For Technical Support:
www.avocent.com/support