



Liebert® GXT5 UPS

Installer/User Guide

120/208 V Input (L1, L2, N, G), 120/208 V Output (MV)

The information contained in this document is subject to change without notice and may not be suitable for all applications. While every precaution has been taken to ensure the accuracy and completeness of this document, Vertiv assumes no responsibility and disclaims all liability for damages result from use of this information or for any errors or omissions.

Refer to local regulations and building codes relating to the application, installation, and operation of this product. The consulting engineer, installer, and/or end user is responsible for compliance with all applicable laws and regulations relation to the application, installation, and operation of this product.

The products covered by this instruction manual are manufactured and/or sold by Vertiv. This document is the property of Vertiv and contains confidential and proprietary information owned by Vertiv. Any copying, use, or disclosure of it without the written permission of Vertiv is strictly prohibited.

Names of companies and products are trademarks or registered trademarks of the respective companies. Any questions regarding usage of trademark names should be directed to the original manufacturer.

Technical Support Site

If you encounter any installation or operational issues with your product, check the pertinent section of this manual to see if the issue can be resolved by following outlined procedures.

Visit <https://www.vertiv.com/en-us/support/> for additional assistance.

TABLE OF CONTENTS

1 Important Safety Instructions	1
2 Product Description	3
2.1 UPS Features and Available Models	3
2.2 Front Panels	3
2.3 Rear Panels	4
2.4 Removable Power Distribution Box	6
2.5 Internal Battery Packs	10
2.6 Major Internal Components and Operating Principle	10
2.7 UPS States and Operating Modes	11
2.7.1 Normal Mode	11
2.7.2 Bypass Mode	12
2.7.3 Battery Mode	13
2.7.4 Frequency Converter Mode	14
2.7.5 ECO Mode	15
3 Installation	17
3.1 Unpacking and Inspection	17
3.2 Pre-installation Preparation	17
3.2.1 Installation Clearances	17
3.3 Installing the UPS	17
3.3.1 Tower Installation	18
3.3.2 Rack Installation	18
3.4 Installing the Internal Battery Kits	18
3.5 Installing External Battery Cabinets	19
3.6 Installing the Power Output Distribution Box	21
3.6.1 Installing the Power Distribution Box on GXT5-5000MVRT4UXLN and GXT5- 6000MVRT4UXLN Models ..	21
3.6.2 Installing the Power Distribution Box on GXT5-8000MVRT6UXLN and GXT5- 10KMVRT6UXLN Models	22
3.7 Removing the Power Distribution Box from GXT5- 5000MVRT4UXLN and GXT5-6000MVRT4UXLN Models	22
3.8 Removing the Power Distribution Box from GXT5- 8000MVRT6UXLN and GXT5-10KMVRT6UXLN Models	23
3.9 Hardwired Input/Output Connections	24
3.9.1 Branch Circuit Breaker	25
3.9.2 Terminal Block Connections	26
3.10 Communication Connection	27
3.10.1 Connecting Liebert® IntelliSlot™ Communication	27
3.10.2 Connecting to the Dry Contact Port	27
3.10.3 Connecting a Remote Emergency Power Off (REPO) Switch	29
3.10.4 Connecting a USB Cable	30
3.10.5 Connecting CLI Communication Cables	30

- 4 Operating the UPS 33**
 - 4.1 Silencing the Audible Alarm 33
 - 4.2 Starting-up the UPS 33
 - 4.3 Transferring to Battery Mode 33
 - 4.4 Transferring from Normal to Bypass Mode 34
 - 4.5 Transferring from Bypass to Normal Mode 34
 - 4.6 Shutting Down the UPS Completely 34
 - 4.7 Remote Emergency Power Off (REPO) 34
- 5 Operation and Display Panel 35**
 - 5.1 LED Indicators 36
 - 5.2 LCD Menu and Screens 36
 - 5.2.1 Start-up and Flow Screens 36
 - 5.2.2 Main Menu 37
 - 5.2.3 Status Screen 38
 - 5.2.4 Settings Submenu 41
 - 5.2.5 Control Screen 47
 - 5.2.6 Log Screen 48
 - 5.2.7 About Screen 52
 - 5.3 Editing Display and Operation Settings 54
 - 5.3.1 Setting Prompts 54
 - 5.3.2 Changing the Password 55
 - 5.3.3 Selecting the Display Language 56
 - 5.3.4 Setting the Date and Time 56
- 6 Maintenance 57**
 - 6.1 Replacing Batteries 57
 - 6.2 Charging Batteries 59
 - 6.3 Checking UPS Operation 59
 - 6.4 Cleaning the UPS 59
 - 6.5 Replacing the UPS using Maintenance Bypass 60
 - 6.6 Firmware Updates 61
- 7 Troubleshooting 63**
 - 7.1 Symptoms that Require Troubleshooting 63
 - 7.2 Audible Alarm (Buzzer) 63
 - 7.2.1 Faults 63
 - 7.3 Troubleshooting UPS Issues 64
- 8 Specification 65**
 - 8.1 Battery Run Times 69
- Appendices 73**
 - Appendix A: Technical Support and Contacts 73
 - Appendix B: Open Source Software Legal Notices 75

1 Important Safety Instructions

IMPORTANT! This manual contains important safety instructions that must be followed during the installation and maintenance of the UPS and batteries. Read this manual thoroughly and the safety and regulatory information, available at <https://www.vertiv.com/ComplianceRegulatoryInfo>, before attempting to install, connect to supply, or operate this UPS.

Comply with all warnings and operating instructions in this manual strictly. Save this manual and carefully read the following instructions before installing the unit. Do not operate this unit before reading all safety information and operating instructions carefully.

Transportation

Only transport the UPS system in the original packaging to protect against shock and impact.

Preparation

- Condensation may occur if the UPS system is moved directly from a cold to a warm environment. The UPS system must be absolutely dry before being installed. Please allow at least two hours for the UPS system to acclimate the environment.
- Do not install the UPS system near water or in moist environments.
- Do not install the UPS system where it would be exposed to direct sunlight or near a heater.
- Do not block ventilation holes in the UPS housing.

Installation

- Do not connect appliances or devices which would overload the UPS system (e.g. laser printers) to the UPS output sockets.
- Place cables in such a way that no one can step on or trip over them.
- Do not connect domestic appliances such as hair dryers to UPS output sockets.
- Connect the UPS system only to an earthed shockproof outlet which must be easily accessible and close to the UPS system.
- Please use only VDE-tested, CE-marked mains cable (e.g. the mains cable of your computer) to connect the UPS system to the building wiring shockproof outlet.
- Please use only VDE-tested, CE-marked power cables to connect the loads to the UPS system.
- When installing the equipment, ensure that the sum of the leakage current of the UPS and the connected devices does not exceed 3.5 mA.

Operation

- Do not disconnect the mains cable on the UPS system or the building wiring shockproof outlet during operations since this would cancel the protective earthing of the UPS system and of all connected loads.
- The UPS system features its own, internal power source (batteries). The UPS output sockets or output terminal blocks may be electrically live even if the UPS system is not connected to the building wiring outlet.
- In order to fully disconnect the UPS system, first press the OFF/Enter button to disconnect the mains.
- Prevent fluids and foreign objects from entering the inside of the UPS system.

Maintenance, Service, and Faults

- The UPS system operates with hazardous voltages. Repairs may be carried out only by qualified maintenance personnel.



WARNING! Risk of electric shock. Even after the unit is disconnected from the mains (building wiring outlet), components inside the UPS system are still connected to the battery and electrically live and dangerous.

- Before carrying out any kind of service and/or maintenance, disconnect the batteries and verify that no current is present and no hazardous voltage exists in the terminals of high energy capacitors such as Bus capacitors.
- Only persons that are adequately familiar with batteries and with the required precautionary measures may replace batteries and supervise operations. Unauthorized persons must be kept well away from the batteries.



WARNING! Risk of electric shock. The battery circuit is not isolated from the input voltage. Hazardous voltages may occur between the battery terminals and the ground. Before touching, please verify that no voltage is present!

- Batteries may cause electric shock and have a high short circuit current. Please take the precautionary measures specified below and any other measures necessary when working with batteries:
 - Remove wristwatches, rings, and other metal objects.
 - Use only tools with insulated grips and handles.
- When changing batteries, install the same number and same type of batteries.
- Do not attempt to dispose of batteries by burning them. This could cause battery explosion.
- Recycle or dispose of batteries properly according to local regulations.
- Do not open or destroy batteries. Escaping electrolyte can cause injury to the skin and eyes. It may be toxic.
- Please replace fuses only with the same type and amperage in order to avoid fire hazards.
- Do not dismantle the UPS system.

2 Product Description

The Vertiv™ Liebert® GXT5 is a compact, online uninterruptible power system (UPS) that continuously conditions and regulates its output voltage. The Liebert® GXT5 supplies computers and other sensitive equipment with clean sine-wave input power.

Upon generation, AC power is clean and stable. However, during transmission and distribution it is subject to voltage sags, spikes, and complete failure that may interrupt computer operations, cause data loss, and damage equipment.

The Liebert® GXT5 protects equipment from these disturbances. The Liebert® GXT5 continuously charges its batteries from the mains, enabling it to supply power to connected loads, even when the mains fail.

2.1 UPS Features and Available Models

The Liebert® GXT5 includes the following features. **Table 2.1** below, lists the available models and power ratings.

- Enhanced load capacity with an output power factor of 1.
- Input power factor greater than 0.99.
- Optional tower or rack installation to meet varying installation requirements.
- Adapts to areas with unstable power mains supply via high frequency double conversion topology structure, with high input power factor, wide input voltage range, and output immune to grid interference.
- Operation and Display panel with model specific color LCD offers simple configuration and control of the UPS.
- ECO mode and smart sleep mode help you save the maximum amount of energy.

Table 2.1 UPS Models and Power Ratings

Model Number	Nominal Power Rating at 120/208 V
GXT5-5000MVRT4UXLN	5000 VA/5000 W
GXT5-6000MVRT4UXLN	6000 VA/6000 W
GXT5-8000MVRT6UXLN	8000 VA/8000 W
GXT5-10KMVRT6UXLN	10000 VA/10000 W
GXT5-15KMVRT11UXLN	15000 VA/15000 W
GXT5-20KMVRT11UXLN	20000 VA/20000 W

2.2 Front Panels

The various Liebert® GXT5 models have the same general appearance, with the main difference being the receptacle types on the rear panel.

Figure 2.1 Front View

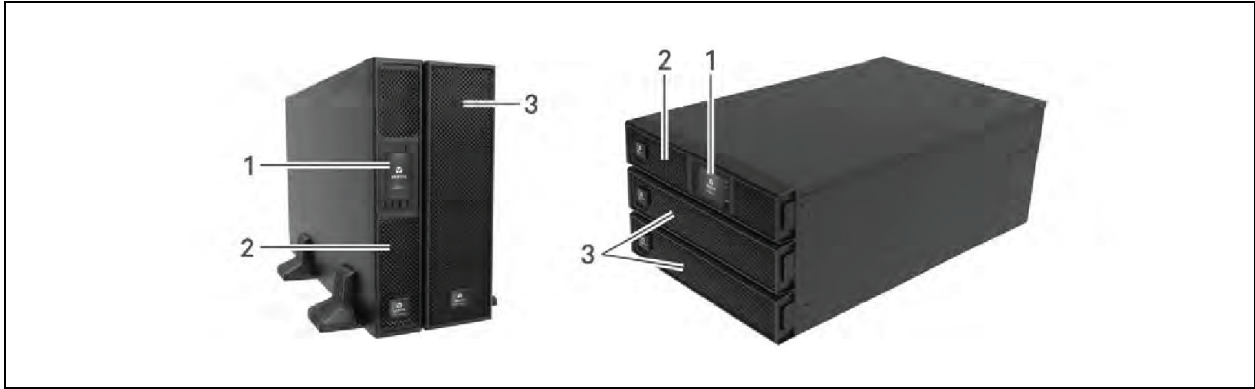

Item	Description
1	Operation/Display panel
2	Upper bezel
3	Lower bezel/battery access door

2.3 Rear Panels

The following figures detail the rear panel features for each Liebert® GXT5 model.

Figure 2.2 GXT5-5000/6000MVRT4UXLN Rear Panel

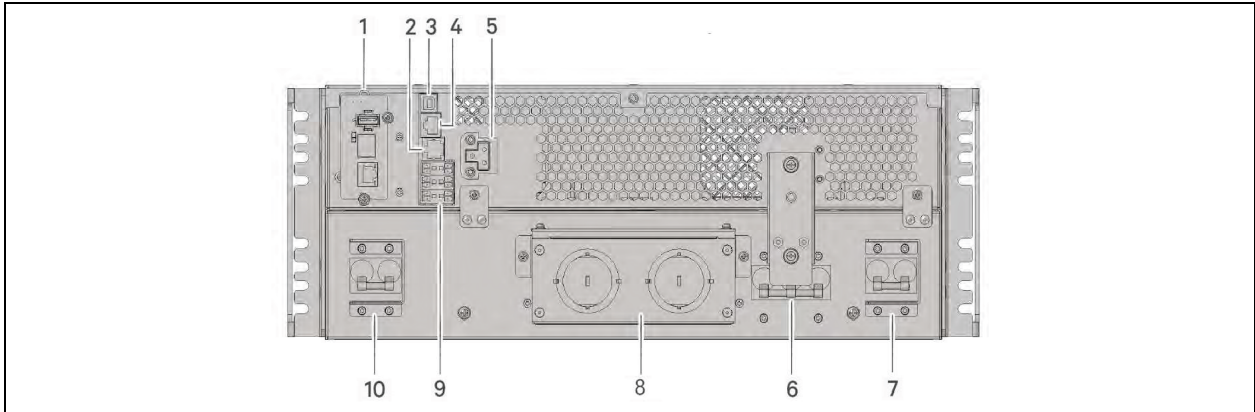

Item	Description
1	Vertiv™ Liebert® IntelliSlot™ port
2	RS-232 port, RJ-45/RJ-11 connection—Used for CLI
3	USB port
4	RS-485 port, RJ-45 connection—Used for external temperature sensors
5	External battery cabinet (EBC) connector

Item	Description
6	Maintenance bypass breaker (MBB)
7	Input breaker
8	Knockouts for hard wired input and output
9	Terminal block communication connectors
10	Output breaker

Figure 2.3 GXT5-8000/10KMVRT6UXLN Rear Panel

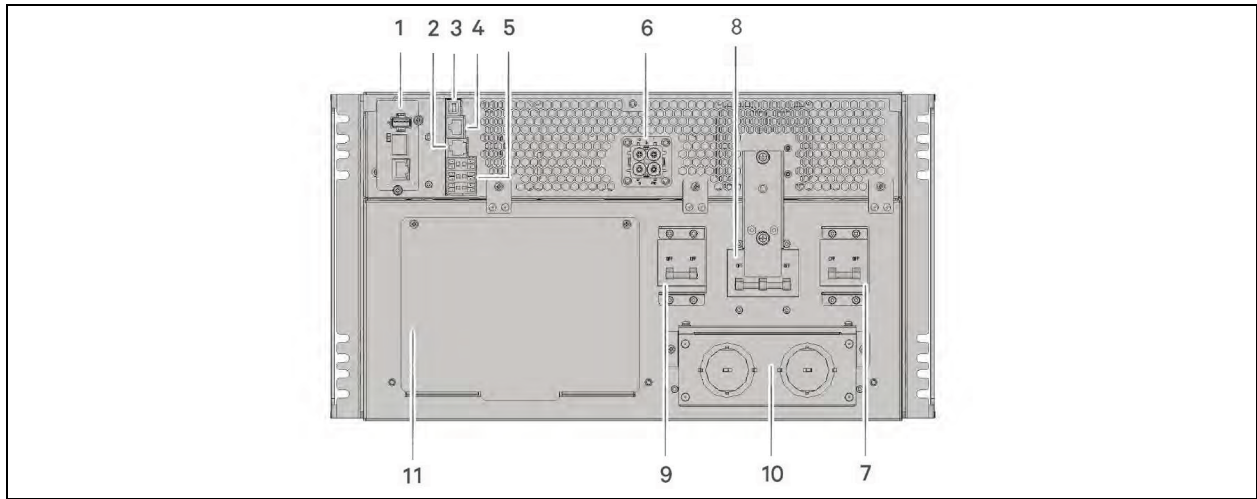

Item	Description
1	Vertiv™ Liebert® IntelliSlot™ port
2	RS-232 port, RJ-45/RJ-11 connection — Used for CLI
3	USB port
4	RS-485 port, RJ-45 connection — Used for external temperature sensors
5	Terminal-block communication connectors
6	EBC connector
7	Output breaker
8	Maintenance bypass breaker
9	Input breaker
10	Knockouts for hard wired input and output
11	Cover for power distribution box connector

Figure 2.4 GXT5 15/20KMVRT11UXLN Rear Panel

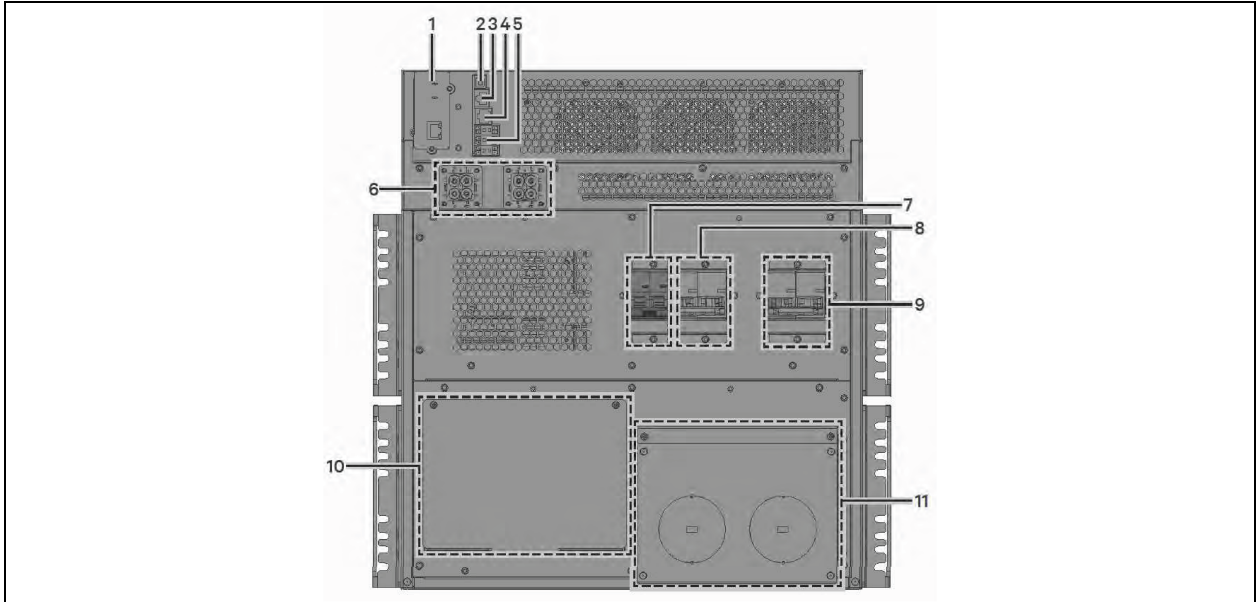

Item	Description
1	Vertiv™ Liebert® IntelliSlot™ port
2	USB port
3	RS-485 port — Used for external temperature sensors
4	RS-232 port — Used for CLI
5	Dry contacts, Battery detection (3), REPO input (REPO)
6	EBC connector
7	POD breaker
8	Output breaker
9	Input breaker
10	Cover for power distribution box connector
11	Knockouts for hard wired input and output

2.4 Removable Power Distribution Box

The 5 kVA and 6 kVA models ship with the PD5-UL6HDWR-MBS installed. This power output distribution box (POD) includes the input circuit breaker for the UPS, and the POD options are shown in **Figure 2.5** on the facing page.

The 8 kVA and 10 kVA models ship with the standard POD installed. The POD options are shown in **Figure 2.6** on page 8, and **Figure 2.7** on page 9.

NOTE: Output power capacity after derating with POD can be found under the About menu at the Efficiency tab.

NOTE: In **Figure 2.5** on the facing page, the components on PD5-001 are labeled. The features may be arranged differently on other PODs.

Figure 2.5 Power Output Distribution Options for GXT5 5000/6000MVRT4UXLN

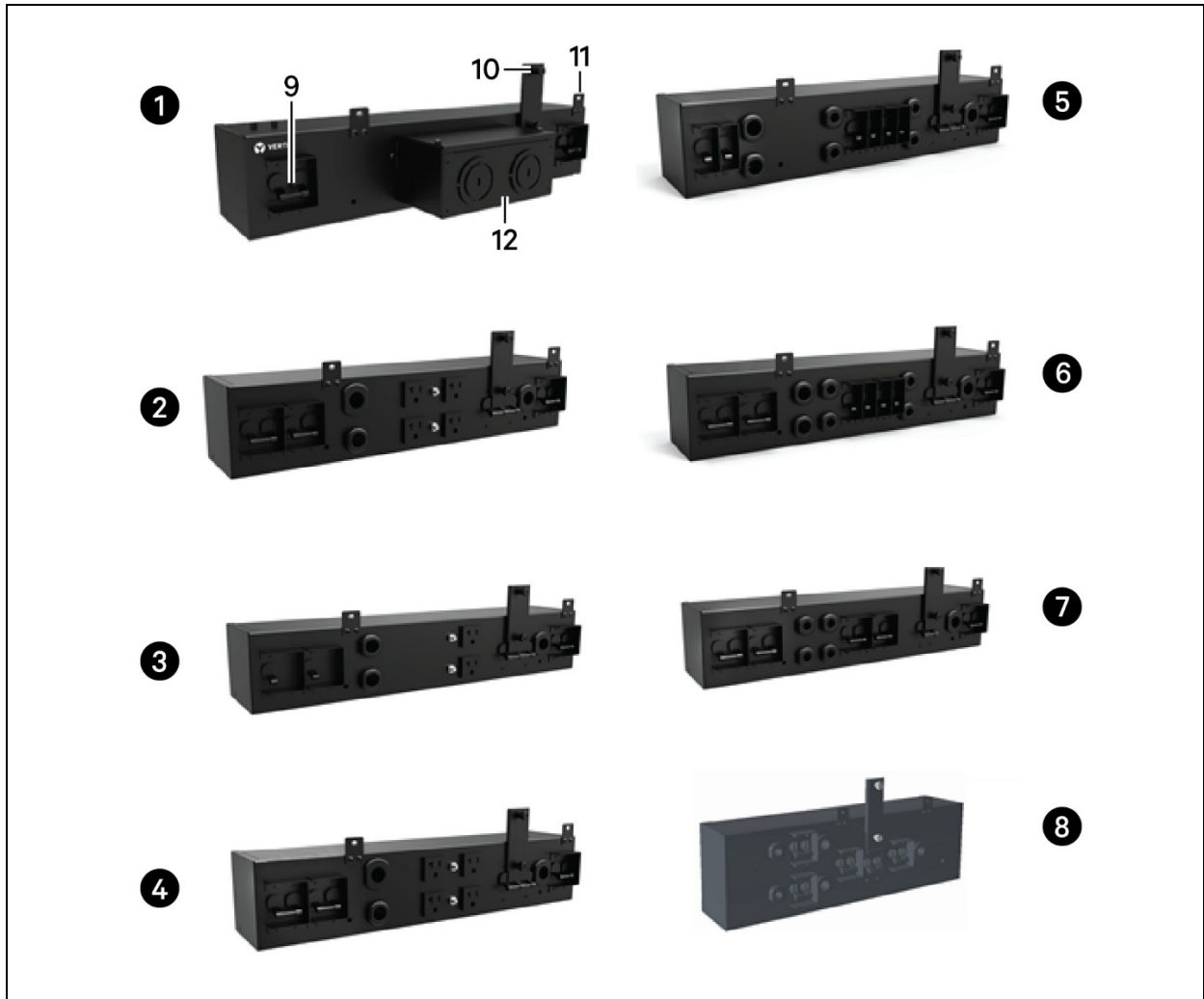

Item	Part Number	Input Connections	Description
1	PD5-UL6HDWR-MBS	Hardwire	Hardwire
2	PD5-001	L14-30P	1x L14-30R, 1x L6-30R, 4x 5-15/20 T slot
3	PD5-002	L14-30P	2x L6-20R, 2x 5-15/20R T slot
4	PD5-003	L14-30P	2x L6-30R, 4x 5-15/20R T slot
5	PD5-004	L14-30P	4x L5-20R, 2x L5-30R
6	PD5-005	L14-30P	4x L5-20R, 2x L6-30R
7	PD5-006	L14-30P	4x L6-20R

NOTE: In Figure 2.6 on the next page, the components on PD2-101 are labeled. The features are arranged differently on other PODs.

Figure 2.6 Several Power output Distribution Options for GXT5-8000/10KMVRT6UXLN

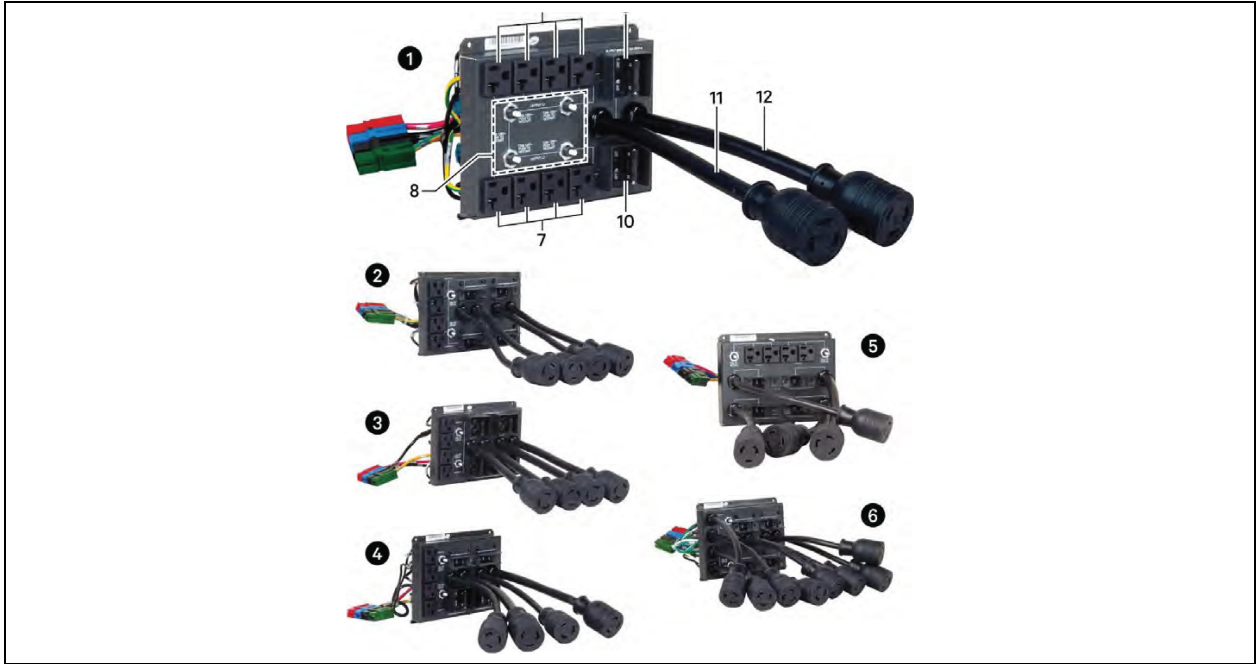

Item	Part Number	Output Connections
1	PD2-101	2x L6-30R, 8x 5-15/20R T slot
2	PD2-102	4x L6-20R, 4x 5-15/20R T slot
3	PD2-103	4x L6-30R, 4x 5-15/20R T slot
4	PD2-104	4x 5-15/20R T slot, 2x L6-30R, 2x L6-20R
5	PD2-105	4x 5-15/20R T slot, 2x L5-30R, 2x L5-20R
6	PD2-106	4x L6-20R, 4x L5-20R

Figure 2.7 Additional Power Output Distribution Options for GXT5-8000/10KMVRT6UXLN and GXT5-15K/20KMVR-T11UXLN

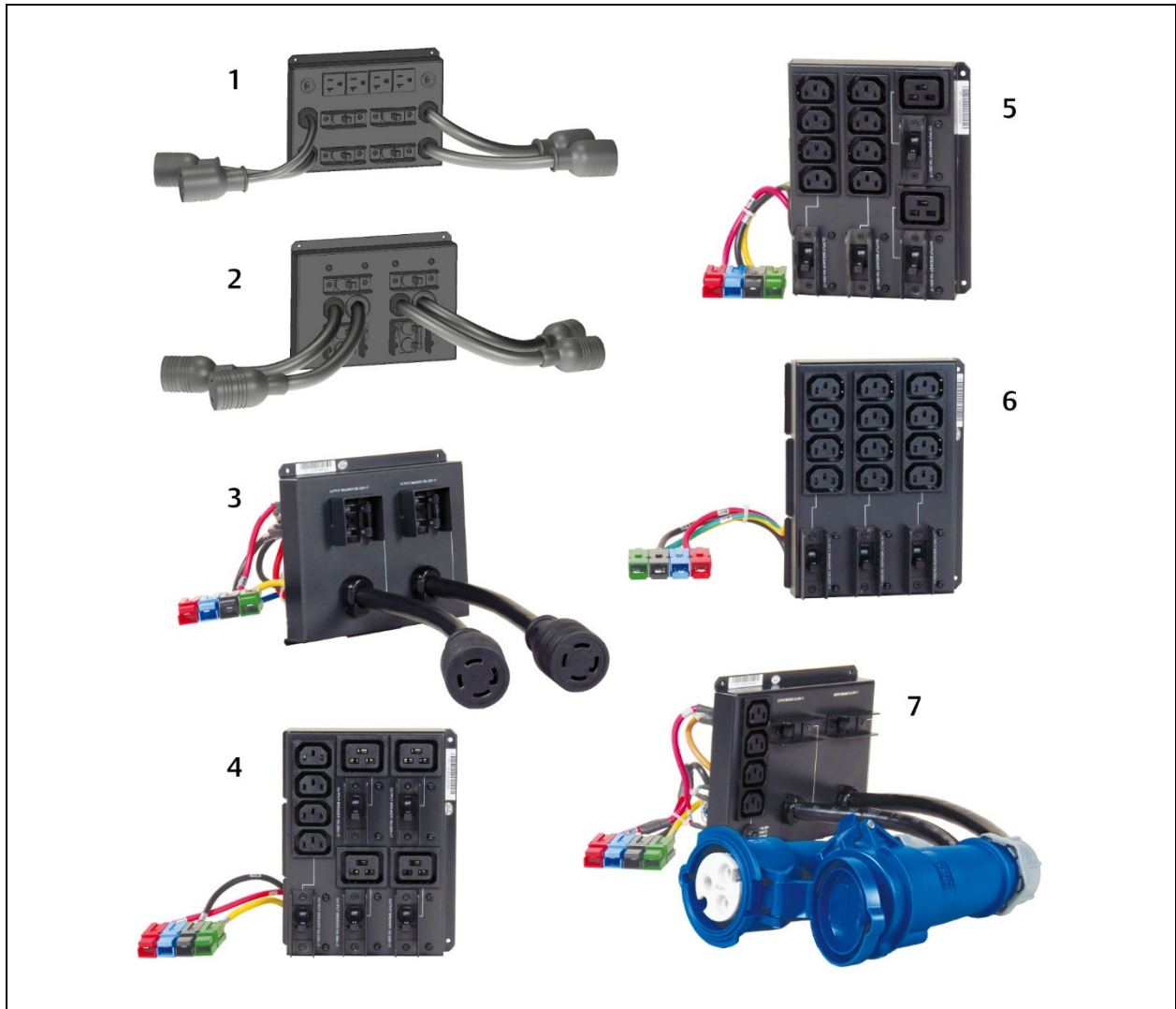

Item	Part Number	Output Connections
1	PD2-107	4x L5-20R, 4x 5-15/20R T slot
2	PD2-108	2x L6-30R, 2x L6-20R
3	PD2-109	2x L14-30R
4	PD2-200	4x IEC320-C19, 4x IEC320-C13
5	PD2-201	2x IEC320-C19, 8x IEC320-C13
6	PD2-202	12x IEC320-C13
7	PD2-204	2x IEC309-32A, 4x IEC320-C13

2.5 Internal Battery Packs

The internal battery packs for all Vertiv™ Liebert® GXT5 MV models, shown in **Figure 2.8** below, are located behind the access door on the front of the UPS. 5 kVA and 6 kVA units have 1 battery pack, and 8 kVA and 10 kVA units have 2 battery packs and 15 kVA and 20 kVA units have 4 battery packs.

Figure 2.8 Internal Battery Pack



Item	Description
1	Handle
2	Connector

2.6 Major Internal Components and Operating Principle

Figure 2.9 below, shows the UPS operating principle. **Table 2.2** on the facing page, describes the function of the major components in the UPS.

NOTE: **Figure 2.9** below, is one example of basic operation.

Figure 2.9 Basic Operating Principle Diagram

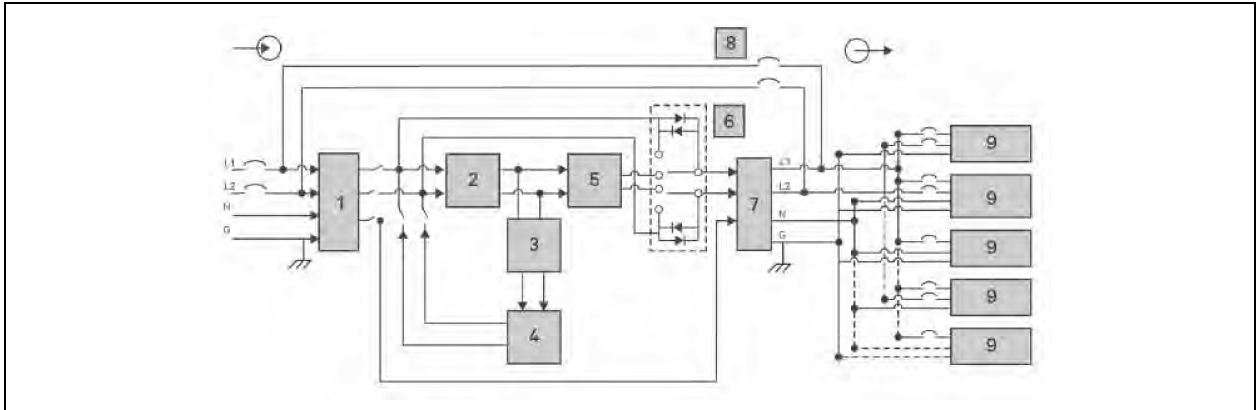

Table 2.2 Major Components

Item	Component	Operation/Function
1	Transient Voltage Surge Suppression (TVSS) and EMI/RFI Filters	Provide surge protection. Filter electromagnetic interference (EMI) and radio frequency interference (RFI). Minimize surges or interference present in the utility power and protect devices connected on the same branch as the UPS.
2	Rectifier/Power factor Correction (PFC) Circuit	In normal operation, converts utility AC power to regulate DC power for use by the inverter while ensuring that the wave shape of the input current used by the UPS is near ideal. Extracting this sine-wave input current ensures efficient use of utility power and reduces reflected harmonic distortion making cleaner power available to devices that are not protected by the UPS. The DC-to-DC converter raises the DC voltage from the battery to the optimum operating voltage for the inverter. This allows the inverter to operate continuously at its optimum efficiency and voltage, thus increasing reliability.
3	Battery Charger	Regulates input AC power to continuously float charge the batteries. Batteries are charged when the UPS is plugged in, even when not powered on.
4	Batteries	Valve-regulated, non-spillable, lead-acid batteries. NOTE: To maintain battery design life., operate the UPS in an ambient temperature of 59 °F to 77 °F (15 °C to 25 °C).
5	Inverter	In normal operation, inverts the DC output of the PFC circuit into precise, regulated sine-wave AC power. When utility power fails, the inverter receives DC power from the DC-to-DC converter. In either operating mode, the UPS inverter remains on-line, generating clean, precise, regulated AC-output power.
6	Dynamic Internal Bypass	In the unlikely event of UPS failure such as overload or over-temperature, automatically transfers the connected load to bypass. To manually transfer the connected load from inverter to bypass, see Transferring from Normal to Bypass Mode on page 34.
7	EMI/RFI Filters	Filter electromagnetic interference (EMI) and radio frequency interference (RFI). Minimize interference present in the utility power and protect devices connected on the same branch as the UPS.
8	Maintenance Bypass	In the unlikely event of UPS failure, allows replacing the UPS while keeping the connected equipment powered with utility power. NOTE: The bypass power path does not protect connected equipment from disturbances in the utility supply. 15 kVA and 20 kVA units do not have internal maintenance bypass.
9	Outlet group	General output receptacles.

2.7 UPS States and Operating Modes

NOTE: See [LED Indicators](#) on page 36, for description of the run-indicator and alarm-indicator LEDs mentioned in this section.

2.7.1 Normal Mode

When utility power is normal, normal mode employs the rectifier and inverter to provide voltage and frequency stabilized power to the load. The charger charges the battery in normal mode. On the front panel display, the run-indicator (green) is ON, the alarm indicator is OFF, and the buzzer is silent. **Figure 2.10** on the next page shows the diagram of normal mode.

Figure 2.10 Normal Mode Operation

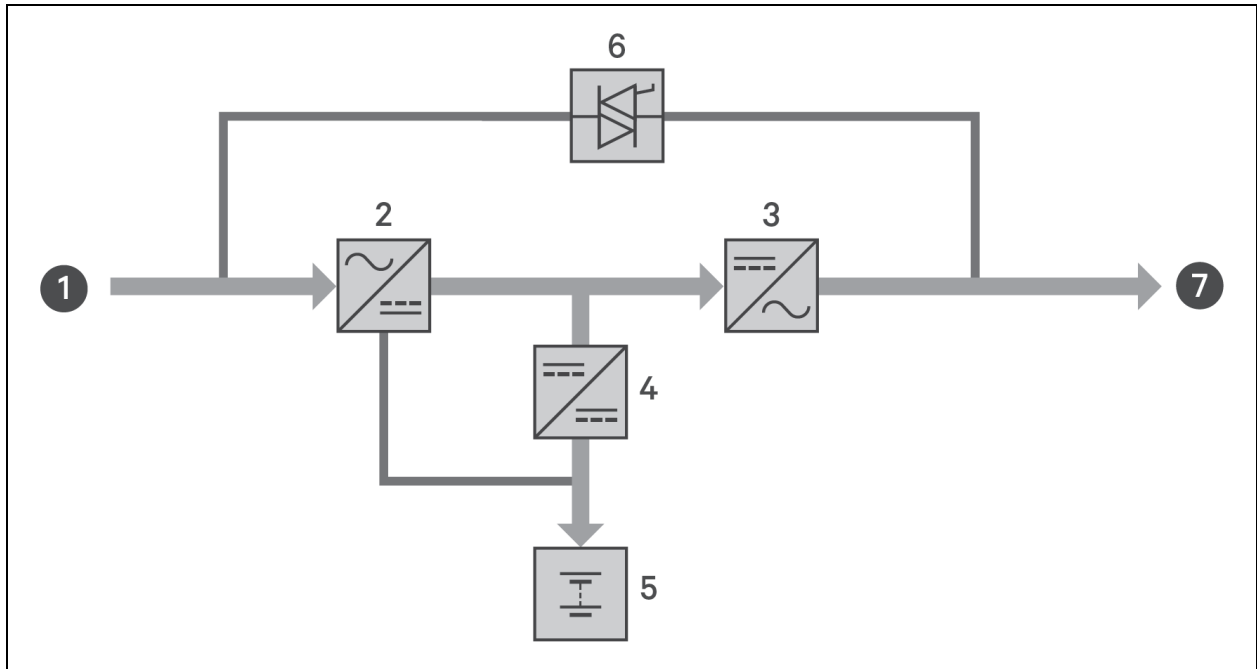

Item	Description
1	Mains/Utility input (bypass input)
2	Rectifier/PFC
3	Inverter
4	Battery charger
5	Battery
6	Bypass static switch
7	UPS output

2.7.2 Bypass Mode

Bypass mode supplies power to the load from the bypass source (utility power) if an overload or fault occurs during normal operation. On the front panel display, the run indicator (green) is ON, the alarm indicator (yellow) is ON, and the buzzer beeps once every two seconds. The LCD *current* screen displays *On Bypass*. **Figure 2.11** on the facing pages shows the diagram of bypass mode.

NOTE: If utility power fails or if the utility voltage goes outside of the permissible range during bypass mode operation, the UPS shuts down and no output is supplied to the load.

Figure 2.11 Bypass Mode Operation

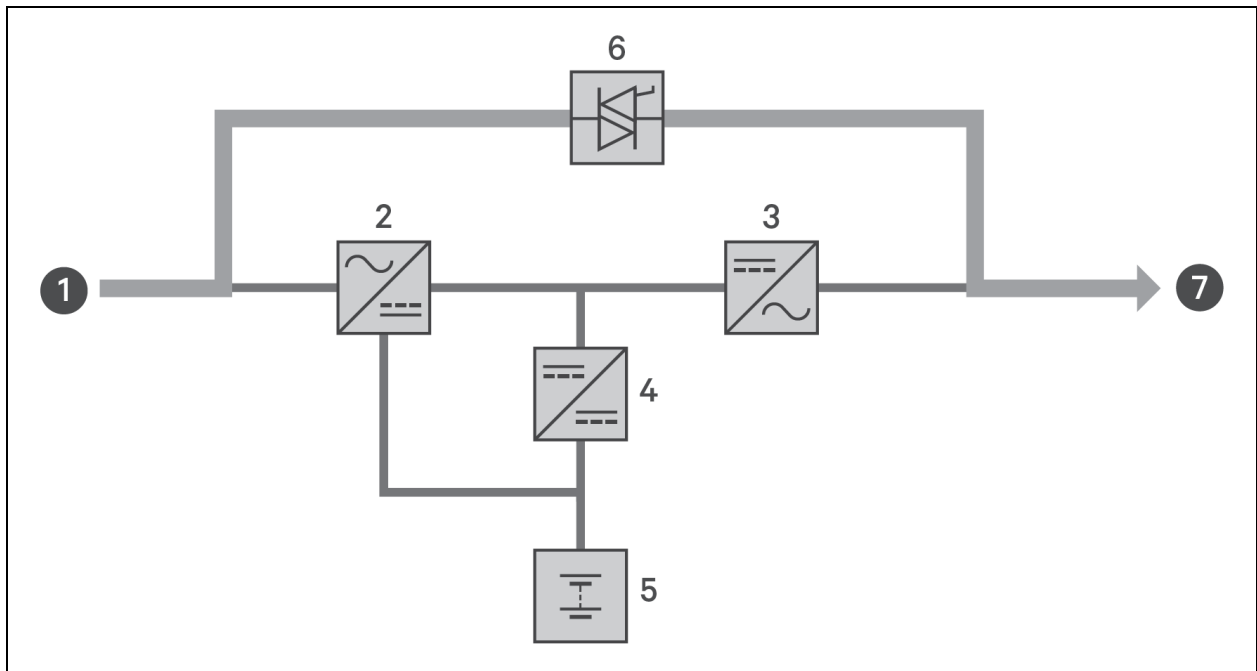

Item	Description
1	Mains/Utility input (bypass input)
2	Rectifier/PFC
3	Inverter
4	Battery charger
5	Battery
6	Bypass static switch
7	UPS output

2.7.3 Battery Mode

Battery mode supplies battery power to the load if utility power fails or if the utility voltage goes outside of the permissible range. On the front panel display, the run indicator (green) is ON, the alarm indicator (yellow) is ON, and the buzzer beeps every two seconds. The LCD Flow screen displays On Battery. **Figure 2.12** on the next page shows the diagram of battery mode.

Figure 2.12 Battery Mode Operation

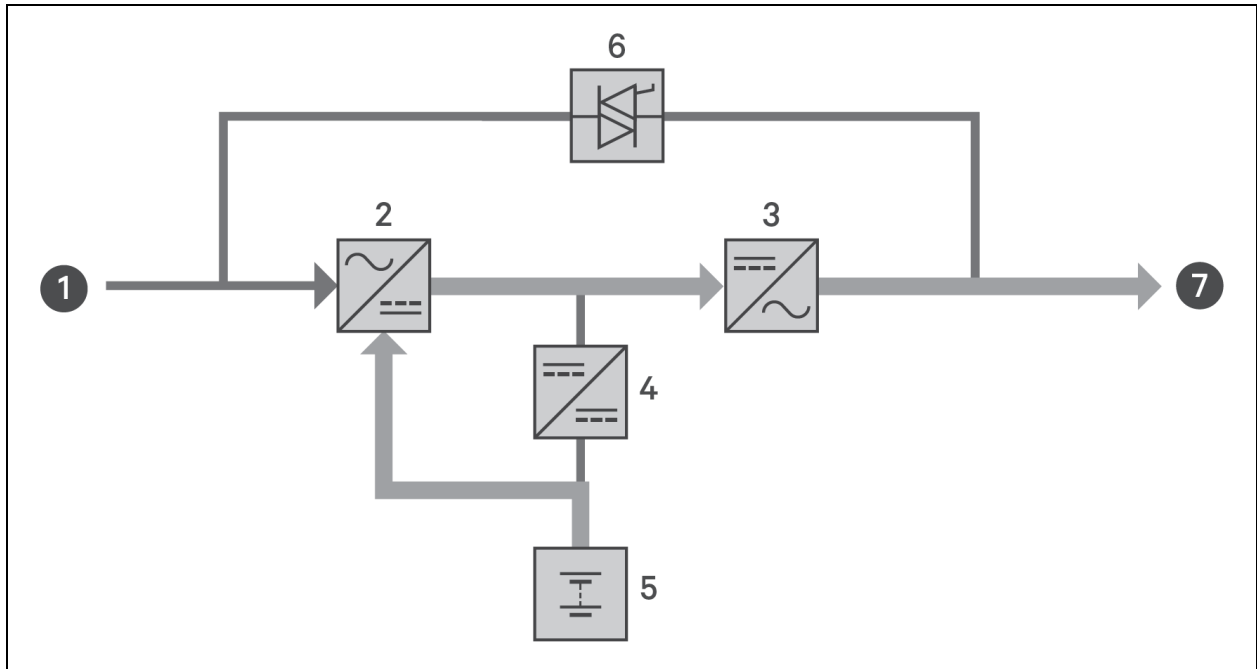

Item	Description
1	Mains/Utility input (bypass input)
2	Rectifier/PFC
3	Inverter
4	Battery charger
5	Battery
6	Bypass static switch
7	UPS output

NOTE: The batteries are fully charged before shipment. However, transportation and storage inevitably cause some loss of capacity. To ensure adequate back-up time, it is recommended to charge the batteries for at least 8 hours before first start-up.

NOTE: If utility power fails and the batteries are charged, you may cold-start the UPS in battery mode and use battery power to extend system availability for a time.

NOTE: Powering off the UPS when it is in battery mode results in loss of output power to the connected load.

2.7.4 Frequency Converter Mode

All models of the Vertiv™ Liebert® GXT5 are capable of frequency conversion. Frequency Conversion Mode can be selected using the configuration program. Allowable frequency operating mode include:

- Auto Sensing - 50 Hz or 60 Hz – Bypass Enabled
- Auto Sensing - 50 Hz or 60 Hz – Bypass Disabled
- Frequency Converter - 50 Hz – Bypass Disabled

- Frequency Converter - 60 Hz – Bypass Disabled

NOTE: The default for all model of the Liebert® GXT5 is Auto Sensing - 50 Hz or 60 Hz - Bypass Enabled.

2.7.5 ECO Mode

The energy saving ECO mode reduces power consumption by powering the load via bypass if the bypass voltage is normal or by powering the load via the inverter when the bypass voltage is abnormal. You can use ECO mode to power equipment that is not sensitive to power grid quality via bypass and reduce power consumption.

NOTE: During ECO mode, if a bypass failure or abnormal bypass voltage notification appears when the output is not overloaded, the UPS will transfer to Normal Mode. However, if a notification showing bypass failure or abnormal bypass voltage appears when the output is overloaded, the UPS will shut down the bypass and therefore the load will shut down.

This page intentionally left blank

3 Installation

Do not start the UPS until after the installation is finished.



WARNING! Risk of electric shock. Can cause equipment damage, injury and death. Before beginning installation, verify that all external overcurrent protection devices are open (Off), and that they are locked-out and tagged appropriately to prevent activation during the installation, verify with a voltmeter that power is Off and wear appropriate, OSHA approved personal protective equipment (PPE) per NFPA 70E. Failure to comply can cause serious injury or death. Before proceeding with installation, read all instructions. Follow all local codes.

3.1 Unpacking and Inspection

Unpack the UPS and conduct the following checks:

- Inspect the UPS for shipping damage. If any shipping damage is found, report it to the carrier and your local Vertiv representative immediately.
- Check the accessories included against the packing list. If there is any discrepancy, contact your local Vertiv representative immediately.



CAUTION: The UPS is heavy (see [Specification](#) on page 65, for the weight). Take proper precautions when lifting or moving the unit.

3.2 Pre-installation Preparation

- Install the UPS indoors in a controlled environment, where it cannot be accidentally turned Off. The installation environment should meet the specifications listed in [Specification](#) on page 65.
- Place the UPS in an area of unrestricted air-flow around the unit, away from water, flammable liquids, gases, corrosives, and conductive contaminants. Avoid direct sunlight.

NOTE: Operating the UPS in temperatures above 77°F (25°C) reduces battery life.

3.2.1 Installation Clearances

Maintain at least 4 in. (100 mm) clearance in the front and rear of the UPS. Do not obstruct the air inlets on the front panel and rear panel of the UPS. Blocking the air inlets reduces ventilation and heat dissipation, shortening the service life of the unit.

3.3 Installing the UPS

The UPS may be installed as a tower or in a rack, depending on available space and use considerations. Determine the type of installation and follow the appropriate instructions. See [Tower Installation](#) on the next page or [Rack Installation](#) on the next page.

After installing the UPS as a tower or in a rack, and before attempting to start-up, you must install the internal batteries. See [Installing the Internal Battery Kits](#) on the next page.

NOTE: When installing the UPS or making input and output connections, comply with all relevant safety codes and standards.

3.3.1 Tower Installation

To install the UPS as a tower:

1. Take the support bases out of the accessories box.

Figure 3.1 Support Bases

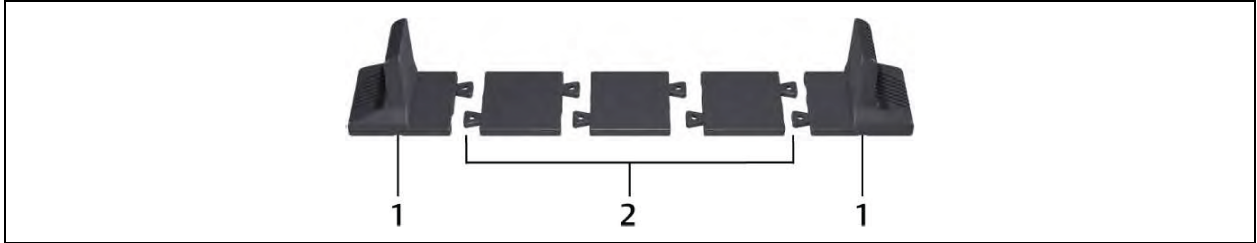

Item	Description
1	Support bases
2	Spacers with connectors

2. If optional external battery cabinets will be connected, take out the spacers shipped with the battery cabinet.
3. Connect the spacers and the support bases as shown in **Figure 3.1** above. Each Vertiv™ Liebert® GXT5 requires 2 support bases, one in the front and one in the rear.
4. Place the Liebert® GXT5 and any battery cabinets on the 2 support bases.
5. See [Installing the Internal Battery Kits](#) below, to install the battery packs.

3.3.2 Rack Installation

When installed in a rack enclosure, the Liebert® GXT5 UPS and external battery cabinets (EBC) must be supported by a shelf or rack-mount rails. Because different rack-mount options install differently, refer to the installation instructions provided with the rack-mount kit.



CAUTION: The Liebert® GXT5 is heavy. The UPS must be installed as near the bottom of a rack as possible. If placed too high, it can make the rack top-heavy and prone to tipping over. For unit weights, see [Specification](#) on page 65.

3.4 Installing the Internal Battery Kits

The internal battery kits are packed separately in boxes and are shipped in main box with the Liebert® GXT5, which is also in its own box.

1. Loosen and remove the screws on the battery door, see **Figure 3.2** on the facing page.
2. Lay the battery door and screws aside for reassembly.
3. Unpack the battery pack.

4. Line up and slowly slide the battery pack in until two-thirds of the length is inserted, then pull up slightly and continue pushing in firmly until the battery pack is fully inserted.
5. Attach the battery door with the screws. The battery door will cover the batteries if the packs are properly installed.
6. Attach the front cover to the UPS.

Figure 3.2 Support Bases

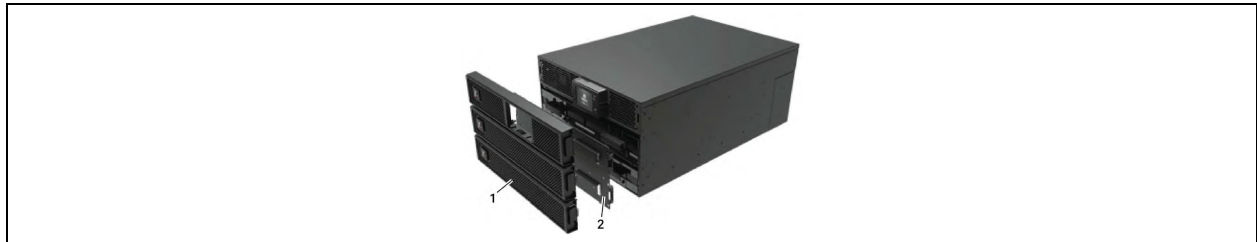

Item	Description
1	Front Panel
2	Battery Door

3.5 Installing External Battery Cabinets

Optional, external battery cabinets (EBC) may be connected in parallel to the UPS to provide additional battery run time. For approximate battery run times with additional EBCs, see [Battery Run Times](#) on page 69.

External battery cabinets are placed on one side of the UPS in a tower configuration or stacked beneath the UPS in a rack configuration. Up to 10 EBCs may be connected to the UPS, and up to 6 may be detected using EBC auto-detection.

For applications where the number of EBCs exceeds 6 or for legacy applications where EBC auto-detection is not possible, please contact Vertiv service for assistance.



WARNING! Risk of electric shock. Can cause injury or death. Disconnect all local and remote electric power supplies before working with the UPS. Ensure that the unit is shut down and power has been disconnected before beginning any maintenance.



CAUTION: The external battery cabinets are heavy, see [Table 8.5](#) on page 69. Take proper precautions when lifting them.

To install the EBCs:

1. Inspect the EBC for freight damage. Report damage to the carrier and your local dealer or Vertiv representative.
2. For tower installation:
 - An additional set of support-base extensions ships with each EBC.
 - See the steps in [Tower Installation](#) on the previous page, to connect the support extenders and install the bases

- or -
3. For rack installation:

- Rack-mount hardware ships with the EBC.
- Refer to the instructions included with the rack-mount kit to install.

NOTE: Optional slide rails and securing hardware are sold separately. Please contact your Vertiv representative for options and Vertiv Technical Support for assistance.

4. Verify that the EBC breaker is in the *Off* position.
5. Connect the supplied EBC cables to the rear of the cabinet, then to the rear of the UPS, see **Figure 3.3** below.
6. Turn the EBC breaker to the *On* position.
7. Verify the circuit breaker on the EBC is in the *On* position. The additional back-up run time is enabled.

NOTE: When removing an EBC, turn off the circuit breaker on the rear of the cabinet before disconnecting the cable.

NOTE: If shipping or storing the UPS for an extended time, disconnect the EBCs minimize stand-by current drain on the batteries and help maintain design life.

Figure 3.3 EBC Connection for 5-10K Models

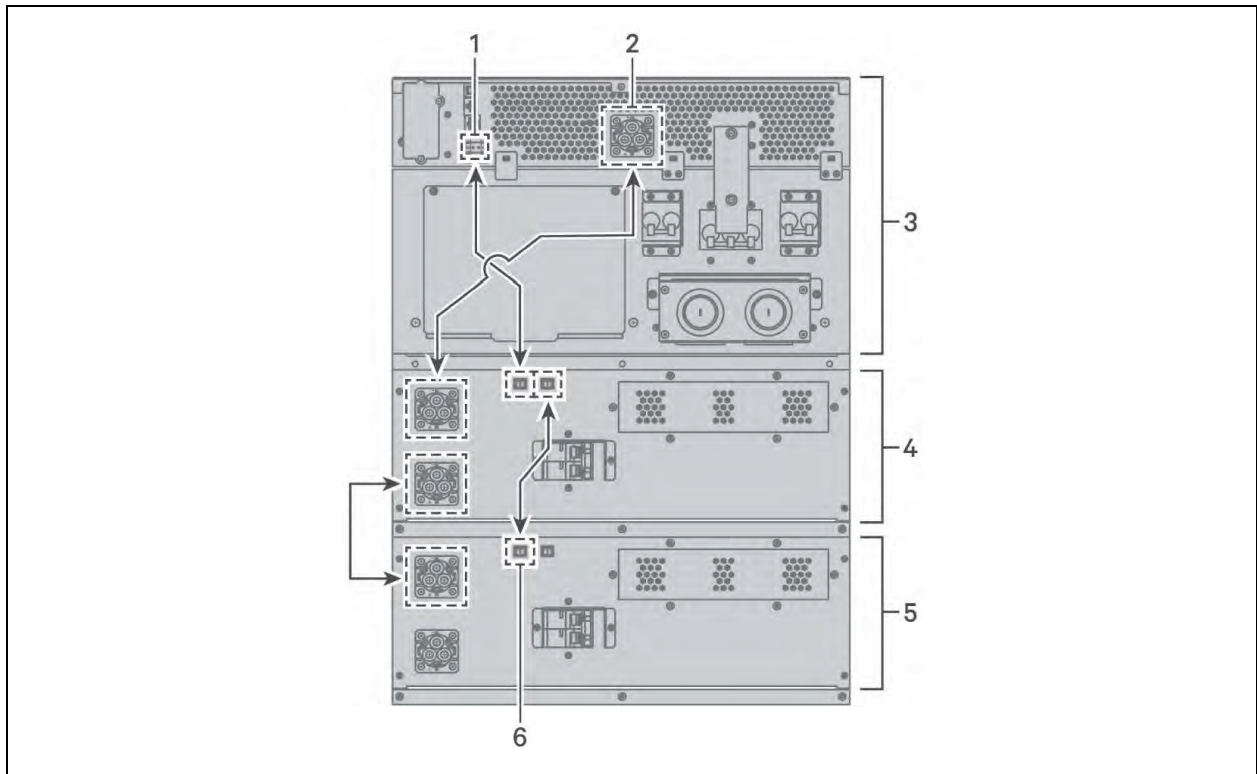

Item	Description
1	EBC-detection port (See Table 3.2 on page 26, for details)
2	EBC connector
3	UPS
4	External battery cabinet
5	External battery cabinet
6	EBC-detection port

Figure 3.4 EBC Connection for 15-20k Models

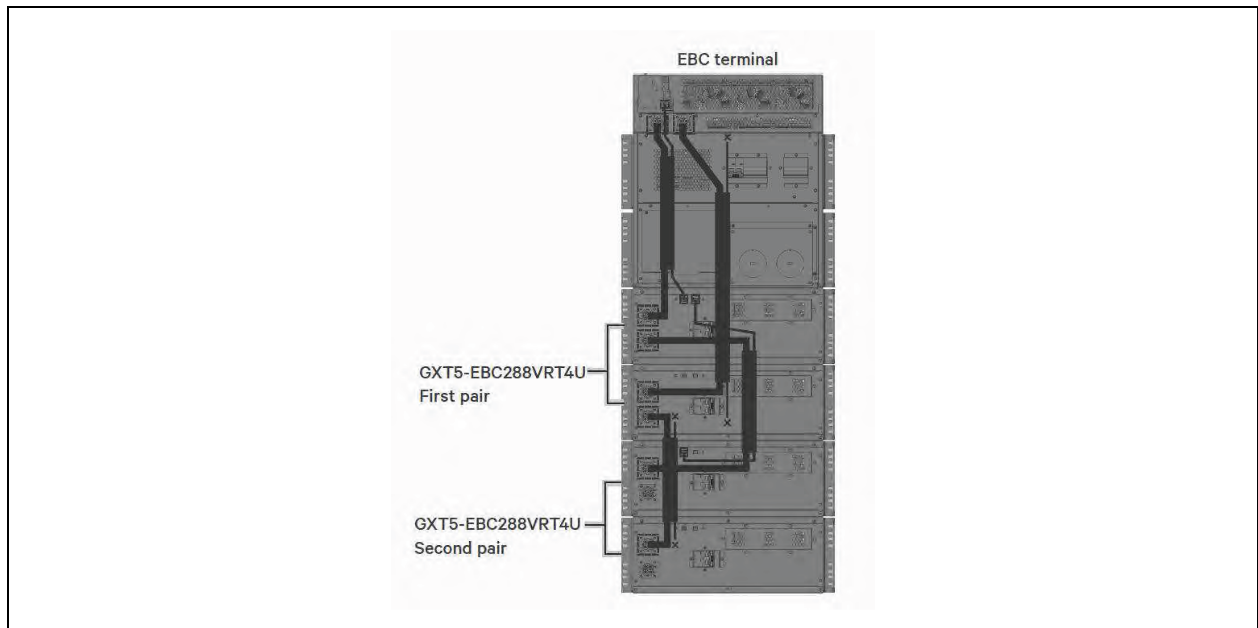

3.6 Installing the Power Output Distribution Box

- PD5-UL6HDWR-MBS, PD5-001, PD5-002, PD5-003, PD5-004, PD5-005 and PD5-006 models fit the GXT5-5000MVRT4UXLN and GXT5-6000MVRT4UXLN models of the Vertiv™ Liebert® GXT5.
- PD5-UL10HDWR-MBS, PD2-101, PD2-102, PD2-103, PD2-104, PD2-105, PD2-106, PD2-107, PD2-108, PD2-109, PD2-200, PD2-201, PD2-202, PD2-204 models fit the GXT5-8000MVRT6UXLN, GXT5-10KMVRT6UXLN, GXT5-15KMVRT11UXLN, and GXT5-20KMVRT11UXLN models of the Liebert® GXT5.

3.6.1 Installing the Power Distribution Box on GXT5-5000MVRT4UXLN and GXT5-6000MVRT4UXLN Models

PD5-UL6HDWR-MBS, PD5-001, PD5-002, PD5-003, PD5-004, PD5-005 and PD5-006 models assemble steps as follows:

1. Align the connectors and press the power distribution box onto the UPS.
2. Hold the box firmly against the UPS and tighten the captive screws except the one over the maintenance bypass breaker cover.
3. Confirm the maintenance bypass breaker *Off*.
4. Loosen the captive screw over the maintenance bypass breaker cover, pull down the cover and tighten the other screw on the UPS side of the cover.
5. Turn the output and input breakers *On*.
6. Start the UPS according to start-up instructions.

3.6.2 Installing the Power Distribution Box on GXT5-8000MVRT6UXLN and GXT5-10KMVRT6UXLN Models

PD2-101, PD2-102, PD2-103, PD2-104, PD2-105, PD2-106, PD2-107, PD2-108, PD2-109, PD2-200, PD2-201, PD2-202, PD2-204 models assemble steps as follows:



WARNING! Risk of electric shock. Can cause injury or death. The UPS must be shut down or the load must be transferred to an external maintenance bypass before a power distribution box may be added, changed or removed. If the UPS will be shut down, the connected load must be shut down. If the UPS will be transferred to maintenance bypass, it must be transferred to an external maintenance bypass. Verify that the GXT5 is shut down and that all local and remote electric input power has been disconnected before beginning any work on or in the UPS.

1. With the cover of distribution box removed, connect the UPS and distribution box connectors together. Ensure that the connectors are fully connected.
2. Align the screw holes and press the power distribution box onto the UPS, making sure that the tabs at the bottom of the box fit into the slots on the UPS.
3. Attach the box to the UPS by installing screws into the two holes at the top of the box.
4. Tighten the screws.
5. Turn the output and input breakers On.
6. Start the UPS according to start-up instructions.

3.7 Removing the Power Distribution Box from GXT5-5000MVRT4UXLN and GXT5-6000MVRT4UXLN Models

PD5-UL6HDWR-MBS, PD5-001, PD5-002, PD5-003, PD5-004, PD5-005 and PD5-006 models remove steps as follows:

1. Transfer the connected equipment to bypass mode.
 - a. Press and hold the **Power** button.
 - b. Select *Turn to bypass* and press **Enter**.

NOTE: The UPS transfers the connected loads to the internal bypass.

- c. Loosen the maintenance captive screw over the maintenance bypass breaker cover, pull up the cover and tight another screw, ensure the screw is on the ON location.(see the following figure for the breaker's location).
- d. Turn the maintenance bypass breaker *On*.

NOTE: The load is unprotected from disturbances in the power supply while the UPS is on bypass.

2. Please wait 1 minute if the UPS is operating in battery mode, then confirm the UPS has turned off.
3. Turn the output and input breakers *Off*.
4. Loosen other captive screws until the power distribution box releases.
5. Remove the power distribution box from the UPS and set it aside.
6. On the rear panel of the new UPS, remove the new power distribution box from the UPS.
7. Mount and connect the new UPS to the old power distribution box.

8. Turn on the UPS input and output breakers and allow the UPS to start up. The load will continue to be powered through the maintenance bypass breakers. See **Figure 3.7** on page 25 for details.
9. Ensure the UPS is operating in Bypass mode.
10. Turn off the maintenance bypass breaker and replace the upper connector cover screw.
11. Use the power button to switch the output to the UPS inverter.

Figure 3.5 Power Distribution Box Removal from GXT5-5000MVRTLN and GXT5-6000MVRT4UXLN

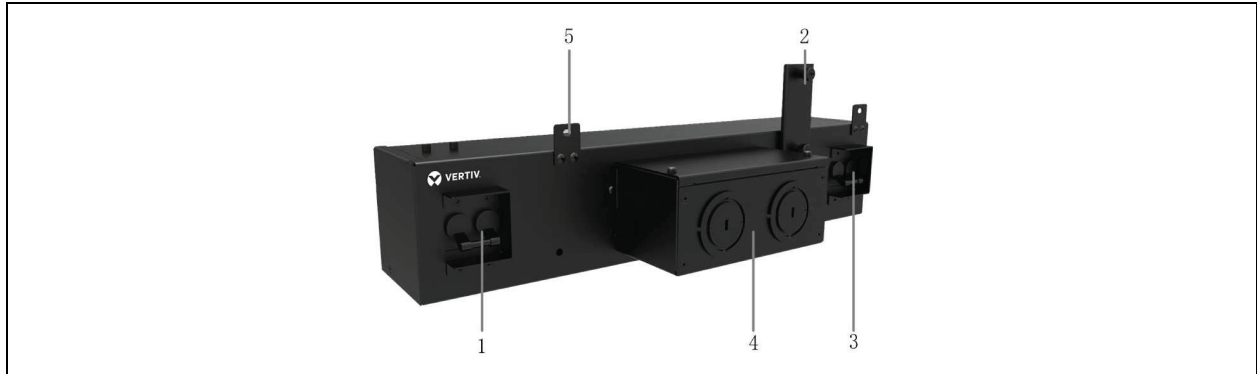

Item	Description
1	Output breaker
2	Maintenance bypass breaker screw
3	Input breaker
4	Knockouts for hard-wired power input and output
5	Screws

3.8 Removing the Power Distribution Box from GXT5-8000MVRT6UXLN and GXT5-10KMVRT6UXLN Models

PD2-101, PD2-102, PD2-103, PD2-104, PD2-105, PD2-106, PD2-107, PD2-108, PD2-109, PD2-200, PD2-201, PD2-202, PD2-204 models can be removed from the UPS by following these steps:

1. Shut down the Vertiv™ Liebert® GXT5.
 - a. Press and hold the **Power** button.
 - b. Select *Turn off UPS*, then press **Enter**. Power to the connected loads is now Off.
2. Turn the output and input breakers *Off*.
3. Support the power distribution box and remove the two screws at the top of the box.
4. When removing the power distribution box, carefully pull apart the power distribution box connector and the UPS connector.
5. Replace power distribution box cover and restart the UPS.

Figure 3.6 Power Distribution Box Removal from GXT5-8000MVRT6UXLN and GXT5-10KMVRT6UXLN Models

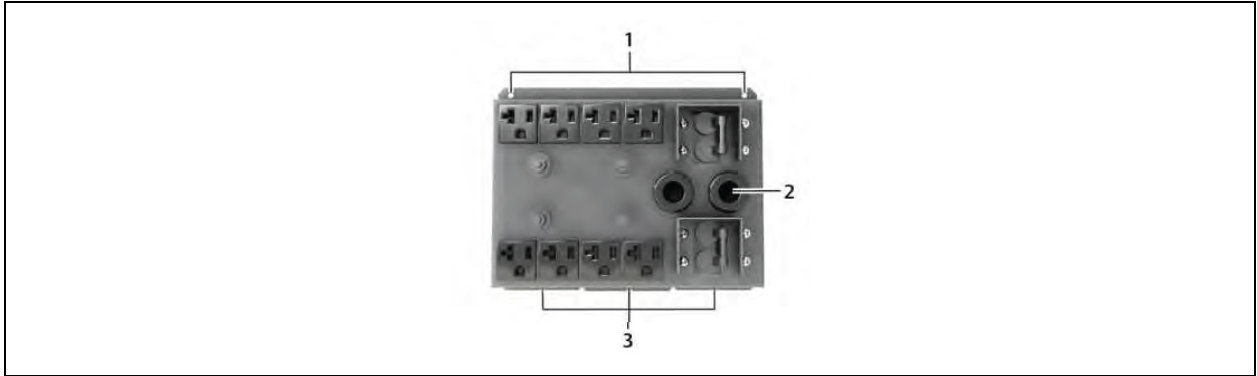

Item	Description
1	Remove screws
2	Pigtails removed for clarity
3	Tabs slip into slots on the UPS

3.9 Hardwired Input/Output Connections



WARNING! Risk of electric shock. Can cause equipment damage, injury and death. Before beginning installation, verify that all external over-current protection devices are open (Off), and that they are locked out and tagged appropriately to prevent activation during the installation, verify with a voltmeter that power is Off and wear appropriate, OSHA-approved personal protective equipment (PPE) per NFPA 70E. Failure to comply can cause serious injury or death. Before proceeding with installation, read all instructions. Follow all local codes.

Observe the following guidelines and specifications when making the hard wire input and output connections:

- We recommend installing a Class D UL489 approved breaker upstream of unit.
- Provide circuit breaker protection according to local codes. The mains disconnect should be within sight of the UPS or have an appropriate lock out.
- Maintain service space around the UPS or use flexible conduit.
- Provide output-distributions panels, circuit breaker protection, or emergency disconnects according to local codes.
- Do not install input and output wiring in the same conduit.
- On models with a cord connected input plug that is used as the power disconnect device, the UPS must be installed near a wall socket or outlet that is easily accessible per the National Electric Code/NFPA 70 requirements. Models/POD options subject to this requirement are: GXT5-5000MVRT4UXLN and GXT5-6000MVRT4UXLN with POD PD5-001, PD5-002, PD5-003, PD5-004, PD5-005, or PD5-006.

3.9.1 Branch Circuit Breaker

The installer must provide an upstream branch circuit breaker, see **Table 3.2** on the next page, for the ratings. The input circuit breaker on the distribution box and the output circuit breaker on the rear of the power distribution box disconnect all power between the main cabinet and the distribution box. **Figure 3.7** below, shows a diagram of the circuit breakers.

Observe the following guidelines and specifications when making the hard wire input and output connections:

- Provide circuit breaker protection according to local codes. The mains disconnect should be within sight of the UPS or have an appropriate lock out.
- Maintain service space around the UPS or use flexible conduit.
- Provide output distributions panels, circuit breaker protection, or emergency disconnects according to local codes.
- Do not install input and output wiring in the same conduit.

Models equipped with a manual bypass breaker pass bypass power directly to the bypass breaker from the input terminal block. The input circuit breaker on the distribution box does not disconnect power from the manual bypass breaker.

Table 3.1 Branch Circuit Breaker Rating

Model Number	Recommended External Circuit Breaker	Recommended External Overcurrent Protection When Using Optional PD5 PODs
GXT5-5000MVRT4UXLN	40A	30A
GXT5-6000MVRT4UXLN	40A	30A
GXT5-8000MVRT6UXLN	60A	N/A
GXT5-10KMVRT6UXLN	60A	
GXT5-15KMVRT11UXLN	125A	
GXT5-20KMVRT11UXLN	125A	

Figure 3.7 Circuit Breakers Diagram

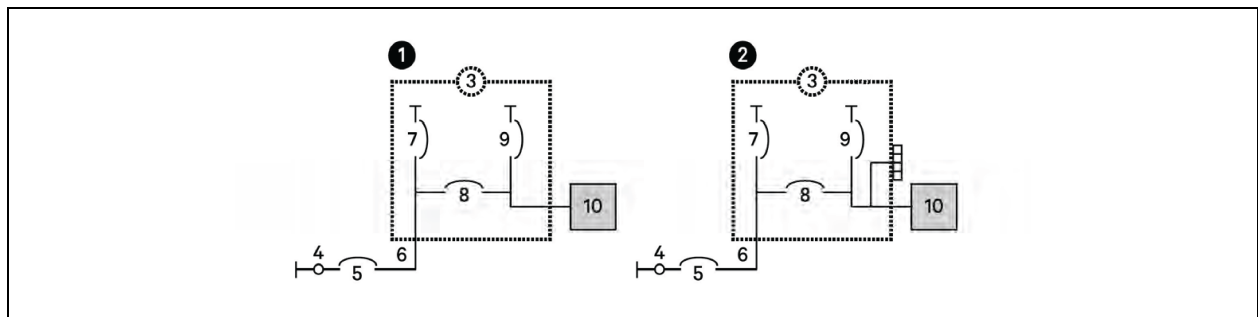

Item	Description
1	5 kVA and 6 kVA models
2	8 kVA through 20 kVA models
3	UPS
4	Mains/Utility

Item	Description
5	External branch circuit breaker
6	Input
7	Input circuit breaker
8	Maintenance bypass circuit breaker NOTE: 15 kVA and 20 kVA models do not include maintenance bypass
9	Output circuit breaker
10	Output-distribution POD

3.9.2 Terminal Block Connections

On 5 kVA through 10 kVA models, the hard wire connections to the terminal blocks are made through knockouts on the standard POD attached to the rear of the unit. On 15 kVA and 20 kVA models, the knockouts are located directly on the rear of the unit. See [Removable Power Distribution Box](#) on page 6, for the location of the input/output knockouts on your Vertiv™ Liebert® GXT5 model.

Table 3.2 below, details the electrical connection specifications.

Table 3.2 Terminal Block Electrical Specification

UPS Model	Recommended External Circuit Breaker	Recommended Wire Size (All Wires) (90°C Copper Wire)	Maximum Wire Size Accepted by Terminal Block	Terminal Lightening Torque
GXT5-5000MVRT4UXLN	40 A	10 AWG	4 AWG	20 lb-in (2.26 Nm)
GXT5-6000MVRT4UXLN		8 AWG		
GXT5-8000MVRT6UXLN	60 A	6 AWG		
GXT5-10KMVRT6UXLN				
GXT5-15KMVRT11UXLN	125 A	1 AWG	1/0 AWG	110 lb-in (5.65 Nm)
GXT5-20KMVRT11UXLN		1/0 AWG		

To make the terminal-block connections:

1. Loosen the screws from the cable-entry/conduit-box cover, and pull the cables through the cable-entry hole/knockout leaving some slack for connection.

NOTE: We are recommended using the knockouts to install input and output wiring in separate conduit. You must use a suitable cable gland or risk electric shock.

2. Referring to the appropriate terminal-block connection instructions, connect the cables to the corresponding input/output terminals and use a torque wrench to turn the screw clockwise until tightened as specified in **Table 3.2** above.
3. Re-install the cable-entry/conduit-box cover, and tighten the screws.

Figure 3.8 Terminal Block

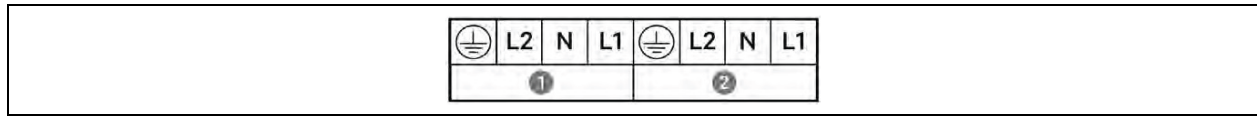

Item	Description
1	Output
2	Input

3.10 Communication Connection

The UPS offers several communication interfaces and ports.

NOTE: We recommend that signal-cable lengths be less than 10 ft (3 m), and are kept away from power cabling.

3.10.1 Connecting Liebert® IntelliSlot™ Communication

The Liebert® IntelliSlot™ RDU101 provides SNMP monitoring of the UPS across the network and/or building management system.

See the appropriate figure for your model in [Rear Panels](#) on page 4, for the location of the card port.

To install an Liebert® IntelliSlot™ Card:

1. Remove the screws from the slot cover plate and remove the plate.
2. Insert the card into the slot, and secure with the screws that held the cover plate.

To make connections to the card, refer to the Installer/User Guide for the appropriate IntelliSlot card available at www.Vertiv.com.

3.10.2 Connecting to the Dry Contact Port

The UPS includes a dry contact port. See the appropriate figure for your model in [Rear Panels](#) on page 4, for the location of the port. **Figure 3.9** below, shows the ports and **Table 3.3** on page 29, describes each port.

The I/O dry contact port capacity is 125 VAC, 0.5 A; 30 VDC, 1 A.

Figure 3.9 Dry Contact Port and Pin Layout

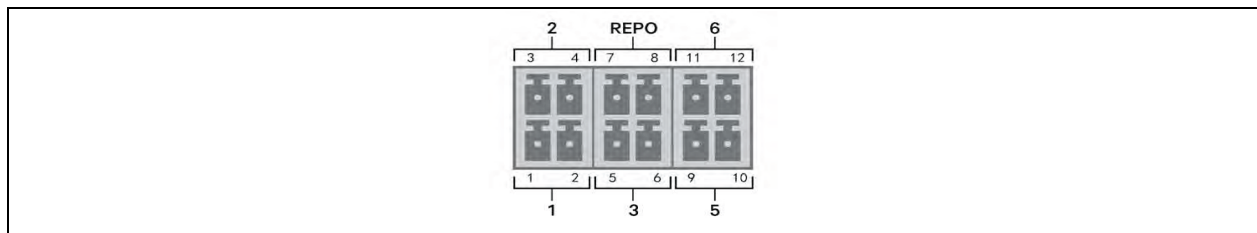

NOTE: Pins 7 and 8 are shorted before delivery.

NOTE: The emergency power off (EPO) action of the UPS closes the rectifier, inverter and static bypass, but it cannot disconnect the UPS mains input inside. To completely disconnect the UPS, disconnect the upstream input circuit breaker when generating the EPO. For details on REPO connection and operation, see [Connecting a Remote Emergency Power Off \(REPO\) Switch](#) on the facing page.

Table 3.3 Dry Contact Connection and Pin-out Descriptions

Port no.	Port Name	Pin No.	Pin Name	Description
1	Input 1	1	Remote Comms Shutdown 1	User configurable dry contact input that can be set to trigger the events below. The user can also select the dry contact as either NO or NC. (See System Parameter Options on page 45) When NO, Pins 1 and 2 are shorted to trigger the event. When NC, Pins 1 and 2 are opened to trigger the event. Options are: <ul style="list-style-type: none"> • Disable (default) • Battery mode shutdown - If the UPS is running on batteries and this input is triggered, the UPS shuts down • Any mode shutdown - If this input is triggered, the UPS shuts down regardless of current operating mode
		2	Signal Ground	Signal Ground
2	Input 2	3	Remote Comms Shutdown 2	User configurable dry contact input that can be set to trigger the events below. The user can also select the dry contact as either NO or NC. (See System Parameter Options on page 45) When NO, Pins 3 and 4 are shorted to trigger the event. When NC, Pins 3 and 4 are opened to trigger the event. Options are: <ul style="list-style-type: none"> • Disable (default) • Battery mode shutdown - If the UPS is running on batteries and this input is triggered, the UPS shuts down • Any mode shutdown - If this input is triggered, the UPS shuts down regardless of current operating mode.
		4	Signal Ground	Signal Ground
3	Battery Detection	5, 6	EBC Detection	Automatically detects number of external battery cabinets when pins 5 and 6 are connected to the detection port, see Installing External Battery Cabinets on page 19.
REPO	REPO Input	7	+5V	REPO power supply, 5 VDC 100 mA.

Table 3.3 Dry Contact Connection and Pin-out Descriptions (continued)

Port no.	Port Name	Pin No.	Pin Name	Description
		8	REPO Coil - NC	NC, activated when Pin 7 and Pin 8 is open NOTE: For details on REPO connection and operation, see Connecting a Remote Emergency Power Off (REPO) Switch below.
5	Output 5	9,10	Remote Fault Alert 5	User configurable dry contact output that can be set to alert the user to the faults below. The user can also select the dry contact as either NO or NC. (See System Parameter Options on page 45) When NO, Pins 9 and 10 are shorted when the fault occurs. When NC, Pins 9 and 10 are opened when the fault occurs. Options are: <ul style="list-style-type: none"> • Low battery (default) • On battery • On bypass • UPS fault
6	Output 6	11, 12	Remote Fault Alert 6	User configurable dry contact output that can be set to alert the user to the faults below. The user can also select the dry contact as either NO or NC. (See System Parameter Options on page 45) When NO, Pins 11 and 12 are shorted when the fault occurs. When NC, Pins 11 and 12 are opened when the fault occurs. Options are: <ul style="list-style-type: none"> • Low battery • On battery • On bypass • UPS fault (default)

3.10.3 Connecting a Remote Emergency Power Off (REPO) Switch

The UPS includes an EPO connection in the dry-contact port. See the appropriate figure for your model in [Rear Panels](#) on page 4, for the location of the port.

UPS ships with a REPO jumper installed, allowing the UPS to operate as a normally-closed switch system (fail-safe). Opening the circuit disables the UPS. To connect a REPO switch that opens the circuit to shut down the rectifier and inverter and power off the UPS, use a cable from the remote switch to plug into the REPO port on the UPS.

In normal conditions, the REPO switch cannot cut off the UPS input power. When the REPO switch trips, the UPS generates an alarm and immediately cuts-off battery charging and output power. When the emergency condition is resolved, the UPS will not return to normal operation until you reset the REPO switch and manually power on the UPS.

To make the cable for the REPO connection:

Figure 3.10 on the next page, shows the cable required to make the connection. We recommend using 18 AWG to 22 AWG (0.82 mm² to 0.33 mm²) copper-core cable.

1. Remove the insulation from the end of two cables.
2. Insert the stripped end into the plug terminals 1 and 2 respectively, then press down the terminals. Make sure that the cables are secure in the plug to prevent failure because of loose contact.

To connect a UPS to the REPO switch:



CAUTION: To maintain safety (SELV) barriers and electromagnetic compatibility, signal cables should be shielded and run separately from power cables.

1. Connect one end of the cable to the remote switch, see **Figure 3.10** below.
2. Remove the factory installed jumper from pins 7 and 8 of the dry contact port on the UPS.
3. Connect the plug to pins 7 and 8.

Figure 3.10 Cable/Plug for Connecting REPO switch to UPS REPO port

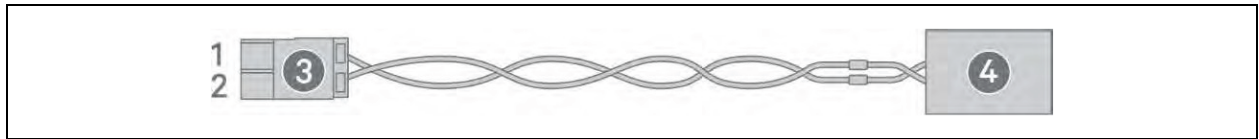

Item	Description
1	Terminal 1
2	Terminal 2
3	Plug (Connects to REPO port on UPS)
4	REPO switch

3.10.4 Connecting a USB Cable

The UPS includes a USB connector. See the appropriate figure for your model in [Rear Panels](#) on page 4, for the location of the port.

The standard, B-type USB port connects to a network server or other computer system. The USB port supports HID/CDC protocol. The CDC protocol is reserved for service software. To use the HID protocol for monitoring, get Power Assist from www.vertiv.com/PowerAssist.

3.10.5 Connecting CLI Communication Cables

The UPS supports the Vertiv command-line interface for operation with Vertiv ACS and other third party monitoring protocols. The RJ-45 port (labeled R232) is used for CLI connection. See the appropriate figure for your model in [Rear Panels](#) on page 4, for the location of the port. The pin-out, description in below table us consistent with the ACS pin-out.

Item	Description
1	NC
2	NC
3	TXD (out)
4	GND
5	NC

Item	Description
6	RXD (in)
7	NC
8	NC

This page intentionally left blank

4 Operating the UPS



WARNING! Risk of electric shock. Can cause injury or death. Hazardous mains and/or battery voltage exists behind the protective cover. No user accessible parts are located behind the protective covers that require a tool for removal. Only qualified service personnel are authorized to remove such covers. If maintenance for the UPS is needed, notice that the neutral line is live.

4.1 Silencing the Audible Alarm

The audible alarm may sound during UPS operation. To silence the alarm, press and hold the ESC button for 2 seconds. The button is located on the front panel display, see [Operation and Display Panel](#) on page 35.

4.2 Starting-up the UPS

IMPORTANT! Do not start the UPS until after the installation is finished, the system is commissioned by an authorized engineer, and the external input circuit breakers are closed.



CAUTION: Starting the UPS applies mains/utility power to the output terminals. Make sure that the load power is safe and ready to accept power. If the load is not ready, isolate the load with the output terminal.

The UPS starts in Normal Mode.

To start the UPS:

1. If included on your UPS model, make sure the maintenance bypass switch is in the open *OFF* position and that the guard is secured in place.
2. Ensure that the REPO connector on the rear of the unit has a jumper between pins 7-8 or that it is properly wired to an Emergency Power off circuit (normally closed).
3. Make sure the breaker supplying power to the UPS is closed, and if necessary, press the input circuit breaker reset buttons at the rear of the UPS.
4. Close all output breakers on the rear of the UPS (or in an external panel board, if used).
5. If external battery cabinets are attached, close the breakers on the rear of each cabinet.
6. Power on the UPS by pressing and holding the power button on the operation and display panel until the confirmation dialog appears. Use the Up/ Down arrows to select *YES*, then press **Enter**.
7. If this is the first time start-up of the UPS, the Start-up Guidance wizard opens to set the basic parameters of the UPS. Follow the prompts.

For detailed description of UPS display functions and settings, see [Operation and Display Panel](#) on page 35.

4.3 Transferring to Battery Mode

The UPS operates in Normal mode unless the mains/utility power fails or it is performing a battery self test, then it automatically transfers to Battery mode for the back-up time available or the mains/utility power is restored. Once input power is restored, the UPS returns to Normal mode.

NOTE: Battery back-up run times are listed in [Battery Run Times](#) on page 69.

4.4 Transferring from Normal to Bypass Mode

Press and hold the power button for 2 seconds.

If the UPS is operating normally, without faults, the option to continue to turn-on or turn-off the UPS displays:

- a. Use the arrow buttons to select *Turn on UPS* or *Turn off UPS*, and press **Enter**.
- b. Use the arrow buttons to select *No* or *Yes*, then press **Enter** to confirm.

If the bypass power is outside normal operating range, the option turn-off the UPS displays. Use the arrow buttons to select *No* or *Yes*, then press **Enter** to confirm.

4.5 Transferring from Bypass to Normal Mode

Press and hold the power button for 2 seconds.

If the UPS is operating normally, without faults, the option to continue to turn-on or turn-off the UPS displays:

- a. Use the arrow buttons to select *Turn on UPS* or *Turn off UPS*, and press **Enter**.
- b. Use the arrow buttons to select *No* or *Yes*, then press **Enter** to confirm.

NOTE: The UPS automatically switches back to normal mode after an *overheated* or *overloaded* fault is cleared and normal power is restored.

4.6 Shutting Down the UPS Completely



WARNING! Risk of electric shock. Can cause injury or death. Disconnect all local and remote electric power supplies before working with the UPS. Ensure that the unit is shut down and power has been disconnected before beginning any maintenance.

Transfer to Bypass mode, see [Transferring from Bypass to Normal Mode](#) above. Then, if power to the load is not needed, open the main-input circuit breaker.

For systems with direct power distribution, isolate the UPS from AC power by disconnecting the external input MCB. If the main and bypass are independently powered, close the two input MCBs.

4.7 Remote Emergency Power Off (REPO)

REPO turns off the UPS in emergency conditions such as fire or flood. When an emergency occurs, the REPO switch turns off the rectifier and inverter and stops powering the load immediately. The battery stops charging and discharging.

To manually power off in an emergency, disconnect the terminal connecting the REPO port on the rear of the UPS.

If mains/utility power is present, the UPS control circuit remains active even though output power is disabled. To remove all mains/utility power, disconnect the external main-input circuit breaker.

5 Operation and Display Panel



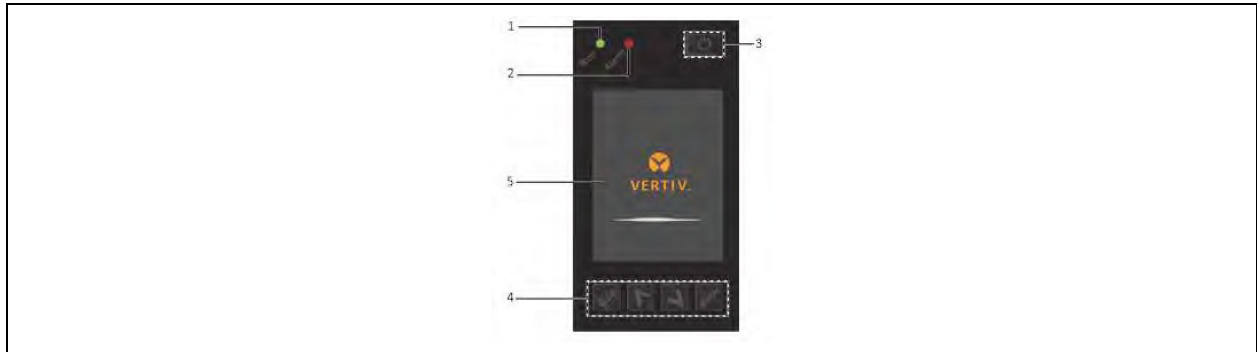

The operation/display panel includes LED indicators, function keys, and an LCD interface to configure and control UPS operation.

Figure 5.1 UPS Front panel Display



Item	Description
1	Run indicator LED, see LED Indicators on the next page.
2	Alarm indicator LED, see LED Indicators on the next page.
3	Power button, see Table 5.1 below.
4	Menu keys, see Table 5.1 below.
5	LCD panel.

Table 5.1 Display Panel Button Functions and Descriptions

Button	Function	Description
	Enter	Confirm or enter selection.
	Up	Move to previous page, increase value, move left.
	Down	Move to next page, decrease value, move right.
	Escape	Go back.
	Power	Power on the UPS, power off the UPS, transfer to bypass mode.

NOTE: While the UPS is operating, the LCD will dim and display a screen saver if there is no active alarm or user interaction for two minutes, see **Figure 5.2** below. If an alarm or fault occurs or if any button is pressed, the UPS flow screen displays.

NOTE: Do not rotate display, and follow handling instructions (pick up only from sides, do not use any plastic parts to support the weight of the UPS).

Figure 5.2 LCD Screen Saver

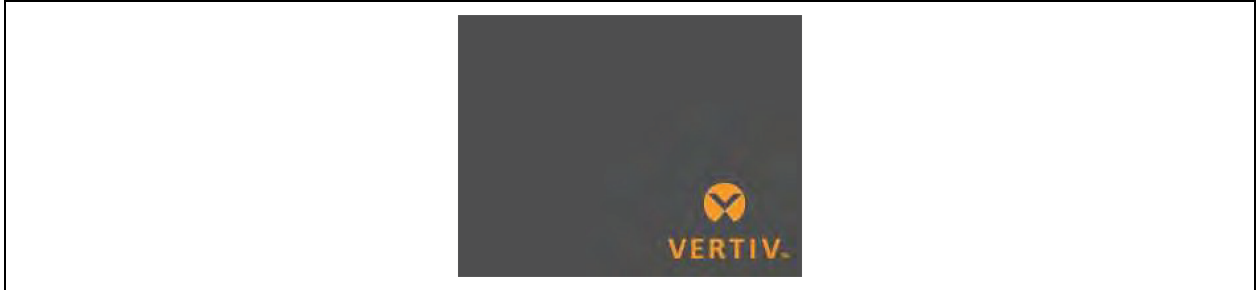

5.1 LED Indicators

The LEDs on the front panel display indicate operation and alarm statuses of the UPS.

NOTE: When an alarm is indicated, an alarm message is logged on **Table 5.4** on page 52, describes the alarm messages you may see. When a fault is indicated, front panel display list the fault, which are described in **Table 7.2** on page 64.

Table 5.2 LED Functions

Indicator	LED Color	LED State	Indicates
Run indicator	Green	On	UPS has output
		Blinking	Inverter is starting
		Off	UPS has no output
Alarm indicator	Yellow	On	Alarm occurs
	Red	On	Fault occurs
	None	Off	No alarm, no fault

5.2 LCD Menu and Screens

The menu-driven LCD user interface lets you browse the UPS status, view operating parameters, customize settings, control operation, and view alarm/event history. Use the function keys to navigate through the menu, and view statuses or select settings in the screens.

5.2.1 Start-up and Flow Screens

At start-up, the UPS executes a system test and displays the Vertiv logo screen for about 10 seconds, shown in **Figure 5.1** on the previous page. After the test completes, an overview screen shows status information, the active (green) power path, and the non-working power path (gray).

NOTE: Figure 5.3 below is an example flow screen and does not reflect the actual values that you may see on your unit.

Figure 5.3 UPS Flow Screen

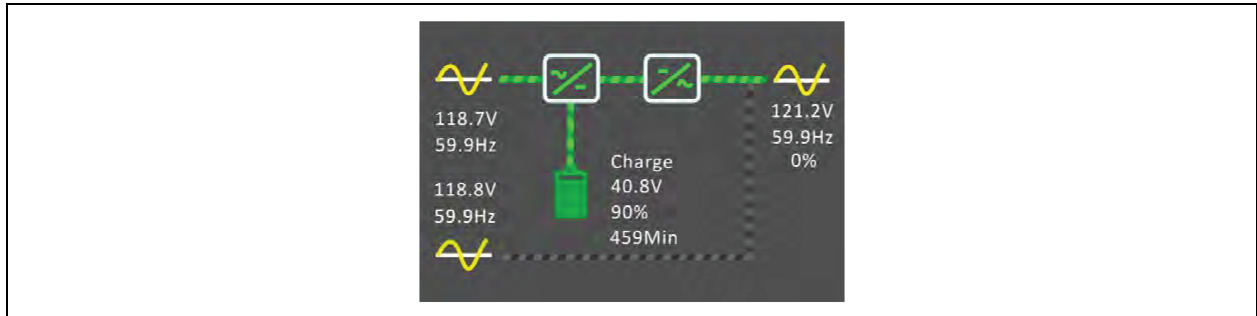

5.2.2 Main Menu

To access the main menu, press **Enter** while at the flow screen. **Table 5.3** below, describes the menu options, and **Figure 5.4** below, describes the display.

Use the arrow buttons to select the sub-menu options, and press **Enter** to open the sub menu. Press ESC to return to the flow screen.

Table 5.3 Menu Options

Item	Description
Status	Voltage, current, frequency, and parameters for UPS components, see Status Screen on the next page.
Setting	Display and system parameter settings, see Settings Submenu on page 41.
Control	UPS controls, see Control Screen on page 47.
Log	Current alarms and event history, see Log Screen on page 48.
About	Product and network information, see About Screen on page 52.
Maintenance	Service only, service password protected page for use only by Vertiv service representatives.

Figure 5.4 Main Menu

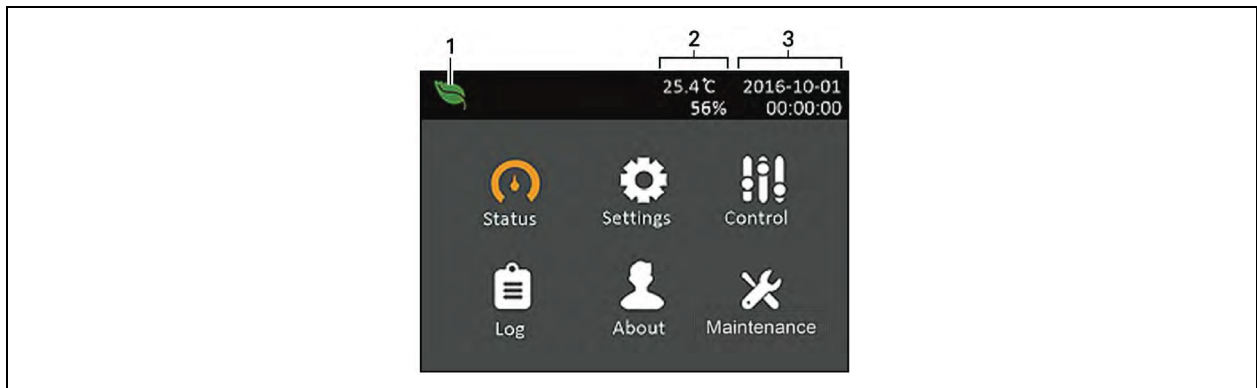

Item	Description
1	ECO mode indicator
2	Programmable outlet indicator
3	Ambient temperature and humidity. Only displays when sensors are connected.

5.2.3 Status Screen

The status screen displays voltages, currents, frequencies, and parameters on individual tabs for input, bypass, battery, output, and load status.

To view the UPS status information:

1. At the main menu, select the Status icon, and press **Enter**.
2. Use the arrow buttons to move the cursor left/right and select a tab, then press **Enter** to display the status information for the selected tab.

Figure 5.5 Status Screen Tabs

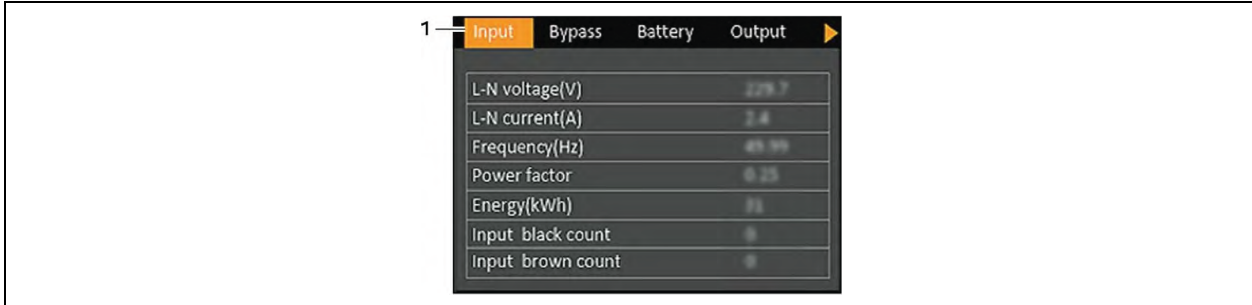

Item	Description
1	Screen tabs with Input tab selected

NOTE: Multiple phases are shown in multiple columns. For example, a unit with three-phase input will display 3 columns of status data.

Input Status Options

L-N voltage (V)

Line-neutral voltage of input power.

L-N current (A)

Line-neutral current of input power.

Frequency (Hz)

Frequency of input of input power.

L-L voltage(V)

Line-line voltage of input power.

Power Factor

Power factor of the input power.

Energy (kWh)

Input power.

Input black count

The number times that the input voltage was lost or dropped below 60 VAC (black out). Resets to 0 when UPS is powered down.

Input brown count

The number of times that the input voltage was too low to support the load and the UPS was forced to switch to battery power (brown out). Resets to 0 when the UPS is powered down.

Bypass Status Options**L-N voltage (V)**

Line-neutral voltage of bypass power.

Frequency (Hz)

Frequency of bypass power.

L-L voltage(V)

Line-line voltage of bypass power.

Battery Status Options**Battery status**

Current battery state: charging, discharging, or fully charged.

Battery voltage (V)

Voltage of battery power.

Battery current (A)

Current of battery power.

Backup time (Min)

Amount of back-up time remaining for battery.

Remaining capacity (%)

Percent of capacity remaining for battery.

Discharge count

Number of discharges for the battery module.

Total discharge time (Min)

Number of minutes until battery is fully discharged.

Battery running time (Day)

Number of days the batteries have been in operation.

Battery replacement time

Date of last time battery was replaced.

External battery cabinet group No.

Number of external battery cabinets connected.

Battery average temp (°C)

Average temperature of the battery.

Battery highest temp (°C)

Highest temperature battery has reached.

Battery lowest temp (°C)

Lowest temperature battery has reached.

Output Status Options

L-N voltage (V)

Line-neutral voltage of output power.

L-N Current (A)

Line-neutral current of output power.

Frequency (Hz)

Frequency of output power.

L-L voltage(V)

Line-line voltage of output power.

Energy (kWh)

Output power

Load Status Options

Sout (kVA)

Apparent output power.

Pout (kW)

Active output power.

Power Factor

Power factor of output power.

Load percent (%)

Percentage of recent power rated to output power.

5.2.4 Settings Submenu

The settings screen consists of tabs that list UPS settings for configuration and adjusting parameters with tabs for:

- Output
- Battery
- Monitor
- System

NOTE: Do not change parameter settings or reset to factory defaults when powering-off the UPS.

To modify UPS settings:

1. At the main menu, select the Settings icon, and press **Enter**.

Output Parameter Options**Voltage selection**

Nominal voltage setting. Set the nominal system voltage to match the input voltage of the UPS.

- 100/173V
- 100/173RVS (L1/L2 reversed)
- 100/200V
- 110/190.5V
- 110/190.5RVS (L1/L2 reversed)
- 110/220V
- 115/199V
- 115/199RVS (L1/L2 reversed)
- 115/230V
- 120/208V (default)
- 120/208RVS (L1/L2 reversed)
- 120/240V
- 125/216.5V
- 125/216.5RVS (L1/L2 reversed)
- 125/250V
- Autodetect (default)

Startup on bypass

Allows the UPS to start-up in bypass mode.

- Enable — Start the UPS in bypass mode
- Disable — Start the UPS in normal mode. (default)

Frequency selection

Selects the frequency of the output. Options are:

- Auto, Bypass enabled — Automatically detects frequency of utility/mains power and sets the nominal frequency to match and bypass mode is enabled (default).
- Auto, Bypass disabled — Automatically detects frequency of utility/mains power and sets the nominal frequency to match and bypass mode is disabled.
- 50 Hz — Bypass mode is disabled and the UPS provides 50-Hz output from any qualified utility/mains power.
- 60 Hz — Bypass mode is disabled and the UPS provides 60-Hz output from any qualified utility/mains power.

Bypass voltage upper limit

Sets the percentage that the input voltage may be above the selected output voltage setting and remain in Bypass mode.

- +10% (default)
- +15%
- +20%

Bypass voltage lower limit

Sets the percentage that the input voltage may be below the selected output voltage setting and remain in Bypass mode.

- -10%
- -15% (default)
- -20%

Run mode

Selects Normal or ECO operation for the UPS. Options are:

- Normal — Connected load is always powered through the UPS inverter. ECO mode is disabled (default).
- ECO mode — ECO mode is enabled. The UPS inverter is bypassed, and the connected load is powered by utility/mains power within the selected ECO voltage and frequency tolerances.

ECO voltage range

(Option only available when Run mode is set to ECO). Sets the percentage that the input voltage may be above or below the selected output voltage setting and remain in ECO mode.

- ±5%
- ±10% (default)
- ±15%

ECO frequency range

(Option only available when Run mode is set to ECO). Sets the amount that the input frequency (Hz) may be above or below the selected frequency setting and remain in ECO mode.

- ±1 Hz
- ±2 Hz
- ±3 Hz (default)

ECO requalification time

(Option only available when Run mode is set to ECO). To ensure the stability of the utility/mains power, this is the length of time that the UPS requires the input voltage and frequency tolerances to be maintained before switching to ECO-mode.

- 1 min (default)
- 5 min
- 15 min
- 30 min

Battery Parameter Options**Low battery time**

Sounds an alarm when the selected amount of time remaining for the UPS to operate in Battery mode.

- 2 - 30 minutes (default is 2)

Battery periodic test

The UPS can periodically self-test the battery.

- Enable (default)
- Disable

Battery periodic test interval

Sets the length of time between periodic test.

- 8, 12, 16, 20, or 26 weeks (default is 8)

Battery periodic test weekday

Sets the day of the week that the battery periodic test is performed.

- Sunday - Saturday (Wednesday is default)

Battery periodic test time

Sets the time that the battery periodic test is performed.

- 00:00 - 23:59 (default is 00:00)

Battery remainder (months)

Sets the length of time after the batteries are replaced to generate an alarm to remind the user to replace the batteries.

- Disable (default)
- 1 - 72 months

Dischg protect time

Sets the maximum discharge time for the UPS. The default setting is the maximum allowing the battery to fully discharge. This can be set lower to limit the amount of time the UPS will provide battery protection after which it will shut down. If the discharge time remaining on the battery is lower than the setting value, it will have no effect.

- 1 - 4320 minutes (default of 4320)

Replace battery

Activates newly installed battery packs after replacement and reset all battery statistics for new battery packs.

- Provides a confirmation window with Yes/No options to confirm replacement of batteries.

Monitor Settings Options**Language**

Selects the language of the display, see [Selecting the Display Language](#) on page 56. Options are:

- English (default)
- French
- Portuguese
- Spanish
- Chinese
- German
- Japanese
- Russian

Date

Selects the current date for the UPS display, YYYY-MM-DD. See [Setting the Date and Time](#) on page 56.

Time

Select the current time for the UPS display, HH:MM:SS. See [Setting the Date and Time](#) on page 56.

Display orientation

Selects the orientation of the display for use in rack or tower configuration. Options are:

- Auto-rotate — Automatically rotates based on the detected orientation of the UPS. (default)
- Horizontal — Screen rotated for rack use.
- Vertical — Screen rotated for tower use.

Audible alarm

If enabled, the UPS will beep when an alarm is generated. If disabled, it will be silent. See [Audible Alarm \(Buzzer\)](#) on page 63.

- Enable (default)
- Disable

Change settings password

Opens the dialog to change the password used to access and update the UPS parameter settings, see [Changing the Password](#) on page 55.

System Parameter Options

Auto restart

Allows the automatic restart of the UPS when input power is restored after a complete shutdown of the UPS due to battery end of discharge (EOD).

- Enable — The UPS will restart automatically when the input power is restored after EOD (default).
- Disable — The UPS will not restart automatically.

Auto restart delay

Length of time to elapse before an automatic restart after input power is restored.

- 0 - 999 seconds (default 0)

Guaranteed shutdown

Forces a continued shutdown of the UPS after the Low Battery alarm threshold is reached, even if input power is restored during this time. This can be used to ensure connected equipment shuts down completely after receiving a signal to shutdown from an external monitoring device before power is re-applied. This ensures that once the equipment begins to shut down, it is brought down completely before power is applied again.

- Enable
- Disable (default)

Start with no battery

Allows the UPS to start when the battery is not installed or is not functional due to damage. This can be used to turn on the UPS and power the attached load without battery protection when utility power is available but battery backup is not.

- Enable
- Disable (default)

Remote control

Allows the UPS to be controlled remotely via the CLI or RDU101 card.

- Enable (default)
- Disable

Any mode shutdown auto restart enable

Automatically restart the UPS after an *Any mode shutdown* signal is received. When the UPS is shut down via dry contact inputs 1 or 2, it will restart automatically if this option is enabled.

- Enable
- Disable (default)

Output contact NO/NC

Selects the states of the dry contact outputs 5 and 6.

- Normally open (default)
- Normally closed

Input contact NO/NC

Selects the states of the dry contact inputs 1 and 2.

- Normally open (default)
- Normally closed.

Dry contact 5 (Output)

Selects the output of dry contact 5:

- Low battery — The contacts switch when the UPS reaches the amount of time left on battery configurable from *Low battery time*. (default)
- On bypass — The contacts switch when the UPS is running in bypass mode
- On battery — The contacts switch when the UPS is running on battery
- UPS fault — The contacts switch when a UPS fault has occurred

Dry contact 6 (Output)

Selects the output of dry contact 6:

- Low battery — The contacts switch when the UPS reaches the amount of time left on battery configurable from *Low battery time*.
- On bypass — The contacts switch when the UPS is running in bypass mode
- On battery — The contacts switch when the UPS is running on battery
- UPS fault — The contacts switch when a UPS fault has occurred. (default)

Dry contact 1 (Input)

Selects the action taken by the UPS when the input of dry contact 1 is triggered:

- Disable (default)
- Battery mode shutdown — If the UPS is running on batteries and this input is triggered, the UPS shuts down
- Any mode shutdown — If this input is triggered, the UPS shuts down regardless of current operating mode

Dry contact 2 (Input)

Selects the action taken by the UPS when the input of dry contact 2 is triggered:

- Disable (default)
- Battery mode shutdown — If the UPS is running on batteries and this input is triggered, the UPS shuts down
- Any mode shutdown — If this input is triggered, the UPS shuts down regardless of current operating mode

Sleep mode

Allows the UPS to turn off the output on a weekly schedule. For instance, turn on every Monday at 1:00 and off every Friday at 23:00.

- Enable
- Disable (default)

Power on day of week

Sets the day of week to turn on the UPS. This option is only shown when sleep mode is enabled.

- Sunday-Saturday (default Monday)

Power on time

Sets the time of day to power on the UPS on the selected day. This option is only shown when sleep mode is enabled.

- 00:00 - 23:59 (default 00:00)

Power off day of week

Sets the day of week to turn off the UPS. This option is only shown when sleep mode is enabled.

- Sunday-Saturday (default Friday)

Power off time

Sets the time of day to power off the UPS on the selected day. This option is only shown when sleep mode is enabled.

- 00:00 - 23:59 (default 00:00)

IT system compatibility

When this option is enabled, the *Input phase reversed* and *Input ground lost* alarms are disabled.

- Enable
- Disable (default)

5.2.5 Control Screen

The Control screen offers UPS-control options.

To adjust the UPS controls:

1. At the main menu, select the Control icon, and press **Enter**.
2. Use the arrow buttons to move the cursor to the option, then press **Enter**.

Figure 5.6 Control Screen

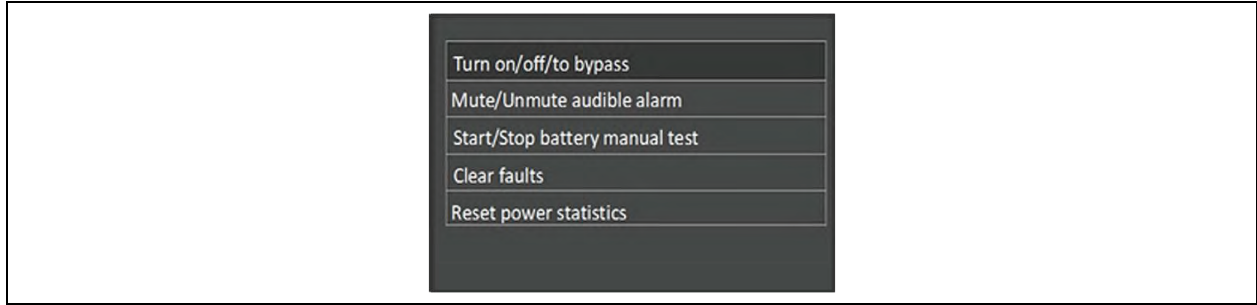

Control Options

Turn on/off/to bypass

Opens the dialog to change operating modes, see [Operating the UPS](#) on page 33.

Mute/Unmute audible alarm

Silences or un-silences the audible alarm, see [Silencing the Audible Alarm](#) on page 33.

Start/Stop battery manual test

Starts the battery self test manually. If the manual self test is already running, stop the self test.

Clear faults

Clears displayed faults after the issue causing the fault is resolved, see [Table 7.2](#) on page 64, for a description of the faults.

Reset power statistics

Resets the values tracked to calculate the Efficiency graph, see [About Screen](#) on page 52.

5.2.6 Log Screen

The Log Screen offers tabs that list the current alarms and the alarm/event history. [Table 5.4](#) on page 52, describes the alarm messages you may see in the logs.

To view the logs:

1. At the main menu, select the Log icon, and press **Enter**.
2. Use the arrow buttons to move the cursor left/right and select a tab, then press **Enter** to display the log for the selected tab.

Figure 5.7 Current and History Log Tabs

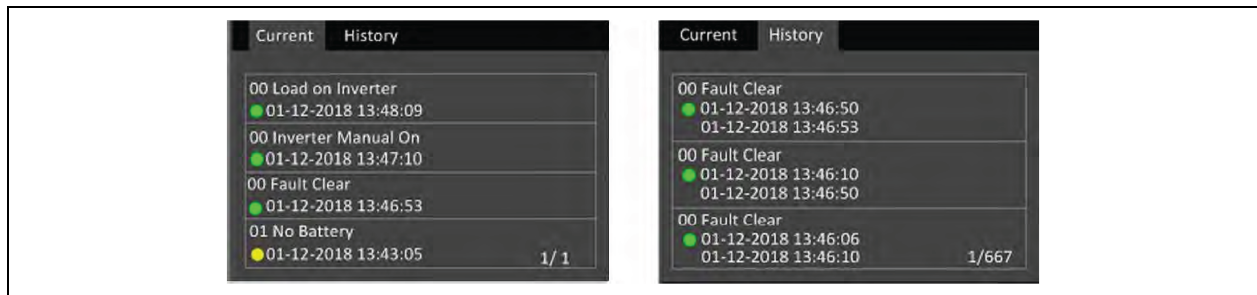

Table 5.4 Alarm Message

Message	Description
Aux. power fault	UPS internal auxiliary power voltage fault. Contact Vertiv Technical Support.
Battery cabinet connect abnormal	More than 6 external battery cabinets are connected to the UPS with the auto-detect feature in use. Contact Vertiv service if using more than 6 EBCs.
Battery aged	The battery is old and at the end of its useful life. Replace the battery.
Battery EOD	The battery has reached the end of discharge and mains/utility power is unavailable. Restore the mains power. The UPS will power off if it is not restored.
Battery low pre-warning	This alarm occurs when the battery approaches the EOD. After the pre-warning, the battery capacity allows two minutes discharge at full load. The user can set the time with the Low Battery Time setting in Battery settings from 2 min - 30 min, (2 min by default). This allows for any loads to be shut down before the system powers off if utility power cannot be restored.
Battery mode	The UPS operating in battery mode. The alarm will clear when utility power is restored.
Battery overtemp	Battery ambient temperature too high. Ensure that the battery ambient temperature is not higher than setting value 40 ~ 60 °C (default: 50 °C)
Battery replacement timeout	The system time is past the time set for the batteries to be replaced. If you have disabled the <i>Batt. note duration</i> or have no batteries installed, the alarm will not occur.
Battery reversed	The battery positive and negative are reversed. Reconnect the battery and check the battery cable connections.
Battery test fail	The remaining energy at the end of the periodic or manual self-test was deemed lower than acceptable. Battery replacement is recommended.
Battery test started	The battery periodic self-test or manual self-test was started. This will display in the log whenever the event occurs.
Battery test stopped	The battery periodic self-test or manual self-test has finished. This will display in the log whenever the event occurs.
Battery to utility transition	The UPS has transferred the load to the mains power from the battery. This will display in the log whenever the event occurs.
Battery voltage abnormal	The battery voltage exceeds the normal range. Check if the battery terminal voltage exceeds the normal range.
Battery to utility transition	The UPS has transferred the load to the mains power from the battery. This will display in the log whenever the event occurs.
Bypass voltage abnormal	The battery voltage exceeds the normal range. Check if the battery terminal voltage exceeds the normal range.

Table 5.4 Alarm Message (continued)

Message	Description
Bypass abnormal	May be caused by bypass voltage and frequency outside of range, bypass power off and incorrect bypass cables connection. Check that the bypass voltage and frequency are within the setting range. Check the bypass wiring
Bypass abnormal in ECO mode	May be caused by ECO bypass voltage and frequency outside of range, ECO bypass power off, and incorrect ECO bypass cables connection. Check that the ECO bypass voltage and frequency are within the setting range. Check the bypass cable connection.
Bypass mode	The UPS is on bypass. This will clear when the UPS returns to Normal mode.
Bypass over-current	The load is drawing more current than the UPS is rated to supply in bypass mode. Reduce the load.
Charger fault	The charger output voltage is abnormal, and the charger is off. Contact Vertiv Technical Support.
Communication fail	Internal communication is abnormal. Check that the communication cables are connected correctly.
DC bus abnormal	The inverter is off due to DC bus voltage out of acceptable range. The load will transfer to bypass if the bypass is available because the bus voltage is outside of the acceptable range.
DC/DC fault	The discharger is faulty, because the bus voltage exceeds the range when the discharger starts. Contact Vertiv Technical Support.
EOD turn off	The inverter is off due to EOD. Check the mains power off state and recover the mains in time.
Fan fault	At least one fan is faulty. Check if the fan is blocked or the cable connection is loose.
Faults cleared	The faults have been cleared using Settings > Controls > Clear faults. This will display in the log whenever the event occurs.
Guaranteed shutdown	The battery has finished discharging, then system shuts down because Guaranteed Shutdown is enabled (see Guaranteed shutdown on page 45). This alarm will clear when the UPS is turned on again.
Input abnormal	The rectifier and charger are off due to the mains voltage and frequency exceeding normal range. Check if the input voltage and frequency are within the normal range or if the mains input has gone down.
Input ground lost	Check that the PE line is well connected and that the alarm can be cleared at the display.
Input neutral lost	The mains input neutral is not detected. The alarm will clear when the neutral connection has been restored.
Input phase reversed	The mains input line and neutral are reversed. Shut off external input breaker and connect the lines correctly.
Insufficient capacity to start	The UPS is on bypass and is started with a load greater than 105% of the rated capacity. Reduce the load to the rated capacity or below to start the unit.
Inverter fault	The inverter is turned off when the inverter output voltage or current exceed the ranges set. If bypass is available, the UPS will transfer to bypass mode, otherwise the system will power off. Contact Vertiv Technical Support.
Inverter overload	Inverter load capacity is larger than the rated value, overload delay time is up, inverter shuts down. If bypass is available, the system will transfer to the bypass mode, otherwise the system will power off. Check the output load. If overloaded, reduce the load, and the system will transfer to the inverter mode after five seconds with no alarm.
Inverter relay welded	The inverter relay is shorted. Contact Vertiv Technical Support.
Load off due to output short	A short has occurred on the output. Check the output cables and for any equipment that may have shorted.
Load off due to shutdown on battery	The system was shut down in battery mode. This will clear when the system is turned back on.
Manual power on	The system was turned on via the display panel. This will display in the log whenever the event occurs.

Table 5.4 Alarm Message (continued)

Message	Description
Manual shutdown	The system was shut down via the display panel. This will display in the log whenever the event occurs.
No battery	No battery detected. Check the battery and battery cable connections.
On maintenance bypass	The UPS is operating in maintenance bypass mode. This will display in the log whenever the event occurs.
Operating on inverter	The UPS output is being powered by the inverter. This will display in the log whenever the event occurs.
Output disabled	The system is in standby state, and the dry contact shutdown is enabled. Check if the shutdown dry contact is enabled.
Output off due to bypass abnormal	The bypass voltage or frequency is outside the acceptable range, and the bypass is in stand-by mode. Check that the input is normal.
Output off due to overload and bypass abnormal	The output is off due to an overload of the UPS output, and the bypass voltage or frequency is outside the acceptable range. Check that the input is normal.
Output off, voltage is not zero	This occurs when the output is off and the system detects that there is still voltage on the output. Check output equipment for backfeeds or contact Vertiv Technical Support.
Output pending	Remote shutdown has been initiated, and the system will turn off shortly.
Output short	A short has occurred on the output. Check the output cables and for any equipment that may have shorted.
Rectifier fault	The rectifier is off because the bus voltage is out of the acceptable range when the rectifier starts. Contact Vertiv Technical Support.
Rectifier overload	The output power is larger than the rectifier overload point. Check that the input voltage meets the output load, if the mains input falls to 176 V - 100 V, the load is derated linearly from 100% - 50%.
Remote power on	The UPS was powered on remotely. This will display in the log whenever the event occurs.
Remote shut-off	The UPS was powered off remotely. This will display in the log whenever the event occurs.
Remote shutdown	Any mode shutdown was initiated by the dry contact input. This will display in the log whenever the event occurs.
REPO	Shutdown caused by the REPO terminal Normally-Closed contact input opening. This will display in the log whenever the event occurs.
Restore factory defaults	On the Maintenance page, <i>Restore Factory Defaults</i> has been set while the UPS is in the stand-by state. This will return settings to their factory settings.
Shutdown due to over temp	During the UPS operation, the system checks if the heat sink temperature exceeds the setting range. If an overtemperature, occurs, check if: <ol style="list-style-type: none"> 1. The ambient temperature is too high. 2. Dust is blocking any of the UPS vents. 3. A fan fault has occurred.

Table 5.4 Alarm Message (continued)

Message	Description
System over temp	Internal heat sink temperature is too high, and the inverter is off. The alarm can only be silenced if the heat sink temperature is lower than the alarm setting. The system can automatically start after overtemperature fault is corrected. If an overtemperature occurs, check if: <ol style="list-style-type: none"> 1. The ambient temperature is too high. 2. Dust is blocking any of the UPS vents. 3. A fan fault has occurred.
Turn on fail	The UPS does not start because there is no mains/utility power or it is outside of the range of the voltage required to supply the full load. Check the AC input power.
UPS has no output	Both Inverter and Bypass are not supplying power due to the UPS output being turned off remotely or via the LCD or are unavailable due to no input power or input power out of range. Check that UPS is on and input power is available.

5.2.7 About Screen

The About screen offers tabs that list information about the product.

- Product tab—shows UPS identification information, firmware versions, and information about the communication card (when the card is installed).
- Efficiency tab—shows curve of the efficiency of your UPS model vs the load. The efficiency at the current load is shown to the right of the graph.
- Battery age tab—Shows the curve of the state of health (SOH) percentage of the installed battery over time. The SOH is measurement of the installed battery's condition and ability to deliver the specified performance compared to a fresh battery. During the lifetime of a battery, its health will deteriorate gradually due to irreversible physical and chemical changes which take place with usage and with age until eventually the battery will no longer usable. The UPS calculates one value per week and plots it on the graph. The value are based on battery temperature, age, and the total amount of energy discharged from the battery that week. With use over time, this percentage will decrease until the *Battery Aged* alarm is generated is at 25%. It is recommended to replace the battery at or before this time.

To view the product, efficiency, and battery age information:

1. At the main menu, select the About icon, and press **Enter**.
2. Use the arrow buttons to move the cursor left/right and select a tab, then press **Enter** to display the information for the selected tab.

Figure 5.8 About Screen Tabs

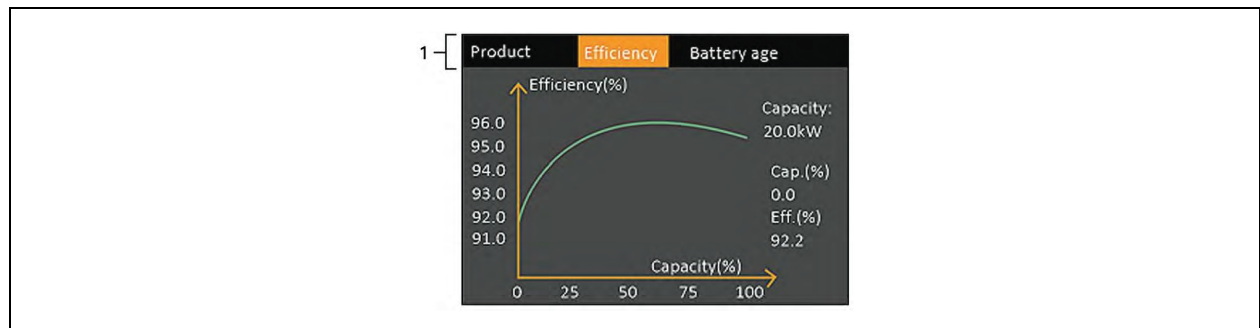

Item	Description
1	About screen tabs with Efficiency tab selected. NOTE: The tab shown in the figure is an example of the graph and does not represent the actual capacity values for your UPS model.

Product Information

Product Type

UPS model number.

Serial number

UPS serial number.

Time since startup

Elapsed time since start-up of the UPS.

Boot FW version

Version of MCU boot firmware on the monitor board.

Monitor FW version

Version of MCU application firmware on the monitor board.

DSP FW version

Version of DSP firmware on the UPS power module.

MAC address

Shows the MAC address of the RDU101 card. This is only shown when the RDU101 card is installed.

IPv4 address

Shows the IPv4 address of the RDU101 card. This is only shown when the RDU101 card is installed.

Subnet mask

Shows the subnet mask of the RDU101 card. This is only shown when the RDU101 card is installed.

Gateway address

Shows the gateway address of the RDU101 card. This is only shown when the RDU101 card is installed.

Efficiency Tab

Capacity

This shows the maximum capacity of your UPS model.

Cap. (%)

This shows the percentage of the maximum capacity your UPS is currently using.

Eff. (%)

This shows the efficiency the UPS is currently operating at based on the Cap. (%) value.

Battery Age

This page also displays the following values:

Battery recommended replacement date

This shows the date that it is recommend to replace the battery. It is 5 years from the time the battery was installed.

SOH (%)

This shows the current SOH percentage.

5.3 Editing Display and Operation Settings

You may adjust the display settings and UPS configuration via the LCD. The display and operation settings are password protected. The default password is 111111 (six ones).

NOTE: We recommend that you change the password to protect your system and equipment and record the new password and store it in an accessible location for later retrieval. See [Changing the Password](#) on the facing page.

To enter the password:

1. Press the up-arrow button to change the digit, then press the down-arrow button to move to the next digit.
2. Repeat to select each digit, and press **Enter** to submit the password.

Figure 5.9 Password Prompt

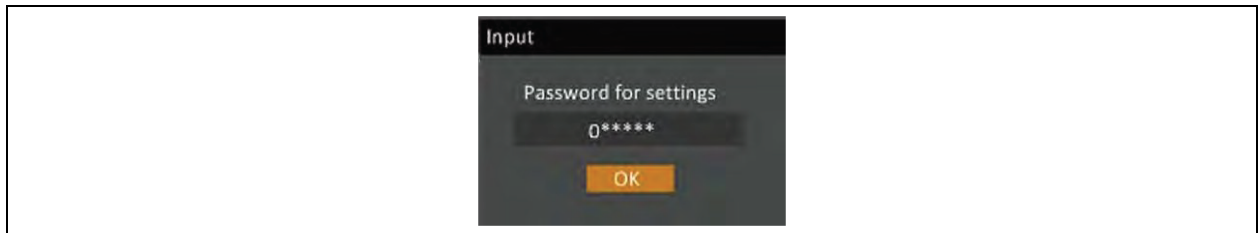

5.3.1 Setting Prompts

While using the operation and display panel, prompts display to alert you to specific conditions or require confirmation of commands or settings. **Table 5.5** on the facing page lists the prompts and their meaning.

Table 5.5 Display Prompts and Meanings

Prompt	Meaning
Cannot set this online, please shut down output	Appears when changing important output settings (output voltage, output frequency, output phase No.).
Incorrect password, please input again	Appears when the Settings password is input incorrectly.
Operation failed, condition is not met	Appears when attempting to execute an operation for which the required conditions are not met.
Password changed OK	Appears upon successful change of the Settings password.
Fail to change password, please try again	Appears when attempting to change the Settings password but the new and confirmation passwords do not match.
The time cannot be earlier than system time	Appears when attempting to set the time of Turn on delay or Turn off delay earlier than the current system time.
Turn on failed, condition is not met	Appears when proper conditions are not met for UPS power on. Applies when using the power button or when execute the command of Turn on/turn off/to Bypass on the LCD panel Control page).
Cannot set this on line, please unplug REPO	Appears when attempting to change the output phase number while the output is connected.

5.3.2 Changing the Password

The default password is 111111 (six ones). You must use the current password to change the password.

NOTE: We recommend that you change the password from the default to protect your system and equipment. Record the new password and store it in an accessible location for later retrieval.

1. At the main menu, select the Settings icon, and press **Enter**.
2. At the password prompt, use the up-arrow to select the first digit, press the down-arrow to move to the next digit, repeat for each digit, then press **Enter** to access the settings.
3. Use the arrow buttons to select the Monitor tab, then press **Enter**.
4. Use the down arrow to highlight *Change Settings Password*, press **Enter**, and re-enter the current password. The Input new password dialog opens, see **Figure 5.10** below.
5. Enter the new password, then confirm the new password.
6. A confirmation dialog opens to indicate a successful password change.
7. Press **ESC** to return to the settings or main men.

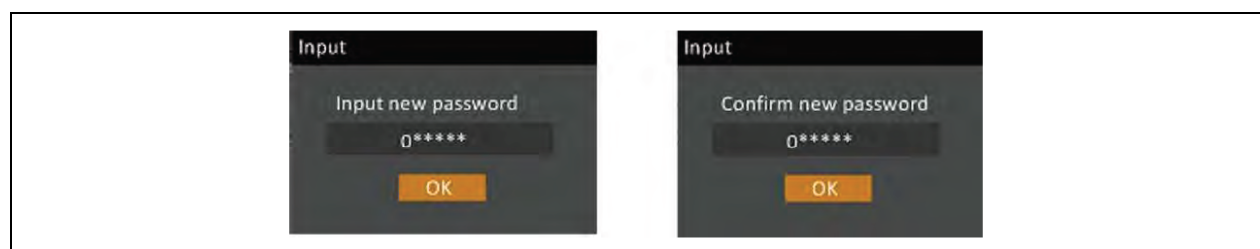
Figure 5.10 New and Confirm Password Dialogs

5.3.3 Selecting the Display Language

The LCD is multilingual. The available languages are English, French, Portuguese, Spanish, Chinese, German, Japanese, and Russian.

To change the language:

1. At the main menu, select the Settings icon, and press **Enter**.
2. At the password prompt, use the up-arrow to select the first digit, press the down-arrow to move to the next digit, repeat for each digit, then press **Enter** to access the settings.
3. Use the arrow buttons to select the Monitor tab, then press **Enter**.
4. Use the down arrow to highlight *Language*, then press **Enter**.
5. Use the up/down arrows to select the language, then press **Enter**.
6. All the LCD elements display in the selected language.

5.3.4 Setting the Date and Time

To adjust the date and time:

1. At the main menu, select the Settings icon, and press **Enter**.
2. At the password prompt, use the up-arrow to select the first digit, press the down-arrow to move to the next digit, repeat for each digit, then press **Enter** to access the settings.
3. Use the arrow buttons to select the Monitor tab, then press **Enter**.
4. Use the down arrow to highlight *Date or Time*, then press **Enter**.
5. Use the up/down arrows to select the date/time, then press **Enter** to confirm.
6. Use the down arrow to select the digit to change and the up arrow to select the correct digit. Repeat as needed to set each digit.

6 Maintenance



WARNING! Risk of electric shock. Can cause equipment damage, injury and death. A battery can present a risk of electrical shock and high short-circuit current.

Observe the following precautions when working on batteries:

- Remove watches, rings and other metal objects.
- Use tools with insulated handles.
- Wear rubber gloves and boots.
- Do not lay tools or metal parts on top of batteries.
- Disconnect charging source prior to connecting or disconnecting battery terminals.
- If the battery kit is damaged in any way or shows signs of leakage, contact your Vertiv representative immediately.
- Handle, transport, and recycle batteries in accordance with local regulations.
- Determine if the battery is inadvertently grounded. If it is inadvertently grounded, remove the source of the ground. Contact with any part of a grounded battery can result in electrical shock. The likelihood of such shock will be reduced if grounds are removed during installation and maintenance.

6.1 Replacing Batteries



WARNING! Risk of electric shock. Can cause injury or death. Disconnect all local and remote electric power supplies before working with the UPS. Ensure that the unit is shut down and power has been disconnected before beginning any maintenance.



WARNING! Risk of electric shock and explosion. Can cause equipment damage, injury and death. Do not dispose of the battery in a fire. The battery may explode. Do not open or damage the battery. Released electrolyte is toxic and is harmful to skin and eyes. If electrolyte comes into contact with the skin, wash the affected area immediately with plenty of clean water and get medical attention.



WARNING! Risk of electric shock. Can cause equipment damage, injury and death. A battery can present a risk of electrical shock and high short-circuit current.



WARNING! Risk of explosion. Can cause equipment damage, injury and death. A battery can explode if the battery is replaced by an incorrect type. Dispose of used batteries according to the instructions included with the battery-pack.

Read all safety cautions before proceeding. A trained user can replace the internal battery pack when the UPS is in a restricted access location (such as a rack or server closet). To obtain the appropriate replacement battery packs, refer to **Table 6.1** on the next page, and contact your local dealer or Vertiv representative.

Table 6.1 Replacement Battery-pack Model Numbers

UPS Model Number	Battery Pack Model Number	Quantity Required
GXT5-5000MVRT4UXLN	GXT5-144VBATKIT	1
GXT5-6000MVRT4UXLN	GXT5-144VBATKIT	
GXT5-8000MVRT6UXLN	GXT5-288VBATKIT	
GXT5-10KMVRT6UXLN	GXT5-288VBATKIT	
GXT5-15KMVRT11UXLN	GXT5-288VBATKIT	2
GXT5-20KMVRT11UXLN	GXT5-288VBATKIT	

To replace a battery pack:

NOTE: The internal battery pack is hot-swappable. However, you must exercise caution because; during this procedure, the load is unprotected from disturbances and power outages. Do not replace the battery while the UPS is operating in Battery Mode. This will result in a loss of output power and will drop the connected load.

1. Press the button on the left-front of the UPS front panel, and pull the panel open, then, loosen and remove the screw from the battery door, see **Figure 6.1** on the facing page.
2. Lay the battery door and screw aside for reassembly.
3. Grasp the battery handle, and pull out the battery pack, see **Figure 6.1** on the facing page.
4. Unpack the replacement battery pack, taking care not to damage the packaging to re-use when disposing of the old battery.
5. Compare the new and old battery pack to make sure they are the same type and model. If so, proceed with step 6. If they are different, stop and contact your Vertiv representative, or Technical Support, <https://www.vertiv.com/en-us/support/>.
6. Line-up and slowly push-in each replacement battery pack. The battery is fully inserted if the battery door fits flush against the UPS.
7. Re-attach the battery door with the screw and replace the front cover.
8. Activate the new battery packs using the operating/display panel.

NOTE: The display menus and functions are described in Operation and Display Panel on page 35.

9. From the main menu, select *Settings*, then the Monitoring tab and verify that the date and time are correct. If the date or time need correction, see [Setting the Date and Time](#) on page 56.
10. Select the *Battery tab*, use the arrows to select Replace Battery, and press **Enter**. The replaced battery packs are activated.
11. Use **ESC** to return to the main display.

Figure 6.1 Replacing the Battery Pack

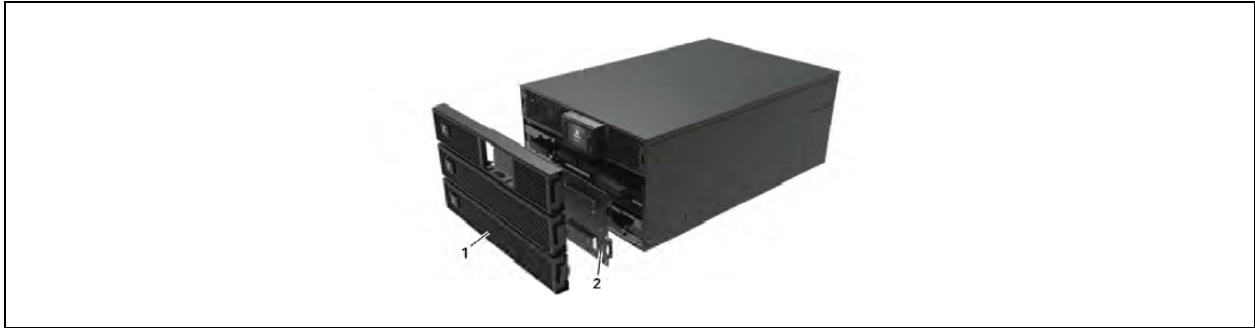

Item	Description
1	Front panel
2	Battery door

6.2 Charging Batteries

The batteries are valve-regulated, non-spillable, lead acid and should be kept charged to attain their design life. The UPS charges the batteries continuously when it is connected to the utility input power.

If the UPS will be stored for a long time, We recommend connecting the UPS to input power for at least 24 hours every 4 to 6 months to ensure full recharge of the batteries.

6.3 Checking UPS Operation

NOTE: Operation check procedures may interrupt power supply to the connected load.

We recommend checking the UPS operation once every 6 months. Ensure that output power loss to the connected load will not cause data loss or other errors before conducting the check.

1. Press the **Enter** button to check the indicators and display function.
2. Check for alarm or fault indicators on the operation/display panel.
3. Make sure that there are no audible or silenced alarms. Select the *Log*, and look at the current tab for alarm and fault history, see [Log Screen](#) on page 48.
4. Select the *Setting* menu, and look at the log for alarm and fault history.
5. Check the operating mode for Normal mode. If the UPS is operating in bypass mode, contact Vertiv Technical Support.
6. Check to see if batteries are discharging (operating in Battery mode) and utility power is normal. If so, contact Vertiv Technical Support.

6.4 Cleaning the UPS



WARNING! Risk of electric shock. Can cause injury or death. Disconnect all local and remote electric power supplies before working with the UPS. Ensure that the unit is shut down and power has been disconnected before beginning any maintenance.

The UPS requires no internal cleaning. If the outside of the UPS becomes dusty, wipe with a dry cloth. Do not use liquid or aerosol cleaners. Do not insert any objects into the ventilation holes or other openings in the UPS.

6.5 Replacing the UPS using Maintenance Bypass

Use the following procedures to replace the UPS from the power distribution box.



WARNING! Risk of electric shock. Can cause injury or death. Disconnect all local and remote electric power supplies before working with the UPS. Ensure that the unit is shut down and power has been disconnected before beginning any maintenance.

NOTE: Do not operate the UPS with the POD removed. To shut off all power to the POD and to the load, utility input power must be disconnected.

1. Transfer the connected equipment to bypass mode.
 - a. Loosen the upper captive screw over the maintenance bypass breaker, see **Figure 6.2** below.
 - b. Lift the maintenance bypass breaker cover up and tighten the lower captive screw.
2. Confirm that the UPS is operating in bypass mode. If not, then manually transfer the connected equipment to bypass as follows:
 - a. Press and hold the **Power** button for 2 seconds.
 - b. Select Turn to bypass and press **Enter**.

NOTE: The load is unprotected from disturbances in the power supply while the UPS is on bypass.

3. Turn the maintenance bypass breaker *On*.
4. Wait 1 minute if the UPS is working on battery mode, then confirm that the UPS is turned off.
5. Turn the output and input breakers *Off*.
6. On 5 kVA models, loosen the remaining screws until the POD releases the UPS.
7. Remove the UPS from the power distribution box and set it aside.

NOTE: The captive screws and maintenance bypass breaker cover is similar for all models. Figure 6.2 below, shows an example on the 5 kVA/6 kVA model.

NOTE: Secure only one captive screw on the maintenance bypass breaker cover; do not attempt to force the second screw.

Figure 6.2 Maintenance Bypass Breaker Cover and Captive Screws



Item	Description
1	Captive screws for POD
2	Maintenance bypass breaker

8. Align the tabs on the bottom of the replacement POD with the slots on the UPS, and press the POD onto the UPS.
9. Secure the POD to the UPS using two screws.
10. Make sure the maintenance bypass switch is in the open, *OFF*, position and that the guard is secured in place.

NOTE: The maintenance bypass breaker interlock bracket must be installed behind the captive screw, and the screw must be tightened for the UPS to operate in Normal mode.

11. Turn *ON* the input breaker on the rear of the UPS and leave the output breakers *OFF*. The UPS will begin to startup.
12. Confirm that the UPS is operating in bypass mode. If not, then manually transfer the connected equipment to bypass as follows:
 - a. Press and hold the **Power** button for two seconds.
 - b. Select *Turn to bypass* and press **Enter**.
13. Turn the output breakers *ON*.
14. Power on the UPS by pressing and holding the power button on the operation and display panel until the confirmation dialog appears. Use the *Up/Down* arrows to select *YES*, then press **Enter**.

6.6 Firmware Updates

Firmware updates are available via the [Vertiv website](#). Firmware update instructions are provided with the firmware download.

This page intentionally left blank

7 Troubleshooting

This section indicates various UPS symptoms you may encounter and provides a troubleshooting guide in the event the UPS develops a problem. Use the following information to determine whether external factors caused the problem and how to remedy the situation.

7.1 Symptoms that Require Troubleshooting

The following symptoms indicate the UPS is malfunctioning:

- The relative indicators illuminate, indicating the UPS has detected a problem.
- An alarm buzzer sounds, alerting the user that the UPS requires attention.

7.2 Audible Alarm (Buzzer)

An audible alarm accompanies various events during UPS operations. **Table 7.1** below, describes the sounds and their meaning. To silence an alarm, see [Silencing the Audible Alarm](#) on page 33.

Table 7.1 Audible Alarm Description

Sound	Indicates
Continuous beep	Generated when a UPS fault appears, such as a fuse or hardware failure.
One beep every 0.5 second	Generated when a UPS critical alarm appears, such as on inverter overload.
One beep every 1 second	Generated when a UPS critical alarm appears, such as on battery low voltage.
One beep every 3.3 seconds	Generated when a UPS general alarm appears.

NOTE: When an alarm is indicated, an alarm message is logged. **Table 5.4** on page 52, describes the alarm messages you may see. When a fault is indicated, front panel display list the fault, which are described in **Table 7.2** on the next page.

7.2.1 Faults

When the fault indicator is illuminated, the LCD displays the fault. The faults are described in **Table 7.2** on the next page.

Figure 7.1 LCD Display—Fault Indicator



Table 7.2 Description of Displayed Faults

Displayed Fault	Cause	Corrective Steps
Battery test fail	The battery is bad or weak.	Contact technical support.
Rectifier fault	A rectifier failure occurred.	Contact technical support.
Inverter overload, Bypass overcurrent	The UPS is overloaded, Bypass is over current.	Reduce the load and contact technical support.
Inverter fault	The inverter is faulty.	Contact technical support.
Battery aged	The battery is bad or weak.	Replace the battery.
Output short	The output connection is short-circuited.	Shut-down the equipment and contact technical support.
DC bus fail	The DC bus is faulty.	Contact technical support.
System overtemp	Over-temperature condition in the UPS. The UPS will transfer to bypass mode.	Reduce the load and contact technical support.
Charger fault	The charger is faulty.	Contact technical support.
Fan fault	At least one fan is faulty.	Contact technical support.
DC/DC fault	A DC-DC charger failure occurred.	Contact technical support.

7.3 Troubleshooting UPS Issues

In the event of an issue with the UPS, refer to **Table 7.3** below, to determine the cause and solution. If the fault persists, contact Vertiv Technical Support. Visit the Vertiv™ Liebert® GXT5 product page at www.vertiv.com for contact information.

When reporting a UPS issue to Vertiv, include the UPS model and serial number. These are located in several places for your ease of location:

- On the top panel (rack mount orientation)
- The left side (tower orientation)
- The rear panel
- On the front of the unit behind the front plastic bezel
- On the LCD select Main Menu > About

Table 7.3 Troubleshooting

Problem	Cause	Solution
UPS fails to start	UPS is short-circuited or overloaded	Ensure UPS is Off. Disconnect all loads and ensure nothing is lodged in output receptacles. Ensure loads are not defective or shorted internally.
	Batteries are not charged enough or not connected	Check to ensure the internal battery is connected. If it is not, make the connection and try to start the unit. If the battery is connected, leave the UPS connected to input power for 24 hours to recharge batteries, then try to start the unit.
UPS has reduced battery backup time	Batteries are not fully charged	Keep UPS plugged in continuously at least 24 hours to recharge batteries.
	UPS is overloaded	Check load level indicator and reduce the load on the UPS.
	Batteries may not be able to hold a full charge due to age	Replace batteries. Contact your Vertiv representative or Vertiv Technical Support for replacement battery kit.

8 Specification

Table 8.1 UPS Specifications, 5 kVA to 10 kVA Models

Model GXT5	5000MVRT4UXLN	6000MVRT4UXLN	8000MVRT6UXLN	10KMVRT6UXLN	15KMVR-T1UXLN	20KMVR-T1UXLN
Rating	5000VA/5000W	6000VA/6000W	8000 VA/8000 W	10000VA/10000W	15000VA/15000W	20000VA/20000W
Dimensions, D×W×H, in. (mm)						
Unit	16.9 x 25.6 x 6.8 (430 x 650 x 173)		16.9 x 25.6 x 10.2 (430 x 650 x 261)		16.9 x 26.7 x 18.9 (430 x 680 x 482)	
Shipping	35 x 25.2 x 29.1 (890 x 640 x 740)		35 x 25.2 x 38.6 (890 x 640 x 980)		27.1 x 48.0 x 46.0 (690 x 1220 x 1169)	
Weight, lb.(kg)						
Unit	125.6 (57)		224.8 (102)		396.6 (179.9)	
Shipping	189.6 (86)		295.4 (134)		518.8 (231.0)	
Input AC						
Operating Frequency, Nom.	50 or 60 Hz (factory-default is 60 Hz)					
Factory default VAC	120/208 VAC at 120 degrees					
User Configurable	100/173V, 100/200, 110/190.5, 110/220, 115/199, 115/199, 115/230, 120/208, 120/240, 125/216.5, 125/250					
Allowable Input Phase Angle	120, 180, 240 degrees, auto-sensing on application of alternating current. (Restrictions for L-N voltages other than 120 VAC).					
Input frequency without battery operation	40-70 Hz					
Input Power connection	Hard-wired terminal terminal block 3W+G (L1-L2-N-G)					
L1-N, L2-N, Maximum Allowable VAC	150 VAC					
Output AC						
Factory-default VAC	120/208 VAC at 120 degrees					
L1-L2 Factory-default Output Phase Angle	120 degrees					

Table 8.1 UPS Specifications, 5 kVA to 10 kVA Models (continued)

Model GXT5	5000MVRT4UXLN	6000MVRT4UXLN	8000MVRT6UXLN	10KMVRT6UXLN	15KMVR-T11UXLN	20KMVR-T11UXLN
Rating	5000VA/5000W	6000VA/6000W	8000 VA/8000 W	10000VA/10000W	15000VA/15000W	20000VA/20000W
Allowable Output Phase Angle	120, 180, 240 degrees, auto-sensing on initial application of input AC					
Factory default L1-N, L2-N VAC	120 VAC nominal					
L1-N, L-2N, Operating Load Range	105% to 125% for 5 minutes 125% to 150% for 60 seconds >150% (impact load) minimum 200 ms					
Bypass Protection Limits						
Re-enable Bypass Operation	If input voltage returns to within $\pm 10\%$ nominal output voltage.					
Disable Bypass Operation	When the input frequency prevents synchronous operation.					
Battery Parameters						
Type	Valve-regulated, non- spillable, lead acid					
Quantity x Voltage x Rating	12 x 12V x 9.0AH	24 x 12V x 9.0AH	48 x 12V x 9.0AH			
Back-up time	See Battery Run Times on page 69.					
Recharge time	5 hours to 90% capacity after full-discharge into 100% load.					
Charger Current, A	1.8 A (default), maximum 5A					
Environment						
Operating Temperature, °F (°C)	32 to 104 (0 to 40) (no derating)					
Extended Operating Temperature (derated), °F (°C)	32 to 122 (0 to 50) output derated by 1% per 1 °C above 40°C					
Storage Temperature, °F (°C)	5 to 122 (-15 to 50)					
Relative Humidity	0 – 95% non-condensing					

Table 8.1 UPS Specifications, 5 kVA to 10 kVA Models (continued)

Model GXT5	5000MVRT4UXLN	6000MVRT4UXLN	8000MVRT6UXLN	10KMVRT6UXLN	15KMVR-T11UXLN	20KMVR-T11UXLN
Rating	5000VA/5000W	6000VA/6000W	8000 VA/8000 W	10000VA/10000W	15000VA/15000W	20000VA/20000W
Operating Elevation	Up to 10,000 ft (3,000 m) at 77°F (25°C) without derating					
Audible Noise	<50 dBA, at 3.2 ft (1 m) from the front and sides, <55 dBA, at 3.2 ft (1 m) from rear				<58 dBA, at 3.2 ft (1 m) from the front and sides	
Agency						
Safety	UL1778, c-UL listed					
RFI/EMI	FCC Part 15 (Class A)					
EMC	IEEE/ANSI C62.41 Category B					
Surge Immunity	IEEE/ANSI C62.41 Category B					
Transportation	ISTA Procedure 1A					

Table 8.2 POD Specifications for 5 kVA to 6 kVA Models

Model PD5	HDWR-MBS	001	002	003	004	005	006	007
Dimensions, D×W×H, in. (mm)								
Unit	5.2 x 15.5 x 3.5 (132 x 394 x 89)							
Shipping	9.5 x 20.7 x 9.1 (560 x 250 x 200)							
Weight, lb.(kg)								
Unit	6 (2.7)	8.8 (4.0)	8.6 (3.9)	9.9 (4.5)	10.6 (4.8)	9.5 (4.3)		
Shipping	8.2 (3.7)	11 (5)	10.8 (4.9)	12.1 (5.5)	12.8 (5.8)	11.7 (5.3)		
Electrical Specifications								
Rating when installed on 5 kVA	Factory default	5000VA/4500W						
Rating when installed on 6 kVA	Factory default	6000VA/5100W						
Input power connection	Hard-wired terminal block 3W + G (L-L-N-G)	(1) L14-30P on a 10.5 ft (3.2 m) cord (1)						
Output power connection	Hard-wired terminal block 3W + G (L-L-N-G)	(4) 5-20R (1) L14-30R (1) L6-30R	(2) 5-20R (2) L6-20R	(4) 5-20R (2) L6-30R	(4) L5-20R (2) L5-30R	(4) L5-20R (2) L6-30R	(4) L6-20R	(2) L5-20R (2) L6-20R

Table 8.3 POD Specifications for 8 kVA to 20 kVA Models

Model PD5-	101	102	103	104	105	106	107	108	109
Dimensions, D×W×H, in. (mm)									
Unit	7.4 x 5.7 (188 x 145)								
Shipping	11.9 x 20.6 x 8.7 (302 x 522 x 220)								
Weight, lb.(kg)									
Unit	4.4 (2)	6.6 (3)			4.4 (2)	6.6 (3)			
Shipping	6.6 (3)	8.8 (4)			6.6 (3)	8.8 (4)			
Electrical Specifications									
Amp Rating	2 pole 60 A input breaker								
Input power connection	Custom Connector 3W+G (L1-L2-N-G) to UPS								
Output power connection	(2) L6-30R (8) 5-20R	(4) L6-20R (4) 5-20R	(4) 5-20R (4) L6-30R	(4) 5-20R (2) L6-30R (2) L6-20R	(4) 5-20R (2) L5-30R (2) L5-20R	(4) L6-20R (4) L5-20R	(4) L5-20R (4) 5-15/20R	(2) L6-20R (2) L6-20R	(2) L14-30R

Table 8.4 Additional POD Specifications for 8 kVA to 20 kVA Models

Model PD2-	200	201	202	204
Dimensions, D×W×H, in. (mm)				
Unit	7.4 x 5.7 (188 x 145)			
Shipping	11.9 x 20.6 x 8.7 (302 x 522 x 220)			
Weight, lb.(kg)				
Unit	6.6 (3)	4.4 (2)		6.6 (3)
Shipping	15 (6.8)	6.6 (3)		15 (6.8)
Electrical Specifications				
Amp Rating	2 pole 60 A input breaker			
Input power connection	Custom Connector 3W+G (L1-L2-N-G) to UPS			
Output power connection	(4) IEC320-C19 (4) IEC320-C13	(2) IEC320-C19 (8) IEC320-C13	(12) IEC320-C13	(2) IEC309-32A (4) IEC320-C13

Table 8.5 External Battery Cabinet Specifications

Model Number	GXT5-EBC144VRT2U	GXT5-EBC288VRT4U	GXT5-EBC288VRT8U
Used W/UPS Model	5 – 6 KVA Models	8 – 10 KVA Models	15 – 20 KVA Models
Dimensions, D×W×H, in. (mm)			
Unit (with bezel)	17.5 x 26.5 x 3.5 (430 x 650 x 85)	17.5 x 26.5 x 7.1 (430 x 650 x 173)	16.9 x 26.7 x 13.6 (430 x 680 x 346)
Shipping	35.5 x 25.7 x 19.8 (845 x 630 x 485)	35.5 x 25.7 x 23.2 (845 x 630 x 570)	26.4 x 34.6 x 34.1 (670 x 880 x 867)
Weight, lb.(Kg)			
Unit	81.6 (37)	189.6 (86)	361.6 (164)
Shipping	123.5	233.7	418.9 (190)
Battery			
Type	Valve-regulated, non-spillable, lead acid		
Qty × Voltage	12 x 12V	24 x 12V	48 x 12V
Backup time	See Battery Run Times below.		
Environmental Requirements			
Operating Temperature, °F (°C)	32 to 104 (0 to 40)		
Storage Temperature, °F (°C)	5 to 122 (–15 to 50)		
Relative Humidity	0% to 95%, non-condensing		
Operating Elevation	Up to 10,000 ft (3,000 m) at 104 °F (40 °C)		
Agency			
Safety	UL1778 4th Edition and CSA 22.2 No. 107.3		
RFI/EMI	FCC Part 15 Class A		
Transportation	ISTA Procedure 1A		

8.1 Battery Run Times

NOTE: Run times in this table are approximate. Times are based on new, fully charged, standard battery modules at a temperature of 77 °F (25 °C) with 100% resistive UPS loading. Run times listed above can vary by ±5% due to manufacturing variances of the individual batteries.

Table 8.6 Battery Run Time in Minutes, GXT5-5000MVRT4UXLN

Load			Internal Battery Only	Number of External Battery Cabinets									
				1	2	3	4	5	6	7	8	9	10
%	VA	W	Minutes										
10	500	500	87.0	195.0	311.0	427.5	543.5	660.0	776.0	892.5	1009.0	1125.0	1241.5
20	1000	1000	41.5	94.0	149.0	211.0	273.5	335.5	397.5	460.0	522.0	584.5	646.5
30	1500	1500	24.5	61.0	97.0	133.0	175.0	218.0	260.5	303.0	345.5	388.0	430.5

Table 8.6 Battery Run Time in Minutes, GXT5-5000MVRT4UXLN (continued)

Load			Internal Battery Only	Number of External Battery Cabinets									
				1	2	3	4	5	6	7	8	9	10
40	2000	2000	16.5	44.0	71.5	99.0	126.5	157.5	190.0	222.5	255.5	288.0	320.5
50	2500	2500	12.5	33.0	55.5	78.0	100.0	122.5	146.5	173.0	199.0	225.5	252.0
60	3000	3000	9.5	25.5	44.5	63.5	82.0	100.5	119.0	138.5	160.5	182.5	204.5
70	3500	3500	7.5	20.5	36.5	53.0	69.0	85.0	101.0	117.0	133.0	151.5	170.5
80	4000	4000	6.5	17.0	30.5	45.0	59.0	73.0	87.0	101.0	115.0	129.0	145.0
90	4500	4500	5.0	14.5	26.0	38.5	51.5	64.0	76.5	89.0	101.5	114.0	126.5
100	5000	5000	4.5	12.5	22.5	33.5	45.0	56.5	68.0	79.0	90.0	101.5	113.0

Table 8.7 Battery Run Time in Minutes, GXT5-6000MVRT4UXLN

Load			Internal Battery Only	Number of External Battery Cabinets									
				1	2	3	4	5	6	7	8	9	10
%	VA	W	Minutes										
10	600	600	72.5	160.0	258.5	357.5	456.5	555.0	654.0	752.5	851.5	950.5	1049.0
20	1200	1200	33.0	77.5	122.0	172.0	224.5	277.0	329.5	382.0	434.5	487.0	539.5
30	1800	1800	19.0	49.5	80.0	110.0	142.0	178.0	213.5	249.5	285.5	321.5	357.5
40	2400	2400	13.0	35.0	58.5	81.5	104.5	128.0	154.0	181.5	209.0	236.5	263.5
50	3000	3000	9.5	25.5	44.5	63.5	82.0	100.5	119.0	138.5	160.5	182.5	204.5
60	3600	3600	7.5	20.0	35.5	51.0	66.5	82.0	98.0	113.5	129.0	146.5	165.0
70	4200	4200	6.0	16.0	28.5	42.0	56.0	69.0	82.5	96.0	109.0	122.5	136.5
80	4800	4800	4.5	13.5	24.0	35.5	47.5	59.5	71.0	82.5	94.5	106.0	118.0
90	5400	5400	4.0	11.5	20.0	30.5	41.0	51.5	62.0	72.5	83.0	93.5	104.0
100	6000	6000	3.5	9.5	17.5	26.0	35.5	45.5	55.0	64.5	73.5	83.0	92.5

Table 8.8 Battery Run Time in Minutes, GXT5-8000MVRT6UXLN

Load			Internal Battery Only	Number of External Battery Cabinets									
				1	2	3	4	5	6	7	8	9	10
%	VA	W	Minutes										
10	800	800	118	267.5	420	572.5	725	878	1030.5	1183	1335.5	1488	1640.5
20	1600	1600	56.5	124.5	203	283	363	443.5	523.5	603.5	684	764	844
30	2400	2400	35	81.5	128	181.5	236.5	291	346	400.5	455.5	510	565
40	3200	3200	23.5	59	93.5	128.5	169	210.5	251.5	293	334.5	375.5	417
50	4000	4000	17	45	73	101	129	161.5	195	228	261	294.5	327.5

Table 8.8 Battery Run Time in Minutes, GXT5-8000MVRT6UXLN (continued)

Load			Internal Battery Only	Number of External Battery Cabinets									
				1	2	3	4	5	6	7	8	9	10
60	4800	4800	13.5	35.5	59.5	82.5	106	129.5	156.5	184.5	212	240	267.5
70	5600	5600	10.5	29	49.5	69.5	89.5	110	130	153	177	201	225
80	6400	6400	9	24	42	59.5	77.5	95	112.5	130.5	150.5	171.5	192.5
90	7200	7200	7.5	20.5	36	52	67.5	83.5	99	115	130.5	148.5	167.5
100	8000	8000	6.5	17.5	31	45.5	60	74	88	102.5	116.5	131	147

Table 8.9 Battery Run Time in Minutes, GXT5-10KMVRT6UXLN

Load			Internal Battery Only	Number of External Battery Cabinets									
				1	2	3	4	5	6	7	8	9	10
%	VA	W	Minutes										
10	1000	1000	94.0	211.0	335.5	460.0	584.5	708.5	833.0	957.5	1082.0	1206.0	1330.5
20	2000	2000	44.0	99.0	157.5	222.5	288.0	353.0	418.0	483.0	548.0	613.5	678.5
30	3000	3000	25.5	63.5	100.5	138.5	182.5	226.5	270.5	314.5	358.5	402.5	446.5
40	4000	4000	17.0	45.0	73.0	101.0	129.0	161.5	195.0	228.0	261.0	294.5	327.5
50	5000	5000	12.5	33.5	56.5	79.0	101.5	124.0	149.0	175.5	202.5	229.0	255.5
60	6000	6000	9.5	26.0	45.5	64.5	83.0	102.0	121.0	140.5	163.0	185.5	207.5
70	7000	7000	7.5	21.0	37.0	54.0	70.0	86.0	102.0	118.5	135.0	154.0	173.0
80	8000	8000	6.5	17.5	31.0	45.5	60.0	74.0	88.0	102.5	116.5	131.0	147.0
90	9000	9000	5.5	15.0	26.5	39.5	52.0	65.0	77.5	90.0	102.5	115.5	128.0
100	10000	10000	4.5	13.0	23.0	34.5	46.0	57.5	69.0	80.5	91.5	103.0	114.5

NOTE: EBCs must be connected in pairs to these models. See Figure 3.4 on page 21 for details.

Table 8.10 Battery Run Time in Minutes, GXT5-15KMVRT11UXLN

Load			Internal Battery Only	Number of External Battery Cabinets									
				1	2	3	4	5	6	7	8	9	10
%	VA	W	Minutes										
10	1500	1500	133.0	303.0	473.0	643.5	814.0	984.0	1154.5	1324.5	1495.0	1665.0	1835.5
20	3000	3000	63.5	138.5	226.5	314.5	402.5	491.0	579.0	667.0	755.0	843.0	931.0
30	4500	4500	38.5	89.0	140.0	199.0	258.0	317.5	376.5	435.5	494.5	554.0	613.0
40	6000	6000	26.0	64.5	102.0	140.5	185.5	230.0	274.5	319.0	363.5	408.0	453.0
50	7500	7500	19.0	49.5	79.5	110.0	141.5	177.0	213.0	249.0	284.5	320.5	356.0
60	9000	9000	15.0	39.5	65.0	90.0	115.5	142.0	172.0	202.0	232.0	262.0	291.5

Table 8.10 Battery Run Time in Minutes, GXT5-15KMVRT11UXLN (continued)

Load			Internal Battery Only	Number of External Battery Cabinets									
				1	2	3	4	5	6	7	8	9	10
70	10500	10500	12.0	32.0	54.5	76.0	98.0	120.0	143.0	169.0	194.5	220.5	246.5
80	12000	12000	10.0	27.0	46.5	65.5	85.0	104.0	123.5	144.0	167.0	189.5	212.5
90	13500	13500	8.5	23.0	40.0	57.5	74.5	91.5	108.5	125.5	144.0	164.5	184.5
100	15000	15000	7.0	19.5	34.5	50.5	66.0	81.0	96.5	112.0	127.5	144.5	162.5

Table 8.11 Battery Run Time in Minutes, GXT5-20KMVRT11UXLN

Load			Internal Battery Only	Number of External Battery Cabinets									
				1	2	3	4	5	6	7	8	9	10
%	VA	W	Minutes										
10	2000	2000	99.0	222.5	353.0	483.0	613.5	743.5	873.5	1004.0	1134.0	1264.5	1394.5
20	4000	4000	45.0	101.0	161.5	228.0	294.5	361.0	427.0	493.5	560.0	626.5	693.0
30	6000	6000	26.0	64.5	102.0	140.5	185.5	230.0	274.5	319.0	363.5	408.0	453.0
40	8000	8000	17.5	45.5	74.0	102.5	131.0	164.0	197.5	231.0	265.0	298.5	332.0
50	10000	10000	13.0	34.5	57.5	80.5	103.0	126.0	151.5	179.0	206.0	233.0	260.0
60	12000	12000	10.0	27.0	46.5	65.5	85.0	104.0	123.5	144.0	167.0	189.5	212.5
70	14000	14000	8.0	21.5	38.0	55.0	71.0	87.5	104.0	120.5	137.5	157.0	176.5
80	16000	16000	6.5	18.0	32.0	46.5	61.0	75.5	89.5	104.0	118.5	133.0	150.0
90	18000	18000	5.5	15.0	27.0	40.0	53.0	66.0	78.5	91.5	104.0	117.0	130.0
100	20000	20000	4.5	13.0	23.0	34.5	46.5	58.0	69.5	81.0	92.5	104.5	116.0

Appendices

Appendix A: Technical Support and Contacts

A.1 Technical Support/Service in the United States

Vertiv Group Corporation

24x7 dispatch of technicians for all products.

1-800-543-2378

Liebert® Thermal Management Products

1-800-543-2378

Liebert® Channel Products

1-800-222-5877

Liebert® AC and DC Power Products

1-800-543-2378

A.2 Locations

United States

Vertiv Headquarters

505 N Cleveland Ave

Westerville, OH 43082

Europe

Via Leonardo Da Vinci 8 Zona Industriale Tognana

35028 Piove Di Sacco (PD) Italy

Asia

7/F, Dah Sing Financial Centre

3108 Gloucester Road, Wanchai

Hong Kong

This page intentionally left blank

Appendix B: Open Source Software Legal Notices

The Vertiv™ Liebert® GXT5 product links the FreeRTOS software with Vertiv Group Corporation's proprietary modules that communicate with the FreeRTOS software solely through the FreeRTOS API interface. This use is an exception to the FOSS GPLv2 license. The user is free to redistribute the FreeRTOS software and/or modify it under the terms of the GNU General Public License as published by the Free Software Foundation. A copy of the GNU General Public License is located at www.gnu.org/licenses/old-licenses/gpl-2.0.html. A copy of the exception is located at <https://spdx.org/licenses/freertos-exception-2.0.html>. For a period of three (3) years after purchasing the Liebert® GXT5 product, the purchaser has the right to obtain a copy of the FreeRTOS software that is incorporated in the Liebert® GXT5 product. The purchaser can contact Vertiv Technical Support and request the software.

This page intentionally left blank

Connect with Vertiv on Social Media



<https://www.facebook.com/vertiv/>



<https://www.instagram.com/vertiv/>



<https://www.linkedin.com/company/vertiv/>



<https://www.twitter.com/Vertiv/>



Vertiv.com | Vertiv Headquarters, 505 N Cleveland Ave, Westerville, OH 43082 USA

©2024 Vertiv Group Corp. All rights reserved. Vertiv™ and the Vertiv logo are trademarks or registered trademarks of Vertiv Group Corp. All other names and logos referred to are trade names, trademarks or registered trademarks of their respective owners. While every precaution has been taken to ensure accuracy and completeness here, Vertiv Group Corp. assumes no responsibility, and disclaims all liability, for damages resulting from use of this information or for any errors or omissions.

SL-70524_REV5_05-24