



PowerUPS 9000 1250 kVA Modular UPS (UL)

User Manual

250 kVA to 1250 kVA, 480 V, 3-Wire, 50/60 Hz

The information contained in this document is subject to change without notice and may not be suitable for all applications. While every precaution has been taken to ensure the accuracy and completeness of this document, Vertiv assumes no responsibility and disclaims all liability for damages result from use of this information or for any errors or omissions.

Refer to local regulations and building codes relating to the application, installation, and operation of this product. The consulting engineer, installer, and/or end user is responsible for compliance with all applicable laws and regulations relation to the application, installation, and operation of this product.

The products covered by this instruction manual are manufactured and/or sold by Vertiv. This document is the property of Vertiv and contains confidential and proprietary information owned by Vertiv. Any copying, use, or disclosure of it without the written permission of Vertiv is strictly prohibited.

Names of companies and products are trademarks or registered trademarks of the respective companies. Any questions regarding usage of trademark names should be directed to the original manufacturer.

Technical Support Site

If you encounter any installation or operational issues with your product, check the pertinent section of this manual to see if the issue can be resolved by following outlined procedures.

Visit <https://www.vertiv.com/en-us/support/> for additional assistance.

TABLE OF CONTENTS

1 Important Safety Instructions	1
1.1 Glossary of Symbols	5
2 Overview	7
2.1 Introduction	7
2.2 Features	7
2.3 Control and Display Panel	7
2.4 Operation Modes	8
2.4.1 Normal Mode	8
2.4.2 Battery Mode	9
2.4.3 Automatic restart mode	9
2.4.4 Bypass Mode	10
2.4.5 ECO mode	10
2.4.6 Frequency Converter Mode	11
2.4.7 Dynamic online mode	11
2.4.8 Parallel Mode (system expansion)	12
2.4.9 LBS mode	12
2.5 Battery Management System	12
2.5.1 Normal Function	12
2.5.2 Advanced functions	13
2.5.3 Battery Temperature Compensation	14
2.6 Battery Protection	14
2.6.1 Battery Low Pre-warning	14
2.6.2 EOD Protection	14
2.6.3 Battery Circuit Breaker Alarm	14
2.7 Parallel System and LBS System	14
2.7.1 Parallel System	14
2.7.2 Parallel System Requirements	14
2.7.3 LBS System	15
3 Mechanical Installation	17
3.1 Precautions	17
3.2 Transportation	17
3.3 Tools	18
3.4 Unpacking	19
3.5 Pre-installation Inspection	21
3.6 Environmental Requirement	22
3.6.1 UPS Location Selection	22
3.6.2 Battery Location Selection	22
3.6.3 Storage	22

- 3.7 Mechanical Requirement 23
 - 3.7.1 Composition 23
 - 3.7.2 Moving the Cabinet 23
 - 3.7.3 Clearance 23
 - 3.7.4 Cable Access 24
- 3.8 Installation 24
- 3.9 Module Components Introduction 25
 - 3.9.1 Power Module Components 25
 - 3.9.2 Bypass Module Component 27
 - 3.9.3 Bypass Control Module Component 27
 - 3.9.4 Control Module Component 28
- 3.10 Installation Drawings 29
- 4 Electrical Installation 31**
- 4.1 Power Cable Wiring 31
 - 4.1.1 System Configuration 31
 - 4.1.2 Maximum Steady State AC and DC Currents 31
 - 4.1.3 Recommended Cross Section Area of UPS Cable 32
 - 4.1.4 Recommended Breaker of UPS OPD 36
 - 4.1.5 General Information 36
 - 4.1.6 Power Cable Connecting Terminal 37
 - 4.1.7 Protective Ground 37
 - 4.1.8 External Protective Devices 37
 - 4.1.9 Power Cable Connection Steps 38
- 4.2 Wiring of Signal Cable 45
 - 4.2.1 Overview 45
 - 4.2.2 Dry Contact Port X6 J3 45
 - 4.2.3 Output Dry Contact X7 J1 (Option) 48
 - 4.2.4 Output Dry Contact X7 J2 (Option) 49
 - 4.2.5 Output Dry Contact X7 J3 (Option) 50
 - 4.2.6 Remote Emergency Power Off Port 51
 - 4.2.7 Parallel and LBS Communication Ports 52
 - 4.2.8 Vertiv™ Liebert® IntelliSlot™ Port 52
 - 4.2.9 Signal Cable Connection Steps 53
- 5 Operator Control and Display Panel 57**
- 5.1 Introduction 57
- 5.2 Navigating through the PowerUPS 9000 1250 kVA Modular UPS Touchscreen 57
 - 5.2.1 Vertiv™ PowerUPS 9000 1250 kVA Modular UPS Touchscreen Control Panel Components 58
- 5.3 Operation 59
 - 5.3.1 Login 59
 - 5.3.2 Operator Controls 61

5.4 Viewing UPS Status	66
5.4.1 Status Bar Component	66
5.4.2 Viewing UPS Data with the Status Gauge	67
5.4.3 Viewing UPS Data with the Status Panel	68
5.4.4 Logs Alarms and Events	71
6 Single UPS Operation	73
6.1 Introduction	73
6.2 UPS Start-up Procedures	73
6.2.1 Start-up Procedures in Normal Mode	73
6.2.2 Start-up Procedures in Economic Mode	77
6.3 Procedures for Transfer Between Operation Modes	78
6.3.1 Transfer from Normal Mode to Battery Mode	78
6.3.2 Transfer from Normal Mode to Bypass Mode	78
6.3.3 Transfer from Bypass Mode to Normal Mode	79
6.4 Battery Test Procedures	80
6.5 UPS Shutdown Procedures	82
6.5.1 Procedures to Completely Power Down the UPS	82
6.6 Emergency Power Off Procedures	83
6.7 UPS Reset Procedures after Emergency Power Off	83
6.8 Automatic Restart	83
7 Battery	85
7.1 Introduction	85
7.2 Safety	85
7.2.1 Safety Precautions	85
7.3 UPS Battery	86
7.4 Precautions for Installation Design	87
7.5 Battery Installation Environment and Number of Batteries	87
7.5.1 Installation Environment	87
7.6 Battery Protection	88
7.7 Battery Installation and Connection	89
7.8 Other External Battery	89
7.8.1 VRLA Battery Cabinet	89
7.8.2 Ni-Cd battery cabinet	89
7.8.3 Lithium Ion Battery Cabinet	89
7.9 Battery Ground Fault Detector	90
7.10 Power Supply Units for Battery Interface Board	90
8 Parallel System and Load Bus Synchronization System	93
8.1 General	93
8.2 System Installation Procedures	93
8.2.1 Preliminary Checks	93

- 8.2.2 Cabinet Installation 93
- 8.2.3 External Protective Device 94
- 8.2.4 Power Cable 95
- 8.2.5 Parallel Cable 95
- 8.2.6 Remote Emergency Power Off 96
- 8.3 Operation Procedures for Parallel System 97
 - 8.3.1 Start-up Procedures in Normal Mode 98
 - 8.3.2 Procedures for Isolating One UPS Module from Parallel System 98
 - 8.3.3 Procedures for inserting one isolated UPS module in parallel system 98
 - 8.3.4 Adding a Single Module UPS to a Parallel System Supporting Load 99
 - 8.3.5 Procedures for Completely Powering Down a Multi-Module UPS System 99
- 8.4 LBS System 99
 - 8.4.1 Cabinet Installation 99
 - 8.4.2 External Protective Device 101
 - 8.4.3 Power Cable 101
 - 8.4.4 LBS Cable 101
- 9 Vertiv™ PowerUPS 9000 1250 kVA Modular UPS Option Configurations 105**
- 9.1 Options List 105
- 9.2 Options Introduction 105
 - 9.2.1 Seismic Anchor Kit 105
 - 9.2.2 Vertiv™ Liebert® IntelliSlot™ IS-Relay card 108
 - 9.2.3 Vertiv™ Liebert® IntelliSlot™ RDU120 Card 110
 - 9.2.4 Parallel Cable 110
 - 9.2.5 LBS Cable 110
 - 9.2.6 LBS Extender 111
 - 9.2.7 Single Input Busbar Kit 111
 - 9.2.8 Bypass Backfeed Protection Component (Optional) 111
- 10 Communication 113**
- 10.1 SNMP Protocol Communication 113
- 10.2 Modbus Protocol Communication 113
- 10.3 Dry Contact Communication 113
 - 10.3.1 Communication through IS-Relay Card 113
 - 10.3.2 Communication through Dry Contact Port of Central Control Module 113
- 11 Service and Maintenance 115**
- 11.1 Safety for Service and Maintenance 115
- 11.2 Service Procedures of Power Module and Bypass Power Module 115
- 11.3 Key Components and Service Life of UPS 115
 - 11.3.1 Life Parameters and the Proposed Replacement Time of Key Components 116
 - 11.3.2 Replacement of Air Filter 116
- 11.4 Maintenance of UPS and Options 117

12 Specifications	119
12.1 Conformance and Standards	119
12.2 Environmental Characteristics	119
12.3 Mechanical Characteristics	120
12.4 Electrical Characteristics (Input Rectifier)	120
12.5 Electrical Characteristics (Battery Bus)	121
12.6 Electrical Characteristics (Inverter Output)	122
12.7 Electrical Characteristics (Bypass Input)	122
12.8 Efficiency and Loss	123
Appendices	125
Appendix A: Technical Support and Contacts	125
Appendix B: Glossary	126
Appendix C: Hazardous Substances and Content	128

This page intentionally left blank

1 Important Safety Instructions

Save These Instructions

This manual contains important instructions that should be followed during installation and maintenance of the UPS and batteries of the Vertiv™ PowerUPS 9000 1250 kVA Modular UPS.

Read this manual thoroughly, paying special attention to the sections that apply to your installation, before working with the PowerUPS 9000 1250 kVA Modular UPS. Retain this manual for use by installing personnel.

A properly trained and qualified electrical contractor should install the UPS.

The PowerUPS 9000 1250 kVA Modular UPS cannot be put into operation until it is commissioned by the Vertiv authorized engineer. Otherwise, human safety may be endangered and damage to the UPS will not be covered by the warranty.

The PowerUPS 9000 1250 kVA Modular UPS is designed for commercial and industrial uses and cannot be used as life support equipment.



WARNING! Risk of moving heavy equipment and electric shock. Can cause equipment damage, injury and death. Exercise extreme care when handling UPS cabinets to avoid equipment damage or injury to personnel. The weight range of PowerUPS 9000 1250 kVA Modular UPS from 910 to 1430 kg (862 to 2308 lb). Determine unit weight and locate center of gravity symbols before handling the UPS. Test lift and balance the cabinet before transporting it. Never tilt equipment more than 15 degrees from vertical. In case of fire involving electrical equipment, use only carbon dioxide fire extinguishers or those approved for use in fighting electrical fires. Extreme caution is required when performing maintenance. Be constantly aware that the UPS system contains high DC as well as AC voltages. Check for voltage with both AC and DC voltmeters prior to making contact.



AVERTISSEMENT! Risque lors du déplacement de l'équipement lourd et de décharge électrique pouvant entraîner des dommages matériels, des blessures et même la mort. Faites preuve d'une extrême prudence lors de la manutention des armoires ASC afin d'éviter de les endommager ou de blesser le personnel. L'armoire Liebert® pèse de 391 to 1047 kg (862 to 2308 lb). Repérez les symboles de centre de gravité avant déplacer l'armoire ASC. Faites des essais de levage et d'équilibre avant de transporter l'armoire. N'inclinez jamais l'équipement à plus de 15 degrés à la verticale. En cas d'incendie associé à du matériel électrique, n'utilisez que des extincteurs à dioxyde de carbone ou homologués pour la lutte contre les incendies d'origine électrique. Les opérations d'entretien requièrent une extrême prudence. Soyez toujours conscient du fait que le système ASC contient des tensions c.c. et c.a. élevées. Vérifiez les tensions avec des voltmètres c.a. et c.c. avant d'établir tout contact.



WARNING! Risk of electric shock. Can cause equipment damage, injury, and death.

As with other types of high power equipment, dangerous voltages are present within the UPS and battery enclosure even after input power has been disconnected. The risk of contact with these voltages is minimized as the live component parts are housed behind a metal panel. Further internal safety screens make the equipment protected to IP20 standards. Never remove panels or covers or open doors that will expose internal components to contact. Read and follow all warnings, cautions and safety and operating instructions to avoid serious injury or death from electric shock. No risk exists to any personnel when operating the equipment in the normal manner, following the recommended operating procedures. All equipment maintenance and servicing procedures involve internal access and should be carried out only by trained personnel.



AVERTISSEMENT!

Risque de décharge électrique pouvant entraîner des dommages matériels, des blessures et même la mort. À l'instar des autres types d'équipement haute puissance, des tensions dangereuses sont présentes à l'intérieur de l'armoire ASC et du châssis de batteries même après le débranchement de l'alimentation d'entrée. Le risque de contact avec ces tensions est diminué, car les parties de composants sous tension sont abritées derrière un panneau métallique. D'autres écrans de sécurité internes protègent l'équipement en conformité avec les normes IP20. Ne retirez jamais les panneaux ou les couvercles et n'ouvrez pas les portes donnant accès aux composants internes avec lesquels vous pouvez entrer en contact. Veuillez lire et suivre l'ensemble des avertissements, des mises en garde et des instructions de sécurité et de fonctionnement afin d'éviter des blessures graves, voire la mort, pouvant être causées par une décharge électrique. Il n'y a aucun risque pour le personnel lorsque l'équipement est utilisé normalement, en suivant les procédures de fonctionnement recommandées.

Ground Leakage Current



WARNING! Risk of electric shock from high leakage current. Can cause injury, property damage and death. Earth connection is essential before connecting the input supply. Earth leakage current exceeds 3.5 mA and is less than 3000 mA. Transient and steady state earth leakage currents, which may occur when starting the equipment, should be considered when selecting instantaneous residual current circuit breakers (RCCB) or residual current device (RCD). RCCBs must be selected sensitive to DC unidirectional pulses (Class A) and insensitive to transient current pulses. Note that the earth leakage currents of the load will be carried by this RCCB or RCD. This equipment must be earthed in accordance with the local electrical code of practice.



AVERTISSEMENT! Risque de choc électrique dû à un courant de fuite élevé. Peut causer des blessures, des dommages matériels et la mort. La connexion à la terre est essentielle avant de connecter l'alimentation d'entrée. Le courant de fuite à la terre dépasse 3.5 mA et est inférieur à 3000 mA. Les courants de fuite à la terre transitoires et stationnaires, qui peuvent se produire lors du démarrage de l'équipement, doivent être pris en compte lors de la sélection des disjoncteurs à courant résiduel instantané (RCCB) ou des dispositifs dispositif à courant résiduel (RCD). Les disjoncteurs différentiels doivent être sélectionnés sensibles aux impulsions unidirectionnelles CC (classe A) et insensibles aux impulsions de courant transitoire. Notez également que les courants de fuite à la terre de la charge seront transportés par ce disjoncteur différentiel ou disjoncteur différentiel. Cet équipement doit être mis à la terre conformément au code de pratique électrique local.



WARNING! Risk of electric shock. Can cause injury, property damage and death. Under typical operation and with all UPS doors closed, only normal safety precautions are necessary. The area around the UPS system should be kept free of puddles of water, excess moisture, and debris. Special safety precautions are required for procedures involving handling, installation, and maintenance of the UPS system. Observe all safety precautions in this manual before handling or installing the UPS system as well as during all maintenance procedures. This equipment contains several circuits that are energized with high voltage. Only test equipment designed for troubleshooting should be used. This is particularly true for oscilloscopes. Always check with AC and DC voltmeters to ensure safety before making contact or using tools. Even when the power is turned Off, dangerously high electric charges may exist within the UPS. All power and control wiring should be installed by a qualified electrician. All power and control wiring must comply with the NEC and applicable local codes. ONLY qualified service personnel should perform maintenance on the UPS system. When performing maintenance with any part of the equipment under power, service personnel and test equipment should be standing on rubber mats. The service personnel should wear insulating shoes for isolation from direct contact with the floor (earth ground). Never work alone, even if all power is disconnected from the equipment. A second person should be standing by to assist and summon help in case an accident should occur.



AVERTISSEMENT! Risque de décharge électrique pouvant causer des blessures, des dommages matériels et même la mort. Les précautions de sécurité habituelles suffisent lorsque le système ASC est en mode de fonctionnement normal et que toutes les portes sont fermées. La zone entourant le système ASC doit être exempte de flaques d'eau, d'humidité excessive et de débris. Des précautions de sécurité spéciales sont requises pour les procédures associées à la manutention, à l'installation et à l'entretien du système ASC. Observez toutes les précautions de sécurité décrites dans le présent manuel avant de manipuler ou d'installer le système ASC, ainsi que pendant toutes les procédures d'entretien. Cet équipement comporte plusieurs circuits à haute tension. Seuls des équipements d'essai conçus pour le dépannage doivent être utilisés. Cette mise en garde couvre notamment les oscilloscopes. Utilisez toujours des voltmètres c.a. et c.c. pour vérifier les tensions avant d'établir un contact ou d'utiliser des outils. Des tensions dangereusement élevées peuvent demeurer dans le système ASC même une fois l'alimentation coupée. Tous les câbles d'alimentation et de contrôle doivent être installés par un électricien qualifié. Tous les câbles d'alimentation et de contrôle doivent être conformes au Code national de l'électricité des États Unis (NEC) et celui du Canada, ainsi qu'aux codes locaux en vigueur. L'entretien du système ASC ne doit être confié qu'à des professionnels qualifiés. Les responsables de l'entretien et l'équipement d'essai doivent reposer sur des tapis de caoutchouc lors de toute intervention sur une pièce d'équipement sous tension. Les responsables de l'entretien doivent porter des chaussures isolantes pour prévenir tout contact direct avec le plancher. Ne travaillez jamais seul, même si toute l'alimentation d'entrée est coupée de l'équipement. Une seconde personne devrait toujours être présente pour porter assistance ou chercher de l'aide en cas d'accident.

NOTICE

Risk of improper ground connection. Can cause equipment damage. Ground connection is essential before connecting the input supply. This equipment must be grounded in accordance with local electrical codes. Maximum load must not exceed that shown on the UPS rating label. Risk of improper electromagnetic shielding. Can cause radio communication interference. This unit complies with the limits for a Class A digital device, pursuant to part 15 subpart J of the FCC rules. These limits provide reasonable protection against harmful interference in a commercial environment. This unit generates, uses, and radiates radio frequency energy and, if not installed and used in accordance with this instruction manual, may cause harmful interference to radio communications. This unit is not designed for use in a residential area. Operation of this unit in a residential area may cause harmful interference that the user is solely responsible for correcting.



WARNING! Failure to follow adequate grounding procedures can result in electric shock hazard to personnel, or the risk of fire, should a ground fault occur. All operations described in this section must be performed by properly trained and qualified electricians or technical personnel. If any difficulties are encountered, contact Vertiv. See the back page of this manual for contact information. This device complies with part 15 of the FCC Rules. Operation is subject to the following two conditions: (1) This device may not cause harmful interference, and (2) this device must accept any interference received, including interference that may cause undesired operation.



AVERTISSEMENT! Le non respect des procédures de mise à la terre peut entraîner des risques d'électrocution du personnel, ou des risques d'incendie en cas de défectuosité de la mise à la terre. Toutes les opérations décrites dans cette section ne doivent être effectuées que par des électriciens ou des techniciens professionnels dûment formés et qualifiés . En cas de difficultés, communiquez avec Vertiv. Pour obtenir les renseignements de contact, consultez la dernière page de ce manuel.









NOTICE

Risk of improper ground connection. Can cause equipment damage. Ground connection is essential before connecting the input supply. This equipment must be grounded in accordance with local electrical codes. Maximum load must not exceed that shown on the UPS rating label.

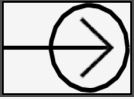
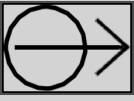
NOTICE

This equipment has been tested and found to comply with the limits for a Class A digital device, pursuant to part 15 of the FCC Rules. These limits are designed to provide reasonable protection against harmful interference when the equipment is operated in a commercial environment. This equipment generates, uses, and can radiate radio frequency energy and, if not installed and used in accordance with the instruction manual, may cause harmful interference to radio communications. Operation of this equipment in a residential area is likely to cause harmful interference in which case the user will be required to correct the interference at his own expense.

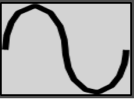
1.1 Glossary of Symbols

	Risk of electrical shock
	Indicates caution followed by important instructions
	AC Input
	AC Output
	Requests the user to read the manual
	Recycle
	DC Voltage
	AC Voltage
	Equipment grounding conductor
	Bonded to ground

This page intentionally left blank

2 Overview

This chapter describes the features, design concept, parallel system, operation mode, battery management, and battery protection of the Vertiv™ PowerUPS 9000 1250 kVA Modular UPS.

2.1 Introduction

The PowerUPS 9000 1250 kVA Modular UPS can be configured as either a fixed capacity or scalable, transformer free, online untransportable power system with 480 VAC capability. The PowerUPS 9000 1250 kVA Modular UPS operates with 50/60 Hz.

When configured for scalability, the capacity of UPS can be set according to **Table 2.1** below.

The PowerUPS 9000 1250 kVA Modular UPS provides continuous, high quality AC power to business-critical equipment, such as telecommunications and data processing equipment. The PowerUPS 9000 1250 kVA Modular UPS supplies power free of the disturbances and variations in voltage and frequency common to utility power, which is subject to brownouts, blackouts, surges, and sags.

The PowerUPS 9000 1250 kVA Modular UPS utilizes the latest high frequency, double conversion pulse width modulation (PWM) technology and fully digital controls to enhance its reliability and increase the ease of use.

The PowerUPS 9000 1250 kVA Modular UPS requires external batteries to support the load when utility power is not present.

Table 2.1 The PowerUPS 9000 1250 kVA Modular UPS Model and Power Scale

Product	Power Scalability	Remark
The PowerUPS 9000 1250 kVA Modular UPS 1250 kVA 480 V 3-wire 50/60 Hz	250, 375, 500, 625, 750, 875, 1000, 1125, 1250	External battery can be configured

2.2 Features

The UPS is connected between a critical load, such as a computer, and mains power to provide high quality power for the loads.

The UPS has the following advantages:

- Improves the input power quality.
- The UPS protects its output against the input power change through the intelligent controller.
- Provides protection for mains failures in the event of a mains direct power source failure.
- If the input power fails, the UPS switches to battery mode and the power supply to the loads will not be interrupted.

2.3 Control and Display Panel

Information about using the UPS control panel is detailed in **Vertiv™ Liebert® Touchscreen Control Panel User Manual SL-26200**, available at Vertiv's web site <https://www.vertiv.com>.

2.4 Operation Modes

The Vertiv™ PowerUPS 9000 1250 kVA Modular UPS has the following operation modes:

- Normal mode
- Battery mode
- Automatic restart mode
- Bypass mode
- ECO mode
- Frequency converter mode
- Dynamic online mode
- LBS mode
- Parallel mode

2.4.1 Normal Mode

As shown in **Figure 2.1** below, the main input AC voltage is converted to DC voltage by the UPS rectifier and converted to conditioned AC voltage by the inverter to supply uninterrupted AC power to the loads. At the same time, the charger use the DC voltage from the rectifier to charge the battery.

Figure 2.1 Schematic Diagram of Normal Mode

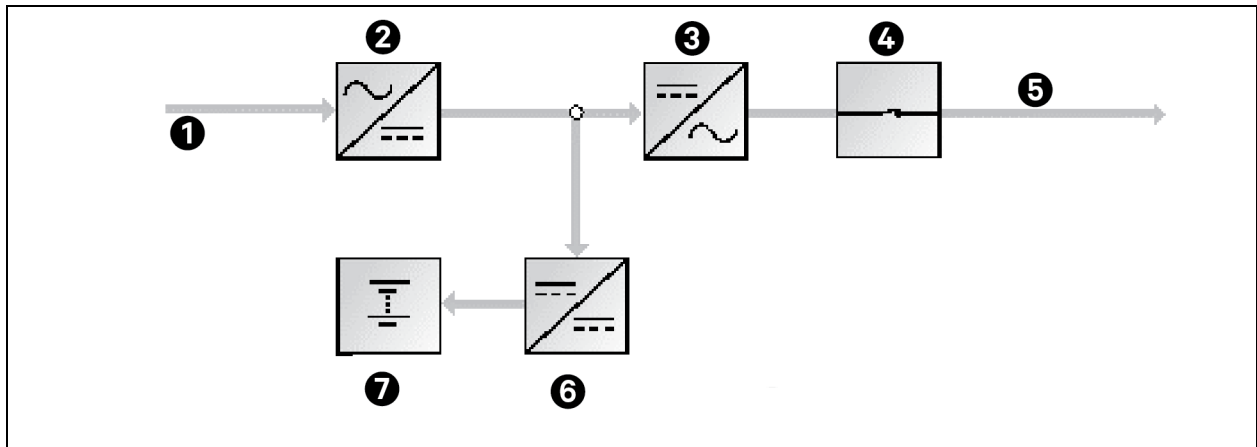

Item	Description	Item	Description
1	Main input	5	UPS output
2	Rectifier	6	Battery charger/discharger
3	Inverter	7	Battery
4	Automatic inverter switch		

2.4.2 Battery Mode

As shown in **Figure 2.2** below, the operation mode in which the battery provides backup DC power supply to inverter to provide backup power to the load. When the load rate exceeds the limit, the auxiliary discharger starts, and the battery provides backup power to the load through the rectifier, auxiliary discharger and inverter. Upon mains failure, the system automatically transfers to the battery mode with no load power interruption. When the mains is recovered, the system automatically transfers back to the normal mode without any manual intervention, and the power to the load will not be interrupted.

Figure 2.2 Schematic Diagram of Battery Mode

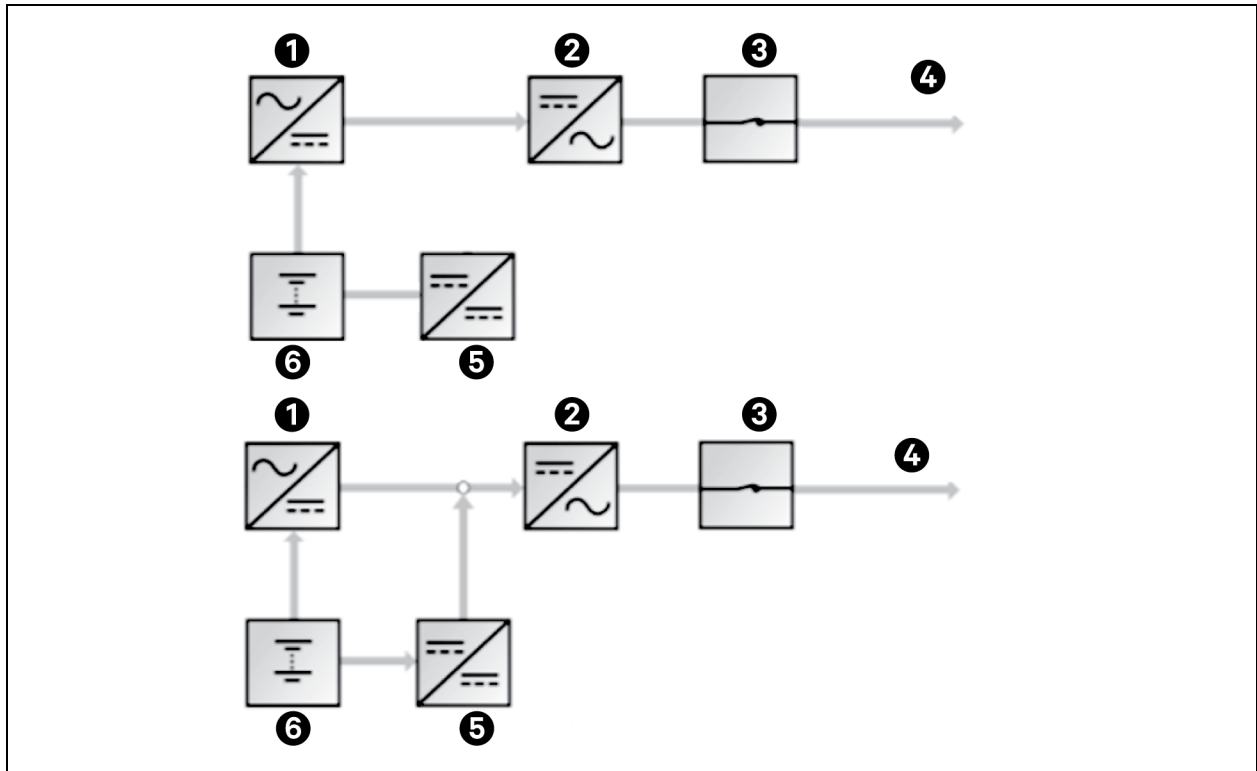

Item	Description	Item	Description
1	Rectifier	4	Output switch
2	Inverter	5	Battery charger/discharger
3	Automatic inverter switch	6	Battery

NOTE: Battery cold start function is available for switching the UPS ON from the battery (charged) mode directly during a mains failure. The battery power supply is used independently to improve the availability of the UPS.

2.4.3 Automatic restart mode

The battery may become exhausted following an extended AC utility failure. The inverter shuts down when the battery reaches the End of Discharge voltage (EOD). The UPS may be programmed to Auto Recovery after EOD after a delay time if the AC utility recovers. This mode and any delay time may be programmed by the commissioning engineer.

NOTE: EOD without battery BCB trip functions must be set by a Vertiv authorized service engineer.

Automatic restart helps to delay the shutdown process and the UPS will charge the battery to protect against the power OFF risk of the load device caused by mains power failure.

NOTE: The user can manually start the UPS through RESET FAULT function if the automatic restart function has not set.

2.4.4 Bypass Mode

When the UPS is in bypass mode and the inverter fails or the inverter gets overloaded or the inverter is shutdown manually, the static switch will transfer the load from the inverter to bypass without interrupting the power to the load. See **Figure 2.3** below for more details.

NOTE: While transferring the load from the inverter to the bypass, if both are not synchronized, the power supply to the power load has transitory interruptions with a time of less than 20 milliseconds.

Figure 2.3 Schematic Diagram of Bypass Mode

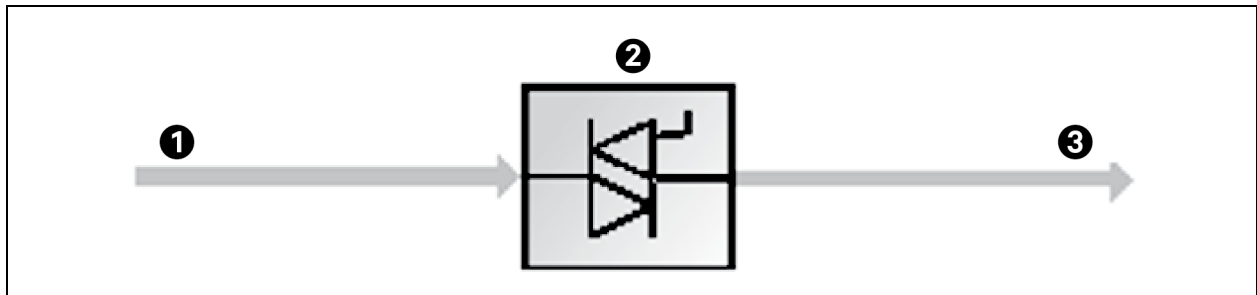

Item	Description
1	Bypass input
2	Static switch
3	UPS output

2.4.5 ECO mode

As shown in **Figure 2.4** on the facing page, if ECO mode is selected, all power breakers and the battery breakers are closed, and the system puts the load on the bypass mode, for energy saving. When the bypass supply is within the range of normal frequency and normal voltage (adjustable), the load is powered by the bypass, with the inverter on standby; when the voltage and/or frequency of the bypass supply are beyond the pre-defined and adjustable limits, the system will transfer to the inverter output. and the transfer time for switching from bypass to inverter is less than 2 milliseconds (uninterrupted) and less than 5 milliseconds (interrupted). In this mode, the system can normally charge the battery.

Figure 2.4 Schematic Diagram of ECO Mode

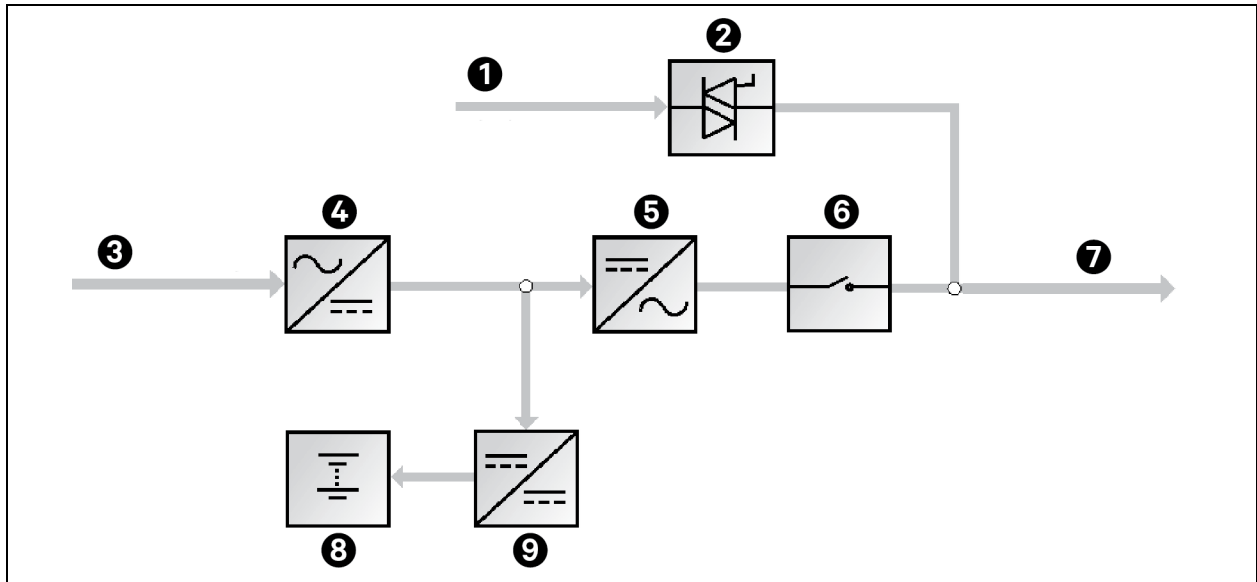

Item	Description	Item	Description
1	Bypass input	6	Automatic inverter switch
2	Static switch	7	UPS output
3	Mains input	8	Battery
4	Rectifier	9	Battery charger/discharger
5	Inverter		

NOTE: If ECO mode is required, adjust the parameters through the touch screen.

The operation method of ECO mode is the same as the description in [Single UPS Operation](#) on page 73. In normal mode, the load is powered by the bypass, the touchscreen displays Bypass mode.

NOTE: In ECO mode, the load is not protected against mains distortion.

2.4.6 Frequency Converter Mode

The UPS can be programmed into frequency converter mode for either 50 Hz or 60 Hz stable output frequency. The input frequency may vary from 40 Hz to 70 Hz. In this mode, open the maintenance bypass breaker and disable the static bypass operation, and the battery becomes optional depending on any requirement to operate in battery mode. The frequency converter mode is set by the service engineer through the setting software.

2.4.7 Dynamic online mode

As shown in [Figure 2.5](#) on the next page, when the UPS is in dynamic online mode, all power breakers and battery breakers are turned ON. The load power is preferentially supplied by bypass to save energy. When the load power supply is provided by bypass, the inverter is in the mode of quality compensation for the bypass voltage. When the bypass voltage exceeds the normal range, the system will switch to the inverter output. In this mode, the battery can still be charged through the charger normally.

NOTE: Refer to Class 1.

Figure 2.5 Dynamic Online Mode

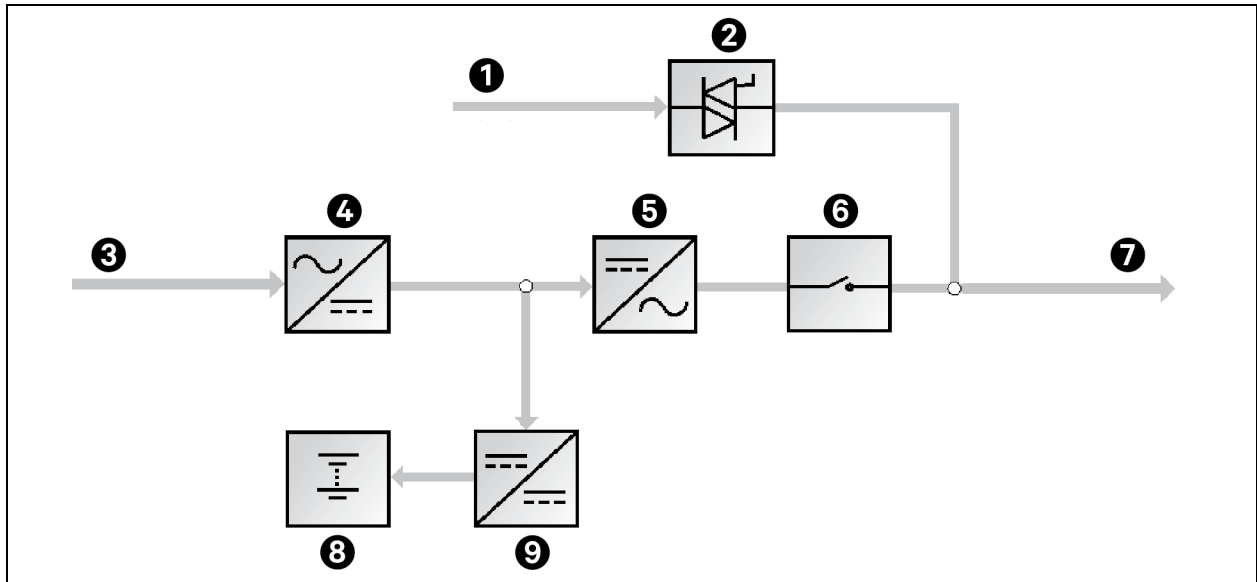

Item	Description	Item	Description
1	Bypass input	6	Automatic inverter switch
2	Static switch	7	UPS output
3	Mains input	8	Battery
4	Rectifier	9	Battery charger/discharger
5	Inverter		

2.4.8 Parallel Mode (system expansion)

For higher capacity or higher reliability, the outputs of multiple UPS units can be programmed for directly paralleling while a built-in parallel controller in each UPS unit ensures automatic load sharing. The parallel system can be composed of up to four UPS units. For the operation principle diagram of the parallel mode, see **Figure 8.2** on page 96.

2.4.9 LBS mode

A dual bus system consists of two independent UPS systems, each containing one or more parallel UPS units. The dual bus system has high reliability and is applicable to the load with multiple inputs. For single-input load, an STS can be installed to power the load. For the operation principle diagram of the LBS mode, see **Figure 8.5** on page 100 and **Figure 8.6** on page 101.

2.5 Battery Management System

Battery management system (BMS) functions are set by the Vertiv service engineer through the setting software.

2.5.1 Normal Function

- **Constant current boost charge:** Adopt the constant current (within battery charging limit) to charge the battery. The function is for fast recovery of battery capacity. The charge current can be set.

- **Constant voltage boost charge:** Adopt the constant voltage to charge battery. The function is for fast recovery of battery capacity.
- **Float charge:** The charging method is for keeping battery in full capacity. The function can balance the capacity loss due to battery self-discharge and is used for battery capacity recovery.
- **Automatic transfer to float charge:** When the charge current is less than threshold of equalize charge to Float Charge or 0.5 A, the charger will automatically transfer from boost charge to float charge. When boost charge time exceeds the equalize charge protect time limit, the charger will transfer to float charge to protect the battery.
- **Float charge temperature compensation (optional):** This function must be used with the battery temperature detection device. The Vertiv battery temperature sensor is a standard option for the selection.
- **EOD protection:** When the battery voltage drops to the EOD voltage, the battery converter shuts down automatically and the battery is inhibited to avoid further battery discharge.
- **Battery low pre-warning time:** The battery low pre-warning time is adjustable between 3 minutes and 60 minutes. The default setting is 5 minutes.
- **Maximum battery discharge time:** When the battery has a small current discharge over a long time, the battery is over discharged and has unrecoverable damage. Setting a battery discharge time to protect the battery is essential. The time limit setting must be configured by service engineer through the Vertiv setting software.
- **Maximum boost charge protection time:** To protect against the battery overcharge damage caused by long time boost charge, a protect time setting is essential. The limit of time setting shall be configured by service engineer through the Vertiv setting software.

NOTE: For detailed battery parameters, please see **Table 12.4** on page 121.

2.5.2 Advanced functions

Parameter	Manual Battery Test	Automatic Battery Test	Remote Battery Test	Calibrated Battery Test
Load	0% <Load <100%	20% <Load <100%	20% <Load <100%	20% <Load <100%
Required Battery Voltage	≥ 97% of float charge voltage	≥ 97% of float charge voltage	≥ 97% of float charge voltage	≥ 97% of float charge voltage
Charger Status	Float charge*	Float charge*	Float charge*	Float charge*
Setting	N/A	Automatic battery test must be enabled and scheduled	N/A	N/A
Trigger	From GHMI	Automatic	Through the input dry contractor	From GHMI
Action	Discharging until battery capacity is 80%	Discharging until battery capacity is 80%	Discharging until battery capacity is 80%	Discharging until battery is close to EOD state
Info	N/A	N/A	Only required when the utility power is present and there are no active alarm conditions.	N/A
* Float charge status required for at least 5 hours with VRLA, high discharge VRLA, wet, Ni-Cd batteries.				

NOTE: The battery continuously discharges to the battery under voltage shutdown threshold. The battery then transfers to the charging state. When the capacity self-test is finished, the system updates the battery curve table.

NOTE: The capacity self-test can be stopped using the touchscreen.

2.5.3 Battery Temperature Compensation

The UPS system has battery charge temperature compensation function. When the ambient temperature is increased, the DC bus voltage (which charges the battery) is reduced correspondingly to provide optimal charging voltage for the battery, prolonging the battery service lifetime.

NOTE: This is applicable to battery types that can accept battery temperature compensation.

2.6 Battery Protection



WARNING! The user must select an appropriate molded case circuit breaker (MCCB) to protect against short circuit and overload for the battery. It is recommended to use the Vertiv battery to provide a better solution.

The following battery protection functions are set by the service engineer through the Vertiv setting software.

2.6.1 Battery Low Pre-warning

The battery low pre-warning occurs before the EOD. After this pre-warning, the battery should have the capacity of 3 minutes discharging with full load. The time can be configured from 3 to 60 minutes.

2.6.2 EOD Protection

When the battery voltage drops to the EOD voltage, the battery shut down automatically. See **Table 12.4** on page 121 for battery EOD voltage parameters of various batteries.

2.6.3 Battery Circuit Breaker Alarm

The external battery connects to the UPS through the battery circuit breaker (BCB). The BCB is manually closed and tripped by the UPS control circuit.

2.7 Parallel System and LBS System

2.7.1 Parallel System

For higher capacity or higher reliability, the outputs of multiple UPS units can be programmed to parallel directly. The built in parallel controller in each UPS module ensures automatic load sharing. A parallel system can include up to four UPS units. For the operation principle diagram of the parallel redundancy mode, see **Figure 8.1** on page 94.

1. The hardware and software of parallel system are completely the same as those of the single module. The parallel system configuration is achieved through settings in configuration software.
2. Parallel cables are connected in a ring, providing both system reliability and redundancy.
3. The total load of the parallel system is identified from the touchscreen of each UPS module.

2.7.2 Parallel System Requirements

A group of parallel units operate as one large UPS with higher reliability. To ensure that all units are equally utilized and to comply with relevant wiring rules, make sure that the following requirements are met.

1. All UPS units must be in the same model and connect to the same bypass source.

2.7.3 LBS System

A dual bus system consists of 2 independent UPS systems, each containing one or more parallel UPS units. Unlike parallel operation, the LBS facilitates a seamless transfer of loads between different UPS systems by ensuring the synchronization of the UPS systems. The dual bus system has high reliability and is applicable to the load with multiple inputs. For a single input load, a static transfer switch (STS) can be installed to power the load. For the operation principle diagram of the LBS mode, see **Figure 8.5** on page 100 and **Figure 8.6** on page 101.

This page intentionally left blank

3 Mechanical Installation

This chapter provides brief instructions for mechanical installation of the Vertiv™ PowerUPS 9000 1250 kVA Modular UPS, including environmental requirements, mechanical requirements, and mechanical considerations necessary when planning the positioning and the cabling of the UPS equipment.

3.1 Precautions

This section is a guide to general procedures and practices that are to be observed by the installation engineer, so that they can troubleshoot the specific situation of the site. The detailed installation steps are not provided in this section due to unique characteristic of each installation site.

NOTE: Professional installation required. Do not disassemble the package without permission of authorized service engineer. The UPS should be installed by an authorized personnel in accordance with the information provided in this chapter.

NOTE: The UPS can be connected to IT, TN, and TT AC distribution systems, and must be a 3-wire (A, B, C, PE) (only for 480 V) system.



WARNING! Risk of electric shock. It can cause damage to the property, serious injury, or death. When connecting batteries, the battery terminal voltage will reach 400 VDC and more. Take special care when installing batteries.

The following safety precautions must be followed while working on the batteries.

- Always wear protective equipment including eye wear and rubber gloves.
- Remove all the metal tools and jewelry, including finger rings, and wristwatch.
- Use tools with an insulated handle.
- If the battery has electrolyte leakage or the battery is damaged, it must be replaced. Place the battery into a container that can withstand sulfuric acid and dispose of it according to local regulations.
- If you meet the battery's electrolyte, wash and flush the area with water immediately. If it meets your eyes, flush them with water and get medical aid immediately.

3.2 Transportation

The recommended mode of transportation is railroad transportation and shipping. If truck transportation is necessary, choose smoother roads to protect the equipment.



WARNING! Risk of moving heavy unit and tipping over while moving. Can cause equipment damage, personnel injury, or death. The UPS cabinet is heavy. See Table 12.2 on page 120 weight of the cabinet. Make sure that any equipment that will be used to move the UPS cabinet has sufficient lifting capacity. The UPS cabinet presents a tipping hazard. Do not tilt the cabinet more than 15 degrees from vertical while transportation.

It is recommended to use mechanical equipment like an electric forklift to unload and transport the cabinet to the installation site. If an electric forklift is used, insert the tines of the forklift below the bottom pallet to prevent the cabinet from falling over. See Figure 3.1 on the next page.

Figure 3.1 Moving the Cabinet (Cabinet Front)

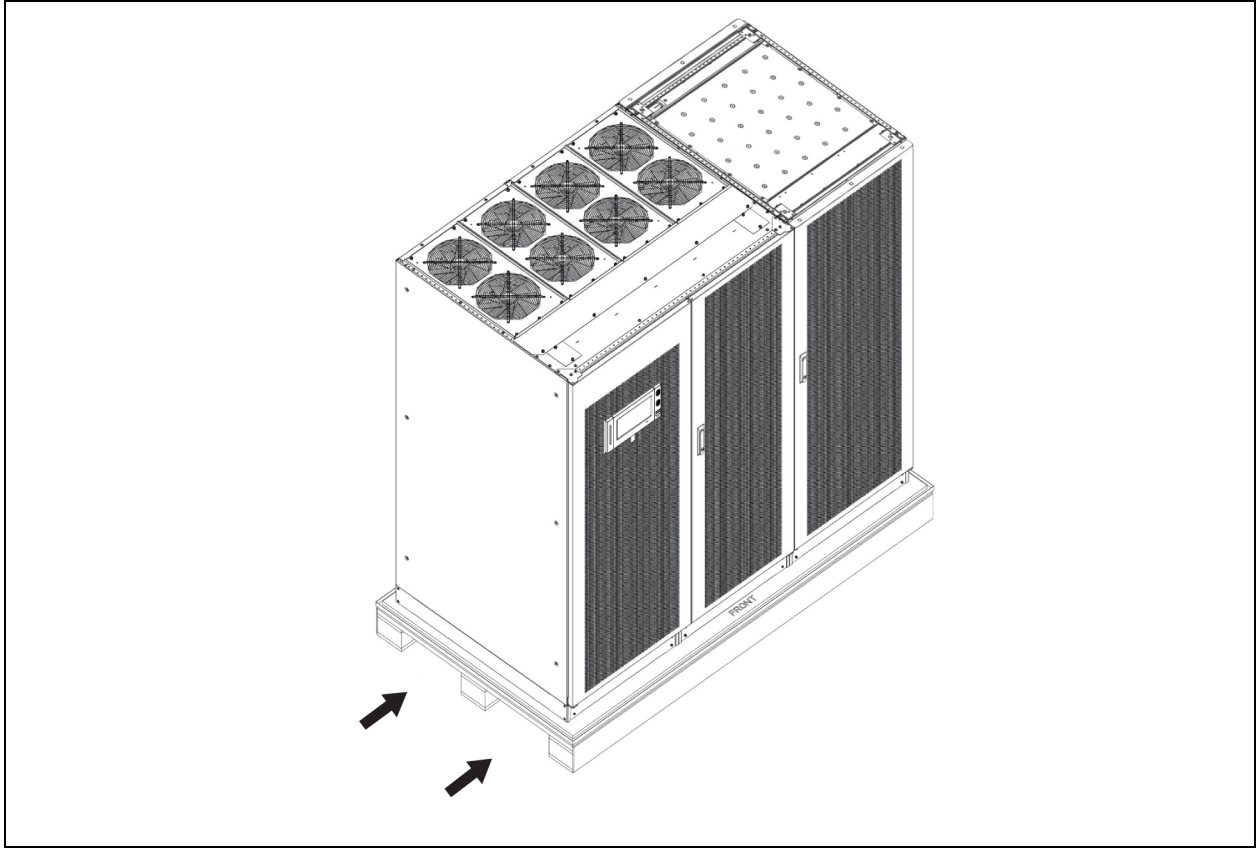

3.3 Tools

Table 3.1 below are the required tools for installation and connection and that the list below is provided for reference.

Table 3.1 Tools

















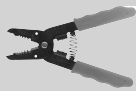



Name	Drawing	Name	Drawing
Electric hand drill		Adjustable wrench	
Slotted screwdriver		Cross head screwdriver	
Stepladder		Forklift	

Table 3.1 Tools (continued)

Name	Drawing	Name	Drawing
Drill		Wire cutting plier	
Claw hammer		Diagonal cutting plier	
Insulating shoes		Antistatic gloves	
Electrician knife		Cable tie	
Insulating tape		Insulating gloves	
Crimping plier		Heat shrinkable tube	
Insulated torque wrench		Torque screwdriver	
Multimeter		Clip-on ammeter	

3.4 Unpacking

Before unpacking the UPS and battery, inspect for any visual damage or signs of mishandling. Under the guidance of authorized service engineer, follow the below steps to unpack the UPS and battery packages.

1. Remove the packing belts and honeycomb boards as shown in **Figure 3.2** on the next page.

Figure 3.2 Removing the Packing Belts and Honeycomb Boards

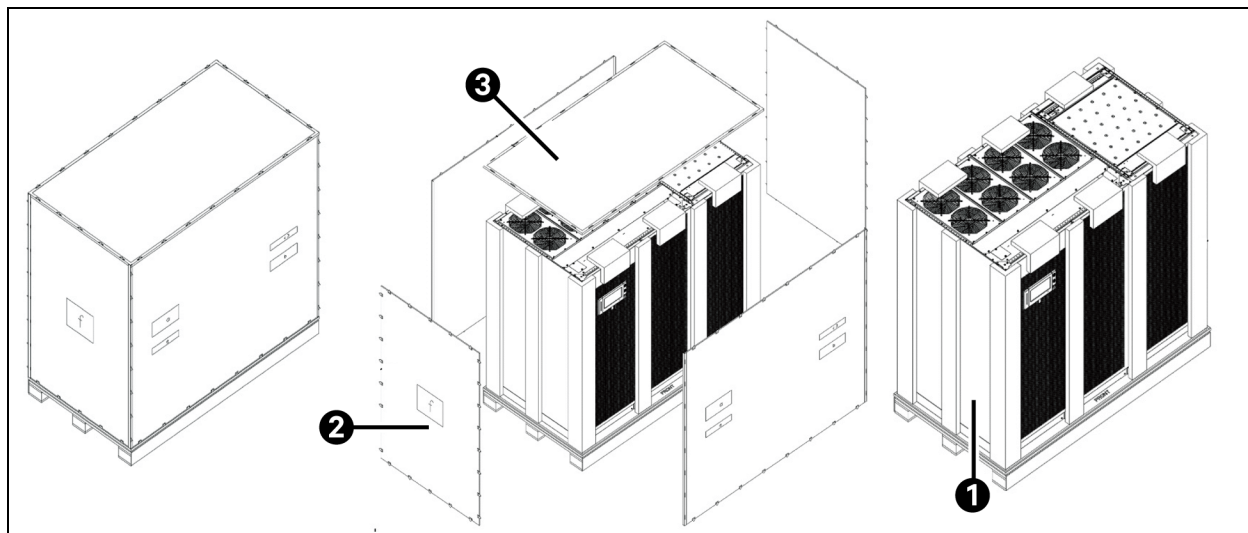

Item	Description
1	Top cover
2	Side pallet
3	Honeycomb board

- Remove the bottom fixing bolts and rodent guards shown in **Figure 3.3** below.

Figure 3.3 Removing Bottom Fixing Bolts

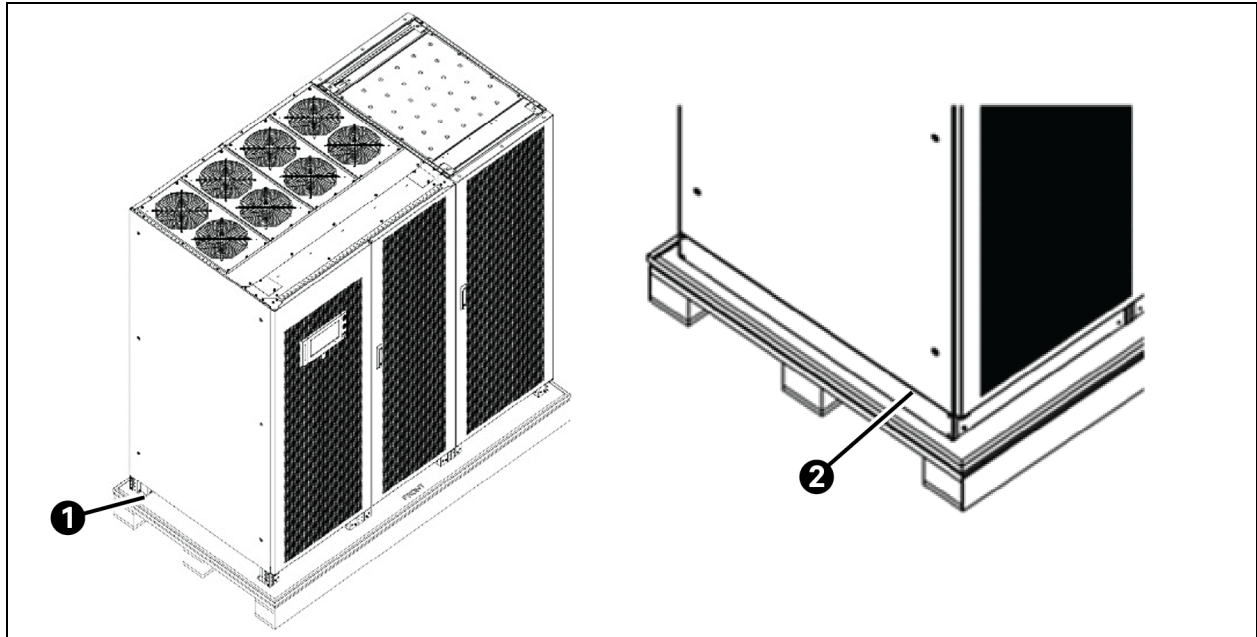

Item	Description
1	Fixing bolt
2	Rodent guard

- Move the cabinet to the installation location using the forklift. See [Transportation](#) on page 17 for more details. Secure cabinet to the ground as shown in **Figure 9.1** on page 106.
- Make sure to reinstall the rodent guards, after the Vertiv™ PowerUPS 9000 1250 kVA Modular UPS is installed.

3.5 Pre-installation Inspection

Before installing the UPS, carry out the following inspections:

- Ensure that the UPS equipment room's environment complies with the environmental requirement specified in the [Environmental Characteristics](#) on page 119, especially the ambient temperature, ventilation conditions, and the dust situations.
- Visually inspect the UPS and battery for any sign of transportation damage or mishandling. Do not attempt to install the system, if damage is apparent. Report it to the carrier or Vertiv representative immediately. Unpack the UPS and battery under the guidance of authorized service engineer.
- Check the UPS label on the back of the door and confirm the contents match the UPS model, capacity and main parameters that were ordered.

3.6 Environmental Requirement

3.6.1 UPS Location Selection

Before installing the Vertiv™ PowerUPS 9000 1250 kVA Modular UPS, verify that the environment of the room where the UPS is to be installed complies with the environmental requirements as specified in relevant international standard and specifications and within operating ranges given in **Table 12.1** on page 119. Pay special attention to the ambient temperature and the air exchange system. Install the UPS in a cool, dry, clean air indoor environment with adequate ventilation and on concrete or other nonflammable, flat surfaces. The ambient environment should be free of conductive powder (such as, metallic powder, sulfide, sulfur dioxide, graphite, carbon fiber, conductive fiber) and acid mist or other conductive media (strongly ionized substances).

The PowerUPS 9000 1250 kVA Modular UPS is cooled by internal fans. Cooling air enters the UPS through the ventilation grills at the front of the cabinet and is exhausted out through the ventilation grills at the back of the cabinet. To permit proper air flow and prevent overheating, do not block, or cover the ventilation openings (ventilation grille) or blow air down onto the unit. The UPS requires at least 24 in. (610 mm) ventilation clearance at the top side of the unit to avoid blocking the UPS heat dissipation, thus reducing the UPS internal temperature, and improving the UPS life.

If necessary, install indoor extractor fans to aid cooling air flow to avoid increase in the room temperature.

NOTE: When installing the UPS, use M12 expansion bolts to fix the base of the cabinet on the floor to prevent the cabinet from falling due to uneven ground.

NOTE: When the battery cabinet is installed near the UPS, the maximum allowable ambient temperature is dependent on the battery rather than the UPS.

NOTE: If the UPS is working in ECO mode, the power consumption will be less than that in Normal mode. Proper air conditioning system shall be selected according to the normal operating mode.

3.6.2 Battery Location Selection

Some battery chemistries generate some hydrogen and oxygen at the end of a charge, so the fresh air volume of the battery installation environment must meet the EN50272-2001 requirements.

The battery can be installed inside a specialized battery cabinet that must be close to the UPS. If the battery is placed on a raised floor, a bracket must be installed under the floor, just as for the UPS. If the battery adopts rack mounting or is mounted far from the UPS with other installation mode, the battery circuit breaker must be installed near the battery and the cabling distance must be minimized.

3.6.3 Storage

If the UPS will not be installed immediately, it must be stored in the original packaging indoors in a clean, dry, and cool location protected from excessive humidity and heat sources. See **Table 12.1** on page 119 for more details. The battery needs to be stored in a dry and cool place with good ventilation. The most suitable storage temperature ranges are 68 °F (20 °C) to 77 °F (25 °C).



WARNING! During battery storage, periodically charge the battery according to the battery manufacturer instructions. Users can obtain battery storage information by consulting the battery manufacturer's data sheet.

3.7 Mechanical Requirement

3.7.1 Composition

For 1250 kVA 480 V UPS, the UPS with I/O cabinet is 82.7 in. (2100 mm) width, which provides bypass back feed protective contractor option and support both top and bottom cable access.

3.7.2 Moving the Cabinet



WARNING! Risk of improper handling. Can cause equipment damage, injury, or death. Use only lifting equipment that is rated for the unit weight by an OSHA-certified rating organization.



CAUTION: The center of gravity of the UPS cabinet is high, avoid falling over during the cabinet movement.



CAUTION: Vertical hanging of cabinet is prohibited.

The UPS cabinet presents a tipping hazard. Do not tilt the cabinet more than 15 degrees from vertical while transportation.

Ensure that the UPS weight is within the designated surface weight loading of any lifting equipment. See **Table 12.2** on page 120 for weight of the UPS.

The Vertiv™ PowerUPS 9000 1250 kVA Modular UPS cabinet can be moved by forklift or other similar lifting equipment.

3.7.3 Clearance

Provide at least minimum clearance required by the PowerUPS 9000 1250 kVA Modular UPS, including 47.24 in. (1200 mm) in front, to permit routine tightening power terminals within the UPS and free passage for personnel with the door fully opened.

For the top fan airflow UPS, there are no ventilation grilles on the sides or back of the UPS, the UPS can be placed against the wall directly if there is no seismic anchoring. If the floor anchoring system used, up to 5 in. (127 mm) may be required in the rear of the UPS. Leave a minimum of 24 unobstructed inches (670 mm) between the UPS and any obstructions (conduit, cable trough, or ceiling). Vertiv recommends against using air conditioning or other systems that blow air across the top of the unit.

Figure 3.4 Clearances

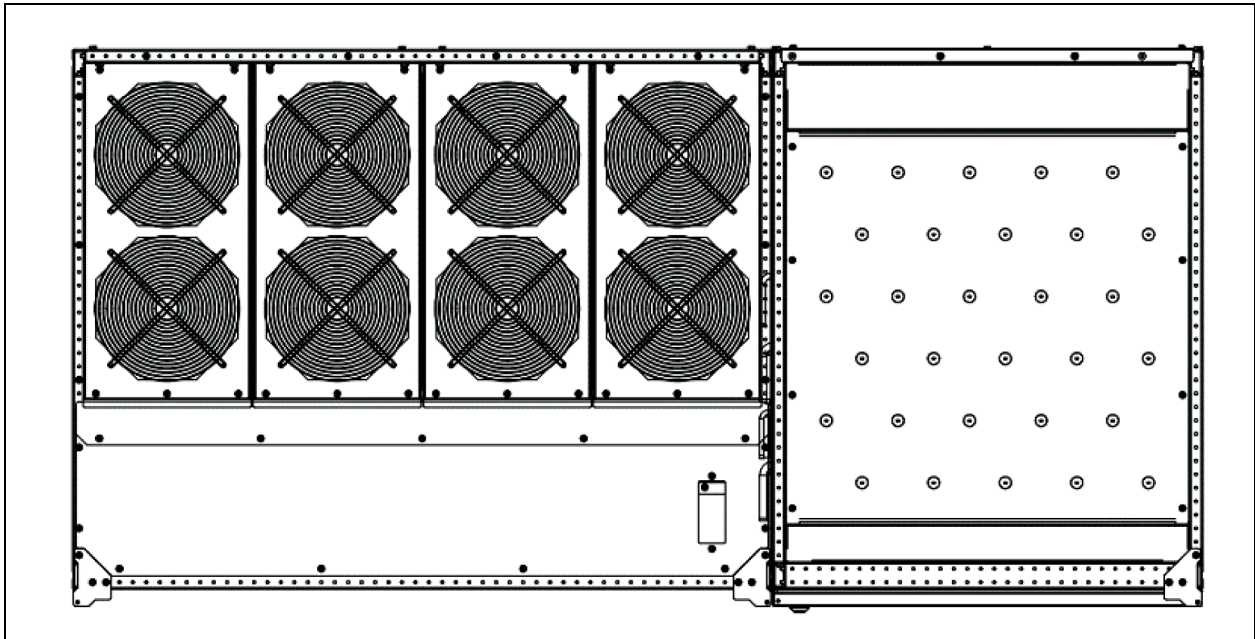

3.7.4 Cable Access

Cables can enter the Vertiv™ PowerUPS 9000 1250 kVA Modular UPS from both top and bottom.

Some plates have factory punched holes and others are designed to allow the personnel to punch holes for fitting and securing the conduit. Once the conduit holes are punched, these plates should be reattached to the UPS. The conduit size and wiring method must be in accordance with all local, regional, and national codes and regulations, including NEC ANSI/NFPA 70.

NOTE: When installing the UPS, the customer must provide a disconnect with over current protection at the output of the UPS.

3.8 Installation

NOTE: When installing cables for full system capacity, it is crucial to plan carefully to ensure all cable lugs are properly landed. It is advisable to follow the installation guidelines outlined in **Figure 3.5** on the facing page. A combination of both top and bottom feeds is also acceptable.

Figure 3.5 Cable Entry Locations

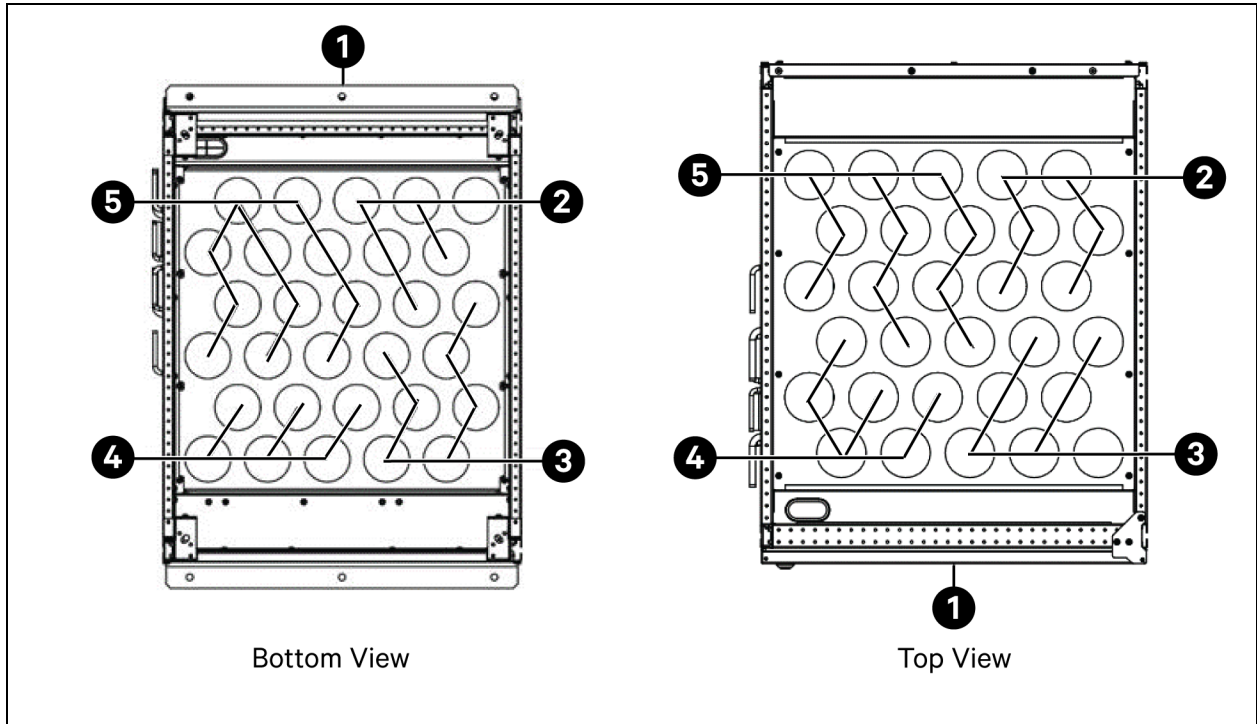

Item	Description	Item	Description
1	Front	4	Output
2	Bypass module input	5	Battery input
3	Power module input		

3.9 Module Components Introduction

3.9.1 Power Module Components

Figure 3.6 Vertiv™ PM125 Power Module Installation Indicators and Controls for 480 V UPS

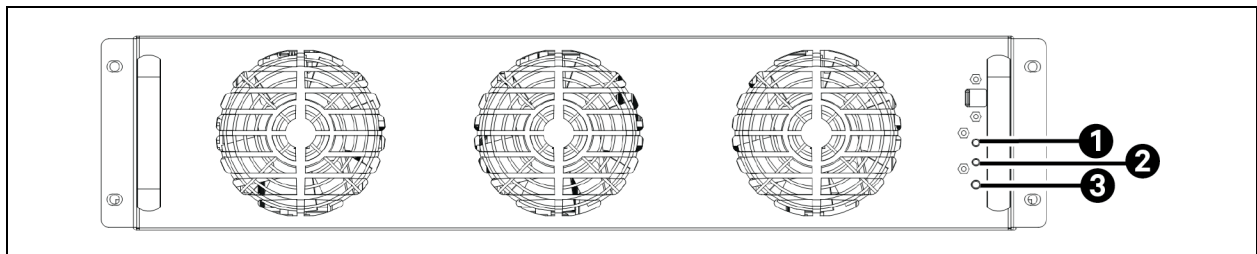

Item	Description
1	Fault LED
2	Run LED
4	Battery cold start switch

The Fault LED illuminates red when the Vertiv™ Power Module Assembly has a problem.

The Run LED illuminates green when the Vertiv™ Power Module Assembly is operating normally.

Table 3.2 LED Indications

LED Status	Indication
Run LED (Green)	
Flashing Green	The inverter is starting but has no output yet.
Constant Green	The inverter has started to supply power.
Off	The inverter has started to supply power. The inverter has not started up.
Fault LED (Red)	
Constant Red	Auxiliary power failure (15 V or 24 V), rectifier over temperature, rectifier failure (including battery SCR short circuit), battery converter failure, soft start failure, main circuit back feed, abnormal input current, inverter failure, output short circuit, bypass SCR short circuit fault, inverter relay short circuit fault, abnormal bus voltage, module not ready, module ID out of range and duplicated module ID.
Flashing Red	Charger failure, abnormal main circuit voltage, abnormal main circuit frequency, main circuit under voltage, main circuit reverse phase, battery unavailable, reverse battery, input zero-loss, current sharing failure, module overload, inverter relay disconnection fault, bypass SCR disconnection fault and input fuse blown.
Off	No above failures or alarms.

3.9.2 Bypass Module Component

Figure 3.7 Vertiv™ Bypass Module Installation Indicators for 480 V UPS

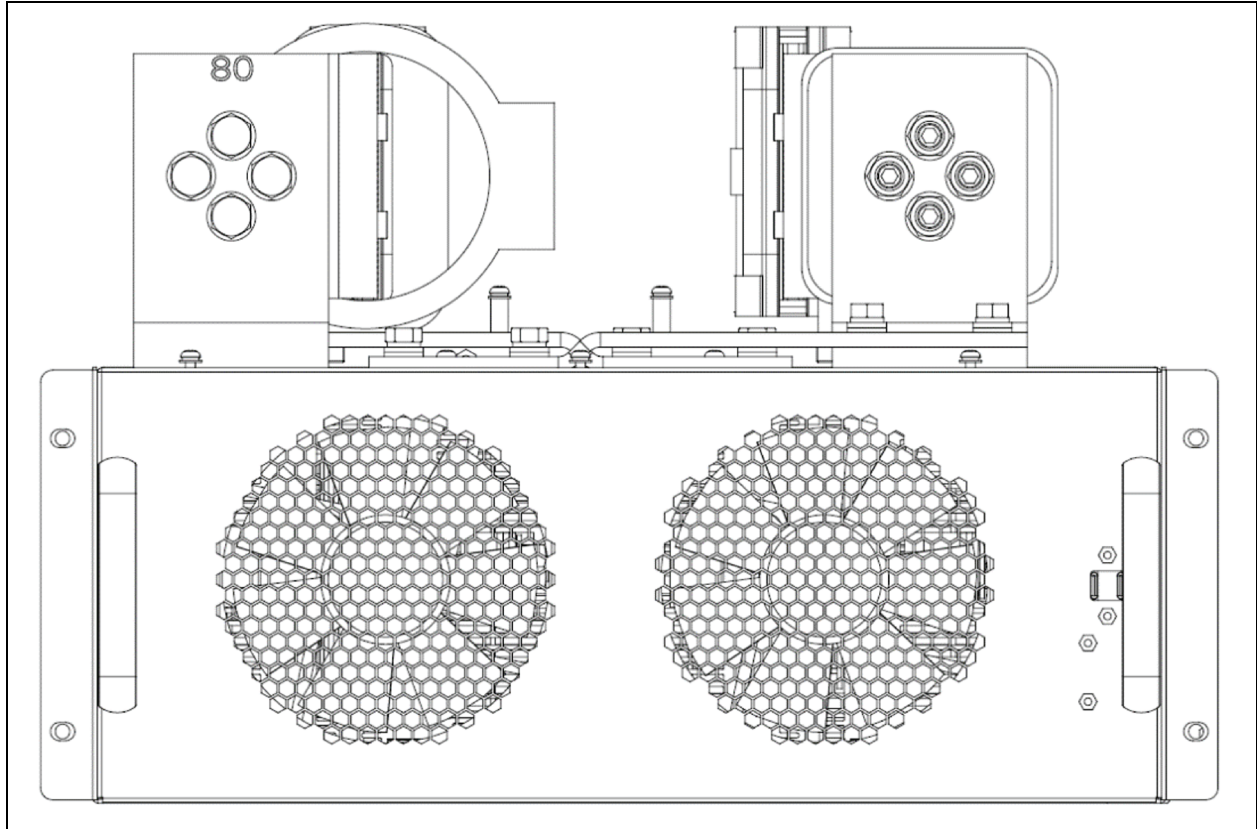

3.9.3 Bypass Control Module Component

Figure 3.8 Vertiv™ Bypass Control Module Installation Indicators for 480 V UPS

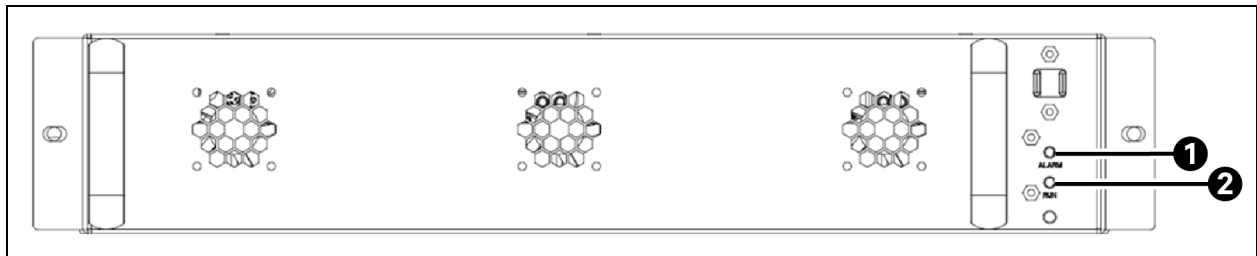

Item	Description
1	Fault LED
3	Run LED

The Fault LED will illuminate red when the Vertiv™ Bypass Module Assembly has a problem.

The Run LED illuminates green when the Vertiv™ Bypass Module Assembly is operating normally.

For information of LED indication see **Table 3.3** on the next page.

Table 3.3 LED Indications

LED Status	Indication
Run LED (Green)	
Flashing Green	The bypass SCR is turned on
Off	The bypass SCR is turned off
Fault LED (Red)	
Constant Red	There is an alarm on the bypass, the bypass monCAN is abnormal
Flashing Red	Bypass fault, EPO, output disabled, unauthorized, module DSP not running
Off	No above failures or alarms

3.9.4 Control Module Component

The Control module has three Vertiv™ Liebert® IntelliSlot™ interface card bays and connections for optional ancillary cabinets and for other options.

Figure 3.9 Static Bypass Assembly Connections

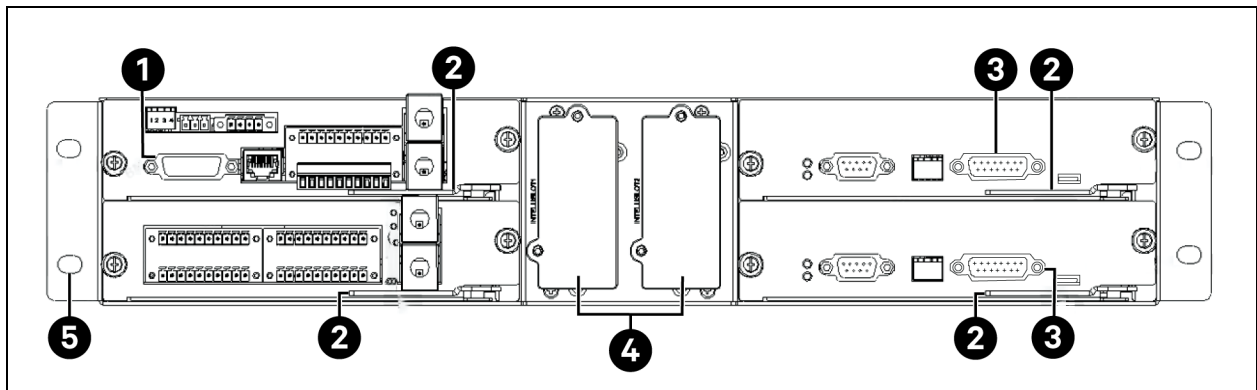

Item	Description	Item	Description
1	HMI	4	Vertiv™ Liebert® IntelliSlot™ Bays 1 and 2
2	Ready switch	5	Screw holes
3	Parallel communication port		

NOTE: See [Figure 4.7](#) on page 45 through [Figure 4.13](#) on page 52 for details.

3.10 Installation Drawings

Figure 3.10 Schematic Diagram of Installing 480 V UPS

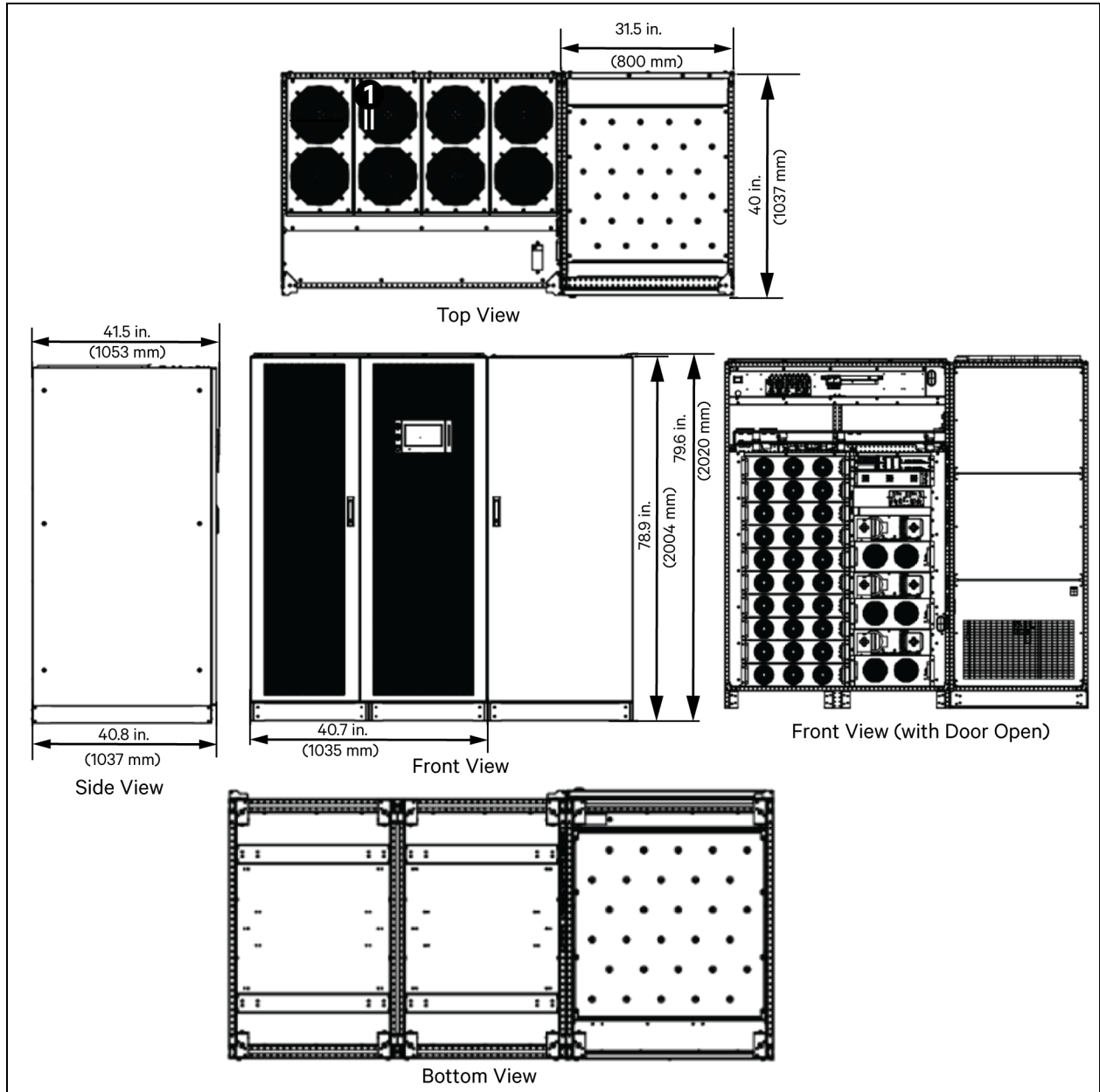

Item	Description
1	Upper outlet fan

This page intentionally left blank

4 Electrical Installation

This chapter describes the electrical installation of the Vertiv™ PowerUPS 9000 1250 kVA Modular UPS.

After completing the mechanical installation of the UPS, it is necessary to connect the power cable and signal cable of the UPS. All signal cables must run separate from power cables in metal conduits or metal ducts that are electrically bonded to the metalwork of the cabinets to which they are connected. All signal cabling must be shielded.



WARNING! Risk of electric shock. Can cause equipment, physical injury, or death. Before connecting input power to the PowerUPS 9000 1250 kVA Modular UPS, ensure that you are aware of the location and operation of the overcurrent protection devices that connect the UPS input/bypass supply to the power distribution panel. Deenergize and lockout or tagout all incoming high and low voltage power circuits before installing cables or making any electrical connections.



AVERTISSEMENT! Risque de décharge électrique pouvant entraîner des dommages matériels, des blessures et même la mort. Avant de procéder au branchement de l'alimentation d'entrée du système de Liebert®, veuillez à prendre connaissance de l'emplacement et du fonctionnement des dispositifs de protection de surintensité qui raccordent l'alimentation d'entrée ou de dérivation du système ASC au panneau de distribution électrique. Coupez l'alimentation et appliquez le verrouillage ou l'étiquetage à tous les circuits d'alimentation haute tension et basse tension avant d'installer les câbles ou d'effectuer tout autre branchement électrique.

4.1 Power Cable Wiring

4.1.1 System Configuration

The main factors affecting the choice and size of cable are voltage, current (also considering overcurrent), room temperature and conditions of installation of the cable. Refer to ANSI/NFPA 70.

The power cables of the system must be sized as follows:

- **UPS input cables:** The UPS input cables must be sized for the maximum input current, including the maximum battery charge current, see **Table 4.1** on the next page.
- **UPS bypass and output cables:** The UPS bypass and output cables must be sized for the nominal output or bypass current, see **Table 4.1** on the next page.
- **Battery cables:** Each UPS connects to its battery through the two cables connecting to the positive pole and negative pole. The cable size of the battery cable differs with the UPS power ratings, provided that it meets the battery discharge current requirement when the battery discharges to near EOD voltage, as shown in **Table 4.1** on the next page.

4.1.2 Maximum Steady State AC and DC Currents

The power cables must be selected in accordance with current and voltage values as given in **Table 4.1** on the next page as well as local wiring regulations and environmental conditions (temperature and physical media).

NOTE: The cables used must be in accordance with NEC ANSI/NFPA 70. Cable sizes should be suitable for operation at a maximum temperature of 104 °F (40 °C).

Table 4.1 Maximum Steady State AC and DC Currents for PowerUPS 9000 1250 kVA 480 V 3-Wire System

UPS Power (kVA)	Rated Current (A)				Bus Stud Bolt/Nut Specification	
	Maximum Input Current ¹	Output Current ² at Full Load	Bypass Current ² at Full Load	Battery Discharge ³ and Current (+, -, N) at Rated Battery Voltage	Input, Battery, Output, Bypass/PE Cable	Recommended Torque (Nm)
250	392	301	301	644	M16	90±10%
375	589	451	451	967	M16	90±10%
500	785	601	601	1289	M16	90±10%
625	981	752	752	1611	M16	90±10%
750	1177	902	902	1933	M16	90±10%
875	1374	1052	1052	2255	M16	90±10%
1000	1570	1203	1203	2577	M16	90±10%
1125	1766	1353	1353	2900	M16	90±10%
1250	1962	1504	1504	3222	M16	90±10%

¹ Maximum input current is calculated according to the low voltage input of 384 V (L-L) and 100% load percentage.

² Maximum output/bypass current is calculated according to the rated voltage and 100% load percentage.

³ The battery discharge current is calculated according to the battery cell number of 40, EOD voltage of 1.63 V and 100% load percentage.

4.1.3 Recommended Cross Section Area of UPS Cable

The recommended Cross Section Area (CSA) of the Vertiv™ PowerUPS 9000 1250 kVA Modular UPS cable is given in **Table 4.2** below to **Table 4.5** on page 35.

Table 4.2 Recommended CSA for Vertiv™ PowerUPS 9000 1250 kVA 480 V 3-Wire System — Rectifier Input

UPS Rating		Voltage (VAC)	Cable Entry	(Type of Conduits) Size of Phase Cables Per Conduit Size of Cable for Ground Per Conduit	
				Copper Conductors	Aluminum Conductors
kVA	kW				
250	250	480	Top	2-2 in. (4/0 awg/ph+3 awg gnd)	2-2.5 in. (250 kcmil/ph+1 awg gnd)
			Bottom	2-2.5 in. (4/0 awg/ph+3 awg gnd)	2-2.5 in. (250 kcmil/ph+1 awg gnd)
375	375	480	Top	2-2.5 in. (350 kcmil/ph+1 awg gnd)	2-3 in. (500 kcmil/ph+2/0 awg gnd)
			Bottom	2-3 in. (350 kcmil/ph+1 awg gnd)	2-3.5 in. (500 kcmil/ph+2/0 awg gnd)
500	500	480	Top	3-2.5 in. (350 kcmil/ph+1/0 awg gnd)	3-3 in. (500 kcmil/ph+3/0 awg gnd)
			Bottom	3-3 in. (350 kcmil/ph+1/0 awg gnd)	3-3.5 in. (500 kcmil/ph+3/0 awg gnd)
625	625	480	Top	3-3 in. (500 kcmil/ph+2/0 awg gnd)	3-3 in. (600 kcmil/ph+4/0 awg gnd)
			Bottom	3-3.5 in. (500 kcmil/ph+2/0 awg gnd)	3-3.5 in. (600 kcmil/ph+4/0 awg gnd)
750	750	480	Top	4-2.5 in. (350 kcmil/ph+3/0 awg gnd)	4-3 in. (500 kcmil/ph+250 kcmil gnd)
			Bottom	4-3 in. (350 kcmil/ph+3/0 awg gnd)	4-3.5 in. (500 kcmil/ph+250 kcmil gnd)

Table 4.2 Recommended CSA for Vertiv™ PowerUPS 9000 1250 kVA 480 V 3-Wire System — Rectifier Input (continued)

UPS Rating		Voltage (VAC)	Cable Entry	(Type of Conduits) Size of Phase Cables Per Conduit Size of Cable for Ground Per Conduit	
kVA	kW			Copper Conductors	Aluminum Conductors
875	875	480	Top	4-3 in. (500 kcmil/ph+4/0 awg gnd)	5-3 in. (500 kcmil/ph+350 kcmil gnd)
			Bottom	4-3.5 in. (500 kcmil/ph+4/0 awg gnd)	5-3.5 in. (500 kcmil/ph+350 kcmil gnd)
1000	1000	480	Top	5-3 in. (500 kcmil/ph+4/0 awg gnd)	6-3 in. (500 kcmil/ph+350 kcmil gnd)
			Bottom	5-3.5 in. (500 kcmil/ph+4/0 awg gnd)	6-3.5 in. (500 kcmil/ph+350 kcmil gnd)
1125	1125	480	Top	6-3 in. (500 kcmil/ph+250 kcmil gnd)	7-3 in. (500 kcmil/ph+400 kcmil gnd)
			Bottom	6-3.5 in. (500 kcmil/ph+250 kcmil gnd)	7-3.5 in. (500 kcmil/ph+400 kcmil gnd)
1250	1250	480	Top	6-3 in. (500 kcmil/ph+250 kcmil gnd)	7-3 in. (500 kcmil/ph+400 kcmil gnd)
			Bottom	6-3.5 in. (500 kcmil/ph+250 kcmil gnd)	7-3.5 in. (500 kcmil/ph+400 kcmil gnd)

NOTE: These values are at ambient temperature of 86 °F (30 °C).

Table 4.3 Recommended CSA for Vertiv™ PowerUPS 9000 1250 kVA 480 V 3-Wire System — Bypass Input

UPS Rating		Voltage (VAC)	Cable Entry	(Type of Conduits) Size of Phase Cables Per Conduit Size of Cable for Ground Per Conduit	
kVA	kW			Copper Conductors	Aluminum Conductors
250	250	480	Top	2-2 in. (3/0 awg/ph+3 awg gnd)	2-2 in. (4/0 awg/ph+1 awg gnd)
			Bottom	2-2 in. (3/0 awg/ph+3 awg gnd)	2-2.5 in. (4/0 awg/ph+1 awg gnd)
375	375	480	Top	2-2.5 in. (250 kcmil/ph+1 awg gnd)	2-2.5 in. (350 kcmil/ph+2/0 awg gnd)
			Bottom	2-2.5 in. (250 kcmil/ph+1 awg gnd)	2-3 in. (350 kcmil/ph+2/0 awg gnd)
500	500	480	Top	3-2.5 in. (250 kcmil/ph+1/0 awg gnd)	3-2.5 in. (350 kcmil/ph+3/0 awg gnd)
			Bottom	3-2.5 in. (250 kcmil/ph+1/0 awg gnd)	3-3 in. (350 kcmil/ph+3/0 awg gnd)
625	625	480	Top	3-2.5 in. (350 kcmil/ph+1/0 awg gnd)	3-3 in. (500 kcmil/ph+3/0 awg gnd)
			Bottom	3-3 in. (350 kcmil/ph+1/0 awg gnd)	3-3.5 in. (500 kcmil/ph+3/0 awg gnd)
750	750	480	Top	3-3 in. (500 kcmil/ph+2/0 awg gnd)	3-3 in. (600 kcmil/ph+4/0 awg gnd)
			Bottom	3-3.5 in. (500 kcmil/ph+2/0 awg gnd)	3-3.5 in. (600 kcmil/ph+4/0 awg gnd)
875	875	480	Top	4-2.5 in. (350 kcmil/ph+3/0 awg gnd)	4-3 in. (500 kcmil/ph+250 kcmil gnd)
			Bottom	4-3 in. (350 kcmil/ph+3/0 awg gnd)	4-3.5 in. (500 kcmil/ph+250 kcmil gnd)
1000	1000	480	Top	4-3 in. (500 kcmil/ph+4/0 awg gnd)	5-3 in. (500 kcmil/ph+350 kcmil gnd)
			Bottom	4-3.5 in. (500 kcmil/ph+4/0 awg gnd)	5-3.5 in. (500 kcmil/ph+350 kcmil gnd)
1125	1125	480	Top	4-3 in. (500 kcmil/ph+4/0 awg gnd)	5-3 in. (500 kcmil/ph+350 kcmil gnd)
			Bottom	4-3.5 in. (500 kcmil/ph+4/0 awg gnd)	5-3.5 in. (500 kcmil/ph+350 kcmil gnd)

Table 4.3 Recommended CSA for Vertiv™ PowerUPS 9000 1250 kVA 480 V 3-Wire System — Bypass Input (continued)

UPS Rating		Voltage (VAC)	Cable Entry	(Type of Conduits) Size of Phase Cables Per Conduit Size of Cable for Ground Per Conduit	
kVA	kW			Copper Conductors	Aluminum Conductors
1250	1250	480	Top	5-3 in. (500 kcmil/ph+4/0 awg gnd)	6-3 in. (500 kcmil/ph+350 kcmil gnd)
			Bottom	5-3.5 in. (500 kcmil/ph+4/0 awg gnd)	6-3.5 in. (500 kcmil/ph+350 kcmil gnd)

NOTE: These values are at ambient temperature of 86 °F (30 °C).

Table 4.4 Recommended CSA for PowerUPS 9000 1250 kVA 480 V 3-Wire System — Bypass Output

UPS Rating		Voltage (VAC)	Cable Entry	(Type of Conduits) Size of Phase Cables Per Conduit Size of Cable for Ground Per Conduit	
kVA	kW			Copper Conductors	Aluminum Conductors
250	250	480	Top	2-2 in. (3/0 awg/ph+3 awg gnd)	2-2 in. (4/0 awg/ph+1 awg gnd)
			Bottom	2-2 in. (3/0 awg/ph+3 awg gnd)	2-2.5 in. (4/0 awg/ph+1 awg gnd)
375	375	480	Top	2-2.5 in. (250 kcmil/ph+1 awg gnd)	2-2.5 in. (350 kcmil/ph+2/0 awg gnd)
			Bottom	2-2.5 in. (250 kcmil/ph+1 awg gnd)	2-3 in. (350 kcmil/ph+2/0 awg gnd)
500	500	480	Top	3-2.5 in. (250 kcmil/ph+1/0 awg gnd)	3-2.5 in. (350 kcmil/ph+3/0 awg gnd)
			Bottom	3-2.5 in. (250 kcmil/ph+1/0 awg gnd)	3-3 in. (350 kcmil/ph+3/0 awg gnd)
625	625	480	Top	3-2.5 in. (350 kcmil/ph+1/0 awg gnd)	3-3 in. (500 kcmil/ph+3/0 awg gnd)
			Bottom	3-3 in. (350 kcmil/ph+1/0 awg gnd)	3-3.5 in. (500 kcmil/ph+3/0 awg gnd)
750	750	480	Top	3-3 in. (500 kcmil/ph+2/0 awg gnd)	3-3 in. (600 kcmil/ph+4/0 awg gnd)
			Bottom	3-3.5 in. (500 kcmil/ph+2/0 awg gnd)	3-3.5 in. (600 kcmil/ph+4/0 awg gnd)
875	875	480	Top	4-2.5 in. (350 kcmil/ph+3/0 awg gnd)	4-3 in. (500 kcmil/ph+250 kcmil gnd)
			Bottom	4-3 in. (350 kcmil/ph+3/0 awg gnd)	4-3.5 in. (500 kcmil/ph+250 kcmil gnd)
1000	1000	480	Top	4-3 in. (500 kcmil/ph+4/0 awg gnd)	5-3 in. (500 kcmil/ph+350 kcmil gnd)
			Bottom	4-3.5 in. (500 kcmil/ph+4/0 awg gnd)	5-3.5 in. (500 kcmil/ph+350 kcmil gnd)
1125	1125	480	Top	4-3 in. (500 kcmil/ph+4/0 awg gnd)	5-3 in. (500 kcmil/ph+350 kcmil gnd)
			Bottom	4-3.5 in. (500 kcmil/ph+4/0 awg gnd)	5-3.5 in. (500 kcmil/ph+350 kcmil gnd)
1250	1250	480	Top	5-3 in. (500 kcmil/ph+4/0 awg gnd)	6-3 in. (500 kcmil/ph+350 kcmil gnd)
			Bottom	5-3.5 in. (500 kcmil/ph+4/0 awg gnd)	6-3.5 in. (500 kcmil/ph+350 kcmil gnd)

NOTE: These values are at ambient temperature of 86 °F (30 °C).

Table 4.5 Recommended CSA for PowerUPS 9000 1250 kVA 480 V 3-Wire System — Battery

UPS Rating		Voltage (VAC)	Cable Entry	(Type of Conduits) Size of Phase Cables Per Conduit Size of Cable for Ground Per Conduit	
				Copper Conductors	Aluminum Conductors
250	250	480	Top	2-2.5 in. (500 kcmil/polarity+1/0 awg gnd)	3-2.5 in. (350 kcmil/polarity+3/0 awg gnd)
			Bottom	2-3 in. (500 kcmil/polarity+1/0 awg gnd)	3-2.5 in. (350 kcmil/polarity+3/0 awg gnd)
375	375	480	Top	3-2.5 in. (500 kcmil/polarity+2/0 awg gnd)	4-2.5 in. (350 kcmil/polarity+4/0 awg gnd)
			Bottom	3-3 in. (500 kcmil/polarity+2/0 awg gnd)	4-2.5 in. (350 kcmil/polarity+4/0 awg gnd)
500	500	480	Top	4-2.5 in. (500 kcmil/polarity+4/0 awg gnd)	5-2.5 in. (500 kcmil/polarity+350 kcmil gnd)
			Bottom	4-3 in. (500 kcmil/polarity+4/0 awg gnd)	5-3 in. (500 kcmil/polarity+350 kcmil gnd)
625	625	480	Top	5-3 in. (600 kcmil/polarity+250 kcmil gnd)	6-3 in. (600 kcmil/polarity+400 kcmil gnd)
			Bottom	5-3 in. (600 kcmil/polarity+250 kcmil gnd)	6-3.5 in. (600 kcmil/polarity+400 kcmil gnd)
750	750	480	Top	5-3 in. (600 kcmil/polarity+250 kcmil gnd)	6-3 in. (600 kcmil/polarity+400 kcmil gnd)
			Bottom	5-3 in. (600 kcmil/polarity+250 kcmil gnd)	6-3.5 in. (600 kcmil/polarity+400 kcmil gnd)
875	875	480	Top	6-3 in. (600 kcmil/polarity+350 kcmil gnd)	7-3 in. (700 kcmil/polarity+600 kcmil gnd)
			Bottom	6-3 in. (600 kcmil/polarity+350 kcmil gnd)	7-3.5 in. (700 kcmil/polarity+600 kcmil gnd)
1000	1000	480	Top	8-3 in. (500 kcmil/polarity+500 kcmil gnd)	8-3 in. (700 kcmil/polarity+600 kcmil gnd)
			Bottom	8-3 in. (500 kcmil/polarity+500 kcmil gnd)	8-3.5 in. (700 kcmil/polarity+600 kcmil gnd)
1125	1125	480	Top	8-3 in. (500 kcmil/polarity+500 kcmil gnd)	8-3 in. (700 kcmil/polarity+600 kcmil gnd)
			Bottom	8-3 in. (500 kcmil/polarity+500 kcmil gnd)	8-3.5 in. (700 kcmil/polarity+600 kcmil gnd)
1250	1250	480	Top	9-3 in. (750 kcmil/polarity+500 kcmil gnd)	11-3 in. (700 kcmil/polarity+750 kcmil gnd)
			Bottom	9-3.5 in. (750 kcmil/polarity+500 kcmil gnd)	11-3.5 in. (700 kcmil/polarity+750 kcmil gnd)

NOTE: These values are at ambient temperature of 86 °F (30 °C).

NOTE: Recommended cable sizes are 167 °F (75 °C) (THW) wire at 86 °F (30 °C) ambient.

NOTE: Refer to NEC recommendations for 104 °F (40 °C) ambient rated conductors.

NOTE: Unless otherwise noted, use copper or aluminum conductors suitable for at least 167 °F (75 °C).

NOTE: Recommended cables and conduits are based on breaker trip setting sized for the maximum continuous rated current for the rectifier input and the nominal current for the bypass and output listed in on the previous page, through on the previous page.

NOTE: Conduit size is based on RNC type conduit for bottom input and EMT-type conduit for top input.

NOTE: Vertiv recommends that the site planner choose the appropriate cable type based on the installation requirements.

NOTE: These recommendations are for use with 100% rated breakers. For 125% rated breakers, refer to the NEC recommended conduit and cable sizes.

NOTE: Upstream and downstream non-standard recommended breaker settings have their trip adjustment behind a suitable cover in accordance with 240.6© of the NEC.

4.1.4 Recommended Breaker of UPS OPD

NOTE: The branch circuit overcurrent protection breakers used must be in accordance with NEC ANSI/NFPA 70 and the Canadian Electrical Code, Part I, C22.1. A disconnect breaker must be provided which will be used as overcurrent Protection device for AC input, DC input and AC output.

- Rectified input breaker (RIB)
- Bypass isolation breaker (BIB)
- Maintenance bypass breaker (MBB)
- Maintenance isolation breaker (MIB)
- Battery circuit breaker (BCB)

All recommended breakers are all 100% rated breaker.

Table 4.6 Recommended OPD for 480 V 3-Wire System

Model (kVA)	RIB (A)	MIB (A)	BIB (A) and MBB (A)	BCB (A)
250	400	350	350	700
375	600	500	500	1000
500	800	700	700	1400
625	1000	800	800	2000
750	1200	1000	1000	2000
875	1400	1200	1200	2500
1000	1600	1400	1400	3000
1125	2000	1400	1400	3000
1250	2000	1600	1600	4000

NOTE: These values are at Ambient Temperature of 86 °F (30 °C).

4.1.5 General Information

The following points are for general guidance only. If there are relevant local regulations, then follow the local regulations.

1. The protective earth cables must be selected in accordance with the AC power failure level, cable length, and protection type. The shortest connection route must be used for the grounding wire connection.
2. The parallel connection of small cables can be used to make easier installation for cables which are carrying large current.
3. The battery cable size must be selected in accordance with the current value given in [Maximum Steady State AC and DC Currents](#) on page 31 and a maximum allowed voltage drop is 4 VDC.
4. Avoid creating the coils to reduce the generation of electromagnetic interference (EMI).
5. Make sure to leave sufficient wiring space before wiring.

4.1.6 Power Cable Connecting Terminal

The rectifier input, bypass input, output, and battery power cables are connected to the respective terminals as specified in the [Power Cable Connection Steps](#) on the next page.

4.1.7 Protective Ground

The protective earth cable is securely connected to the PE input terminal through the fixing bolt. See [Power Cable Connection Steps](#) on the next page for more details. All the cabinets and cable conduits must be grounded according to the local regulations. The grounding wires must be securely fastened to prevent the loosening of the grounding wire tightening screws when the grounding wires are pulled.



WARNING! Failure to ground as required may cause EMI, electric shock, or fire risk.

4.1.8 External Protective Devices

For safety concerns, it is necessary to install the external circuit breakers or other protective devices for the input and battery of the UPS system. This section provides generic practical information for the qualified installation engineers due to the different specific installations. The qualified installation engineers must be knowledgeable about local regulatory wiring standards on the equipment to be installed.

Rectifier and bypass input supply of the UPS:

1. Input overcurrent and short circuit protection.

Install suitable protective devices in the distribution line of the incoming mains supply, considering the power cable current carrying capacity, system overload capacity, as shown in **Table 12.5** on page 122 and the short circuit capability of the upstream power distribution. The protective devices should provide functions such as the overcurrent protection, short circuit protection, isolation protection and tripping upon backfeed.

2. Split bypass configuration.

If the UPS uses split bypass configuration, a separate protective device should be installed respectively on the rectifier input and bypass input in the distribution lines.

3. Ground fault protection.

If the upstream input power supply has a RCD, the transient state and steady state ground leakage current upon the start-up of the UPS must be considered.

The RCCB must meet the following requirements:

- Must be sensitive to the DC unidirectional pulse (class A) of the whole distribution network.
- Must be insensitive to transient state current pulse.
- Must have an average sensitivity, adjustable between 0.3 A to 3 A.

The RCCB symbols are shown in **Figure 4.1** on the next page.

Figure 4.1 RCCB Symbols

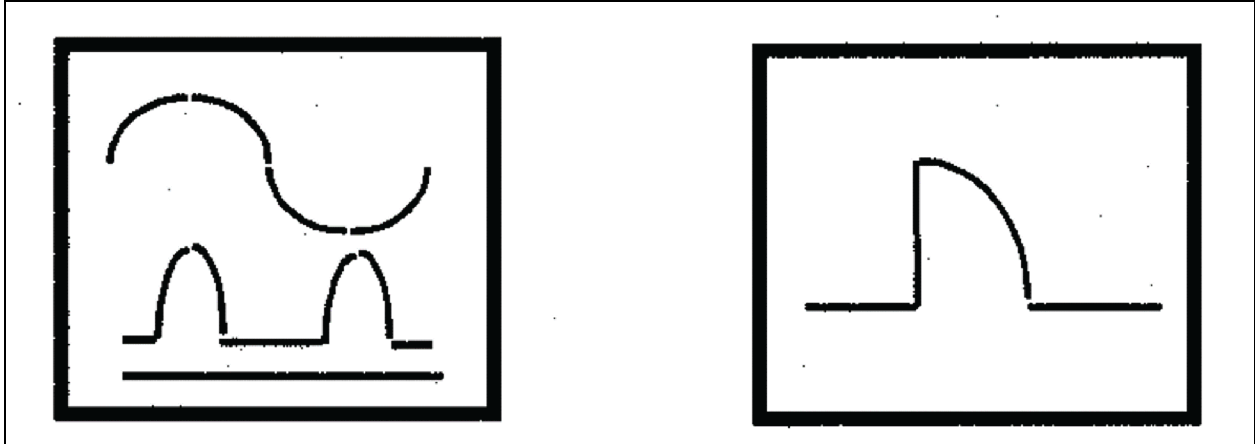

The UPS consist of an internal EMC filter, therefore the protective earth cable's leakage current is less than 3000 mA. It is recommended to verify the RCD sensitivity of the upstream input distribution and the downstream distribution (to the load).

External battery

If a battery breaker has been installed for protecting the external battery. The battery breaker will provide overcurrent protection, short circuit protection and automatic tripping functions for the external battery.

This battery breaker is important for the battery maintenance and is generally installed near the battery. While some battery manufacturers may not mandate the use of a battery breaker, they typically provide an alternative method for disconnecting power flow, such as a switch or contactor. This disconnect mechanism is used alongside DC-rated fuses to protect against overcurrent and short circuits.

The UPS output distribution must be configured with a protective device. The protective device must be different from the input distribution protection switch and able to provide overload protection, as shown in **Table 12.5** on page 122.

NOTE: An IT grid system, 4-pole protective components must be installed for the UPS external input power distribution.

4.1.9 Power Cable Connection Steps

Connection Terminal

See **Figure 4.2** on the facing page and **Figure 4.3** on page 40 for the connection terminals of the 480 V UPS power cable.

Figure 4.2 Power Cable Connection Terminals for 480 V UPS 1250 kVA (without BFD)

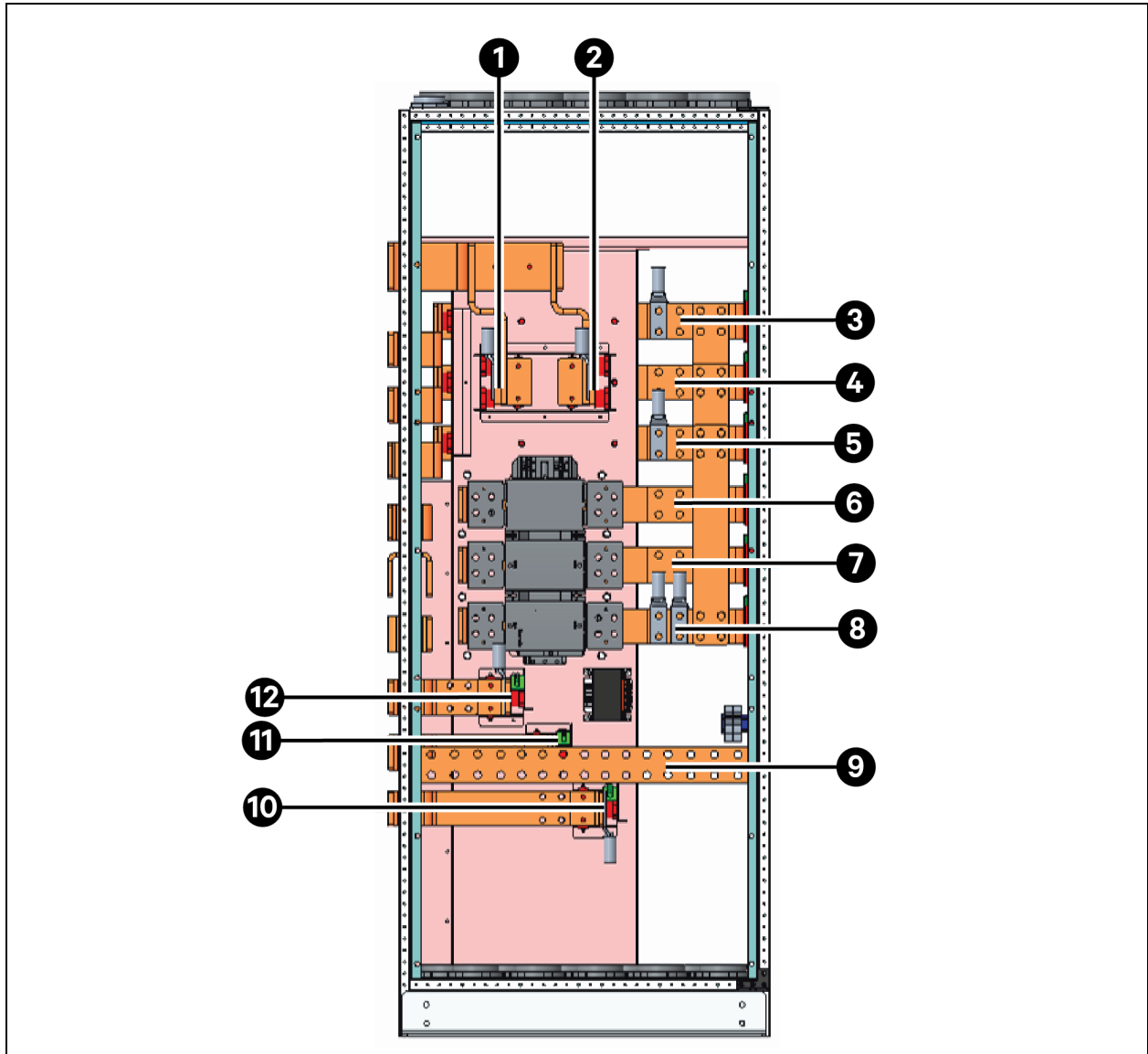

Item	Description	Item	Description
1	BAT +	7	bB
2	BAT -	8	bC
3	mA	9	PE
4	mB	10	oC
5	mC	11	oB
6	bA	12	oA

Figure 4.3 Power Cable Connection Terminals for 480 V UPS 1250 kVA (with BFD)

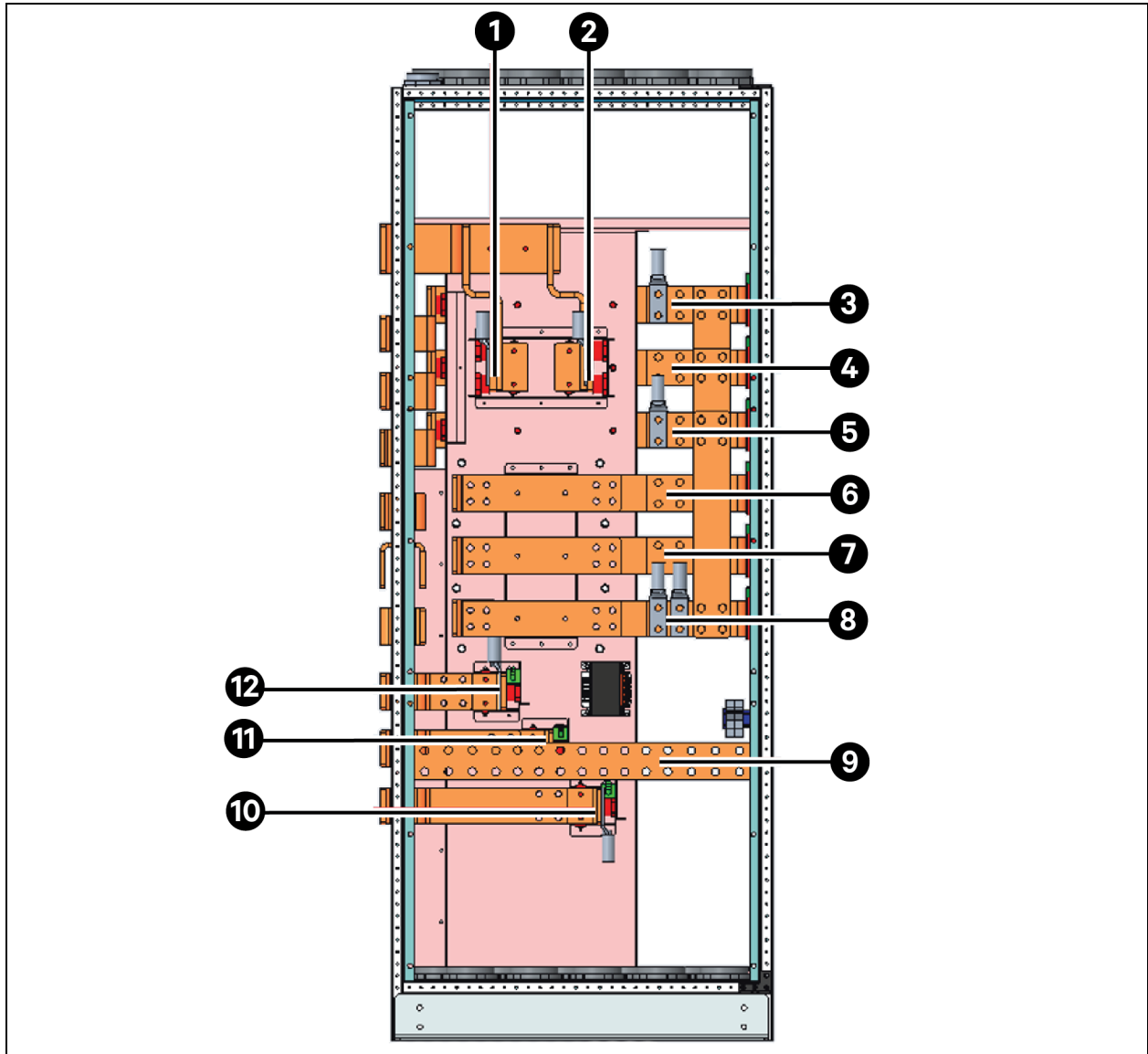

Item	Description	Item	Description
1	BAT +	7	bB
2	BAT -	8	bC
3	mA	9	PE
4	mB	10	oC
5	mC	11	oB
6	bA	12	oA

NOTE: The power cables should be routed through cable conduits to prevent cable damage due to mechanical stress. After that reduce the electromagnetic interference to the surrounding environment.

NOTE: It is necessary to tie and fix the cables when routing the cables inside the cabinets to prevent cable damage because of mechanical stress.

Cabling Procedure



CAUTION: The operations described in this section must be performed by authorized electricians or qualified technical personnel. If you have any difficulties, contact your local Vertiv representative or Vertiv Services.



PRUDENCE: Toutes les opérations décrites dans cette section ne doivent être effectuées que par des électriciens ou des techniciens professionnels dûment formés et qualifiés . En cas de difficultés, communiquez avec Vertiv. Pour obtenir les renseignements de contact, consultez la dernière page de ce manuel.

NOTE: Hydraulic pressure pliers, combinative tools, and piston ring pliers should be used to connect AC wiring.

Once the equipment has been positioned and secured for operation, and the battery and ground lugs have been connected (see Cable Connections), connect the power cables as described below. Study the reference drawing in [Installation Drawings](#) on page 29.

1. Verify that all incoming high and low voltage power circuits are de-energized and locked out or tagged out before installing cables or making any electrical connections.
2. Remove the front I/O panel to gain easier access to the connection of busbars.
3. Connect the facility ground and ancillary ground bus cables to the copper ground busbar. All cabinets in the UPS system must be connected to the user's ground connection.

NOTE: The grounding arrangement must comply with the National Electrical Code and all applicable local codes.

4. Identify and make power connections with incoming cables according to For common bypass and main inputs, connect the AC input supply cables to the UPS input terminals (BYP-A, BYP-B, BYP- C) and tighten the connections to 797 lb-in. (90 Nm) (M16 bolt). Ensure correct phase rotation. Refit all protective covers removed for cable installation. For more information see **Figure 3.5** on page 25.

The UPS supports both top and bottom cable access. See **Figure 4.4** on the next page for details.

NOTE: Conduits are installed on both upper and lower cable entry holes. Follow the conduit wiring access wiring instructions.



WARNING! Risk of electric shock. Can cause equipment damage, personnel injury, or death. Verify that all external and internal power switches of the UPS are turned off and locked out or tagged out before installing the cables or making any electrical connections. Also, measure the voltages between the UPS terminals and the voltages between the terminals and the earth.

Figure 4.4 Power Cables Wiring Route 480 V 1250 kVA (Top Cable Access)

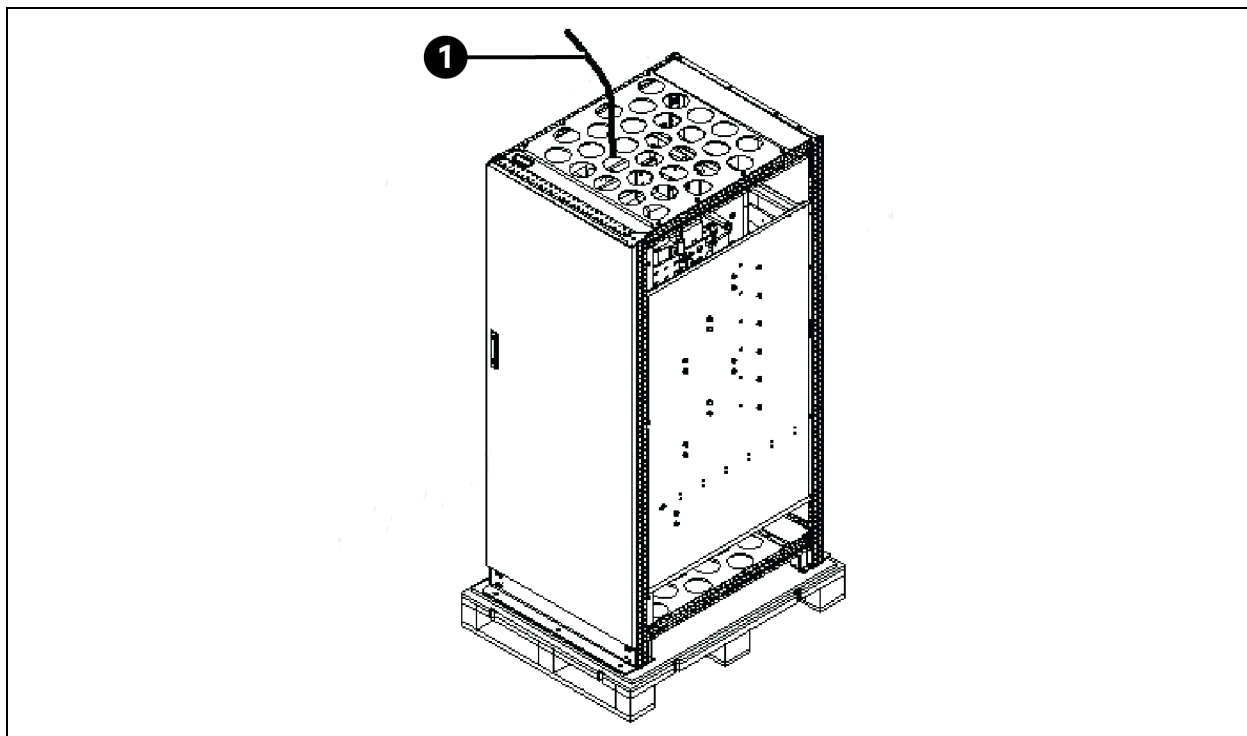

Item	Description
1	Power cable through top cabinet entry plate

Figure 4.5 Power Cables Wiring Route 480 V 1250 kVA (Bottom Cable Access)

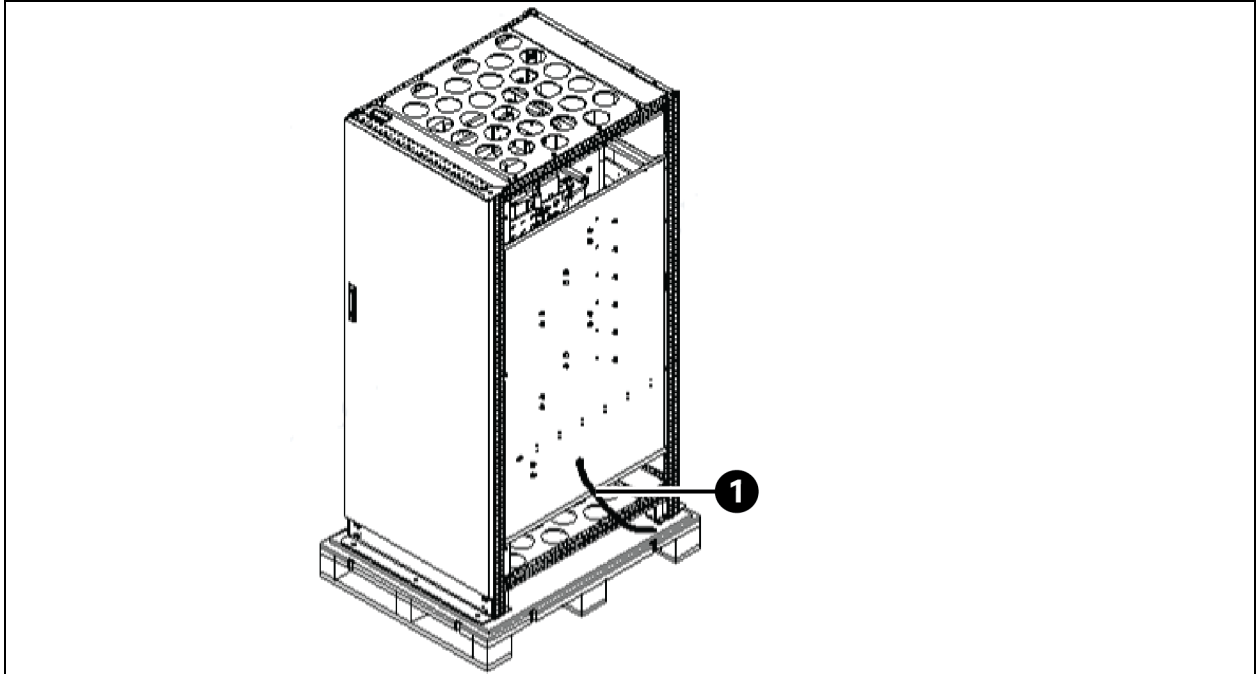

Item	Description
1	Power cable through the bottom cabinet hole.



WARNING! Risk of electric shock or fire. Can cause equipment damage, personnel injury, or death. The earth grounding cable and neutral line connection must comply with the national electrical code and all the applicable local code.

Figure 4.6 Conduit Wiring Access

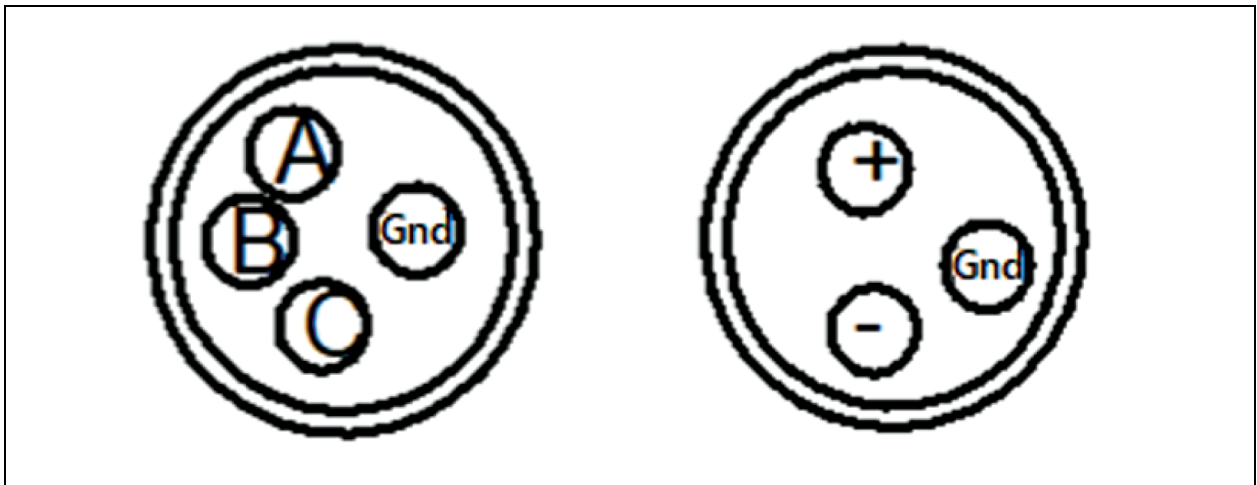

The recommended wiring sequence for UPS is shown in [Figure 3.5](#) on page 25.

Common Input Connection

For common bypass and main inputs, connect the AC input supply cables to the UPS input terminals (BYP-A, BYP-B, BYP-C) and tighten the connections to 797 lb-in. (90 Nm) (M16 bolt). Ensure correct phase rotation. See **Figure 4.2** on page 39 and **Figure 4.3** on page 40 for additional details.

Dual Bypass Connections

If a split bypass configuration is used, connect the AC input supply cables to the rectifier input terminals (REC-A, REC-B, REC-C) and the AC bypass supply cables to the bypass input terminals (BYP-A, BYP-B, BYP-C) and tighten the connections according to [Power Cable Connection Steps](#) on page 38.

NOTE: For split bypass operation, ensure that the busbars between bypass and rectifier inputs are removed.

Output System Connections Ensure Correct Phase Rotation

1. Connect the system output cables between the UPS output busbars (OUT-A, OUT-B, OUT-C terminals) and the critical load and tighten the connections according to [Power Cable Connection Steps](#) on page 38.



WARNING! Risk of electrical shock and arc flash. Can cause property damage, injury and death. If the load equipment will not be ready to accept power when the commissioning engineer arrives, ensure that the system output cables are safely isolated.



AVERTISSEMENT! Risque de décharge électrique pouvant causer des blessures graves, voire mortelles. Si les équipements branchés ne sont pas prêts à être alimentés à l'arrivée de l'ingénieur de mise en service, assurez-vous que les bornes des câbles de sortie du système soient isolées de façon sécuritaire.

NOTE: Observe the battery cable polarity. Be sure that the battery connections, if any, are made with the correct polarity.

2. Refit all protective covers removed for cable installation.

Connecting Batteries

1. Ensure correct polarity of the connections from the battery cabinet to the battery input terminals (BAT+, BAT-) in the UPS cabinet, that is, (BAT+) to (+) and (BAT-) to (-). Do not reconnect these links and do not close the battery breaker before authorized to do so by the service engineer.
2. Refit all protective covers removed for cable installation.

NOTE: After connection, make sure to seal the cable entry hole on the cabinet.

4.2 Wiring of Signal Cable

4.2.1 Overview

Based on the site's specific requirements, the Vertiv™ PowerUPS 9000 1250 kVA Modular UPS can require an auxiliary connection to manage the battery system management (including the external battery switch), communicate with a personal computer, provide alarm signal to the external devices, for the remote emergency power off (REPO) or provide bypass back feed circuit breaker signal and parallel communication. These functions are performed through the communication box in the UPS cabinet. The communication box provides the ports as shown in **Figure 4.7** below.

Figure 4.7 Overview of Communication Ports

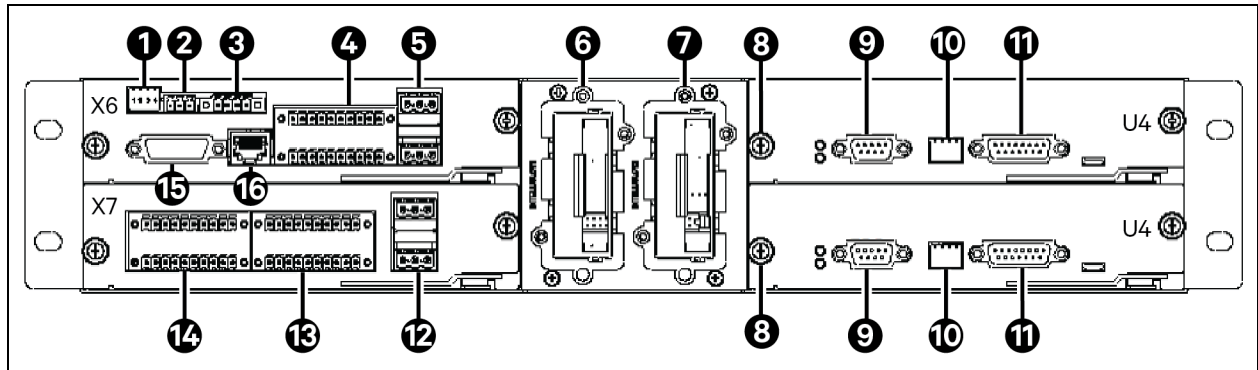

Item	Description	Item	Description
1	X6 SW1	9	U4 LBS synchronize signal port
2	X6 RS-485 (for internal use)	10	U4 SW parallel CAN for the terminating resistors
3	X6 REPO port	11	U4 parallel communication port
4	X6 J3: BCB and I/O dry contact ports	12	X7 J3: Other programmable output dry contact port
5	X6 J22: Backfeed port	13	X7 J2: I/O dry contact ports
6	Vertiv™ Liebert® IntelliSlot™ 1	14	X7 J1: BCB and I/O dry contact ports
7	Liebert® IntelliSlot™ 2	15	X6 HMI port
8	Screw (quantity is 8)	16	X6 BATT: Battery temperature or BMS communication port

NOTE: The screws should be tightened after each board is inserted, as shown in **Figure 4.7** above, to maintain proper grounding.

4.2.2 Dry Contact Port X6 J3

The schematic diagram of dry contact port J3 is shown in **Figure 4.8** on the next page and the ports are described in **Table 4.7** on the next page. The input dry contacts of this series provide 24 V/10 mA signals, and the output dry contacts are relay contacts that can accept 24 V/1 A signals. The BCB drive signal can provide 12 V/10 mA signal.

Figure 4.8 Dry Contact Port J3

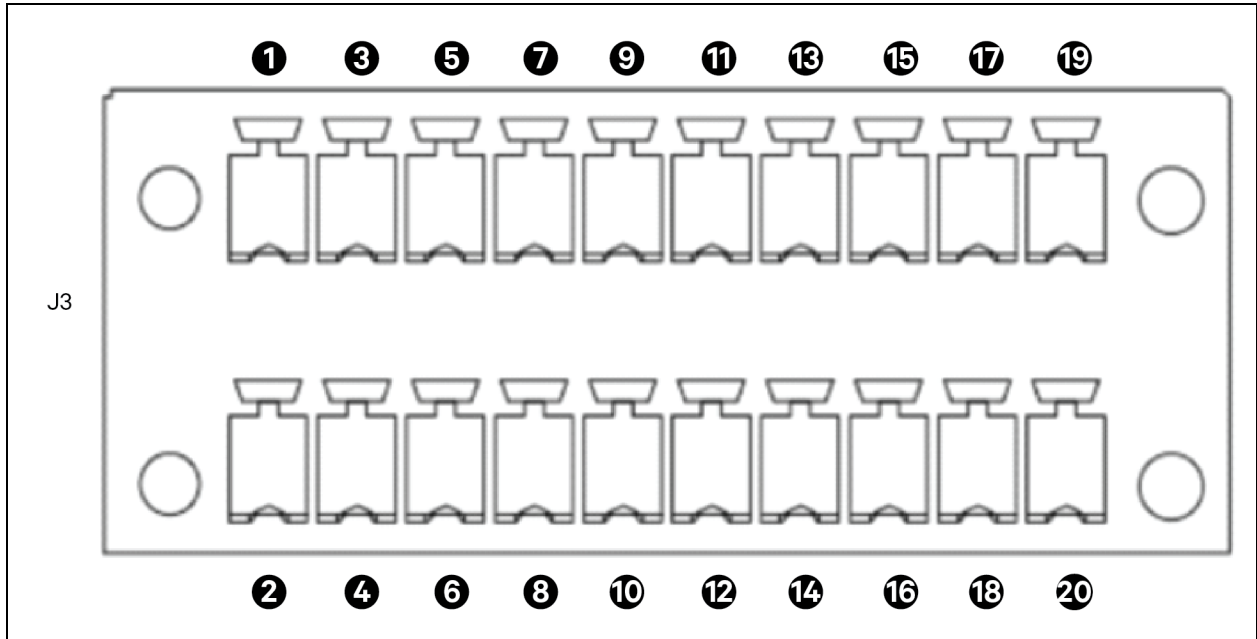

Table 4.7 Description of Dry Contact Port J3

Pin	Name	Meanings	Pin	Name	Meanings
1	Dry in	Input dry contact can be defined, the default setting is BCB power abnormal, NC contact.	2	NA	Reserved
3	GND		4	Dry in	Input dry contact can be defined, the default setting is BCB1 status, branch BCB online dry contact free to enable.
5	Dry in	Input dry contact can be defined, the default setting is charger off.	6	GND	
7	GND		8	Dry in	Input dry contact can be defined, the default setting is BCB5 status.
9	NO	Output dry contact can be defined, the default setting is BCB1&5 trip.	10	GND	
11	Com1		12	Dry in	Input dry contact can be defined, the default setting is battery grounding signal.
13	NC	14	GND		
15	NO	Output dry contact can be defined, the default setting is BCB2&6 trip.	16	PE	Shielding to PE
17	Com1		18	CAN+	CAN bus (reserved), set the matching resistor to PIN2 of SW1.
19	NC		20	CAN-	

NOTE: The BCB drive signal and external battery temperature signal must be carried through shielded cables, and both sides of the shielding coat must be securely connected to the enclosure.

The list of definable input dry contact described in **Table 4.8** on the facing page.

Table 4.8 Input Dry Contact Functions

Number	Function Description	Number	Function Description
1	External switch status (optional mains input/bypass input/external output/external maintenance bypass/load switch)	10	BCB tripping required
2	Turn off the inverter	11	Charger off
3	BCB enabled (8-group settable)	12	Start battery manual test
4	BCB feedback status (8-group settable)	13	Stop battery manual test
5	Fault clear	14	Generator mode
6	Battery system abnormal	15	Eco mode paused
7	Battery system fault	16	Battery grounding fault (8-group settable)
8	Battery low voltage	17	BCB power abnormal
9	Battery room over temperature		

The list of definable output dry contact functions is described in **Table 4.9** below.

Table 4.9 Output Dry Contact Functions

Number	Function Description	Number	Function Description
1	UPS alarm	6	On maintenance bypass
2	UPS fault	7	Input voltage abnormal
3	On inverter	8	Battery low voltage
4	On battery	9	BCB trip
5	On bypass		

The schematic diagram of dry contact port J22 is shown in **Figure 4.9** on the next page and described in **Table 4.10** on the next page. The dry contact voltage/current is 24 VDC / 250 VAC, and the current is 5 A.

Figure 4.9 Dry Contact Port J22

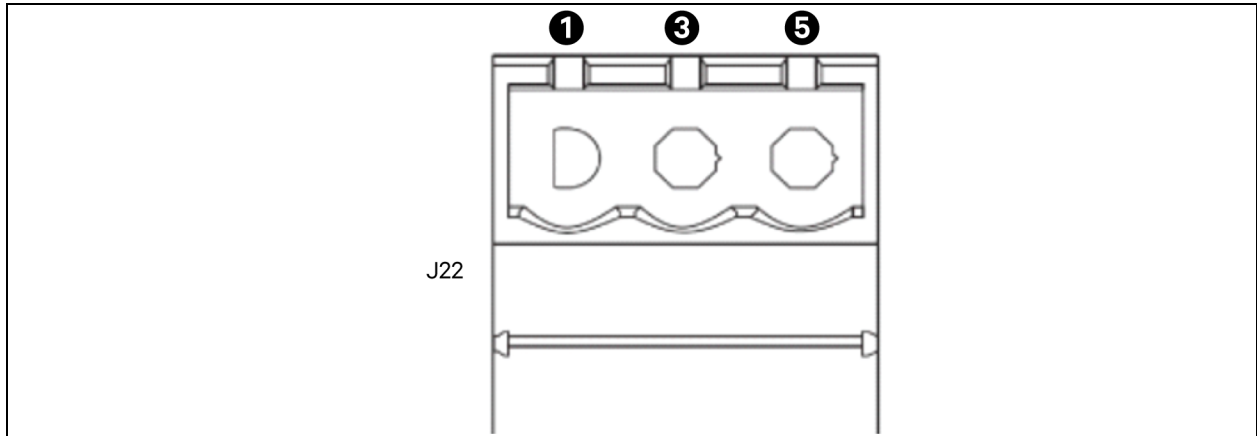

Table 4.10 Description of Dry Contact Port J22

Port	Pin	Name	Meanings
Bypass Backfeed	J22-1	BFP_O	Normally open. Closed when bypass has backfeed
	J22-3	BFP_S	Bypass backfeed protection relay common
	J22-5	BFP_C	Normally closed. Open when bypass has backfeed

4.2.3 Output Dry Contact X7 J1 (Option)

The schematic diagram of output dry contact port J1 is shown in **Figure 4.10** on the facing page and described in **Table 4.11** on the facing page. The input dry contacts of this series provide 24 V/10 mA signals, and the output dry contacts are relay contacts that can accept 24 V/1 A signals. The BCB drive signal can provide 12 V/10 mA signal.

Figure 4.10 Dry Contact Port J1

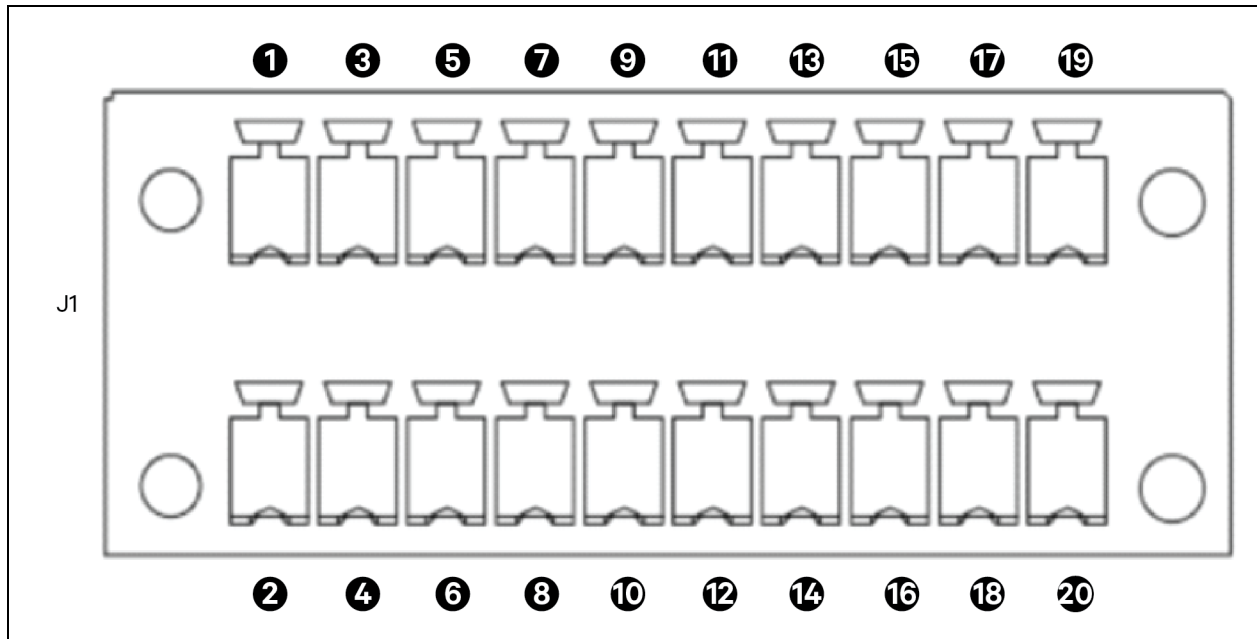

Table 4.11 Description of Dry Contact Port J1

Pin	Name	Meanings	Pin	Name	Meanings
1	NA	Reserved	2	NA	Reserved
3	NA		4	NA	
5	Dry in	Input dry contact can be defined, the default setting is BCB2 status feedback, NO contact.	6	Dry in	Input dry contact can be defined, the default setting is BCB3 status feedback, NO contact.
7	GND		8	GND	
9	Dry in	The input dry contact can be defined, and the default setting is BCB6 status feedback, NO contact.	10	Dry in	The input dry contact can be defined, and the default setting is BCB7 status feedback, NO contact.
11	GND		12	GND	
13	Dry in	The input dry contact can be defined, and the default setting is to turn off the inverter	14	Dry in	The input dry contact can be defined, and the default setting is the state of the external output switch MOB/QE
15	GND		16	GND	
17	Dry in	The input dry contact can be defined, and the default setting is the maintenance switch MBB/QBP state	18	Dry in	The input dry contact can be defined, and the default setting is the state of the system total output switch MIB/QOP
19	GND		20	GND	

NOTE: The programmable dry contacts must be set in **Paramset**.

When using a parallel system, if you want to use the dry contact function of the external maintenance isolation circuit breaker, the auxiliary contact signal must be connected to the respective dry contacts on all single racks in the parallel system at the same time.

4.2.4 Output Dry Contact X7 J2 (Option)

The schematic diagram of the output dry contact port J2 is shown in **Figure 4.11** on the next page and described in **Table 4.12** on the next page. The input dry contacts of this series provide 24 V/10 mA signals, and the output dry contacts are relay contacts that can accept 24 V/500 mA signals. The BCB drive signal can provide 12 V/10 mA signal.

Figure 4.11 Dry Contact Port J2

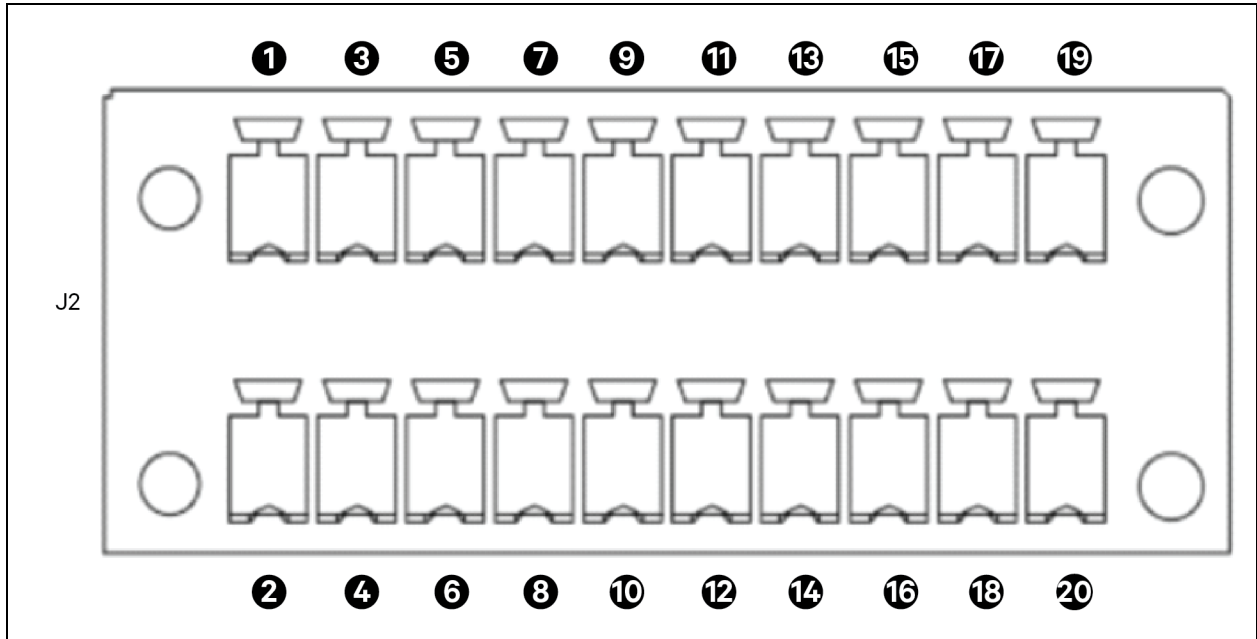

Table 4.12 Description of Dry Contact Port J2

Pin	Name	Meanings	Pin	Name	Meanings
1	Dry in	The input dry contact can be defined, and the default setting is the load test switch LLBB state.	2	NA	Reserved
3	GND		4	NA	
5	Dry in	The input dry contact can be defined, and the default setting is the state of the main input switch RIB/Q1.	6	Dry in	The input dry contact can be defined, and the default setting is BCB4 status feedback, NO contact.
7	GND		8	GND	
9	NO	The output dry contact can be defined, and the default setting is BCB3&7 trip.	10	Dry in	The input dry contact can be defined, and the default setting is BCB8 status feedback, NO contact.
11	COM		12	GND	
13	NC		14	Dry in	
15	NO	The output dry contact can be defined, and the default setting is BCB4&8 trip.	16	GND	NA
17	COM		18	NA	
19	NC		20	GND	

NOTE: The programmable dry contacts must be set in Paramset.

When using parallel system, if you want to use the dry contact function of the external maintenance isolation circuit breaker, the auxiliary contact signal must be connected to the respective dry contacts on all single racks in the parallel system at the same time.

4.2.5 Output Dry Contact X7 J3 (Option)

The schematic diagram of output dry contact interface J3 is shown in **Figure 4.12** on the facing page and described in **Table 4.13** on the facing page. The dry contact voltage/current rating is 24 VDC/250 VAC, and the current is 5 A.

Figure 4.12 Dry Contact Port J3

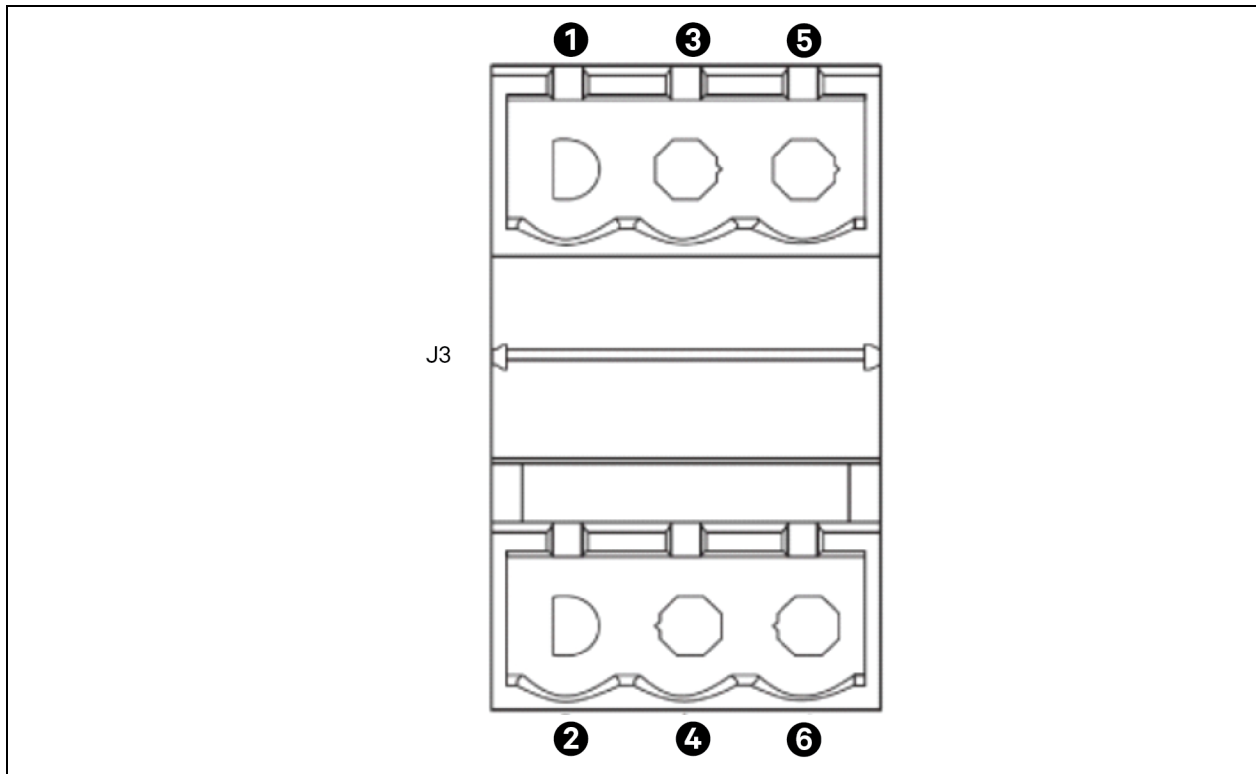

Table 4.13 Description of Dry Contact Port J3

Port	Pin	Name	Default Signal
BCB trip energy	J3-1	NO	Normally open. External maintenance bypass MBB and system inverter main switch MIB interlock signal.
	J3-3	COM	Common contact
	J3-5	NC	Normally closed
ATS transfer enable signal	J3-2	NO	Normally open. Provide remote dry contact signal to enable upstream ATS switching.
	J3-4	COM	Common contact
	J3-6	NC	Normally closed

NOTE: X7 J3 pins are programmable contacts.

4.2.6 Remote Emergency Power Off Port

The UPS consist of an remote emergency power off (REPO) function that operates by either an REPO button on the touchscreen of the UPS or a remote contact provided by the user. The REPO button has a protective cover.

Within 328.08 ft. (100 m) of the communication line, use a shielded wire, and both ends of the shielded wire are grounded. If the length exceeds 328.08 ft. (100 m), the shielded wire must go through a metal pipe.

The schematic diagram of the REPO port is shown in **Figure 4.13** on the next page and described in **Table 4.14** on the next page.

Figure 4.13 Remote Emergency Power Off Port

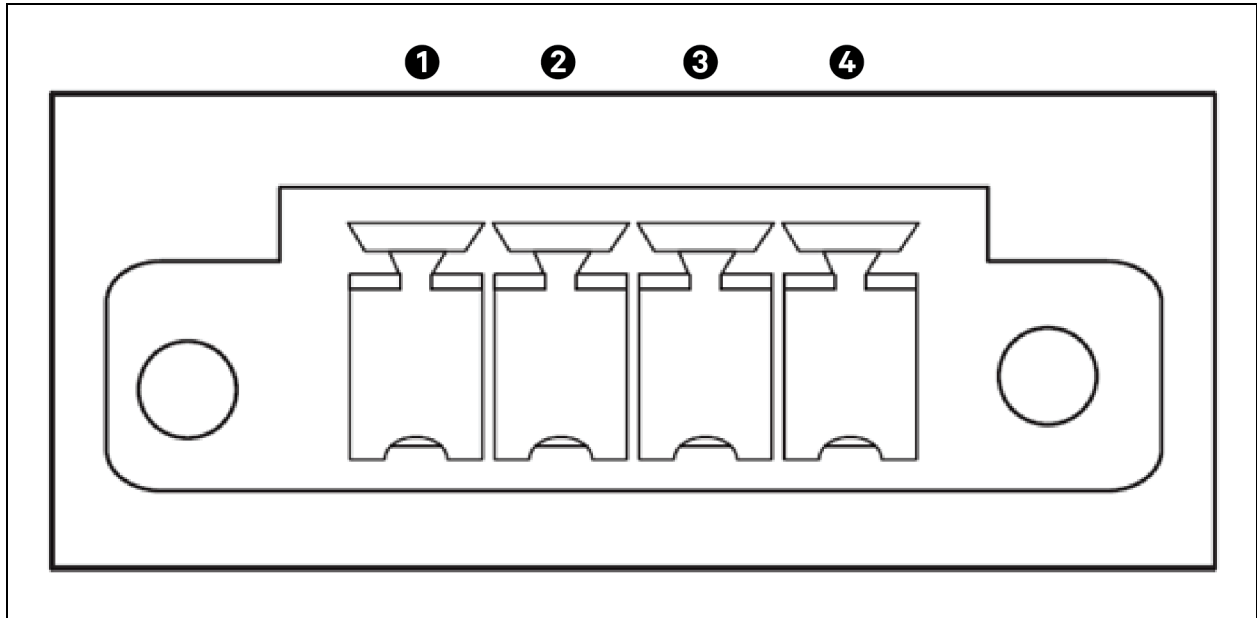

Table 4.14 Remote Emergency Power Off Port Pins

Pin	Name	Meanings
1	EPO-NC	REPO activated when opened to Pin 2.
2	+ 12 V	REPO activated when opened to Pin 1.
3	+ 12 V	REPO activated when shorted to Pin 4.
4	EPO-NO	REPO activated when shorted to Pin 3.

The REPO is triggered when the pins 3 and 4 are shorted or the pins 2 and 1 are opened.

If an external REPO function is required, pins 1 and 2 or 3 and 4 are reserved for this function. The external REPO facility is also connected to the normally open or normally closed REPO switch between these two terminals using shielded cable. If this function is not required, pins 3 and 4 must be opened and pins 1 and the 2 must be closed.

NOTE: The REPO action of the UPS shuts down the rectifier, the inverter, and the static bypass, but it does not internally disconnect the mains input power supply. To disconnect all power to the UPS, open the external power switch, bypass input switch, output switch and BCB after the REPO is activated.

4.2.7 Parallel and LBS Communication Ports

See Figure 4.7 on page 45 for the positions of the parallel and LBS communication port.

4.2.8 Vertiv™ Liebert® IntelliSlot™ Port

The Vertiv™ PowerUPS 9000 1250 kVA Modular UPS consist of two IntelliSlot ports which allows field installation of the optional communication cards, including IS-UNITY-DP card, and IS-Relay card. Table 4.15 on the facing page describes the models and installation positions of the optional cards. For the detailed installation of the optional cards, see the respective contents in the [Vertiv™ PowerUPS 9000 1250 kVA Modular UPS Option Configurations](#) on page 105.

Table 4.15 Models and Installation Positions of Optional Cards

Optional Card	Model	Installation Position
IS-RELAY	IS-RELAY	Vertiv™ Liebert® IntelliSlot™ ports 1 to 2
RDU120 card	RDU120	Liebert® IntelliSlot™ ports 1 to 2

NOTE: When using the RDU 120 card, it is necessary to set the IS RS-485 Bus protocol to Velocity on the human machine interface (HMI).

NOTE: The RDU120 card can be inserted in either Liebert® Intellislot™ 1 or 2, or both. If you use the card simultaneously, you need to reset the node code of the second card. When using, it is necessary to set the protocol of IS RS-485 bus to Velocity.

4.2.9 Signal Cable Connection Steps

Top cable access and bottom cable access are available for 1250 kVA UPS. See **Figure 4.14** on the next page and **Figure 4.15** on page 55 for the cabling route and then connect signal cables to corresponding ports shown in **Figure 4.7** on page 45.



WARNING! Risk of electric shock. Can cause equipment damage, personnel injury, or death. Verify that all external and internal power switches of the UPS are turned off and locked out or tagged out before installing the cables or making any electrical connections. Also, measure the voltages between the UPS terminals and the voltages between the terminals and the earth.

NOTE: The power cables and signal cables should be routed respectively. The shielding coat of signal cable must be reliably earthed.

Figure 4.14 Signal Cables Wiring Route of 1250 kVA (Top Cable Access)

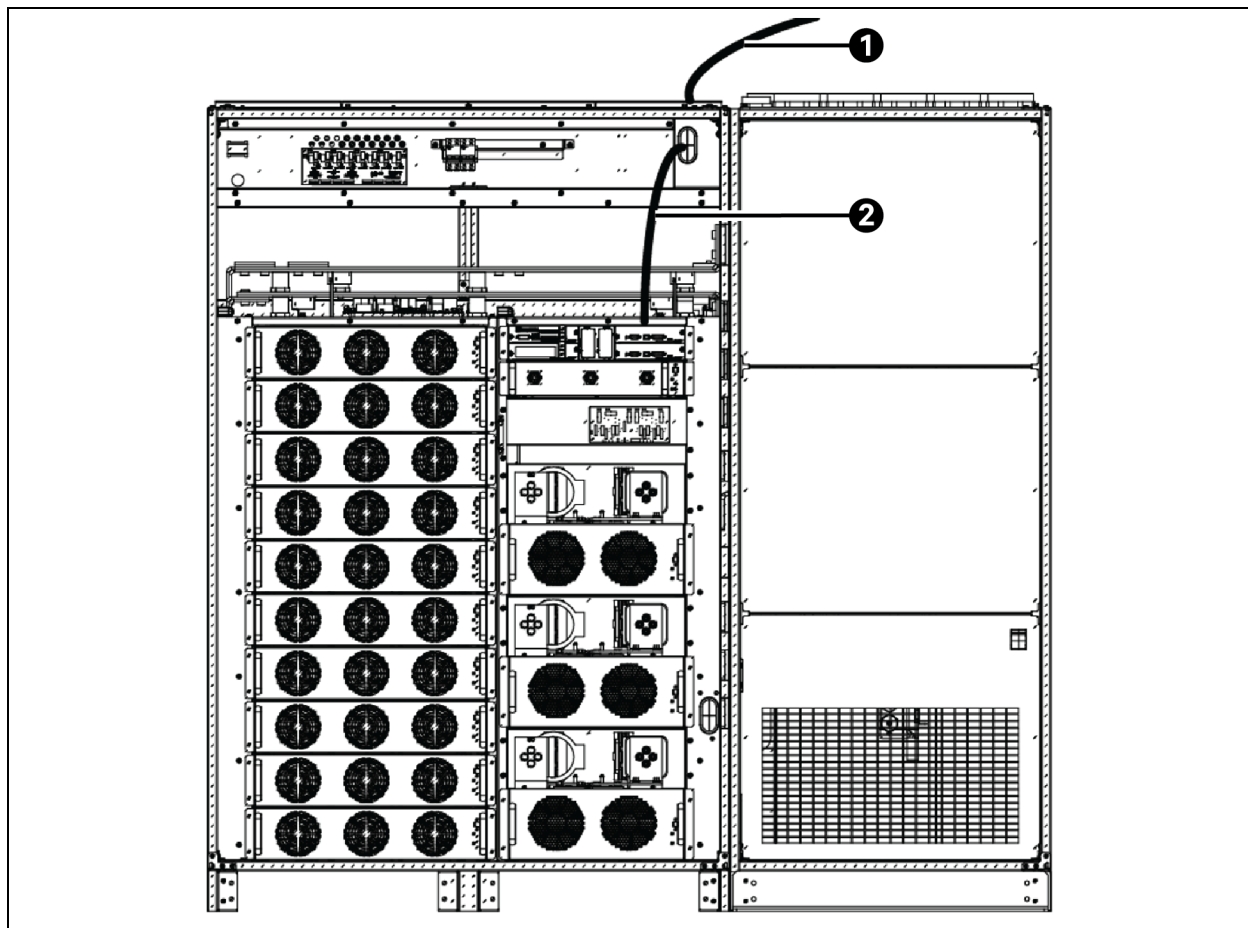

Item	Description
1	Lead the signal cables into the cabinet through this cabling entry plate.
2	Connect them to corresponding terminals.

Figure 4.15 Signal Cables Wiring Route of 1250 KVA (Bottom Cable Access)

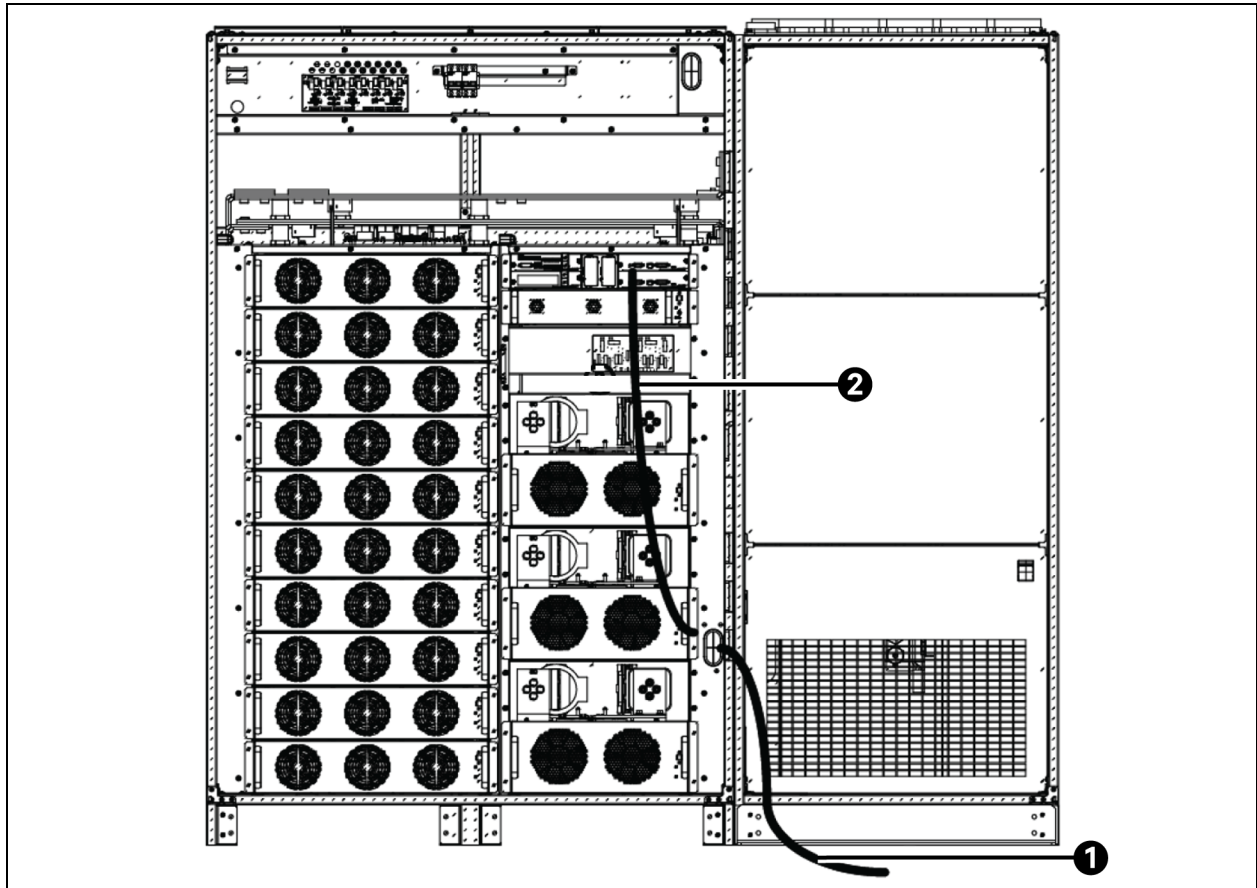

Item	Description
1	Lead the signal cables into the cabinet through this cabling entry plate.
2	Connect to corresponding terminals.

This page intentionally left blank

5 Operator Control and Display Panel

5.1 Introduction

The integrated display of touchscreen control panel of the UPS simplifies monitoring and managing single or multiple Vertiv™ Liebert® UPS modules. The control collects information about the health of the modules and presents it in a standardized format. This simple, dynamic display speeds operator response to changing power input and demand.

Most of the settings depend on the UPS type and features. Other settings will be made during the UPS setup by Vertiv service personnel. The Vertiv™ PowerUPS 9000 1250 kVA Modular UPS touchscreen control panel display shows data either graphically or as text. The status scroll bar at the top of the touchscreen shows the system conditions. The bar changes color to indicate status and includes an icon matched to the status. The Status Gauge displays details as power demand from the connected load, input power quality, output and bypass on each phase and battery capacity.

5.2 Navigating through the PowerUPS 9000 1250 kVA Modular UPS Touchscreen

The PowerUPS 9000 1250 kVA Modular UPS touchscreen control panel is active when the UPS has input power. The touchscreen on the front of the UPS permits:

- Login Capability. See [Login](#) on page 59 for more information.
- Silencing alarms. See [Silence an Alarm](#) on page 62 for more information.
- Turning the UPS On. See [Inverter On](#) on page 62 for more information.
- Turning the UPS Off. See [Inverter Off](#) on page 62 for more information.
- Resetting faults. See [Reset Fault](#) on page 63 for more information.
- Enabling energy saving mode. See [Energy Saving Mode Activation](#) on page 64 for more information.

To check the status of the UPS and its external batteries, including all measured parameters, events, and alarms, see [Viewing UPS Status](#) on page 66 and viewing UPS component status.

The PowerUPS 9000 1250 kVA Modular UPS touchscreen control panel's display default view is two panes. One line graphic screen and unit status. The appearance can be changed to multiple panes that show other data. Customizing the appearance is detailed in customizing the display.



CAUTION: Risk of unauthorized changes to operational settings. Can cause equipment damage. The default PIN numbers should be changed immediately to prevent unauthorized personnel from changing UPS operation or even shutting down the UPS. The PINs for Operator and Administrator may be changed by logging in with either Administrator or Service level access.

5.2.1 Vertiv™ PowerUPS 9000 1250 kVA Modular UPS Touchscreen Control Panel Components

The main areas of the PowerUPS 9000 1250 kVA Modular UPS touchscreen control panel are shown in **Figure 5.1** below and **Figure 5.2** on the facing page. The display arrangement and the information displayed can be changed. At login for all access levels, the PowerUPS 9000 1250 kVA Modular UPS touchscreen control panel opens to the Status screen in graphic display. The Status screen will show the graphic screen and system status readings at each login level. The appearance will differ only in the function menus displayed, as shown in **Figure 5.3** on page 60.

Figure 5.1 Touchscreen Control Panel Components

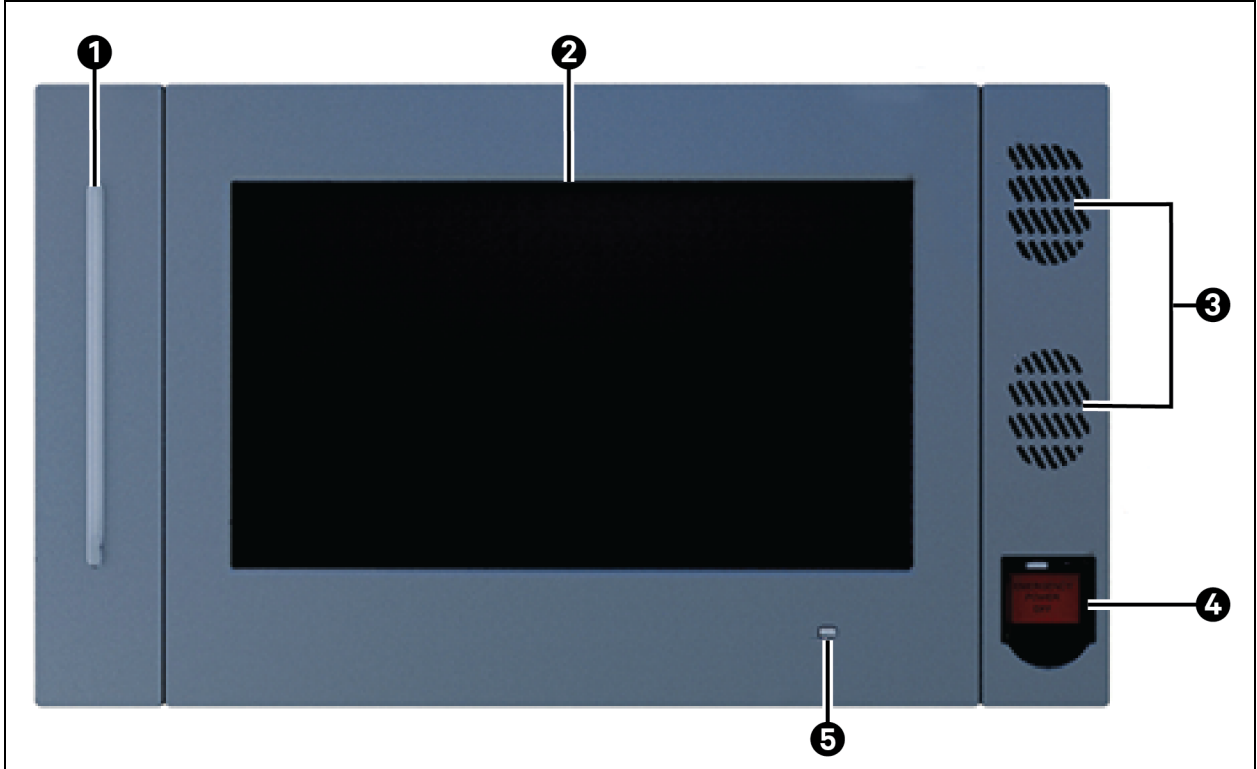

Item	Description	Item	Description
1	UPS Status LED	4	Remote EPO Switch
2	Touchscreen LCD	5	UPS Status LED
3	Speakers (not used)		

Figure 5.2 Interface Overview — Status Screen Graphic Display

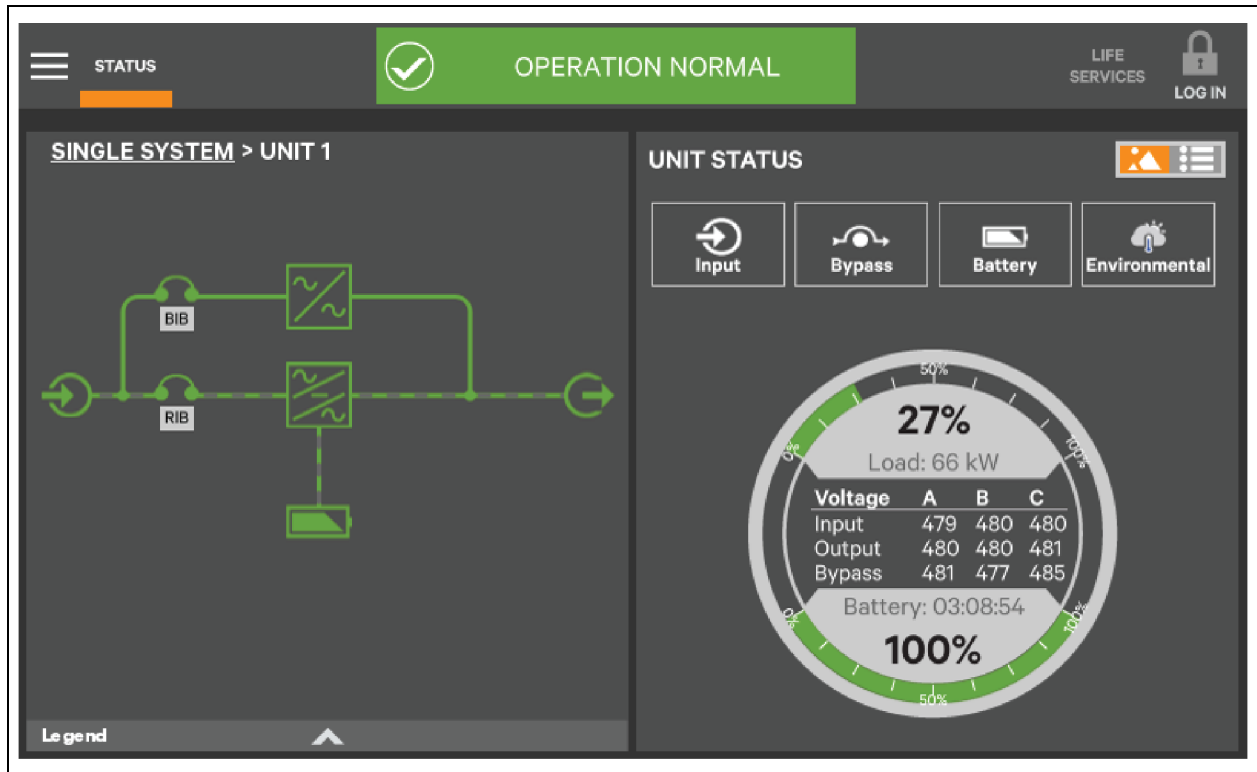

Information and control are different under each Function Menu. The Function Menus displayed are specific to the access level.

- **Status:** Condition of the UPS components and data affecting operation and performance. Visible to all access levels.
- **Operate:** UPS operation controls, such as inverter on, inverter off, energy saving status. Visible to Operator, Administrator and Service.
- **Setup:** Manage permissions through PINs. Visible to Administrator and Service.
- **Service:** Input wiring and breaker configuration, protocol used. Visible to Service.

5.3 Operation

5.3.1 Login

The Vertiv™ PowerUPS 9000 1250 kVA Modular UPS touchscreen control panel provides security by limiting the authority to change how the UPS operates. The 4 access levels offer different authority:

- **Observer:** Viewing permission only; can choose graphic or text display. No PIN is required.
- **Operator:** Permission to start the UPS, shut the system down, reset faults and enable or disable Eco Mode operation. PIN is required.
- **Administrator:** All functions of Operator plus permission to change PINs for Operator and Administrator level. PIN is required.
- **Service:** All functions of Administrator plus permission to alter system configuration, choose serial communication protocol, enable equalize battery charging and change Service PIN. PIN is required.

Vertiv™ Liebert® Tech Services provide PINs when setting up the UPS. These default PINs may be changed by those with Administrator or Service access.

Default PINs are:

- **Operator:** 1234



CAUTION: Risk of unauthorized changes to operational settings. Can cause equipment damage. The default PIN numbers should be changed immediately to prevent unauthorized personnel from changing UPS operation or even shutting down the UPS. The PINs for Operator and Administrator may be changed by logging in with either Administrator or Service level access.

The Vertiv™ PowerUPS 9000 1250 kVA Modular UPS touchscreen control panel is on when the UPS has control power. It is inactive and appears dark, depending on its settings. Touch the touchscreen to turn it on.

To log in to the PowerUPS 9000 1250 kVA Modular UPS touchscreen control panel:

1. Touch the Log In icon at the top right of the screen. The lock and background change color a prompt, PIN required screen, is displayed.
2. Enter a PIN at the prompt using the keypad on the touchscreen.
3. Touch Enter.

NOTE: If you enter an incorrect PIN, a prompt stating the PIN is invalid is displayed.

Figure 5.3 Log In Screen

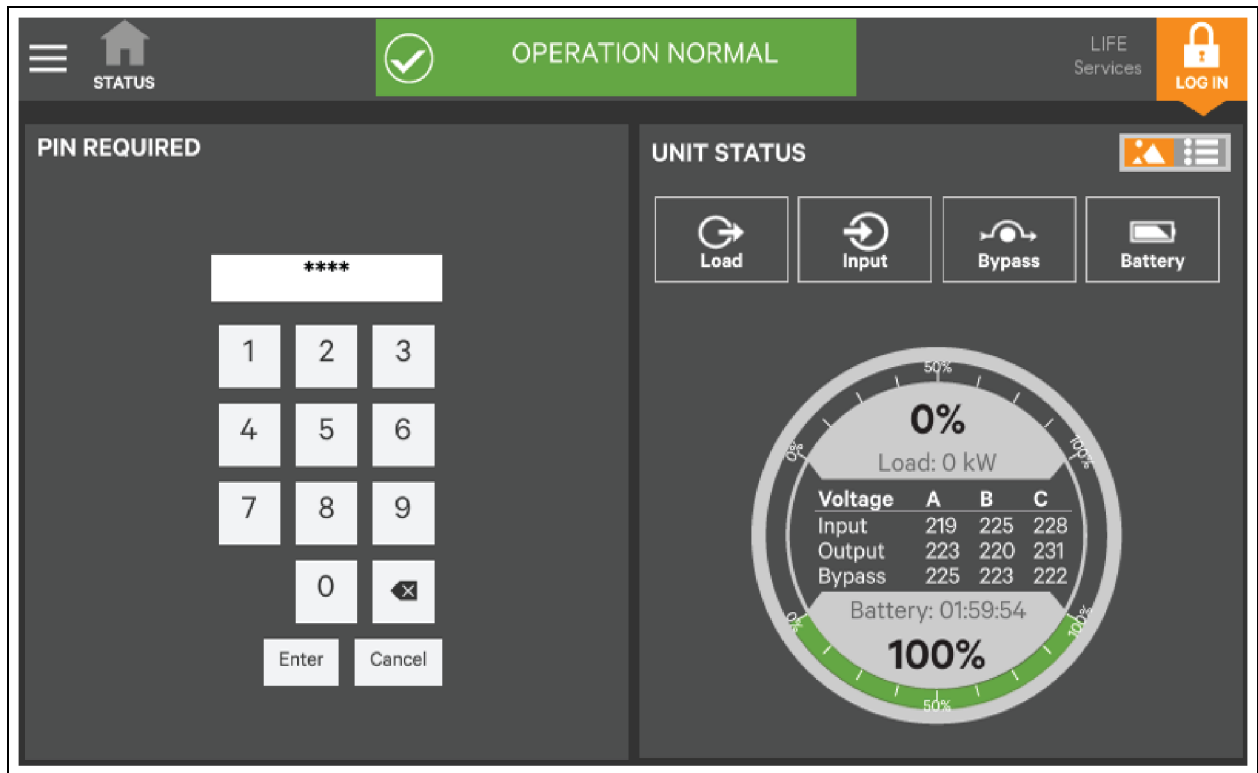

5.3.2 Operator Controls

The Operator login enables control of UPS functions:

- Silence (Alarm)
- Inverter On
- Inverter Off
- Reset Fault
- Energy Saving Mode Activation

Each command is available under the Operate menu. The Operate menu may be used by logging in with Operator, Administrator, and Service access.

Operate menu commands

All Operator commands are available from the Operate menu. The menu is available when the UPS has input power. The UPS need not be supplying power to the load for the menu to be available. The graphic screen is not linked to data in this view—touching a component will not cause it to display data.

Figure 5.4 Operate Menu

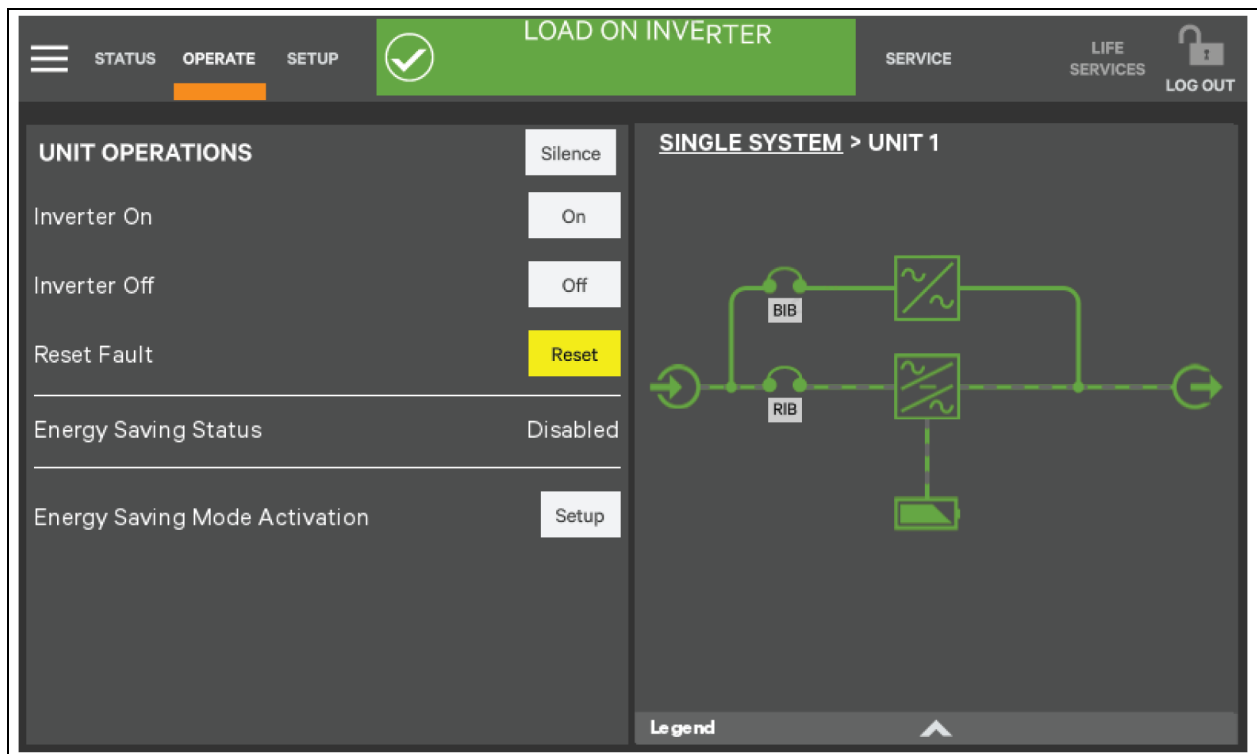

CAUTION: Risk of improper operation. Can cause load drop resulting in equipment damage. The Inverter On, Inverter Off, Reset Fault and Energy Saving Mode Activation commands will be available whenever the UPS is operating. Before executing any command, verify that the UPS status is suitable for the command to be performed.

Silence an Alarm

To silence an alarm, touch the Silence button at the top of the panel. The time the alarm will remain silenced varies, depending on the UPS type, type of alarm, and configuration.

Inverter On

The Inverter On menu item is available when the UPS has input power, and the inverter is off. Before executing the command, verify that the UPS is prepared for the inverter to start. When the operator access is shown, commands are the same for all access levels. The Vertiv™ PowerUPS 9000 1250 kVA Modular UPS touchscreen control panel displays a message asking for confirmation. Touch On to confirm, see **Figure 5.5** below. The control then displays a progress window while the inverter starts.

Figure 5.5 Inverter On Screen

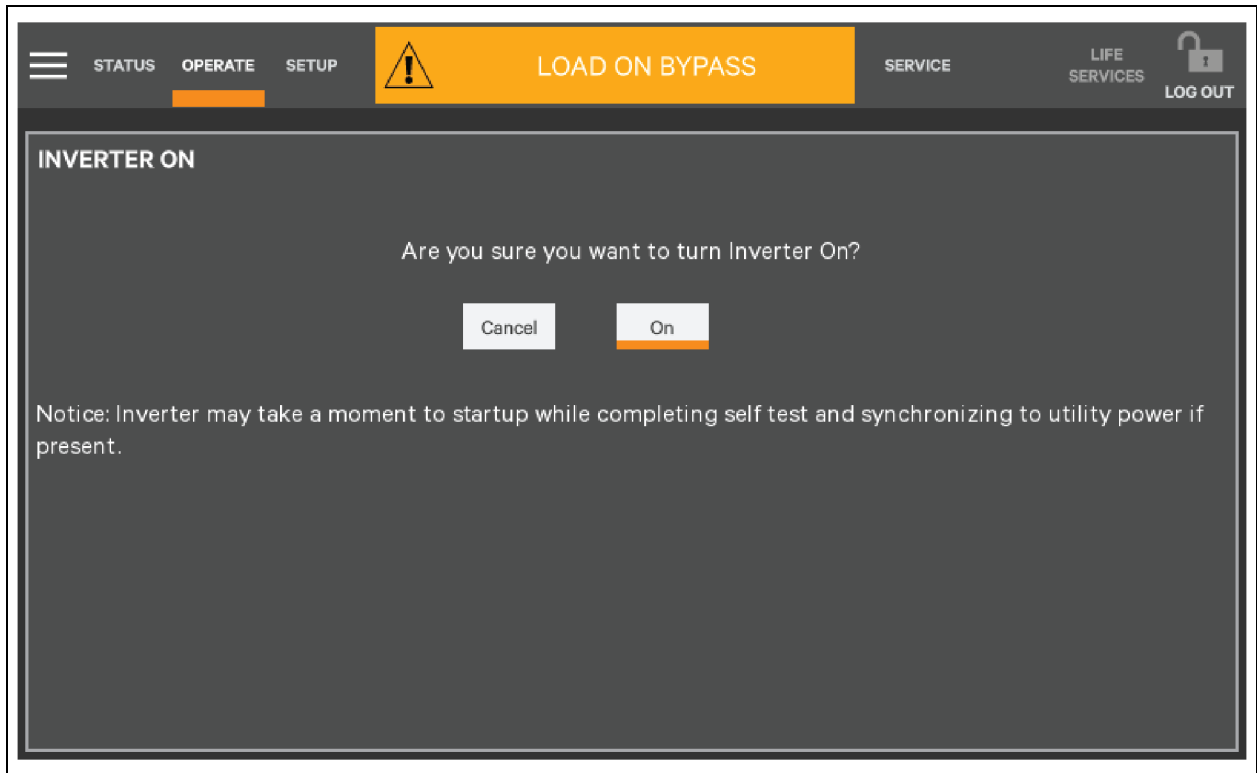

Inverter Off

The Inverter Off menu item is available whenever the UPS has input power and the inverter is on. Before executing the command, verify that the UPS and connected load are prepared for the inverter to be shutdown. Touch Off to turn the inverter Off.



CAUTION: Risk of improper operation. Can cause load drop resulting in equipment damage. The Inverter Off will shut off power to the connected load unless bypass power is available. Before executing this command, verify that the connected load is either shut off or that input power to the load will be supplied by another source, such as bypass.

Figure 5.6 Inverter Off Screen

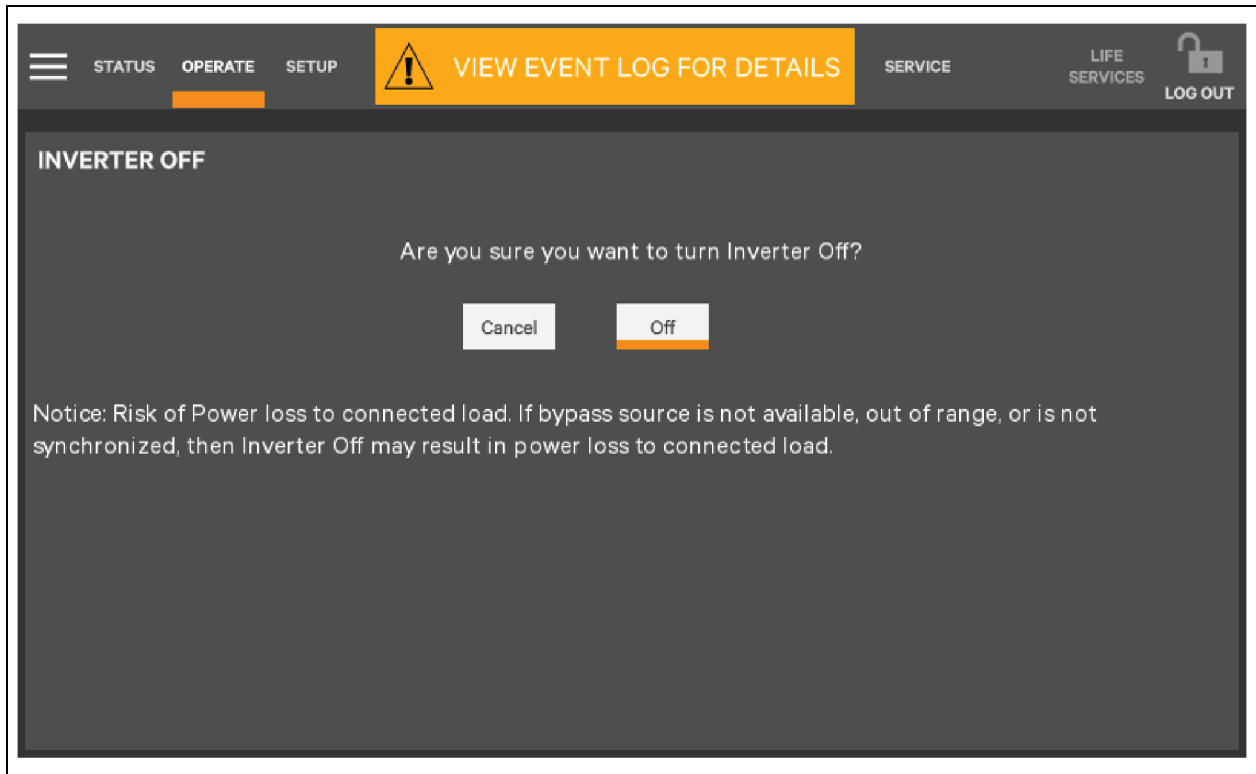

Reset Fault

Reset faults by touching the Reset button.

Figure 5.7 Reset Fault Screen

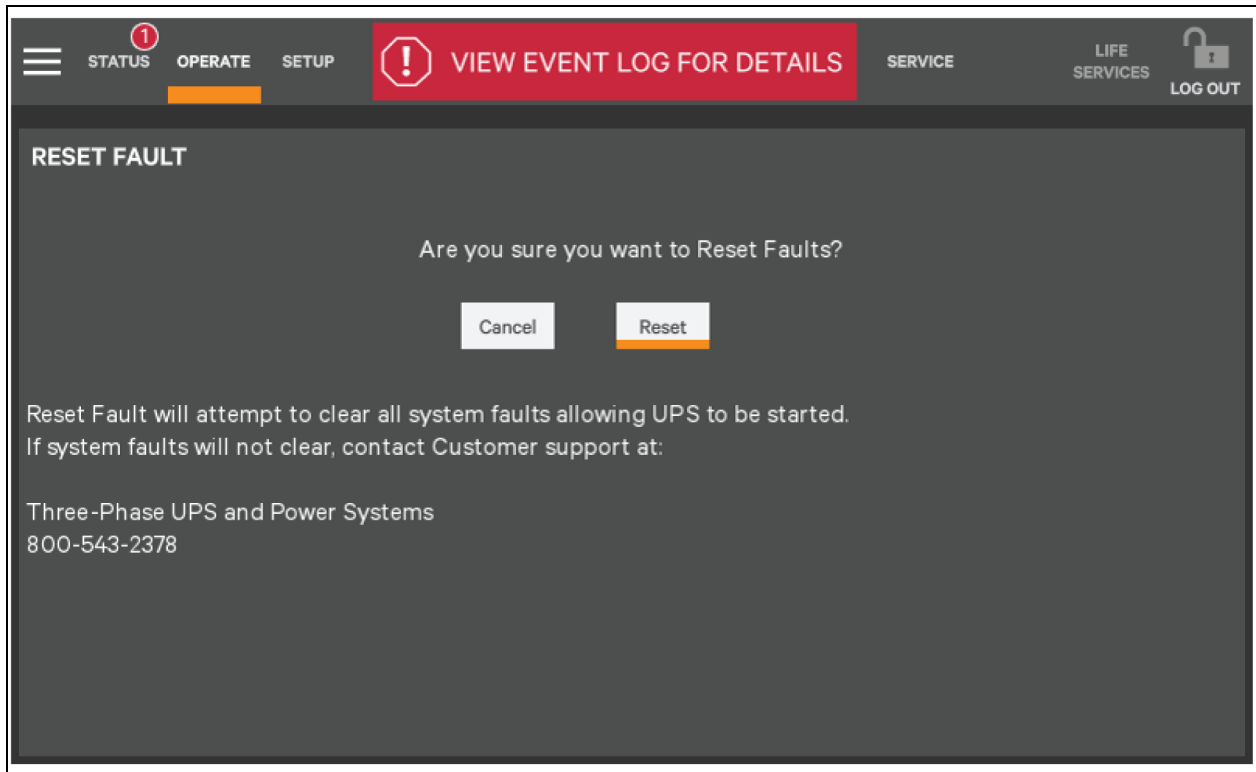

Energy Saving Mode Activation

NOTE: Read this manual carefully before activating Energy Saving Mode. Only an Operator enable or disable Energy Saving Mode. The available modes vary according to the UPS type and system configuration. The types available must be set up by either Administrator or Service personnel.

Energy Saving Mode may be activated or deactivated through the Operate menu screen. Two modes are available as Eco mode and intelligent parallel mode.

Eco Mode permits the UPS to reduce power consumption by powering the load through bypass power when utility supplied power is within acceptable ranges. The inverter will remain in a state that will permit it to resume supplying power if the utility power goes outside acceptable ranges.

Intelligent paralleling puts units in sleep mode until required.

To activate or deactivate Energy Saving Mode:

1. Touch the Setup button for Energy Saving Mode Activation.
2. Enable or disable Energy Saving Mode.
3. Touch the Save button. The Save button is inactive until the activation state is changed.

Figure 5.8 Activating Energy Saving Mode

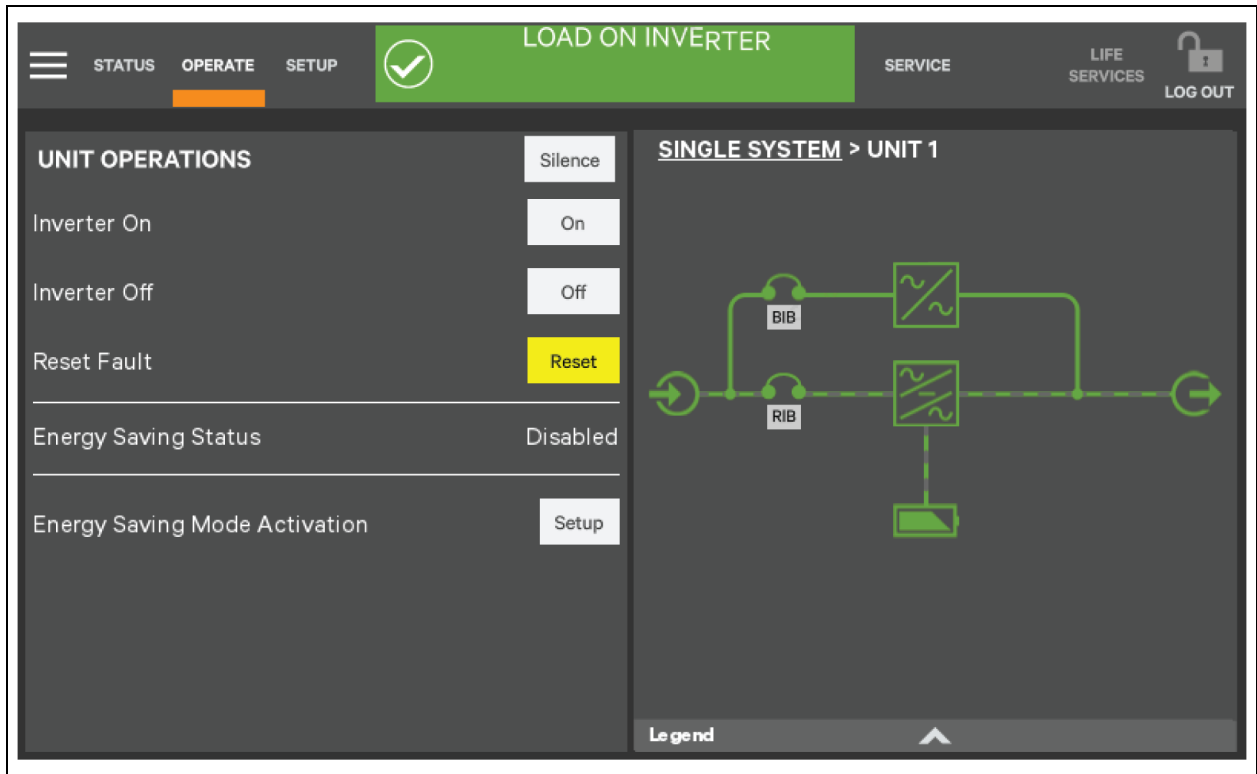
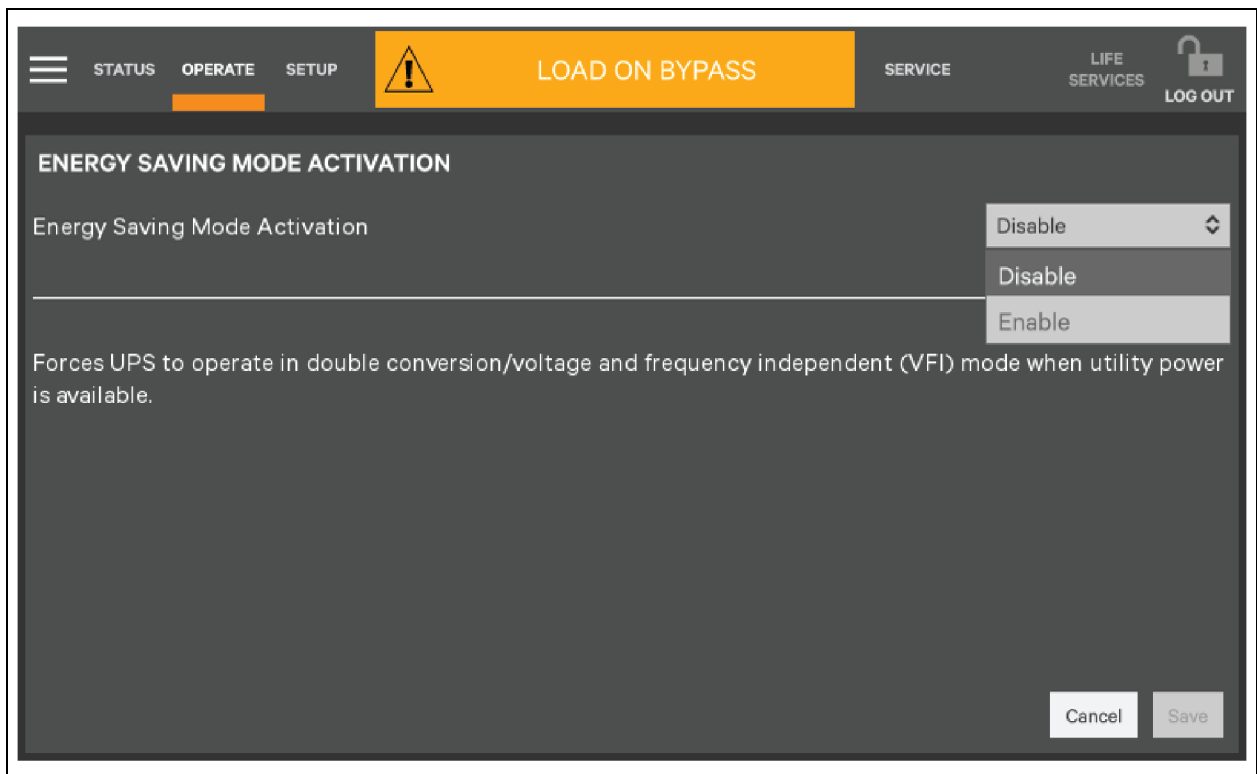

Figure 5.9 Energy Saving Mode Activation



5.4 Viewing UPS Status

The Vertiv™ PowerUPS 9000 1250 kVA Modular UPS touchscreen display reports UPS status in multiple ways. The graphic views and text views will show the same readings.

5.4.1 Status Bar Component

The status bar indicates UPS status by:

- Changing color. Color indicators are green for normal, yellow for warning, and red for alarm.
- Showing an icon inside the bar. See **Figure 5.10** below.

Figure 5.10 Status Bar Messages



Up to three messages may scroll through the status bar to the right of the status icon. Each message will have a duration of 4 seconds, except they change immediately if the system's status changes.

Alarms and certain events will trigger audible alarms and the LED on the bezel, the light bar and the status header will change color. (Audible alarms do not sound unless enabled.) For more information on how to enable the audible alarms, see **Figure 5.11** below. The scrolling information bar at the top of the interface summarizes information about the UPS status. The Status Gauge on the Unit Status pane gives additional details about the UPS status.

Figure 5.11 Audible Alarms Enable View

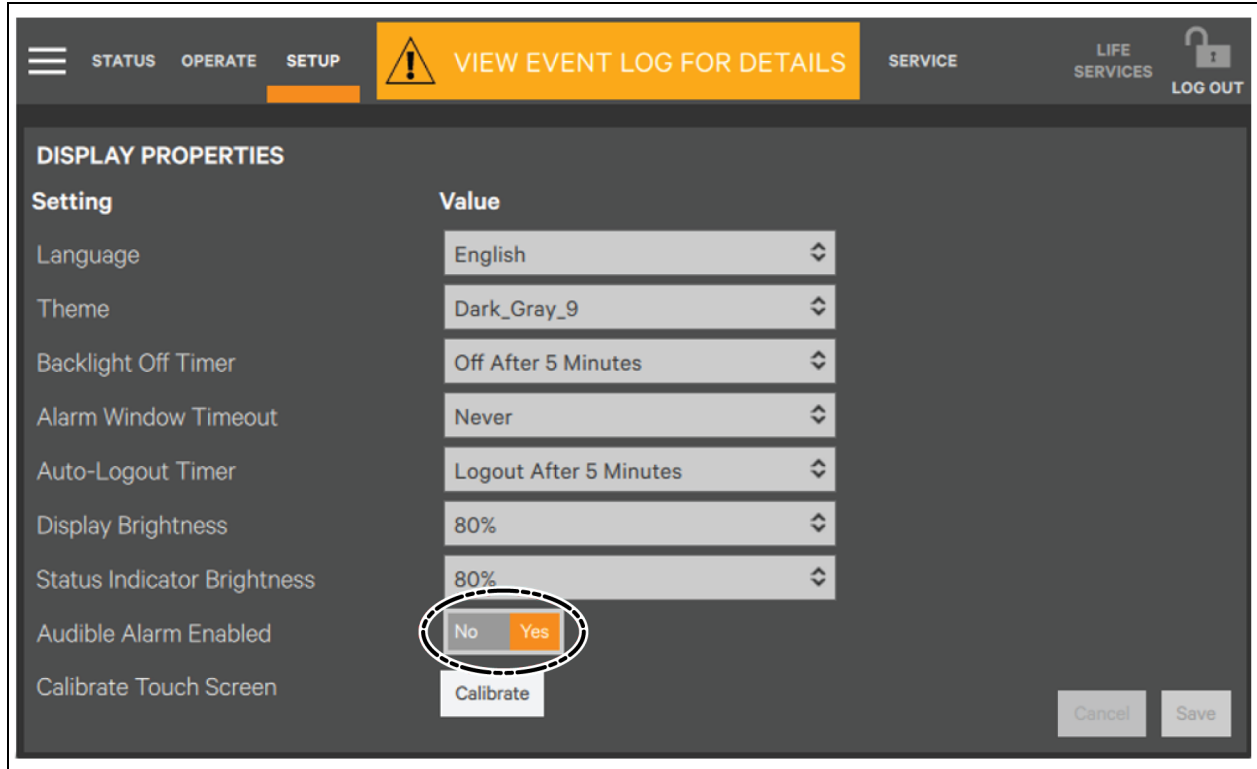

5.4.2 Viewing UPS Data with the Status Gauge

The Status Gauge offers a quick summary of the UPS status. The information shown depends on the type of UPS and its configuration and upon the choices made in the gauge setup. The data can be chosen by someone with Administrator or Service access.

The additional data will not replace the information shown in the center of the Status Gauge. Touching the center of the Status Gauge multiple times on will cycle through the data.

Figure 5.12 Default Status Gauge View

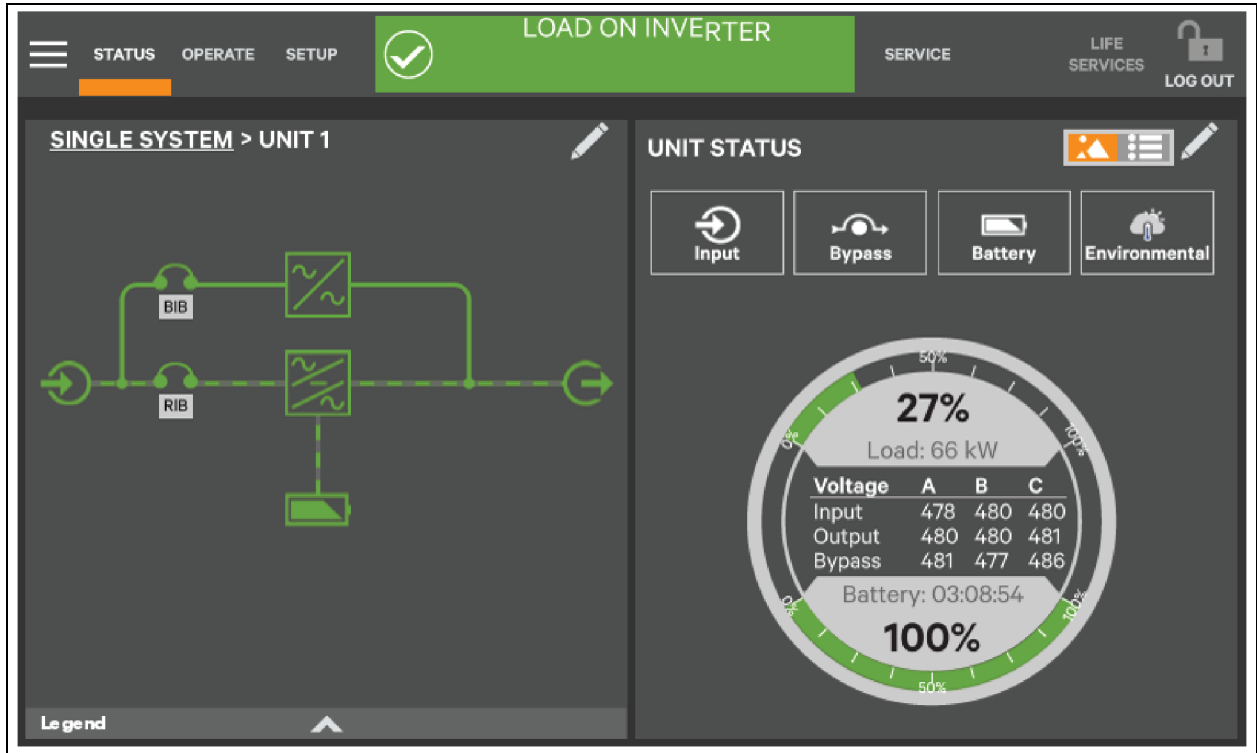

5.4.3 Viewing UPS Data with the Status Panel

More detailed information about the UPS status is readily available through the Status panel. Touching a component in the graphic screen display brings up data about the component on another pane. Touching a parameter icon on the Unit Status pane shows details about that parameter.

The same data can be viewed by switching to the text view. The length of the lists and order of the details may require scrolling to find the desired data.

NOTE: A parameter must be visible on the graphic view of the Unit Status screen for details to be viewed, even in the text view.

Figure 5.13 Unit Status — Input Details

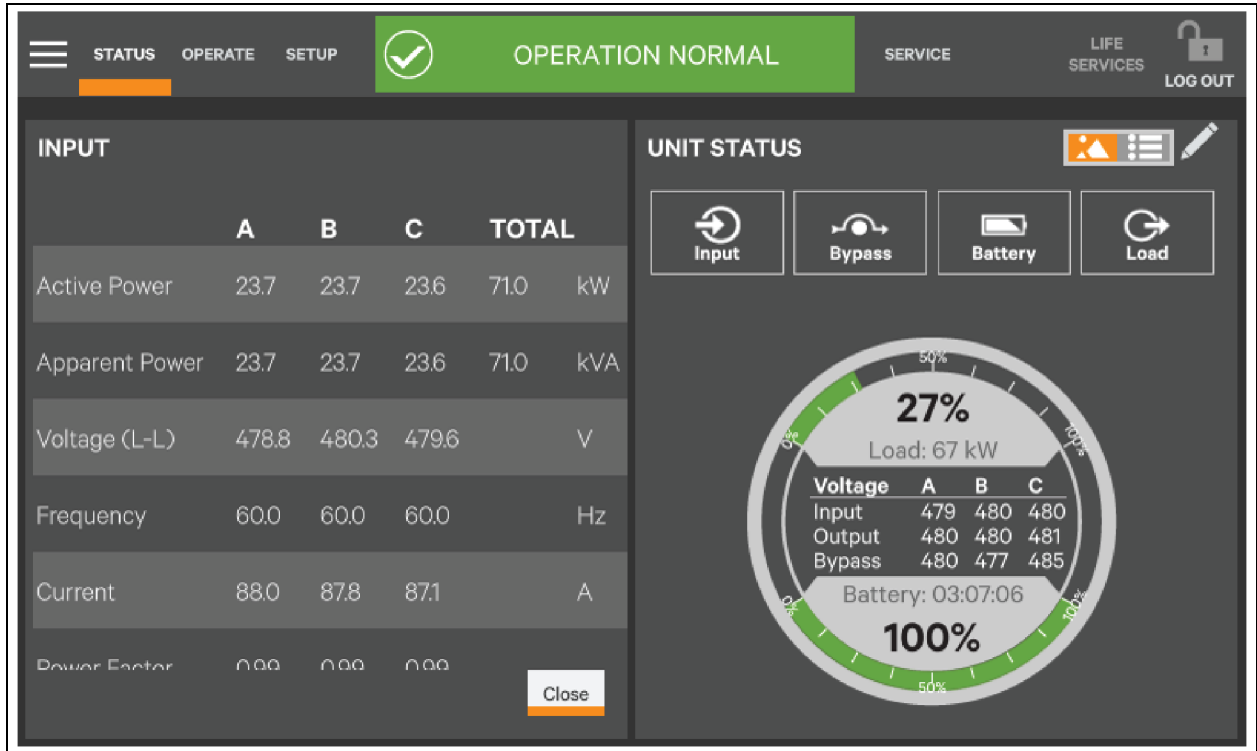

Figure 5.14 Unit Status — Bypass Details

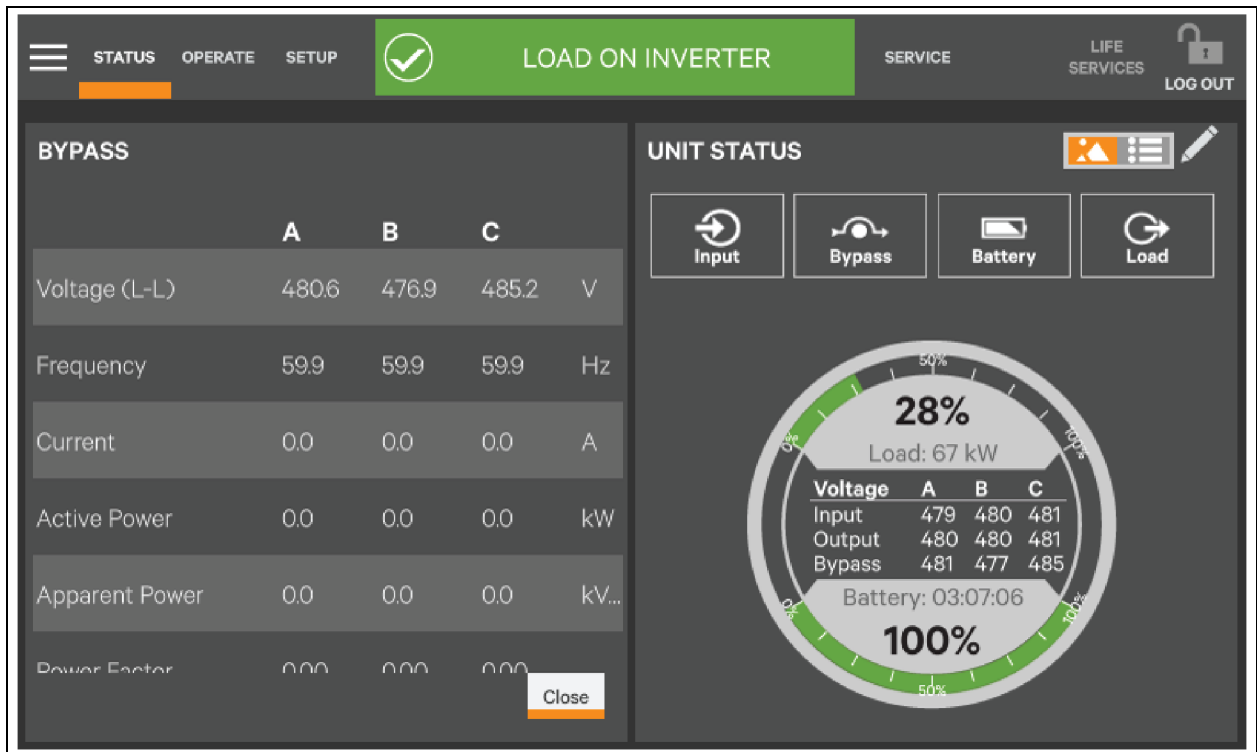

Figure 5.15 Bypass Details — Battery Details

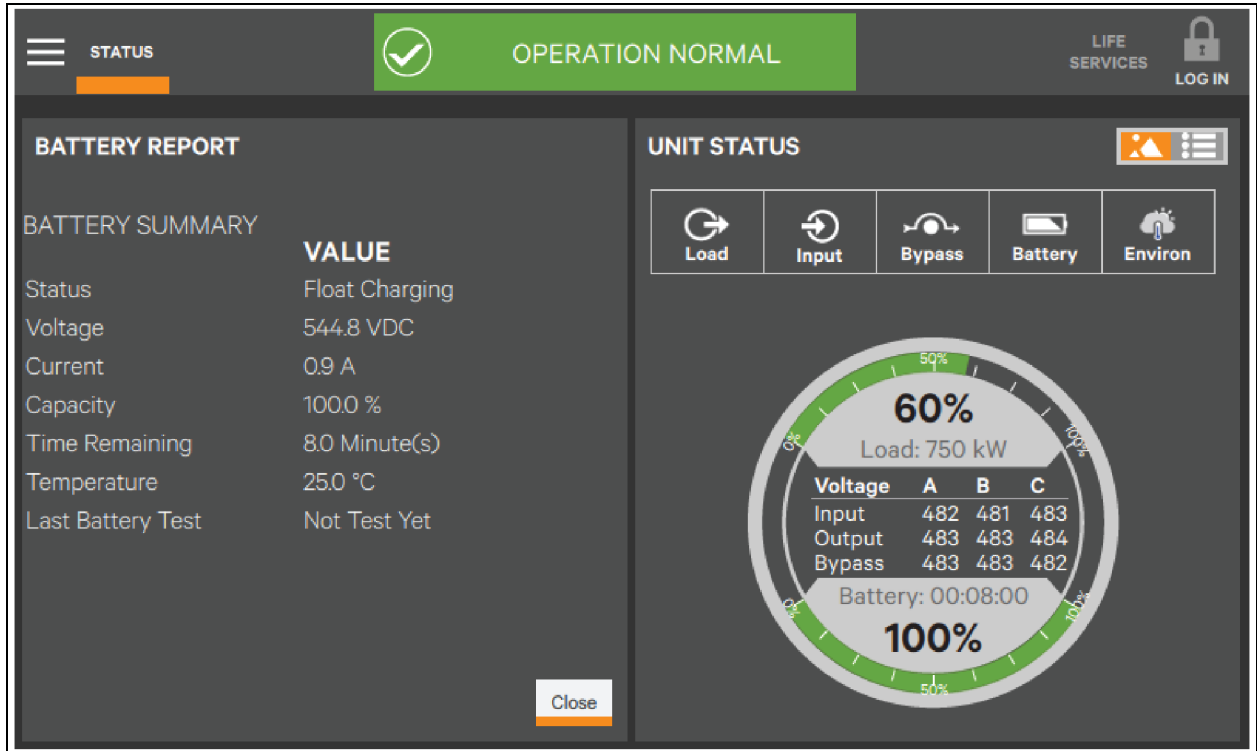
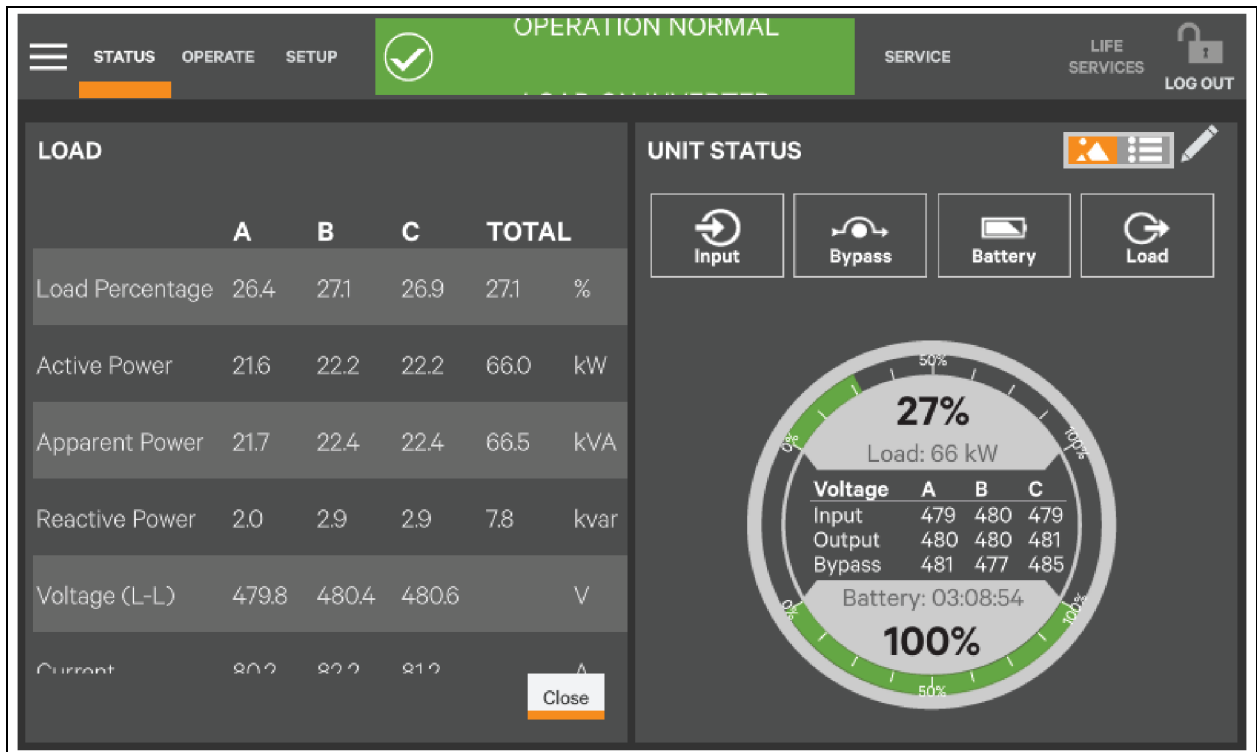

Figure 5.16 Bypass Details — Load Details



5.4.4 Logs Alarms and Events

The Context Menu, when opened from the Status pane, permits viewing logs of alarms, and events that have occurred on the UPS. Both logs include the date and time of occurrence, type, an ID, component affected and a description of the alarm or event. The information is available to all users, including observers, those without a log-in passcode.

To view the alarms or events:

1. Navigate to the Status pane, if required.
2. Touch the Context Menu icon.
3. Touch the log to view, alarms or events. See **Figure 5.17** below.

Touch the logs to see the UPS event log screen.

Touch Alarms to open a list of alarms.

Figure 5.17 View Alarms or Events

Date/Time	Type	ID	Com.	Description	Wave
23/2/2 PM2:56	✓	39F1	BYP	Module Comms. Normal	
23/2/2 PM2:57	⚠	3081	HMI	Load on Bypass	
23/2/2 PM2:56	✓	3011	HMI	Silence Active	
23/2/2 PM2:56	✓	39F1	MCM	Module Comms. Normal	
23/2/2 PM2:56	⚠	2021	PM1	No Battery	
23/2/2 PM2:56	✓	39F1	PM1	Module Comms. Normal	
23/2/2 PM2:56	⚠	2021	PM2	No Battery	
23/2/2 PM2:56	✓	39F1	PM2	Module Comms. Normal	

☰
STATUS
OPERATE
SETUP

VIEW EVENT LOG FOR DETAILS

LIFE SERVICES
LOG OUT

Export
Filter

Date/Time	Type	ID	Status	Com.	Description	Wave
23/2/2 PM2:57	Warning	3081	Set	HMI	Load on Bypass	
23/2/2 PM2:57	Critical	30B1	Clr	HMI	Load Off	
23/2/2 PM2:57	Critical	30B1	Set	HMI	Load Off	
23/2/2 PM2:57	Critical	39A1	Clr	HMI	Power Hardware Mismatch	
23/2/2 PM2:57	Info	10B1	Clr	PM2	Inverter in Setting	
23/2/2 PM2:57	Info	10B1	Clr	PM1	Inverter in Setting	
23/2/2 PM2:57	Info	1881	Clr	BYP	Bypass in Setting	

6 Single UPS Operation

This chapter briefly describes the operating precautions and routine operations for the Vertiv™ PowerUPS 9000 1250 kVA Modular UPS single module. For the operating precautions and routine operating methods of UPS parallel system, refer to [Parallel System and Load Bus Synchronization System](#) on page 93.

6.1 Introduction

NOTE: The user can perform the next operation only after the authorized engineer completes the first power ON and test of the UPS.



WARNING! Risk of electric shock and hazardous voltage of mains system and battery. The improper operation can cause equipment damage, personnel injury or death. The AC input and output terminals of the UPS have dangerous voltage. If the cabinet is equipped with an EMC filter, the filter may have dangerous voltage.

There are no operator serviceable parts located behind the covers that require a specific tool for removal. Only a qualified service engineer can remove the covers.

1. For the detail operation procedure of the control keys and touchscreen, see [Operator Control and Display Panel](#) on page 57.
2. The audible alarm sounds at various points during operation procedures. The alarm canceled at any time by pressing the Silence On/Off key.
3. When UPS uses traditional lead acid battery, the system provides boost charge optional function. If the lead acid battery is used, when the mains return after an extended mains failure, the charging voltage of the battery will be higher than the normal charging voltage. This is normal, and the charging voltage of the battery will return to normal value after a few hours charging.

6.2 UPS Start-up Procedures

The PowerUPS 9000 1250 kVA Modular UPS must be completely installed and commissioned before start-up by an authorized engineer. The external power supply switch must be closed. After these conditions are met, the UPS can be started.

6.2.1 Start-up Procedures in Normal Mode



WARNING! These procedures result in mains voltage being applied to the UPS output terminals. If any load equipment is connected to the UPS output terminals, check with the user that it is safe to apply power. If the load is not ready to receive power, disconnect the downstream load switch and place a warning label on the connection point of the load.

To start the UPS from a fully powered down condition, follow the below procedure:

1. Close the external input switch, ensure that the UPS input voltage, frequency, and phase are normal.
2. Close the output switch MIB, BIB, RIB, and all external output isolating switches (if any) of the UPS in turn.

After the HMI is fully started, touch the Log In icon to enter the system by typing correct password.

Figure 6.1 Inputting Password

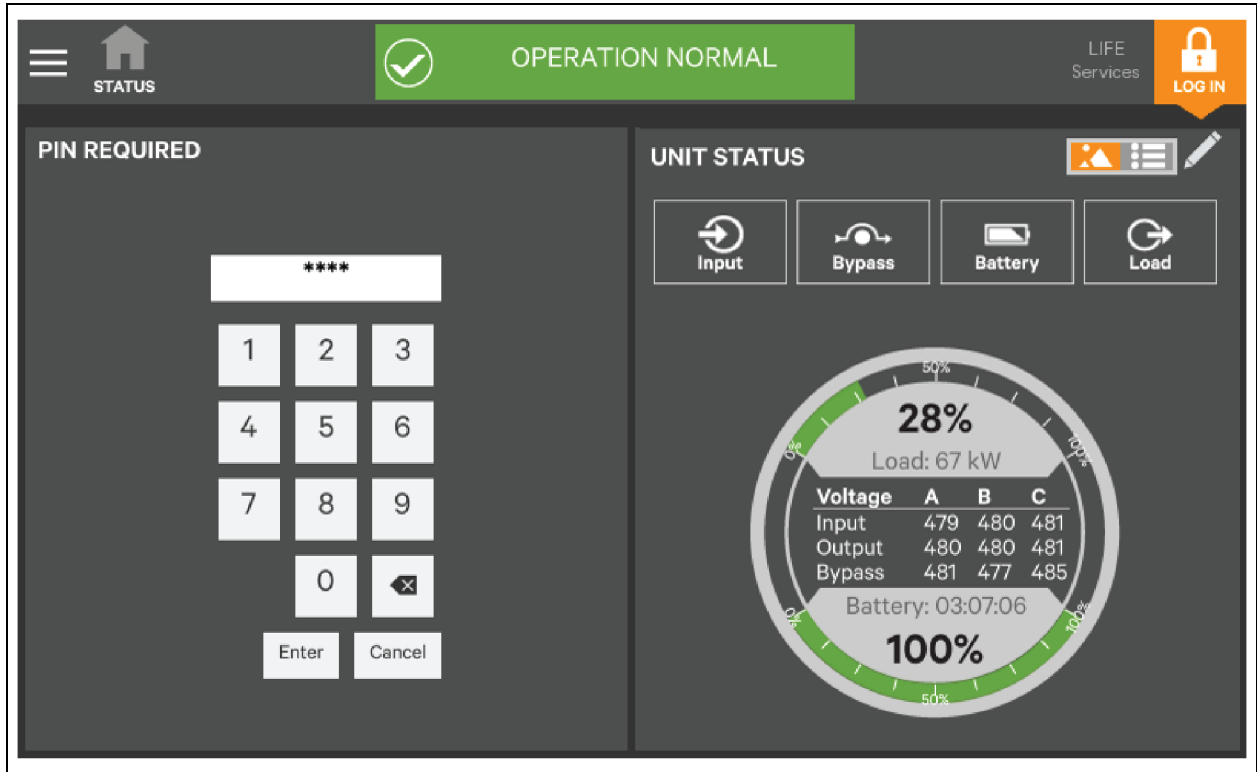

3. When the rectifier start process is finished, close the BCB and the system runs in bypass mode. See Power flow shown in **Figure 6.2** on the facing page. Touch the On. See [Operator Controls](#) on page 61 for more information.

Figure 6.2 Selecting Inverter On Key

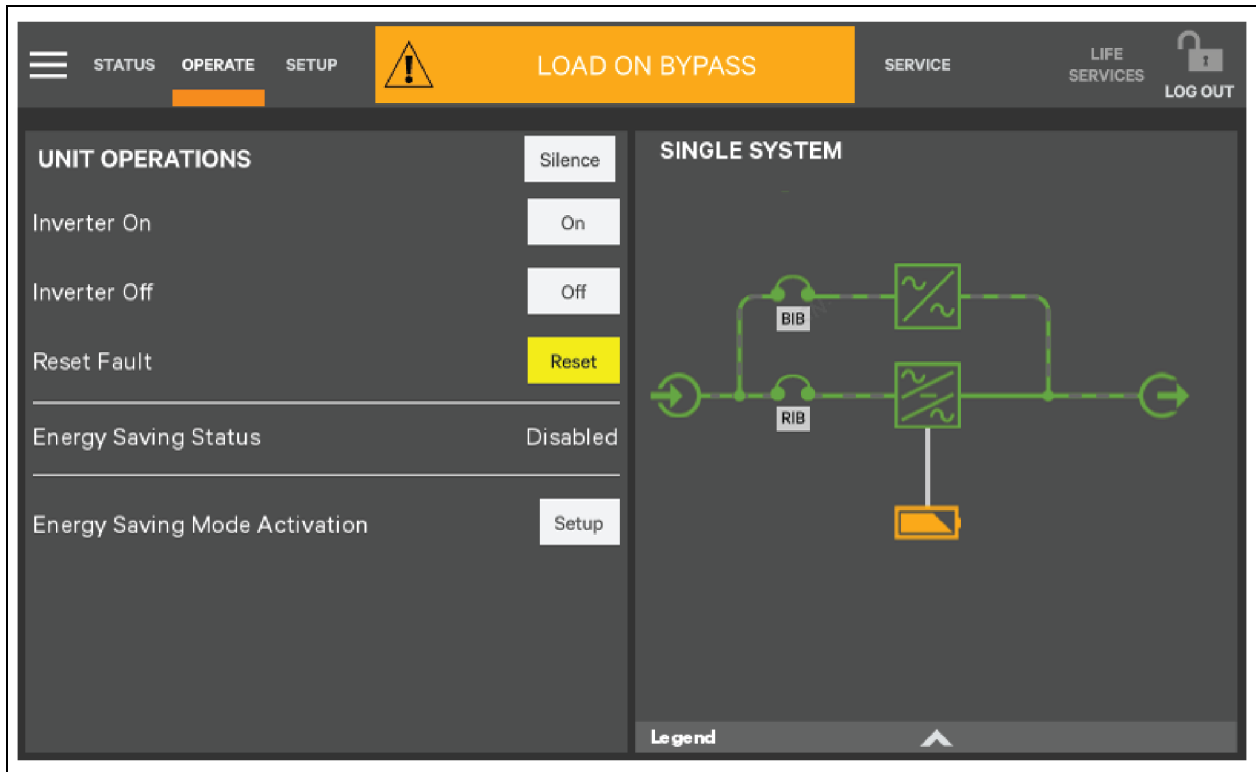

4. The inverter starts a self-test and synchronize.

Figure 6.3 Inverter Self-Test and synchronizes

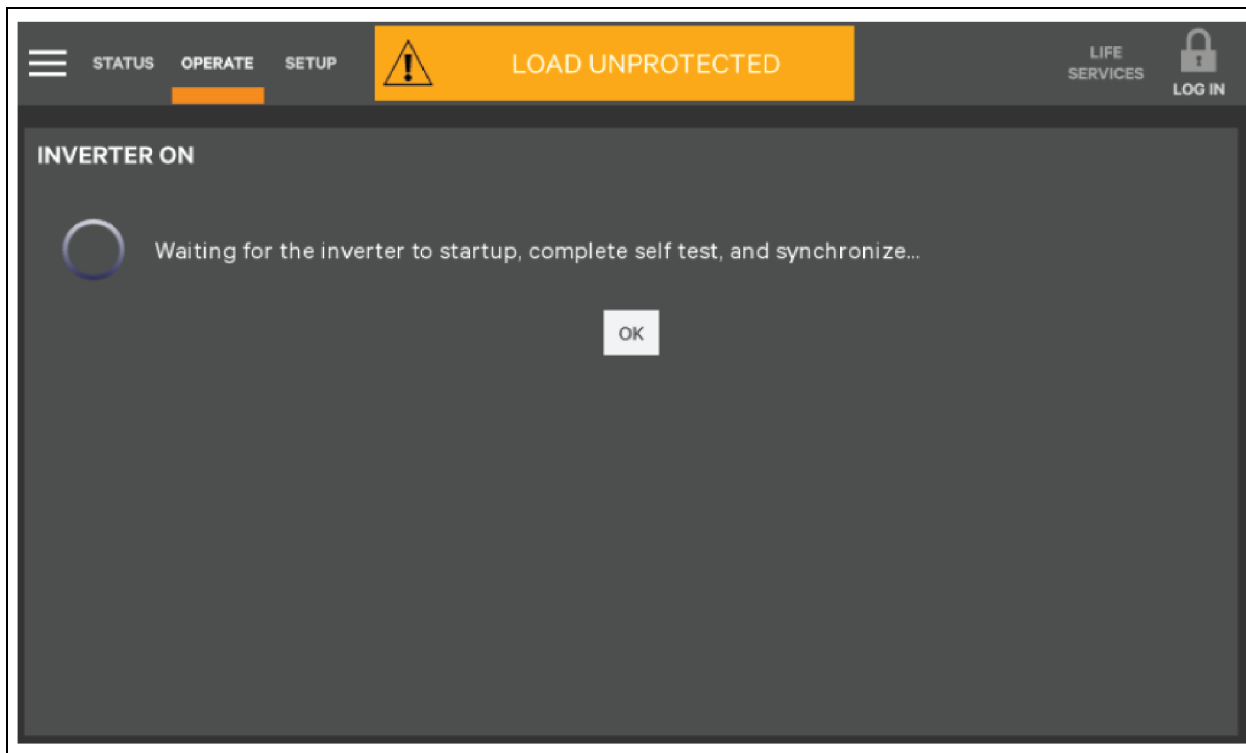

5. Start-up is finished.

Figure 6.4 Start Up Finished

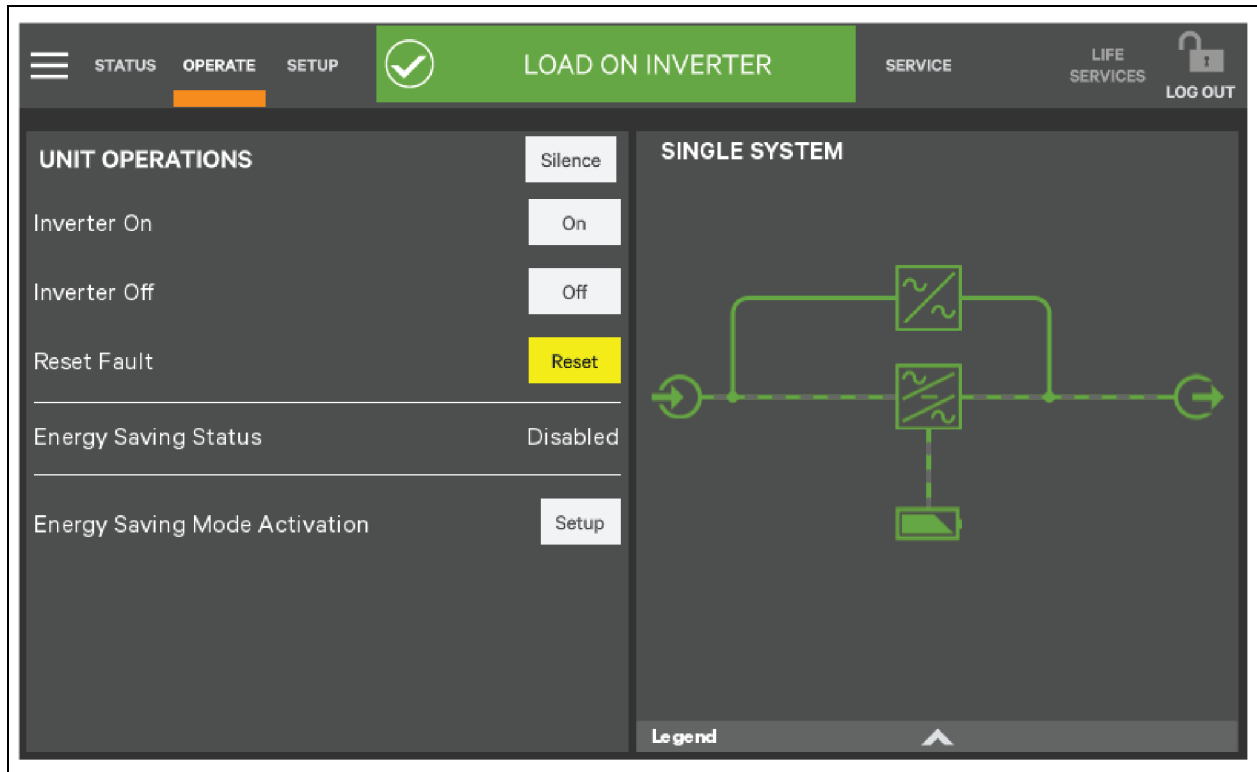

6.2.2 Start-up Procedures in Economic Mode

NOTE: In parallel UPS configuration, all operations related to disconnection or connection of the maintenance bypass switch shall be executed within 3 seconds to avoid overload situations and damage to the maintenance bypass switch.

1. Close the output MIB, BIB, RIB, and all external output isolating breakers (if any) of the UPS in turn.

The system is powered on, and the start-up screen activates.

2. If Eco mode is necessary, contact a Vertiv personal to activate it through the software setting. If you wish to activate it by yourself, you can enable it through the Energy Saving Mode Activation on the touchscreen. For details, see the [Operator Controls](#) on page 61 for more details.
3. Touch Setup next to the Energy Saving Mode Activation.
4. Select Eco Mode from the drop-down.
5. Touch Save.

Figure 6.5 Setting Eco Mode

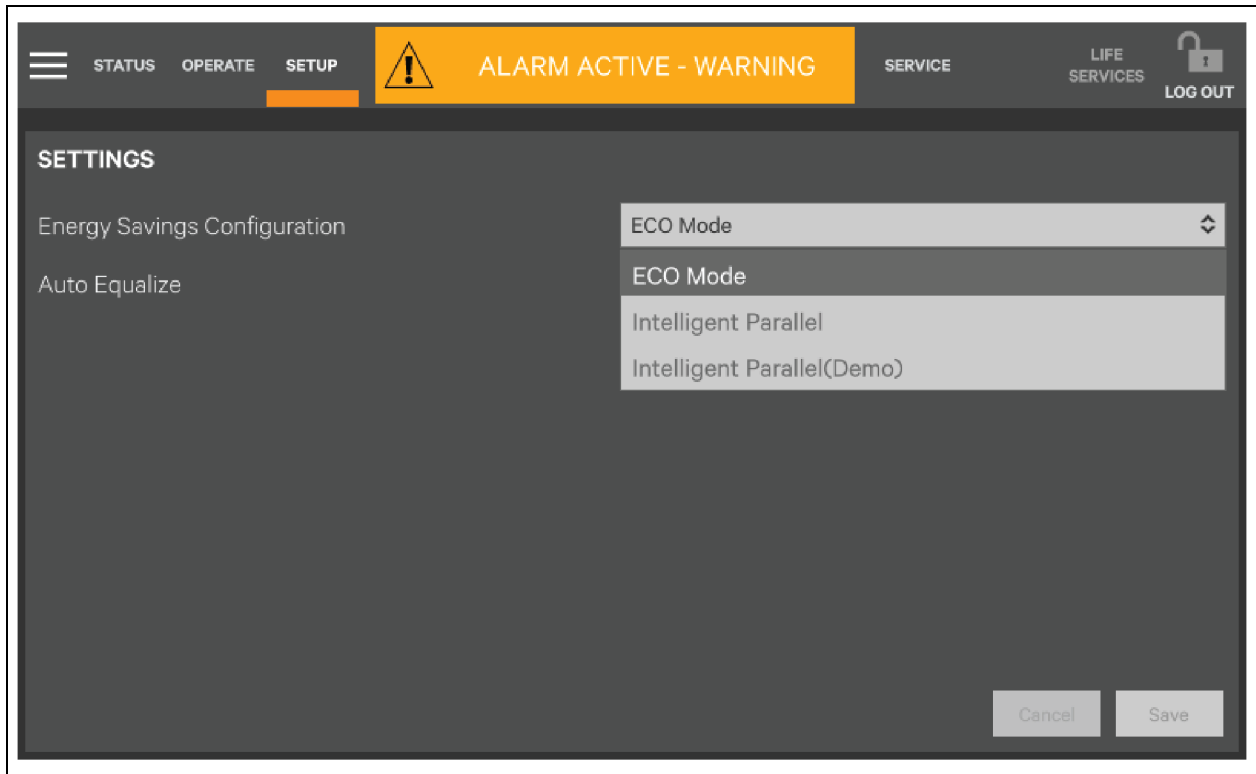

6. When the rectifier is started, start the system according to [Start-up Procedures in Normal Mode](#) on page 73.

After the inverter is running normally and if the bypass voltage is within the range of Eco power supply, then the system works in Eco mode, otherwise the system will transfer to inverter. The system will automatically work in Eco mode after the bypass voltage is within the range of Eco power supply for five minutes.

6.3 Procedures for Transfer Between Operation Modes

6.3.1 Transfer from Normal Mode to Battery Mode

Open the external power switch to isolate the mains power and initiate the UPS on battery mode. To transfer the UPS back to normal mode, close the external power switch to reconnect the mains power to the UPS. The rectifier restarts automatically in about 10 seconds and the UPS works in normal mode.

6.3.2 Transfer from Normal Mode to Bypass Mode

Procedure to transfer the load from the normal mode to the bypass mode.

1. Activate the system and log in to the system.
2. Touch the Operate tab.
3. Touch the Off button next to the Inverter Off. The UPS transfers to bypass mode. See [Figure 6.6](#) on the facing page.

Figure 6.6 Transfer UPS to Bypass Mode

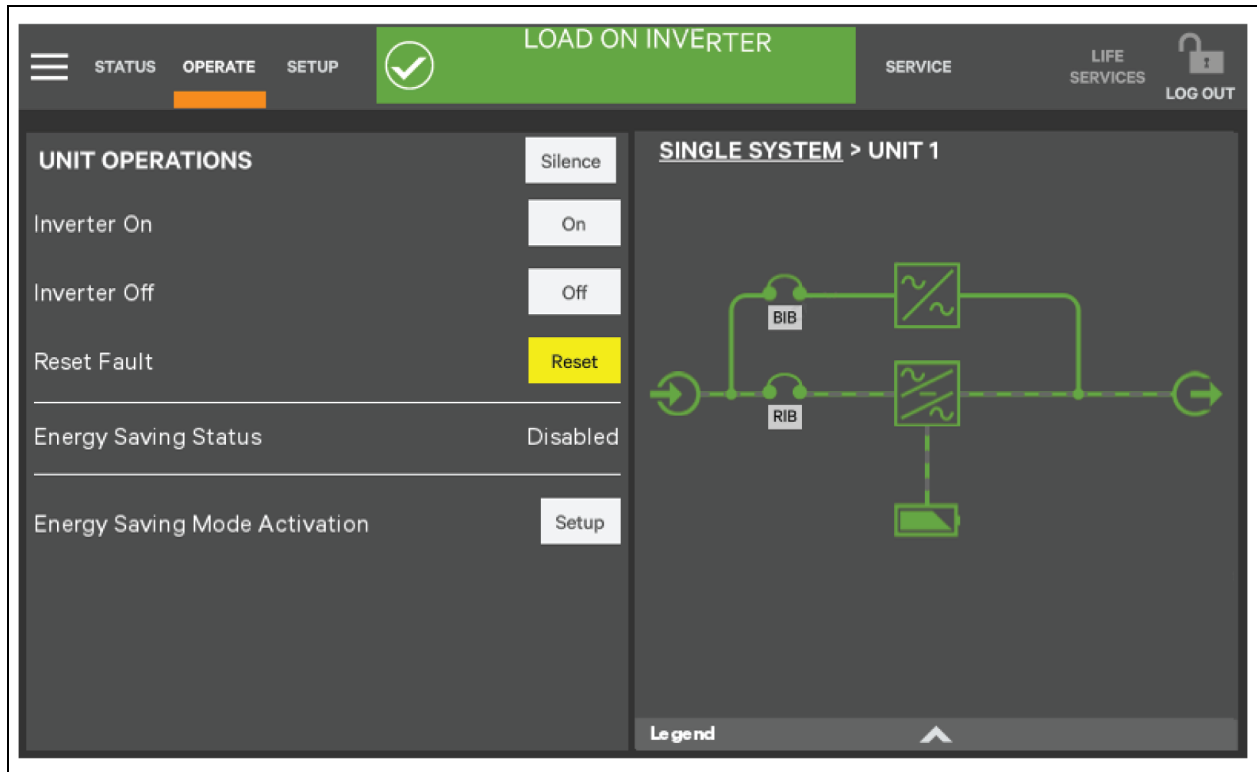

NOTE: In bypass mode, the load is directly supplied by the mains power instead of the pure AC power from the inverter.

6.3.3 Transfer from Bypass Mode to Normal Mode

Follow the procedure below to transfer the load from the bypass mode to the normal mode:

1. Activate the system and login to the system.
2. Verify that the Vertiv™ PowerUPS 9000 1250 kVA Modular UPS is in bypass mode.
3. Touch the Operate tab.
4. Touch the On button next to the Inverter On. The UPS transfers to normal mode from the bypass mode. See **Figure 6.7** on the next page.

Figure 6.7 Transfer UPS to Normal Mode

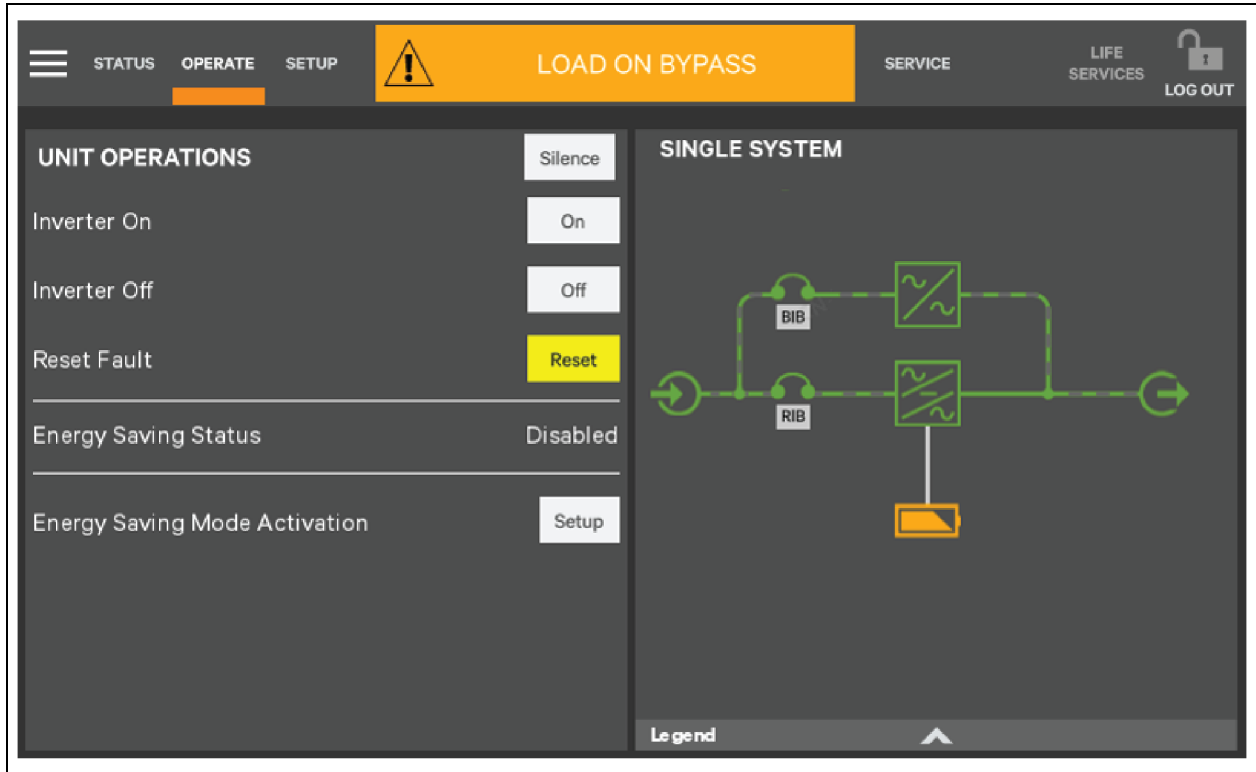

6.4 Battery Test Procedures

The battery test function is disabled by default. If you need this function, contact Vertiv's customer service.

The battery self-test includes periodical self-test and manual maintenance self-test.

- When the load factor is 0% to 20%, the system only supports manual maintenance self-test.
- When the load factor is 20% to 100%, the system supports periodical self-test and manual maintenance self-test.

The battery discharges 20% of total battery energy.

Periodical self-test is to test the battery activity. The periodical self-test is regular, and the self-test period can be configured via the Vertiv setting software. During the periodical self-test, if the battery maintenance requirement is met, the system generates audible/visual alarm and corresponding records. The periodical self-test does not update the battery curve table.

The mode of the manual maintenance self-test is like that of the periodical self-test, except for the maintenance self-test mode is started manually, and this operation is valid only one time, that is the system will not automatically start up the self-test once you exit. When the load factor is 20% to 100%, during the maintenance self-test, if the battery maintenance requirement is satisfied, the system will generate audible/visual alarm and corresponding records. The maintenance self-test does not update the battery curve table.

NOTE: The periodical self-test should satisfy the conditions of battery float charge at least 5 hours, and generator not connected, while the manual maintenance self-test just satisfies the conditions of battery fully charged.

How to do a test:

1. **Manual maintenance self-test:** through the Touchscreen.

2. **Periodical self-test:** A self-test period can be configured via the Vertiv setting software. The range of battery self-test period is 30 days to 360 days. The default is 60 days.

Self-test start-up conditions:

1. System load rate is within 0% to 100% (manual maintenance) or 20% to 100% (periodical self-test), stable output.
2. Battery in fully charged state, battery float charge at least 5 hours and generator not connected.
3. Current system is in float charge state.

Self-test exit conditions:

1. Confirm that the system is not in self-test state for at least 10 seconds and battery mode or rectifier is closed. The system shifts to battery supply state.
2. During the self-test, the system will shift to float charge state if the load fluctuation, UPS module overload or no battery occurs.
3. During the self-test, if the battery voltage is lower than the calculated pre-alarm voltage, or the battery discharge exceeds the protection time, then the system will shift to float charge state.
4. The user can manually stop the maintenance test via the touchscreen.
5. During the manual maintenance self-test, when the load rate ranges from 0% to 20%, the system will shift to float charge state after the battery discharge for 5 minutes.

NOTE: After the self-test is successful, the system will fully clear the self-test interval counter. If the self-test fails this time, then exits the system; when self-test conditions are satisfied again, enters self-test once more.

Procedures for battery self-test:

1. Enter the level of **Operate**.
2. Touch the Operate icon.
3. Touch the menu icon on the upper left corner.
4. Touch the Battery Operations to display the interface shown in **Figure 6.8** on the next page.

Figure 6.8 Battery Management Interface

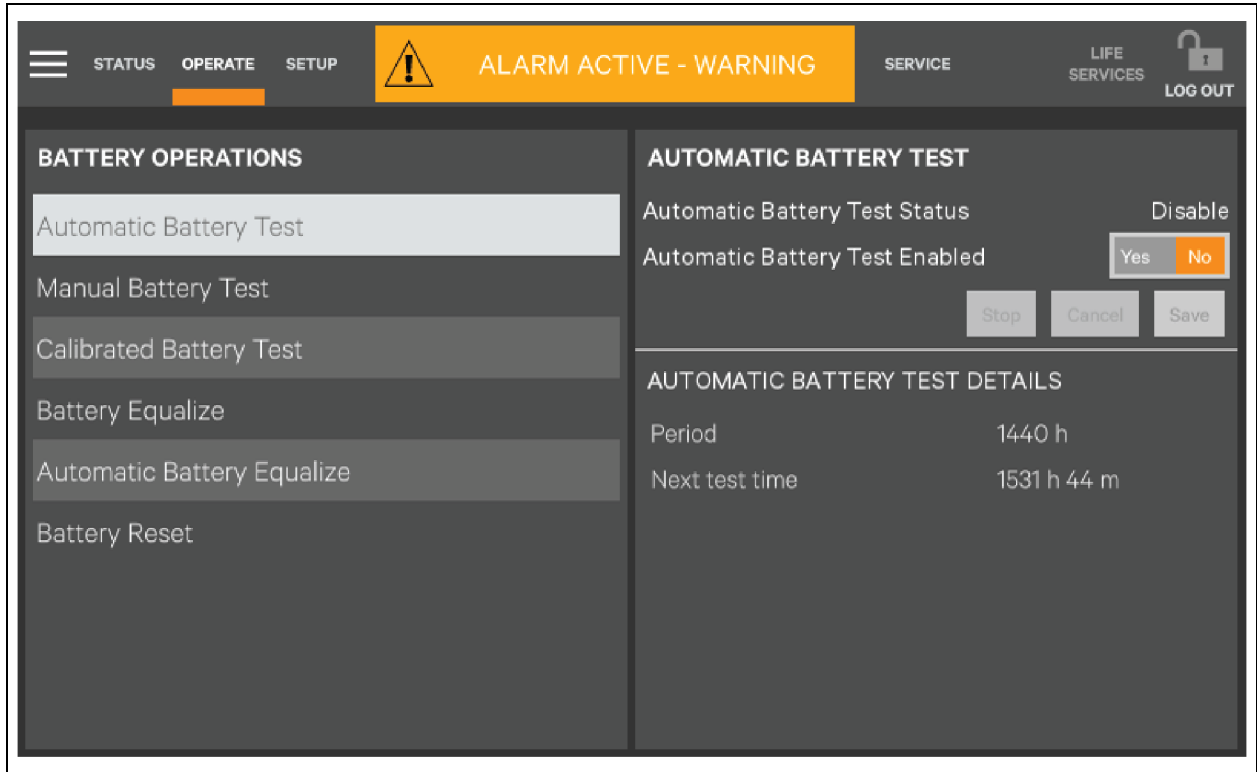

5. Respectively touch **Automatic Battery Test**, **Manual Battery Test**, **Calibrated Battery Test**, and **Battery Equalize**, then you can execute corresponding settings and operation.

6.5 UPS Shutdown Procedures

6.5.1 Procedures to Completely Power Down the UPS

Follow the below procedure to completely shutdown the UPS and load power off. All power switches, isolating switches, and breakers are disconnected, and then UPS no longer supplies power to load.

NOTE: The following procedures cut off the load power completely.

1. Touch the Inverter Off key to stop the operation of the inverter. See the [Operator Controls](#) on page 61. then disconnect the external switches to stop the operation of the rectifier, static switch, and battery.
2. Now, all the internal power supply is off, and the touchscreen does not display any more.



WARNING! Hazardous battery voltage. The battery terminals still have hazardous voltage after the UPS is completely shutdown.

NOTE: Wait 10 minutes for the internal DC bus capacitance to complete discharging. Then the UPS completely shuts down.

NOTE: Place a lockout tagout (LOTO) at the AC input distribution (generally far away from the UPS) to alert that the UPS maintenance is being operated.

6.6 Emergency Power Off Procedures

The EPO is designed to switch off the UPS in emergency conditions (such as fire or flood). To carry out EPO, press the EPO button, then the system turns off the rectifier and inverter. Power to the load is stopped immediately (including the inverter and bypass) and the battery stops charging or discharging.

After EPO, if the input mains is present, the UPS control circuit remains active; however, the output will be turned off. To remove all power from the UPS, first disconnect the external power switch of the UPS.

6.7 UPS Reset Procedures after Emergency Power Off

After shutting down the UPS through EPO or the UPS fault condition, clear the fault according to the alarm message appearing on the touchscreen.

After confirming the fault has been cleared and no remote EPO signal is received, follow these procedures:

1. Touch the Reset Fault button. See [Operator Controls](#) on page 61. The system will exit the EPO/abnormal OFF state and the alarm indicator flashes red.
2. After the rectifier start up is finished, normally start the UPS according to [Transfer from Bypass Mode to Normal Mode](#) on page 79.

NOTE: The rectifier starts automatically when the overtemperature fault disappears five minutes after the disappearance of the overtemperature signal.

3. After the EPO button is pressed, if the mains input is switched off, the UPS shuts down completely. When the mains input is restored, the UPS enables the bypass. Restore the power at the output terminal of the UPS.

6.8 Automatic Restart

The UPS uses the battery system to supply power to the load equipment in the event of mains failure until the batteries are discharged. When the UPS reaches its EOD threshold, it will shutdown.

The UPS will automatically restart and enable output power only when the following conditions are met:

1. If Auto Recovery after EOD Enabling is enabled.
2. After the Auto Recovery after EOD Delay Time expires (the default delay is 10 minutes), the UPS restarts bypass, then inverter.

NOTE: During the automatic restart process, manual start-up is disabled. Automatic restart must be set by Vertiv's authorized service engineer through Vertiv setting software.

This page intentionally left blank

7 Battery

This chapter provides information about the battery, the battery types, charging/discharging, battery cold start, safety, installation and maintenance information, battery protection function, and the connection of BCB cabinet (option), battery temperature sensor (option), and battery ground fault detector.

7.1 Introduction

The UPS battery string consist of several batteries in series connection and provides rated DC input voltage for the UPS inverter. The required battery backup time (that is the time for battery to supply load upon mains failure) is subject to the ampere hour value of the battery. Sometimes, it is necessary to connect several battery strings in parallel.

To facilitate the UPS installation, the battery is generally installed on a specially designed battery rack or in the battery room.

During the maintenance or repair, the battery must be disconnected from the UPS. This operation is carried out with the BCB of proper capacity. This circuit breaker must be located as close as possible to the battery connecting terminal. The wiring distance of the power and signal cables connected to the UPS must be minimized.

When several strings of battery are connected in parallel to increase the battery backup time, disconnecting device shall be equipped so that the maintenance operation on a certain battery string will not affect the normal operation of other battery strings.

7.2 Safety

If you have any questions, contact Vertiv.



WARNING! Work carefully with the batteries connected to the UPS when all the blocks are connected, the battery string voltage can be up to 540 VDC. This is potentially dangerous. Follow the precautions for high voltage operation. Only qualified personnel can install and maintain the battery.

To ensure safety, the external batteries are to be installed inside a lockable cabinet or in a dedicated battery room only accessible to qualified service personnel.

Make sure that the battery switch has been disconnected before battery maintenance.

7.2.1 Safety Precautions

Observe the following safety precautions when working on the batteries:

1. The battery must be firmly and reliably connected. After the connection is completed, the screw connections between all the terminals and the batteries shall be torqued. The requirements on torque specified in the specifications or user manual provided by the battery manufacturer shall be satisfied. The connections between all the wiring terminals and the batteries shall be inspected and tightened at least once a year. Otherwise it may cause fire.
2. The battery appearance must be inspected before accepting and using the battery. Replace the battery with a new one if the package is damage, the battery terminals are dirty, corroded, or rusted, or the shell is cracked, deformed, or leaked. Battery capacity reduction, electric leakage, or fire may occur if the damaged battery is not replaced.

3. The battery is very heavy. Use a proper method to move and lift the battery, so as to prevent injury or any damage to the battery terminal. Severe damage to the battery may cause fire.
4. The battery connecting terminal must not be subject to any force, such as the pulling force or twisting force of the cable, to avoid damage to the internal connection of the battery. Severe damage to the battery may cause fire.
5. The battery must be installed and stored in a clean, cool, and dry environment. Do not install the battery in a sealed battery chamber or a sealed room. The battery room ventilation must meet the requirement of EN50272-2001. Otherwise, battery bulging, fire, or human injury may occur.
6. The battery shall be installed far away from the heating products (such as the transformer), used or stored far away from any fire source, shall not be burnt or put into fire for heating. Otherwise, battery leakage, bulging, fire or explosion may be caused.
7. Do not directly connect any conductor between the positive and negative terminals of the battery. Remove the finger rings, watch, necklace, bracelet and other metal items before operating the battery and ensure that tools (such as wrench) are covered with insulating material. Otherwise, battery burning, human death/injury or explosion may be caused.
8. Do not disassemble, modify or demolish the battery. Otherwise, battery can short circuit, liquid leakage, or human injury may occur.
9. Clean the battery enclosure with a wringed wet cloth. To avoid static or arcing, do not use a dry cloth or duster to clean the battery. Do not use the organic solvent (such as thinner, gasoline, or volatile oil) to clean the battery. Otherwise, the battery enclosure may be cracked. In worst case, fire may be caused.
10. The battery has diluted sulfuric acid. In normal use, the diluted sulfuric acid will be absorbed by the baffle and polar plate of the battery. However, if the battery is damaged, the acid may leak from the battery. Personal protective equipment (such as protective glasses, rubber gloves, and apron) must be used when operating the battery. If diluted sulfuric acid comes in contact with the eyes, blindness may result. If it comes in contact with the skin, burns may result.
11. The battery may have short circuit, electrolyte dry-up, or positive pole erosion failure at the end of its life. If it is still used under this state, the battery may have thermal runaway, bulging or liquid leakage. Replace the battery before it reaches this state.
12. Before connecting or disconnecting the battery connection cables, isolate the charging power.
13. Check if the battery has been unexpectedly earthed. If this is the case, remove the earth connection. Contact with any part of the earthed battery may result in an electric shock.

7.3 UPS Battery

The UPS generally adopts valve regulated battery. Valve regulated means the sealed type or maintenance free.

The valve regulated battery is not completely sealed, when it is over charged, there is gas escape. The volume of the gas escape is less than with a water injection battery. However, during the installation design of the battery, temperature rise should be considered, and enough room must be reserved to ensure good ventilation.

The valve regulated battery is not maintenance free. The valve regulated battery must be kept clean, and inspected regularly to check for corrosion and that the connection is reliable.

It is recommended to connect no more than 4 strings of batteries in parallel. Batteries of different types, names or newness must not be used together. Otherwise, the battery inconsistency will cause frequent over discharge or under charge of certain battery. The battery will have premature failure and the entire string of battery will have insufficient backup time.

Batteries must be stored in a fully charged state. Batteries will lose some capacity because of self-discharge during transportation or storage. Charge the battery before use. During the storage, ensure that the ambient temperature does not exceed the range of 5 °F to 113 °F (-15 °C to +45 °C). Optimal temperature is 68 °F to 77 °F (20 °C to 25 °C). To compensate for the self-discharge of the battery during the storage, the battery must be charged every 3 months during storage. The specific time may differ for different batteries. For details, refer to the requirements of the battery manufacturer.

Fully charge the battery that will be used to test the battery backup. The test may take several days. Conduct this test after battery is float charged for at least 1 week uninterrupted.

Battery performance increases after running for several weeks or has been subject to 2 or 3 charge/discharge cycles.

To avoid the battery over charge or under charge, set the battery management parameters according to the equalizing/float charge voltage and temperature compensation factor specified in the manuals provided by the battery manufacturer. Charge the battery immediately after discharge.

7.4 Precautions for Installation Design

NOTE: Use and maintenance of the battery are described in the relevant battery manual provided by the battery manufacturer. The safety precautions described in this section include the important precautions that must be considered during the installation design. The design results may be changed according to the local situations.

7.5 Battery Installation Environment and Number of Batteries

7.5.1 Installation Environment

Fresh air volume (EN50272-2001)

The operating environment of the battery must be ventilated. During the operation of the battery, the requirement for the fresh air ventilation is:

$$Q=0.05 \times n \times I_{gas} \times C_{rt} \times 10^{-3} \text{ [m}^3\text{/h]}$$

Where:

Q - The fresh air ventilation volume per hour, the unit is m³/h

n - Number of cells

I_{gas} - The gas evolving current density under battery float charging or boost charge conditions, the unit is mA/Ah

I_{gas}=1, under the float charging condition of 2.27 V/cell

I_{gas}=8, under the boost charge condition of 2.35 V/cell

C_{rt} - 20 hours battery rated capacity

Temperature

Table 7.1 Ambient Temperature Range

Type	Temperature Value	Remark
Recommended optimal temperature	68 °F to 77 °F (20 °C to 25 °C)	The ambient temperature for the battery operation must not be too high or too low. If the average operating temperature of the battery rises from 77 °F to 95 °F (25 °C to 35 °C), the service life of the battery will be reduced by 50%. If the operating temperature of the battery is over 104 °F (40 °C), the service life of the battery will be reduced exponentially each day.
Short time allowable temperature	5 °F to 113 °F (-15 °C to 45 °C)	

Battery life is shortened with higher temperatures. Charge/discharge performance is reduced at low temperatures

The battery must be installed in cool and dry environment with the humidity less than 90% and be protected from the heat source and direct sun rays.

The ambient temperature, ventilation, space, float/boost charge voltage, and ripple current affect the battery temperature. Uneven temperature among the battery strings causes uneven voltage distribution and thus result in problem. It is important to maintain balanced temperature in the battery string. The temperature difference between batteries of different layers should be kept within 37.4 °F (3 °C). A valve regulated battery is very sensitive to temperature, should be used in 59 °F to 77 °F (15 °C to 25 °C). If the battery cabinet is installed near the UPS, the maximum design ambient temperature should be determined according to the battery rather than the UPS. That is, if a valve regulated battery is used, the indoor ambient temperature range should be 59 °F to 77 °F (15 °C to 25 °C) rather than the operating temperature range of the main equipment. A short time temperature deviation is allowable if the average temperature does not exceed 77 °F (25 °C).

7.6 Battery Protection

IMPORTANT! Appropriate switching devices to protect the battery from short circuit and overload must be selected. It is recommended to use the Vertiv BCB to provide better battery protection.

The battery is connected to the UPS through the BCB. The BCB is manually closed and has an electronic tripping device controlled by the UPS control circuit. If the battery is rack mounted (or is far away from the UPS cabinet), the BCB must be installed as close to the battery as possible, and the wiring distance of the power and signal cables connected to the UPS must be minimized.

The BCB has the following features:

- Isolation
- Short circuit protection
- In case the inverter is locked by a battery that is under voltage, the switch automatically disconnects in order to avoid damage due to a battery over discharge.
- If equipped with a remote EPO button, an EPO button can be used to remotely disconnect the BCB.

To obtain the required backup time, the batteries may be connected in parallel. In this case, each battery string must be connected to a separate BCB.

NOTE: Only trained personnel must operate and maintain the battery circuit breaker. While some battery manufacturers may not mandate the use of a battery breaker, they typically provide an alternative method for disconnecting power flow, such as a switch or contactor. This disconnect mechanism is used alongside DC-rated fuses to protect against overcurrent and short circuits.

7.7 Battery Installation and Connection



WARNING! Only a qualified engineer should install and connect the batteries. The battery has hazardous high voltage, and requires insulated tools for safety protection.

1. Before installation, check the battery appearance to ensure that there is no damage, inspect and count the accessories, and carefully read this manual and documentation provided by the battery manufacturer.
2. Make sure that there is at least 0.4 in. (10 mm) gap between the batteries vertically to permit circulation.
3. Clearance should be maintained between the battery top and the upper row to facilitate monitoring and maintenance of the battery.
4. The batteries should be installed from the bottom to top to avoid a too high gravity center. The batteries should be installed to protect from vibration and shock.

7.8 Other External Battery

7.8.1 VRLA Battery Cabinet

The Vertiv™ PowerUPS 9000 1250 kVA Modular UPS supports external VRLA battery cabinet. The number of batteries, EOD voltage, and float charging voltage as shown in **Table 7.2** below.

Table 7.2 Number of Batteries

Parameter	1250 kVA 480 V
Number of cells (standard)	180 to 300, even numbers can be set consecutively; 240 to 300, UPS output power no derating, 180 to 240
EOD voltage	1.60 VDC/Cell to 1.85 VDC/Cell, 1.67 V/cell recommended
Float charging voltage	2.2 VDC/Cell to 2.3 VDC/Cell, 2.27 V/cell recommended

7.8.2 Ni-Cd battery cabinet

The UPS supports external Ni-Cd battery cabinet. The number of batteries, EOD voltage, and float charging voltage as shown in **Table 7.3** below.

Table 7.3 Number of Batteries

Parameter	1250 kVA 480 V
Number of cells (standard)	320 to 480, even numbers can be set consecutively; 428 to 480, UPS output power no derating
EOD voltage	0.9 VDC/Cell to 1.1 VDC/Cell, 1.0 V/cell recommended
Float charging voltage	1.35 VDC/Cell to 1.45 VDC/Cell, 1.45 V/cell recommended

7.8.3 Lithium Ion Battery Cabinet

The PowerUPS 9000 1250 kVA Modular UPS series supports EnergyCore Lithium battery, the Vertiv™ EnergyCore Lithium 5 is a high power standby battery cabinet designed for use with uninterruptible power supply (UPS). EnergyCore Lithium can be defined by the requirement. Various battery modules are available in different series configurations, with increased number of battery modules allows for higher voltage and additional energy storage. Refer **EnergyCore Lithium 5 service manual SL-71289** for detail information.

7.9 Battery Ground Fault Detector

Vertiv provides a battery ground fault detector. It includes a mutual inductor and PCB.

NOTE: If a battery ground fault detector is installed, the positive, negative and neutral battery cables from the battery into the BCB cabinet must be routed through the hole of the mutual inductor of the battery ground fault detector, while other cables must bypass the mutual inductor for connection.

Figure 7.1 Battery Ground Fault Detector for 1250 kVA 480 V

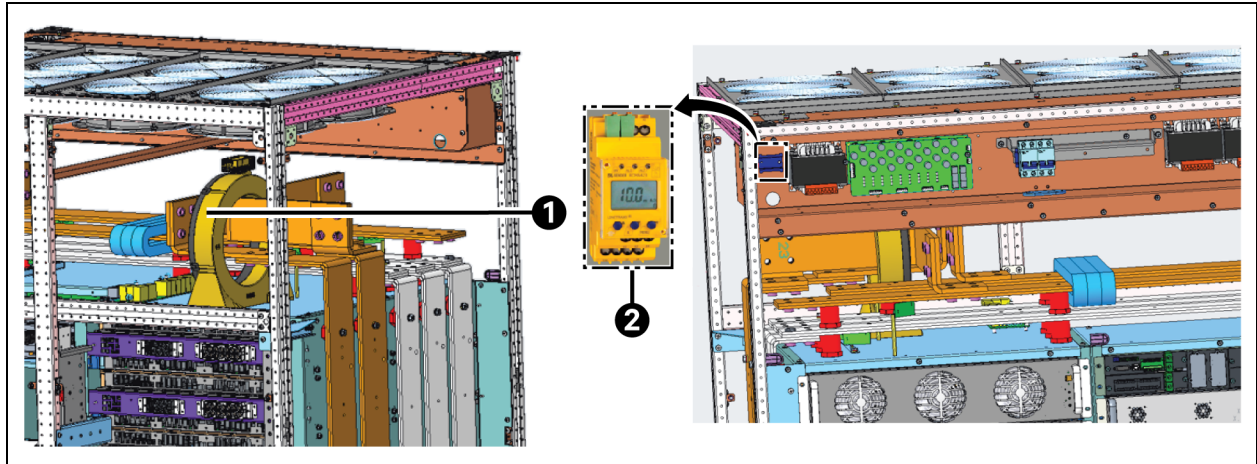

Item	Description
1	Current transformer (CT)
2	Bender controller/relay

7.10 Power Supply Units for Battery Interface Board

Vertiv™ PowerUPS 9000 1250 kVA Modular UPS provides power supply units (PSU) for BIBs in the battery cabinets. The following equipment shown in **Table 7.4** below needs to be ordered depending on the battery type and battery configuration chosen.

Table 7.4 BIB Equipment

Item	Content	Quantity
For each UPS	PSU kit (safety block, 2 power supply units, the diodes, 24 VDC 5 Amps terminals)	1
For each battery cabinet	UPS BIBX	1
	Battery temperature sensor	2

The PSU kit is installed under the top panel of UPS. The Panel on top can cover all the kit. This component is factory-installed. See **Figure 7.2** on the facing page and **Figure 7.3** on page 92 for the PSU kit structure and wiring diagram. For BIB dry contact configuration, see [Wiring of Signal Cable](#) on page 45.

Figure 7.2 PSU Kit for 1250 kVA 480 V

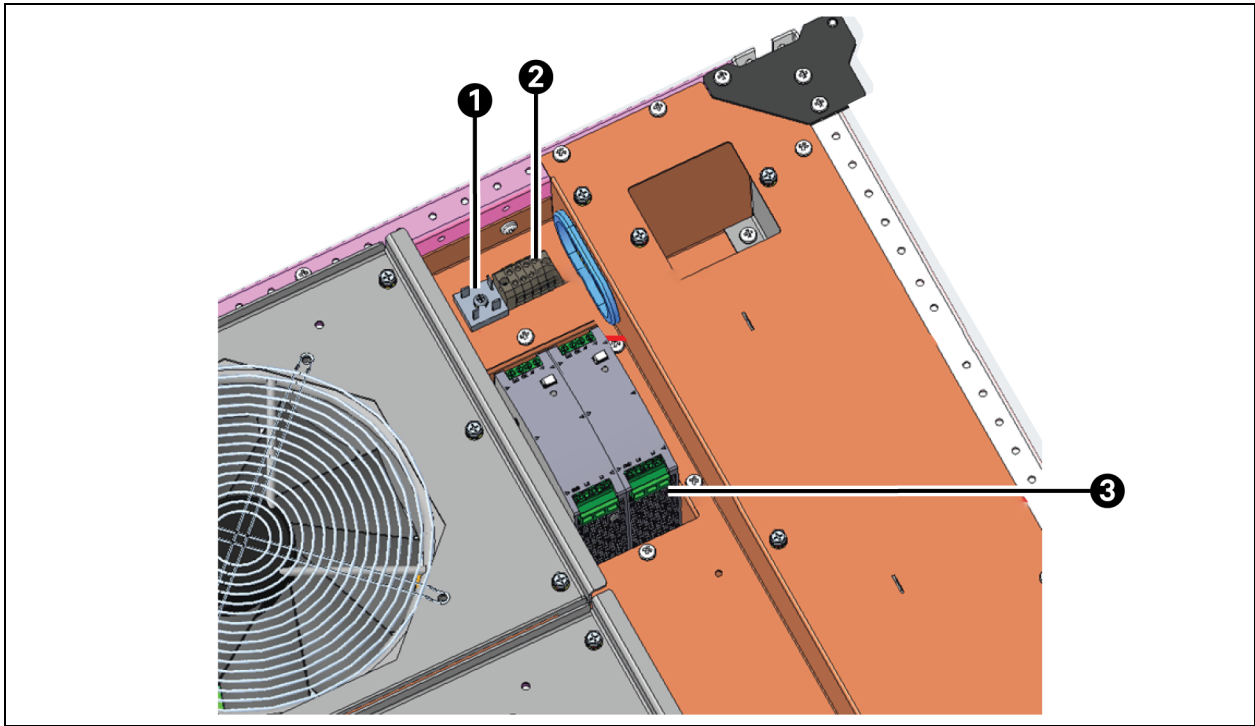

Item	Description
1	Diodes
2	24 V terminals
3	Power supply units

Figure 7.3 PSU Kit Wiring Diagram

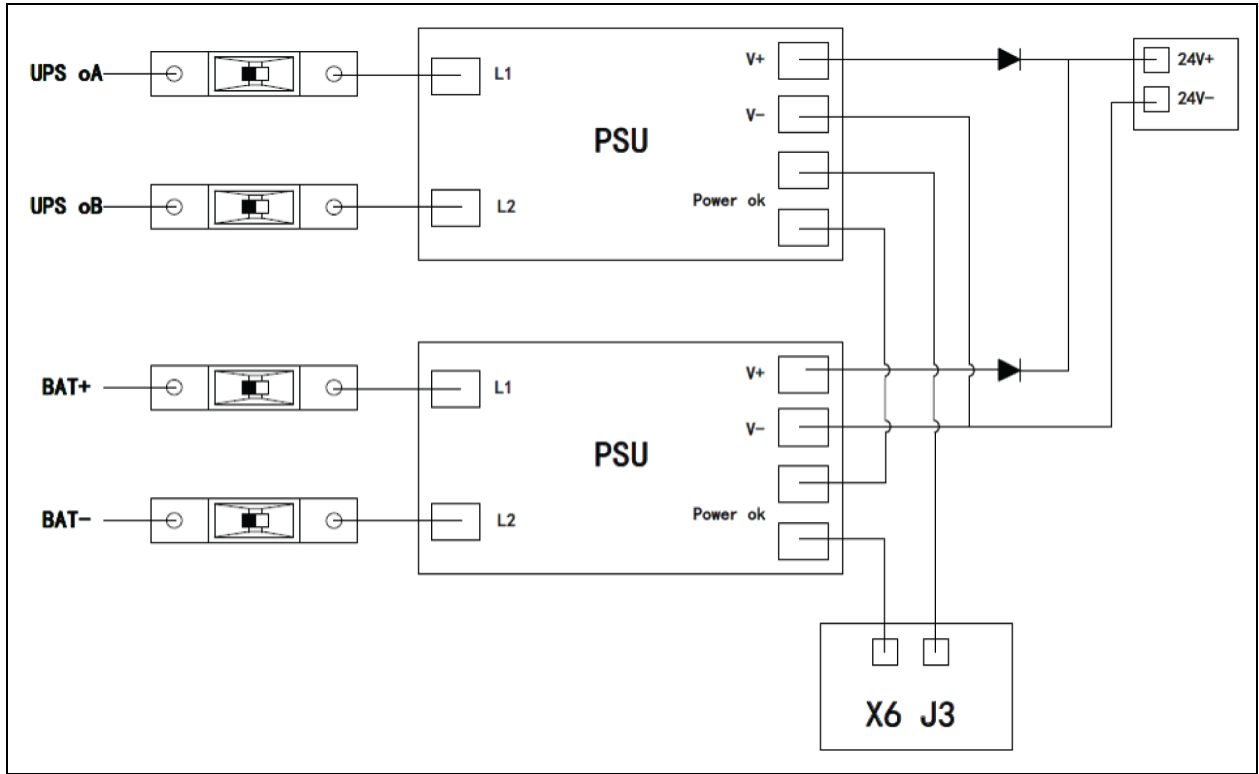

8 Parallel System and Load Bus Synchronization System

This chapter gives details on the installation of the parallel system and load bus synchronization (LBS) system.

8.1 General

The parallel system is comprised of up to four UPS modules of the same power rating and connected in parallel without the need for a centralized mains static bypass. Instead the bypass static switches of each UPS share the load when the system transfers to the mains bypass supply.

In a parallel system, each module is internally identical to the single module configuration. A parallel system requires inter-module control signals to manage the load sharing, synchronizing and bypass switching. The control signals are connected through parallel cables that are multicore ribbon cables connected between the units of the system to form a closed loop.

8.2 System Installation Procedures

The basic installation procedure of a parallel system is the same as that of a single module system. The installation of a parallel UPS should follow the installation procedure for a single UPS module with the additional requirements detailed in this section.

8.2.1 Preliminary Checks

Ensure that the selections of the parallel cables are correct, and that the modules are of the same rating, model, and with the same software and hardware release.

IMPORTANT! Vertiv service personnel must configure each module separately using Vertiv setting software to achieve coordinated operation of the modules in the parallel system.

8.2.2 Cabinet Installation

Place the UPS modules side by side and interconnect as shown in **Figure 8.1** on the next page. The output distribution mode (Q1 and Q2 must be configured) shown in **Figure 8.1** on the next page is recommended to facilitate maintenance and system testing.

Figure 8.1 Schematic of Typical Parallel System with Common Input, Separate Batteries, and Output

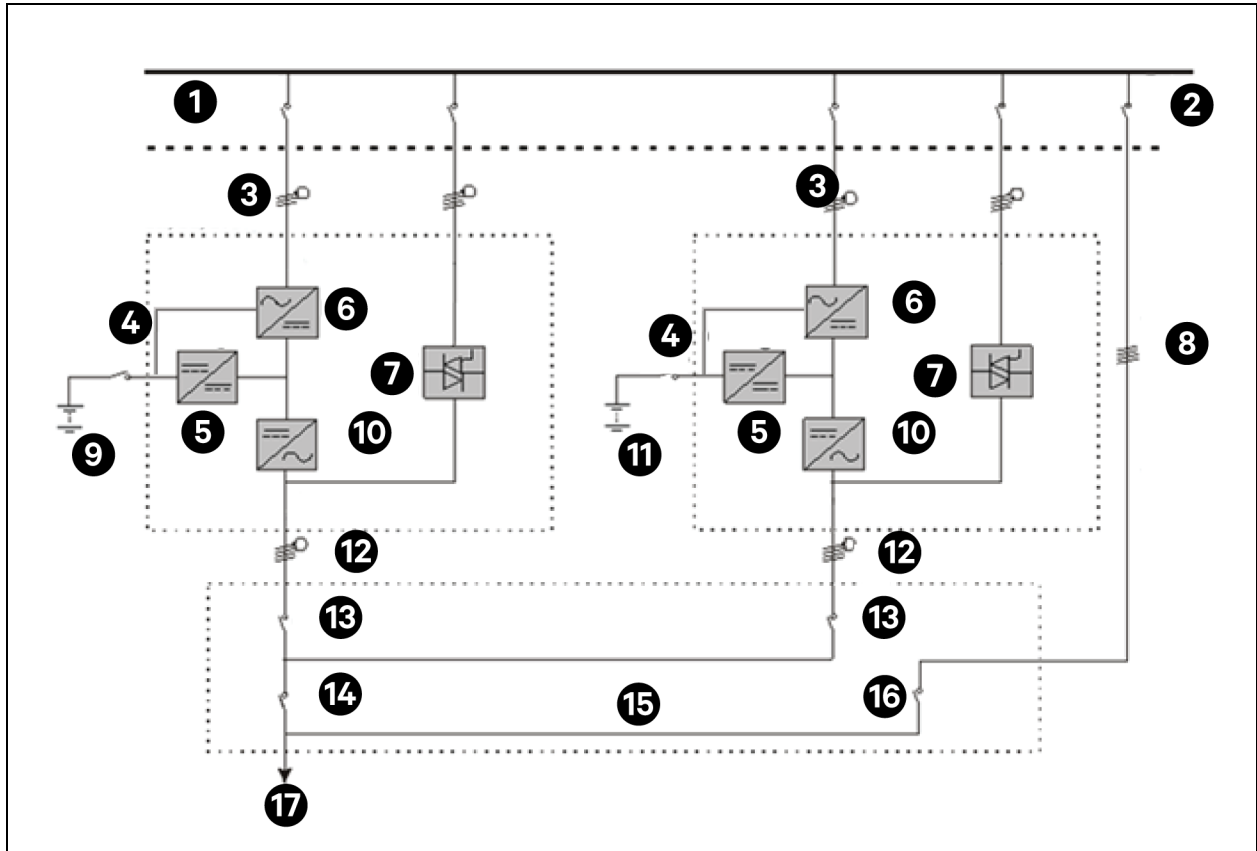

Item	Description	Item	Description
1	Input power supply	10	Inverter
2	External bypass switch	11	Battery 2
3	Mains input L1, L2, and L3	12	L1, L2, and L3
4	BCB	13	Q1 and Q2 ext
5	Charger	14	QOP
6	Rectifier	15	Output distribution
7	Static switch	16	QBP
8	External maintenance bypass	17	To load
9	Battery 1		

8.2.3 External Protective Device



WARNING! High earth leakage current. Earth connection is essential before connecting the input supply (including both mains supply and battery). The equipment must be earthed in accordance with the local electrical regulations.

8.2.4 Power Cable

The power cable of dual bus power system is similar to that of single system. See [Power Cable Wiring](#) on page 31 for more information.

The bypass and rectifier input supplies must use the same neutral line input terminal. If the input has a current leakage protective device, the device should be installed with upstream of the neutral line input terminal.

8.2.5 Parallel Cable

The cables must be interconnected in a ring-shaped connection between the UPS modules, as shown in **Figure 8.2** on the next page. The ring connection ensures the reliability of the control of the parallel system.

NOTE: Shielded and double insulated parallel cables are available in lengths of 16.4 ft., 32.8 ft., and 49.2 ft. (5 m, 10 m, and 15 m).

The specific connection method is the parallel cable of one single UPS is connected from the PARA1 port of the communication box to the PARA2 port of the immediate next single machine communication box and is in sequence. The front panel of the communication module provides parallel ports, as shown in **Figure 8.3** on the next page. Make sure to check all the reliable cable connections before starting up the UPS system.

Figure 8.2 Parallel Signal Cables Connection (Parallel System)

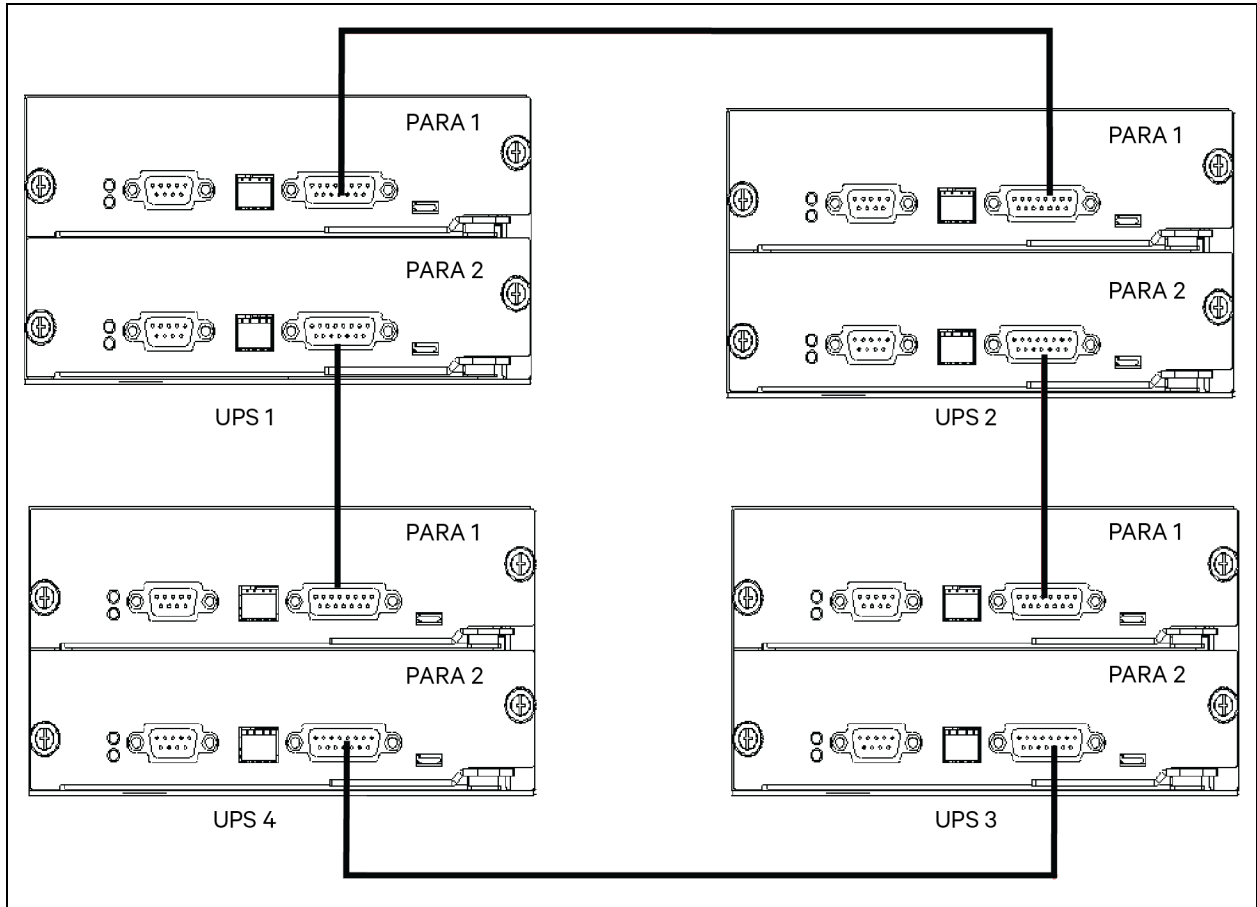
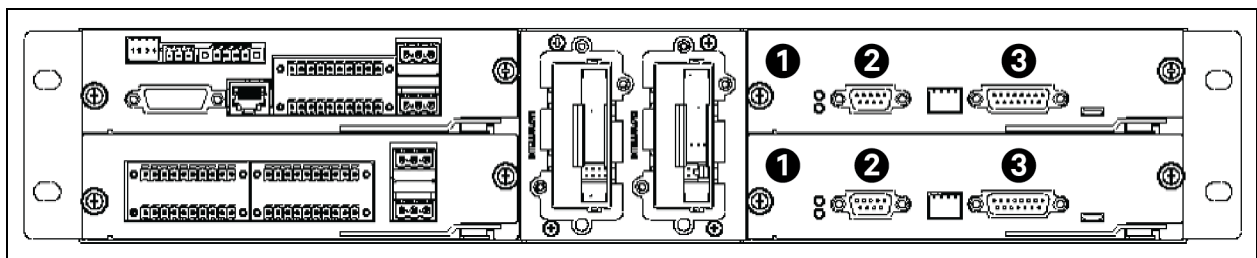

Figure 8.3 Parallel Port on the System Control Module



Item	Description
1	U4
2	LBS
3	Parallel

8.2.6 Remote Emergency Power Off

In addition to the remote emergency power off (REPO) switch provided on the operator control and display panel of each UPS module for controlling the REPO of each module respectively, the parallel system also provides remote REPO function for controlling all UPS modules to shutdown simultaneously from a remote terminal, as shown in **Figure 8.4** on the facing page.

NOTE: The remote EPO switch must provide dry contact signal, which is normally open or normally closed. The open circuit voltage provided is 12 VDC, <20 mA.

NOTE: The external EPO device consists of another control system which can disconnect UPS mains supply or bypass input. Pins 1 and 2 of the normally closed EPO port on the integrated control module is linked in factory.

Figure 8.4 REPO Circuit Diagram

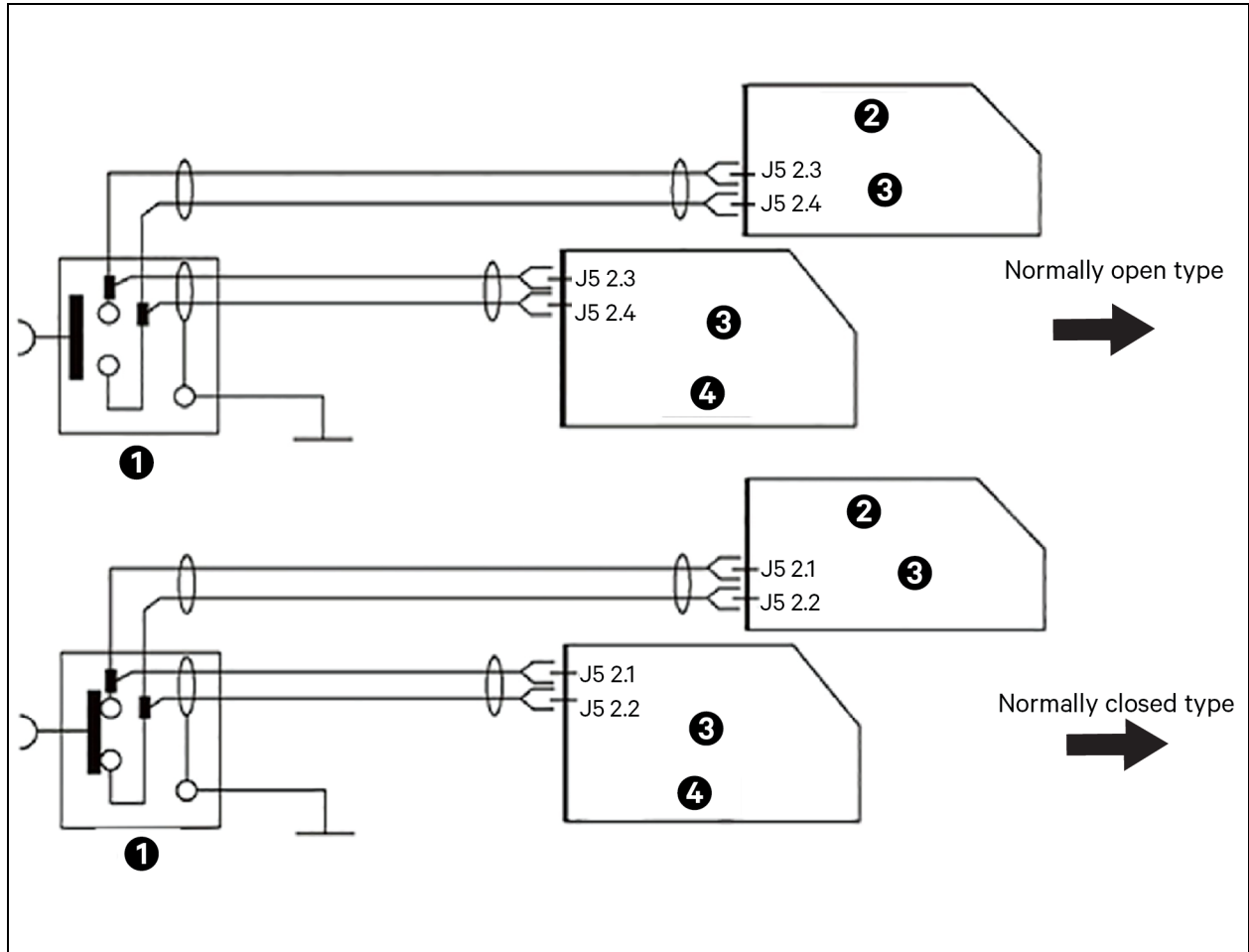

Item	Description
1	EPO switch
2	UPS 2
3	Integrated control module
4	UPS 1

NOTE: In Figure 8.4 above, the upper one is normally open type, and the lower one is normally closed type.

8.3 Operation Procedures for Parallel System

Only one step is required at a time, and the subsequent step may only be completed when this operation step of each UPS module has been completed.

8.3.1 Start-up Procedures in Normal Mode

These procedures are applicable to start the UPS under total power down state, which means the UPS or the maintenance bypass switch has not supplied the load before. Make sure UPS has been completely installed and commissioned by authorized engineer, and external power supply switch has been turned off.

NOTE: Place a LOTO at the AC input distribution (generally far away from the UPS) to alert that the UPS maintenance is being operated.



WARNING! These procedures result in mains voltage being applied to the UPS output terminals. If any load equipment is connected to the UPS output terminals, check that it is safe to apply power. If the load is not ready to receive power, open the downstream load switch and place a warning label on the connection point of the load.

Procedure to turn on the UPS from a fully powered down condition:

1. Close all external output isolating switches (if any) of each UPS.

When the above steps are complete, the system is powered on, and the start-up screen pops up.

Wait 25 seconds and confirm that the touchscreen shows that the rectifier power supply and the bypass power supply are normal.

If not, check whether the RIB and BIB breakers are closed. Then the rectifier starts up, about 30 seconds after the rectifier enters normal operation, the bypass static switch is closed.

2. When the rectifier start process is finished and the rectifier indicator turns solid green, close the external BCB.
3. For each UPS, manually turn on the inverter. The inverter starts up, the whole UPS system will power the load.

8.3.2 Procedures for Isolating One UPS Module from Parallel System

IMPORTANT! The isolation procedures should be carried out only by Vertiv certified service personnel.

NOTE: Isolating a UPS module from a parallel system should only be performed if the remaining UPS modules can support the load. If not, the recommendation is to place the load on to a maintenance bypass source.

To isolate the UPS module from the parallel system, follow the steps below:

1. Turn off the inverter with the OFF button on the GHMI.

NOTE: Turning off the rectifier, inverter, static switch, and battery will not affect other UPS units in the parallel system and the load remains powered normally.

2. Disconnect the external power mains switch, external power bypass switch, BCB and single UPS external output switch.

NOTE: Place a LOTO at the AC input distribution (generally far away from the UPS) to alert that UPS maintenance is being performed.

NOTE: Wait 10 minutes for the internal DC bus capacitance to discharge. Then the UPS is completely shutdown.

8.3.3 Procedures for inserting one isolated UPS module in parallel system

IMPORTANT! These procedures shall only be carried out by service personnel of Vertiv or under their guidance.

The following procedures are used to reintegrate a UPS module that has been previously isolated from the parallel system:

1. Confirm that the I/O cable, battery cable and parallel cable of the single module are correctly connected.
2. Close the external output switch, external power bypass switch, and external power mains switch of each UPS in turn.
3. When the single module starts, close the BCB and then manually turn on the inverter.

Wait for few seconds after starting the inverter the UPS system, it connects with existing systems for parallel operation automatically.

8.3.4 Adding a Single Module UPS to a Parallel System Supporting Load

1. Connect the external power mains switch, external power bypass switch, BCB and single UPS external output switch.
2. Wait for all the modules in the UPS being added, to start with all rectifiers running.
3. Turn on the Inverter with the ON button on the GHMI.

8.3.5 Procedures for Completely Powering Down a Multi-Module UPS System

Follow this procedure to completely shutdown the UPS. Load power must be off. Disconnect all power switches, isolation switches, and breakers so that the UPS no longer supplies power to the load.

1. If Load must be maintained, transfer to static bypass on all UPS systems.
2. Close the Maintenance Bypass breaker for all UPS systems.
3. Press the remote EPO button of each UPS to stop the operation of rectifier, inverter, static switch, and battery.
4. Disconnect the external power bypass switch and external power mains switch. At the moment, all the internal power supply is closed, and the touchscreen does not display any more.
5. Disconnect the external output switch.



WARNING! Hazardous battery voltage. The battery terminals have hazardous voltage even after the UPS complete shutdown.

NOTE: Wait 10 minutes while the internal DC bus capacitance discharging. Then the UPS is completely shutdown.

NOTE: Place a LOTO at the AC input distribution (generally far away from the UPS) to alert that the UPS maintenance is being performed.

8.4 LBS System

8.4.1 Cabinet Installation

An LBS system consists of two independent UPS systems, each containing one or more parallel UPS modules, as shown in **Figure 8.5** on the next page and **Figure 8.6** on page 101. The LBS system is highly reliable and applicable to the load with multiple inputs. For single input load, a STS can be installed to feed power to the load.

The system uses the LBS cables to keep the output of two independent UPS systems in synchronization. One set of UPS system (single/parallel) is designated as the primary, the other set of UPS system (single/parallel) is designated as the secondary for the operation in LBS mode.

Figure 8.5 LBS System (UPS Module)

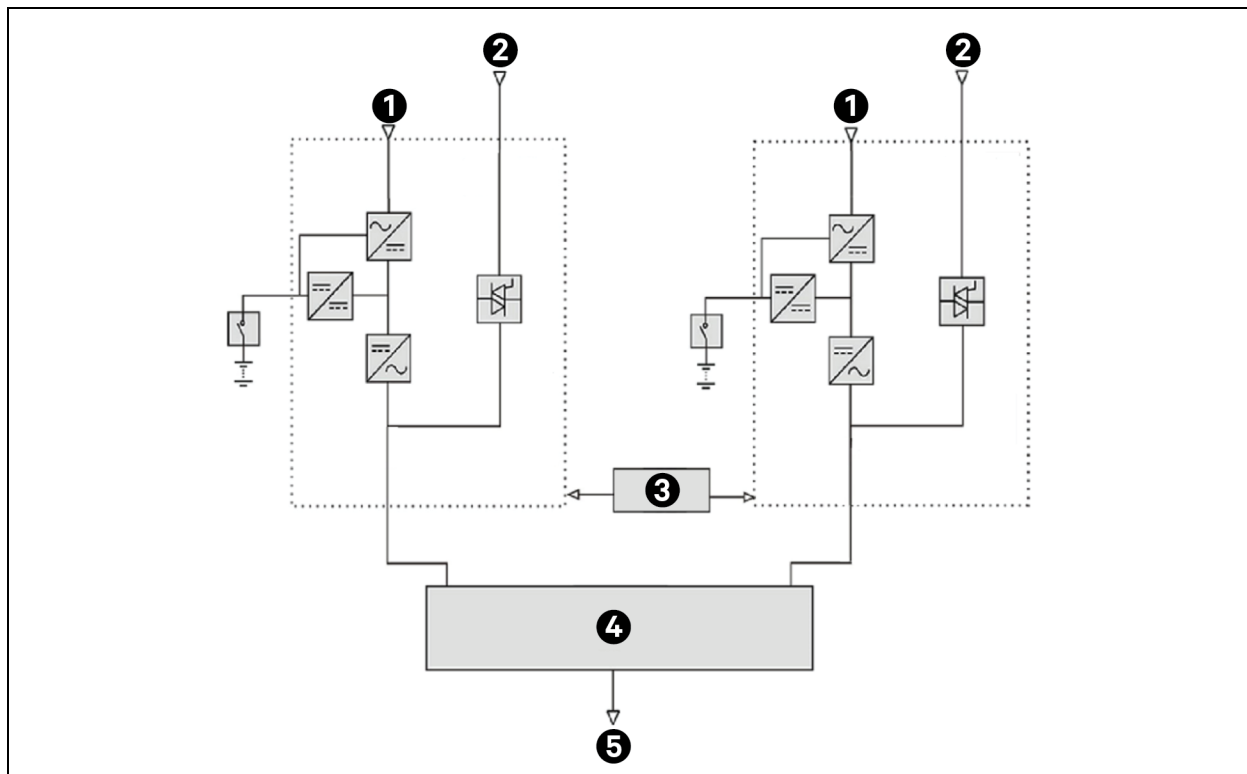

Item	Description	Item	Description
1	Rectifier	4	STS
2	Bypass	5	To load
3	LBS		

Figure 8.6 LBS System (Parallel System)

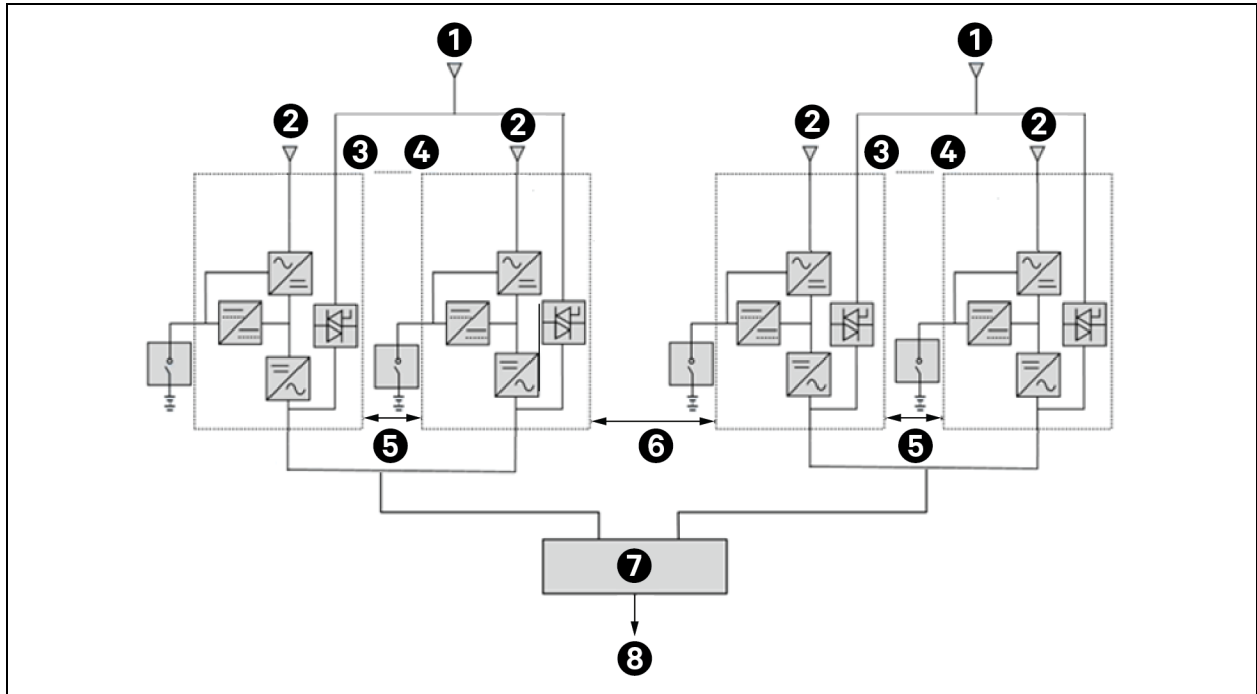

Item	Description	Item	Description
1	Bypass	5	Parallel cable
2	Rectifier	6	LBS
3	UPS1	7	STS
4	UPS4	8	To load

NOTE: In a dual bus system, the two UPS systems must have the same voltage and frequency, and the load must not exceed the power rating of a UPS module system.

8.4.2 External Protective Device

See [External Protective Devices](#) on page 37.

8.4.3 Power Cable

The power cable of dual bus power system is similar to that of single system. See [Power Cable Wiring](#) on page 31 for more information.

The bypass and rectifier input supplies must use the same neutral line input terminal. If the input has a current leakage protective device, the device should be installed with upstream of the neutral line input terminal.

8.4.4 LBS Cable

Connect the optional LBS cables 32.8 ft., 49.2 ft., and 65.5 ft. (10 m, 15 m, and 20 m) between the LBS ports or PARA2 and LBS port of the two UPS systems, for dual bus system, shown in [Figure 8.7](#) on the next page and [Figure 8.8](#) on page 103. The LBS port is shown in [Figure 8.9](#) on page 104.

NOTE: You must use the shortest LBS cable suitable for the application. Do not coil excess. Separate the LBS cable from the power cables to prevent electrical interference.

Figure 8.7 Connection of Typical LBS System (Single Module)

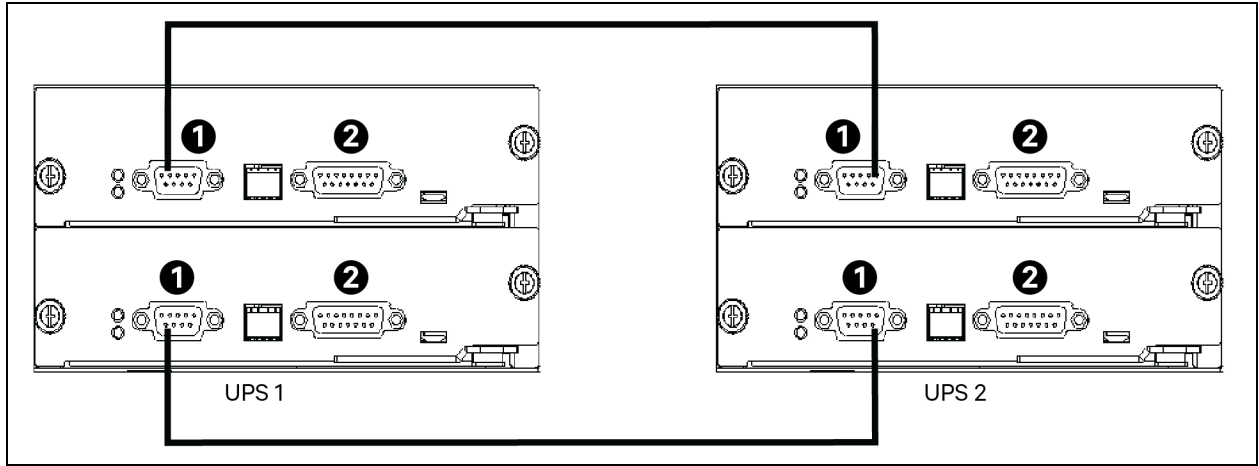

Item	Description
1	LBS
2	Parallel

Figure 8.8 Connection of Typical LBS System (Parallel System)

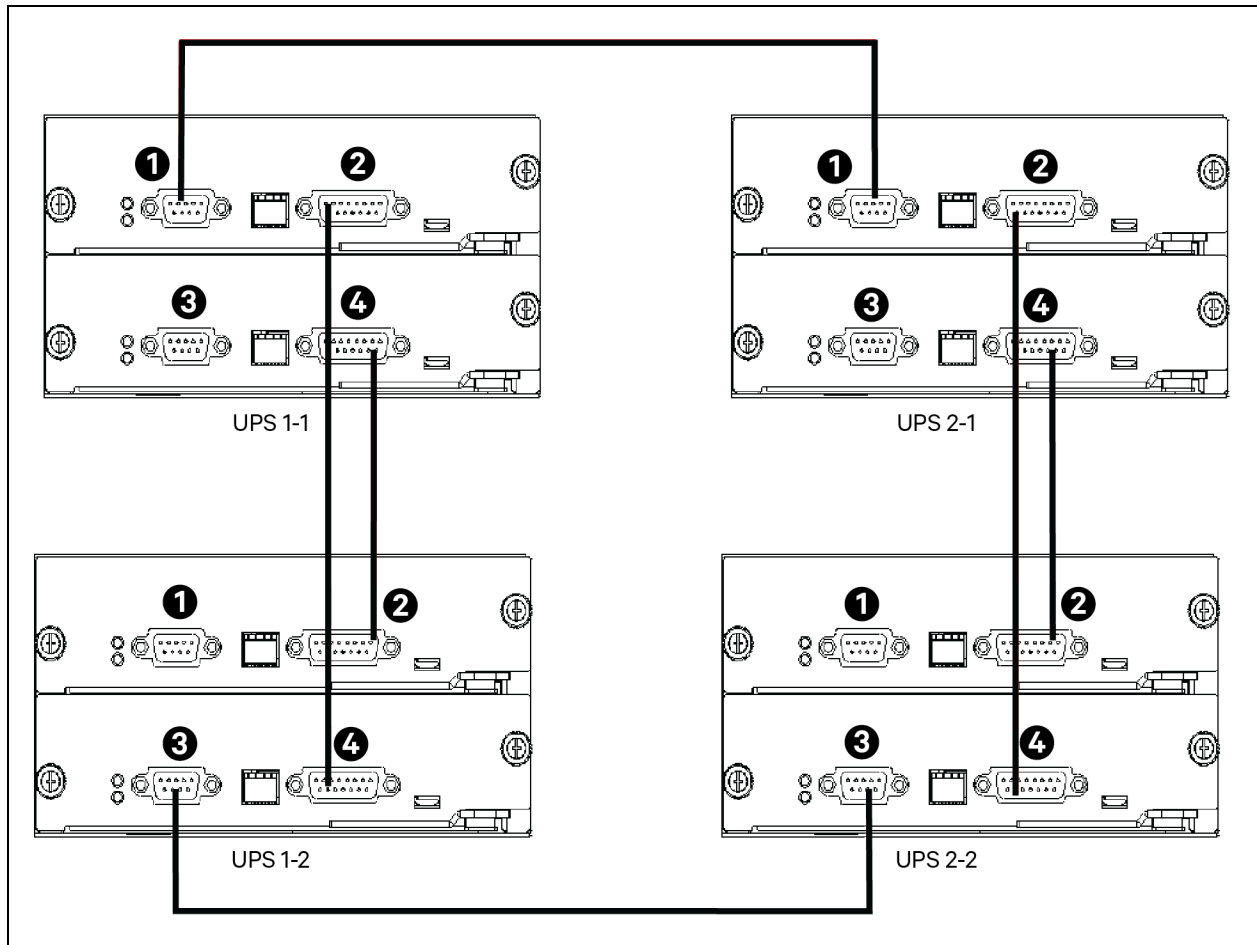

Item	Description
1	LBS1
2	Parallel 1
3	Parallel 2
4	LBS2

Figure 8.9 LBS Port

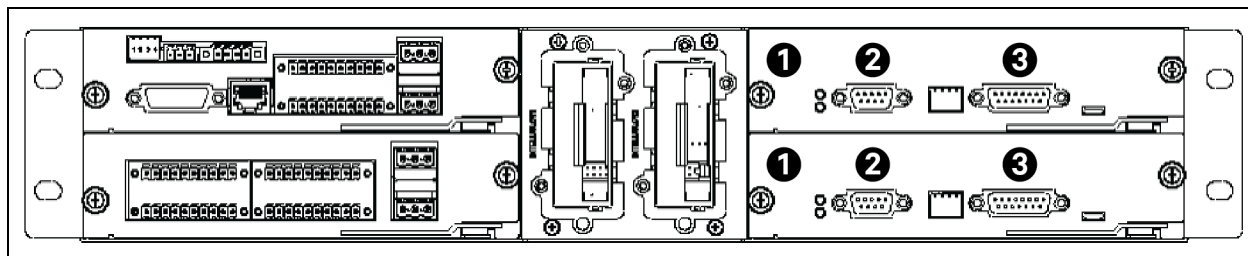

Item	Description
1	U4
2	LBS
3	Parallel

9 Vertiv™ PowerUPS 9000 1250 kVA Modular UPS Option Configurations

This chapter provides information about available options for the PowerUPS 9000 1250 kVA Modular UPS.

9.1 Options List

Table 9.1 Options List

Number	Option Name	Remark
1	Seismic anchor kit	—
2	IS-RELAY card	Vertiv™ Intellislot™ ports 1 to 2
3	RDU120 card	Vertiv™ Intellislot™ ports 1
4	LBS extender	—
5	Parallel cable	Available in 16.4 ft., 32.8 ft., and 49.2 ft. (5 m, 10 m, and 15 m)
6	LBS cable	Available in 32.8 ft., 49.2 ft., and 65.5 ft. (10 m, 15 m, and 20 m)
7	Single Input busbar Kit	—
8	Bypass backfeed protection component	—

9.2 Options Introduction

9.2.1 Seismic Anchor Kit

The Vertiv™ PowerUPS 9000 1250 kVA Modular UPS has an optional seismic anchor kits. It helps to avoid and reduce the damage to UPS caused by earthquakes or vibration in earthquake prone areas.

See **Table 9.2** below for dimensions of the seismic anchor kit.

Table 9.2 Dimensions and Content of the Seismic Anchor Kit

Item	Width in. (mm)	Length in. (mm)
Seismic anchor	2.36 (60)	78.74 (2000)
Item	Content	
480V UL cabinet	six seismic anchors	

Table 9.3 Content of the Seismic Anchor Kit

Item	Quantity
M8 × 25 tapping screws	24
M6 × 12 self-tapping locking screws	24
M12 expansion screws	18

Table 9.3 Content of the Seismic Anchor Kit (continued)

Item	Quantity
Inclined beam 1	3
Inclined beam 2	3

Fix the UPS onto the concrete floor.



WARNING! Execute the installation according to the instructions. Failure to do so can cause personnel injury or damage to the UPS and seismic anchor kits.

Keep the Seismic Anchor Kit, and one cross head screwdriver, a torque wrench, and an adjustable spanner handy before starting the installation.

Installing the seismic anchor:

1. Use M8 × 25 tapping screws to install seismic anchor on the rear bottom side of the UPS cabinet, then fasten the inclined beam 1 and inclined beam 2 to the lower part of the cabinet with M6 self-tapping locking screw, fasten the seismic anchor to the ground with M12 expansion bolts as shown in **Figure 9.1** below.

Figure 9.1 Seismic Anchor Dimensions for PowerUPS 9000 1250 kVA Modular UPS (Rear Installation)

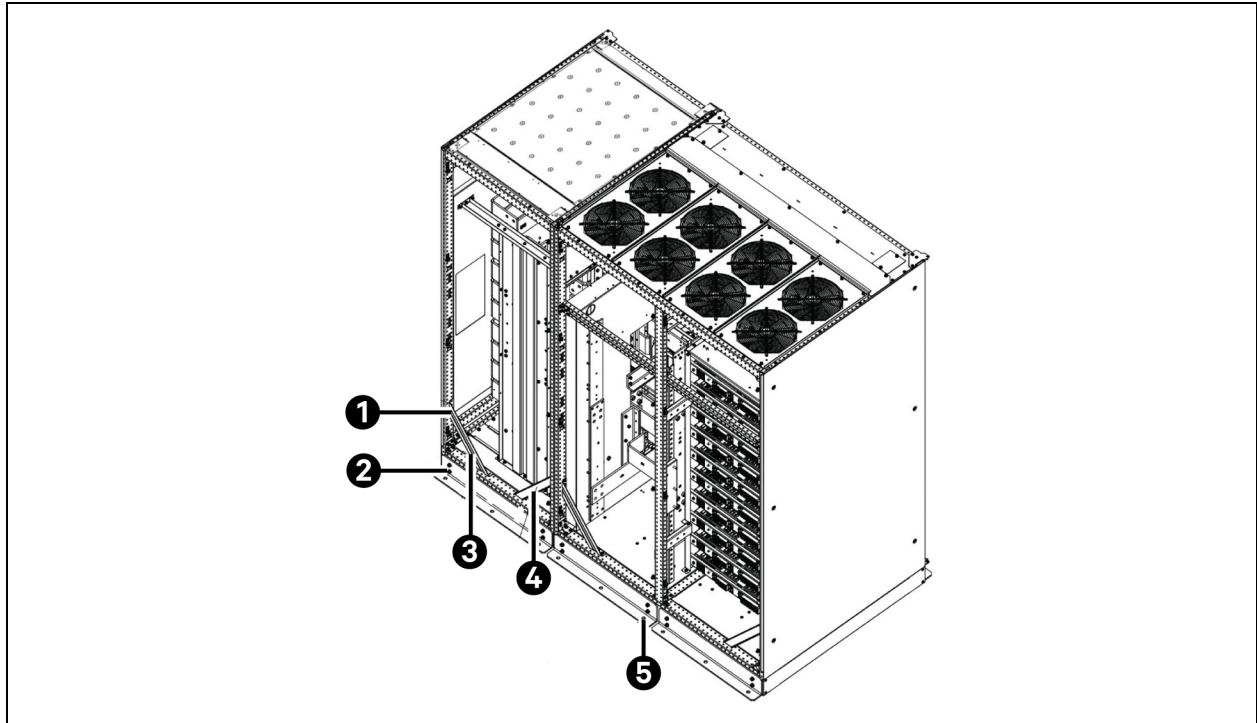

Item	Description	Quantity
1	M6 × 12 self-tapping locking screws	8
2	M8 × 25 tapping screws	12
3	Inclined beam 1	1

Item	Description	Quantity
4	Inclined beam 2	1
5	M12 expansions screws	9

- Use M8 × 25 tapping screws to install seismic anchor on the front bottom of the UPS cabinet. Then fasten the inclined beam 1 and inclined beam 2 to the lower part of the cabinet with M6 self tapping locking screws finally fasten the seismic anchor to the ground with M12 expansion bolts, as shown in **Figure 9.2** below.

Figure 9.2 Seismic Anchor Dimensions for PowerUPS 9000 1250 kVA Modular UPS (Front Installation)

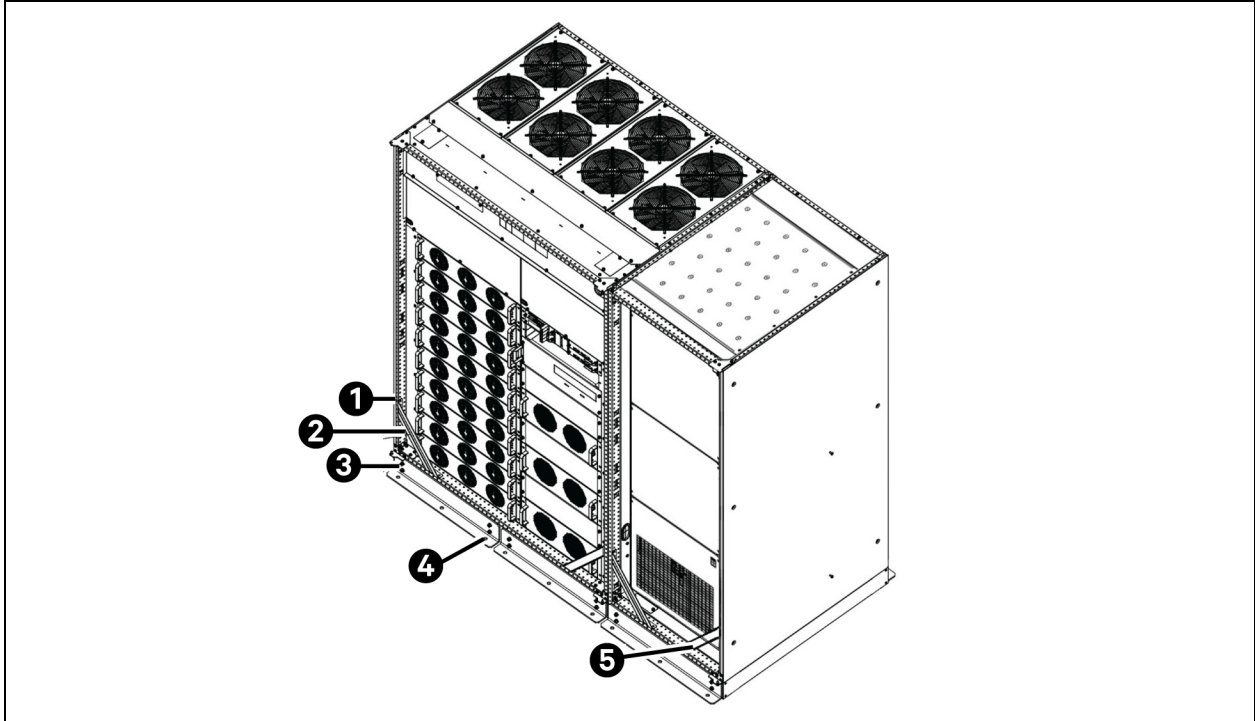

Item	Description	Quantity
1	M6 × 12 self-tapping locking screws	16
2	Inclined beam 1	2
3	M8 × 25 tapping screws	12
4	M12 expansions screws	9
5	Inclined beam 2	2

Figure 9.3 Seismic Anchor Dimensions for PowerUPS 9000 1250 kVA Modular UPS (Bottom Installation)

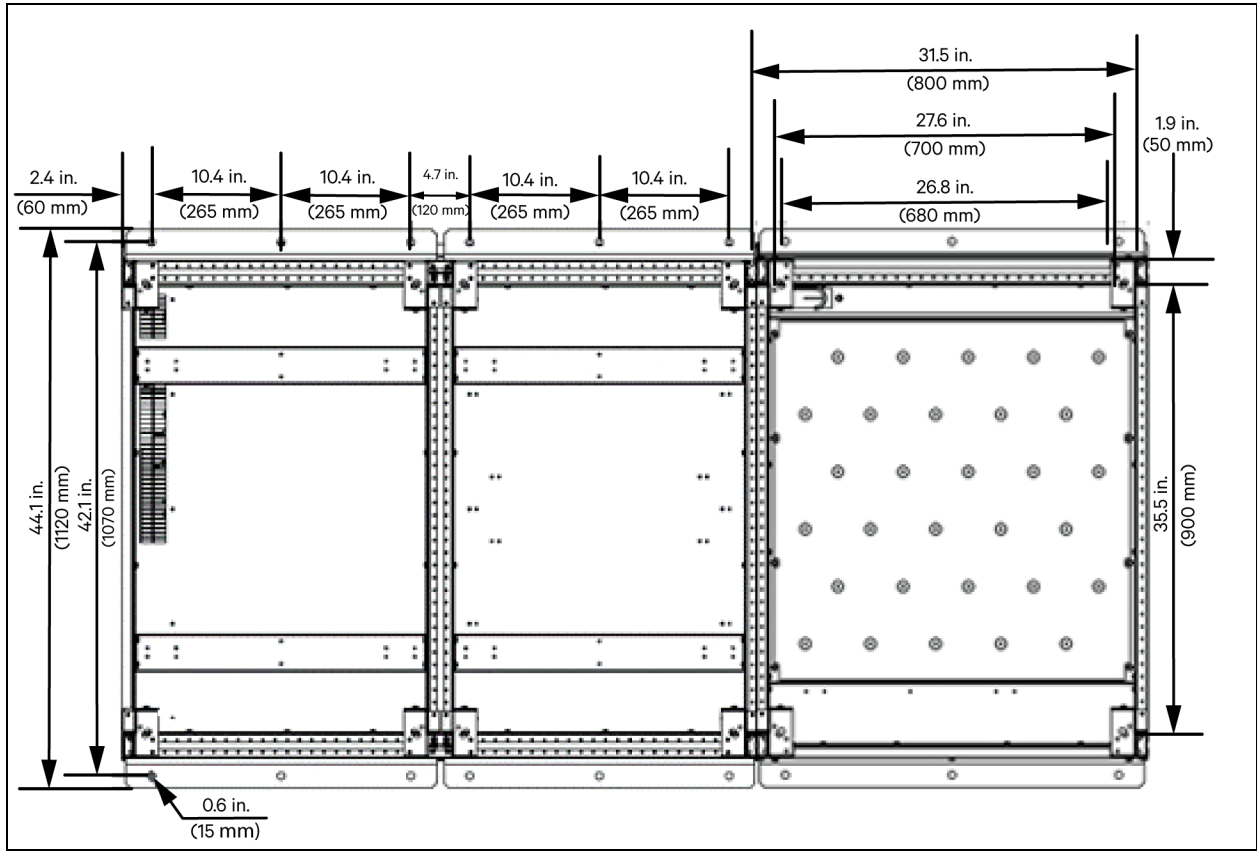

9.2.2 Vertiv™ Liebert® IntelliSlot™ IS-Relay card

Vertiv™ PowerUPS 9000 1250 kVA Modular UPS has an optional Liebert® IS-Relay card to use the dry contact signal to monitor the UPS functionalities. The functions of the IS-Relay card are listed in **Table 9.4** on the facing page. See **Figure 9.4** on the facing page for more information of IS-Relay card.

Figure 9.4 IS-Relay



Table 9.4 Function of UPS IS-Relay card

Pin	Function	Operation
1	Common-Low Battery	—
2	Low Battery	Closed if low battery point occurs
3	Low Battery	Closed if battery is OK
4	Common-UPS Fault	—
5	UPS Fault	Closed if UPS fault occurs
6	UPS Fault	Closed if no UPS failure
7	Common-On Battery	—
8	On Battery	Closed if On Battery power (Utility failure)
9	On Battery	Closed if not On Battery power (Utility OK)
10	Signal Ground	Future release
11	Signal Ground	Future release
12	UPS Any-Mode Shutdown	Future release
13	Summary Alarm	Closed if no alarm conditions are present
14	Summary Alarm	Closed if summary alarm occurs
15	Common-Summary Alarm	—
16	On UPS	Closed if On UPS (inverter) power
17	On Bypass	Closed if On Bypass
18	Common-On Bypass	—

For more information of the Liebert® IntelliSlot™ IS-Relay card, refer to the **Vertiv™ Liebert® IntelliSlot™ IS-Relay Card User Manual_ SL-52645**.

See [Signal Cable Connection Steps](#) on page 53 for the cabling and routing of the signal cables.

9.2.3 Vertiv™ Liebert® IntelliSlot™ RDU120 Card

The Vertiv™ Liebert® IntelliSlot™ RDU120 card provides Web access to UPS devices and transfers data over SNMP, Modbus, and BACNet. Environmental sensor data access is provided through Web and SNMP. The RDU120 card uses an Ethernet network to monitor and manage various operating parameters, alarms, and notifications.

Figure 9.5 below shows the appearance of the RDU120.

Figure 9.5 RDU120 Card

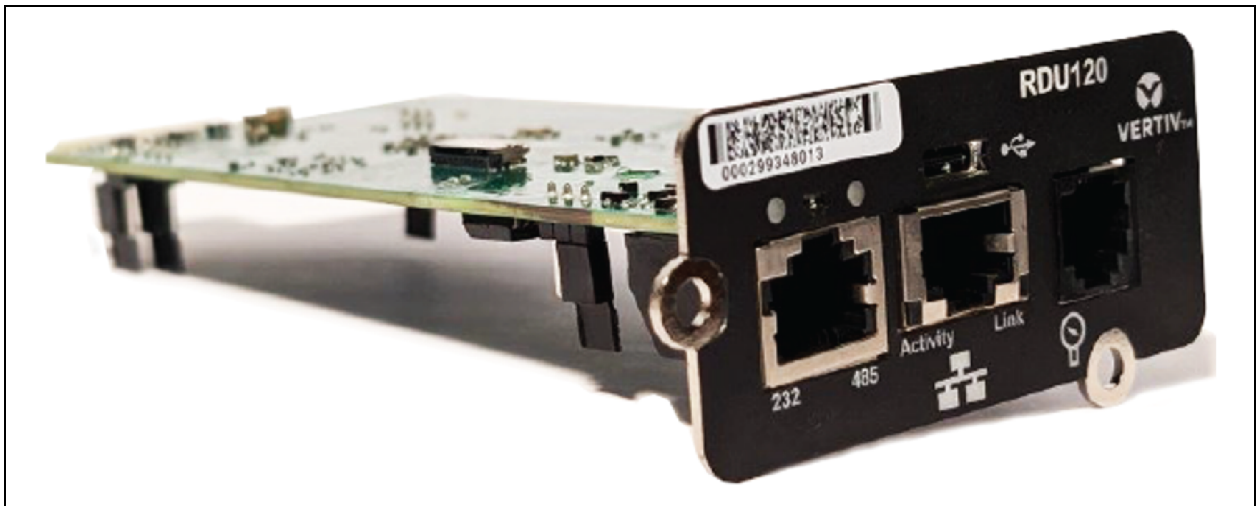

For details, refer to **Liebert® IntelliSlot™ RDU120 User Manual SL-52645**.

See the [Signal Cable Connection Steps](#) on page 53 for the cabling and routing of the signal cables.

9.2.4 Parallel Cable

Connect a module parallel cable from its PARA1 port to the PARA2 port of another module. Similarly connect other parallel cables.

Shielded and double insulated parallel cables available in lengths of 16.4 ft., 32.8 ft., and 49.2 ft. (5 m, 10 m, and 15 m) must be interconnected in a ring configuration between the UPS modules, as shown in **Figure 8.2** on page 96.

The ring connection ensures the reliability of the control of the parallel system. Verify the cable connection before starting up the UPS system.

9.2.5 LBS Cable

Shielded and double-insulated parallel control cables (LBS1 and LBS2) available in lengths of 32.8 ft., 49.3 ft., and 65.7 ft. (10 m, 15 m, and 20 m). The LBS cable must be interconnected in a branch configuration between LBS1 and LBS2 of any UPS modules, as shown in **Figure 8.7** on page 102, **Figure 8.8** on page 103, and **Figure 8.9** on page 104.

9.2.6 LBS Extender

The LBS Extender as shown in **Figure 9.6** below is designed to extend the LBS function up to 492.12 ft. (150 m) between the 2 UPS units or systems of a dual bus system, and it also enables an Vertiv™ PowerUPS 9000 1250 kVA Modular UPS to synchronize with other UPS models.

Figure 9.6 LBS Extender

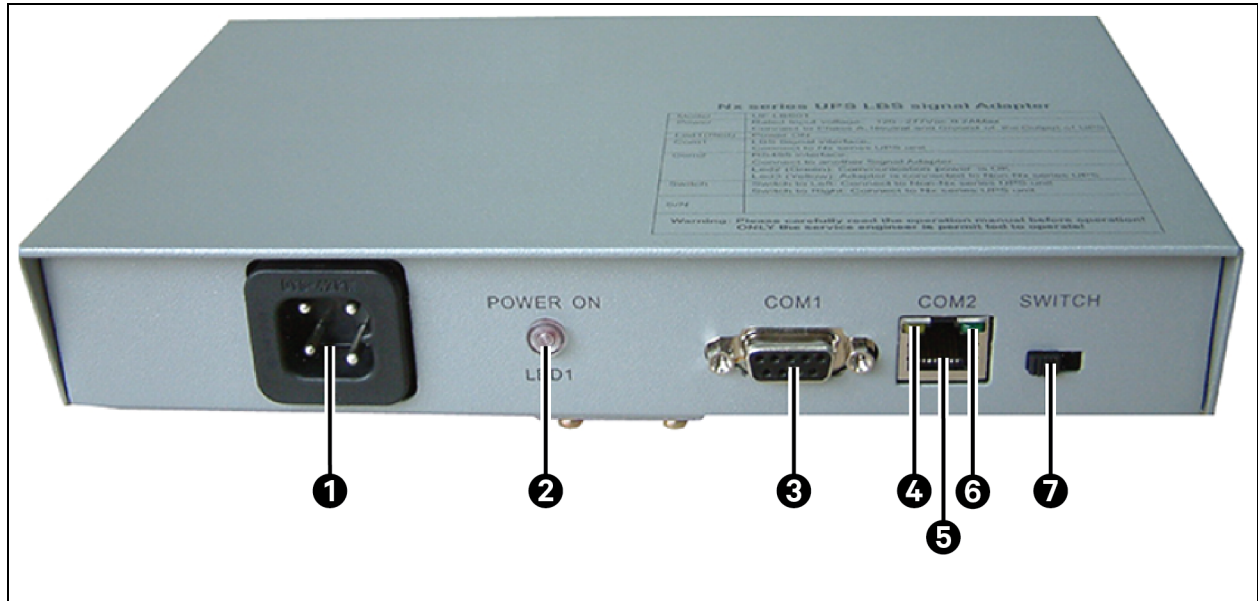

Item	Description	Item	Description
1	Power Port	5	COM2
2	LED1	6	Green LED
3	COM1	7	Switch
4	Yellow LED		

For details about how to install and connect cables, refer to [Dual Bus UPS LBSTM Expander/Adapter Installation Manual_SL-71071](#).

9.2.7 Single Input Busbar Kit

For the UPS with single Input busbar of common input configuration, the user should select the single Input busbar Kit to short the mains input and bypass input.

9.2.8 Bypass Backfeed Protection Component (Optional)

A bypass backfeed disconnect (BFD) contactor is provided as an option. The contactor is installed inside the IO cabinet and is directly powered by the input power supply. When the input power is off, the contactor is disconnected. See **Figure 9.7** on the next page for the specific location.

NOTE: If the BFD option is not present, the customer must have a remote backfeed breaker (RBB) that can be controlled by a shunt trip mechanism through a programmable dry output from the UPS controls. Additionally, there is an option to include a power supply for the RBB to facilitate shunt trip control.

Figure 9.7 Bypass Backfeed Protection Component for 480 V

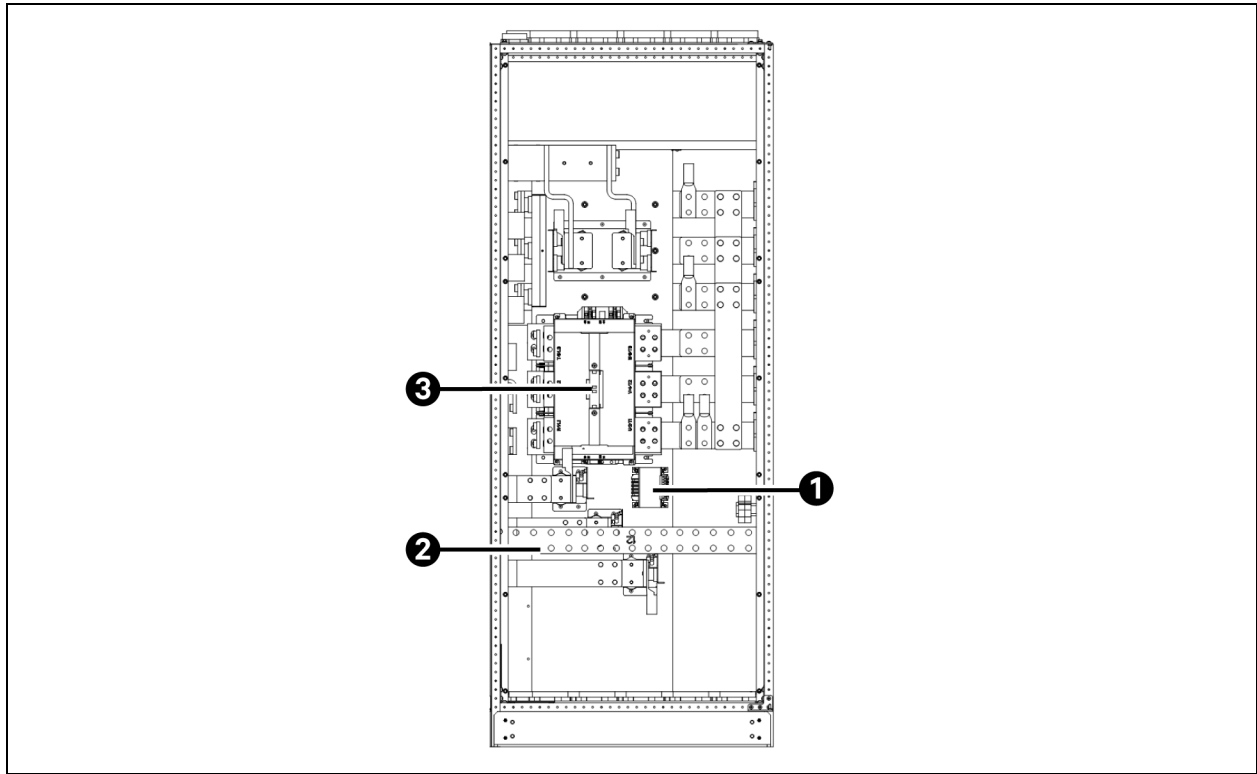

Item	Description
1	Transformer
2	PE
3	BFD

10 Communication

This chapter provides information about the compatible communication protocols.

Vertiv™ PowerUPS 9000 1250 kVA Modular UPS Supports:

- SNMP Protocol communication
- Modbus protocol communication
- Dry contact communication

10.1 SNMP Protocol Communication

Vertiv's RDU120 support SNMP protocol that helps to monitor the UPS through network.

IRM series sensor can also be connected to Vertiv™ Liebert® IntelliSlot™ RDU120 card to provide environmental monitoring function. When the intelligent equipment generates an alarm, the RDU120 card can notify the user by recording the log, sending trap information, and trigger mails.

The RDU120 card provide three approaches for you to monitor your intelligent equipment and equipment room environment:

- Using web browser. Through the Web server function provided by RDU120 card.
- Using Network Management System (NMS) through the SNMP function provided by the RDU120 card.

The RDU120 card shall be installed at the IntelliSlot port. See **Figure 4.7** on page 45 for more information of position of various communication card. For detailed information on installation and setup of the RDU120 card, refer to **Vertiv™ Liebert® IntelliSlot RDU120 Card User Manual**.

10.2 Modbus Protocol Communication

The Modbus (RTU) protocol communication is supported by the RDU120 card.

10.3 Dry Contact Communication

The UPS provides the following two dry contact communications:

- IS-Relay card (Optional)
- Dry contact port of central control module

10.3.1 Communication through IS-Relay Card

The UPS provides an Liebert® IS-Relay card user to use dry contact signals to monitor the UPS. For the installation and use of the IS-Relay card, refer to **Vertiv™ Liebert® IntelliSlot™ IS-Relay Card User Manual_SL-26100**.

10.3.2 Communication through Dry Contact Port of Central Control Module

For field specific needs, the UPS may need auxiliary connection to have functions such as acquiring external equipment status information, providing alarm signals to external devices, and remote EPO. These functions are realized through the following interfaces on the bypass control module:

- Input dry contact port status information.
- Output dry contact ports of alarm signal.

- EPO input port.

For the functions and detailed information of these ports, see [Wiring of Signal Cable](#) on page 45.

11 Service and Maintenance

The UPS system (including the battery) requires periodic service and maintenance to ensure long service life. This chapter provides information about the service life, regular inspection, maintenance, and replacement of the key UPS components.

NOTE: Effective maintenance of the UPS system can reduce the risk of UPS failure and will increase the UPS service life.

11.1 Safety for Service and Maintenance



WARNING! Replacement, service, and maintenance is to be performed only by authorized Vertiv personnel to prevent device malfunction.



WARNING! The neutral line has hazardous voltage. When servicing the UPS, use caution to prevent accidental injury or death. Use personal protective equipment.



WARNING! If the USP does not have a switch or if it has 3 switches, switch off the disconnect device before maintenance, and check whether the UPS is powered on.



WARNING! The components that can only be accessed by opening the protective cover with tools cannot be operated by the user. Only qualified service personnel are authorized to remove such covers.

11.2 Service Procedures of Power Module and Bypass Power Module

NOTE: Only Vertiv service engineers are to service power modules and bypass power modules.

1. Remove the power modules and bypass power module from top to bottom to prevent cabinet toppling due to high gravity center.
2. Do not disassemble the power module, bypass power module, and central control module. They may have high voltage inside.
3. Service the power modules and bypass power modules after 5 minutes of unplugging from power source.
4. Put the modules back into the cabinet after 5 minutes after servicing.
5. Do not pull different types of modules out of the cabinet at the same time.

11.3 Key Components and Service Life of UPS

When in use, some components of UPS system will have shorter service life compared to the UPS due to abrasion. For the safety of the UPS supply system, it is necessary to have regular inspection and replacement of these components. This section introduces the key components of UPS and the reference years of service life. For systems under different conditions (environment or load rate) assessment and advice by service engineers on whether to replace the device are required with reference to the information provided in this section.

11.3.1 Life Parameters and the Proposed Replacement Time of Key Components

Key components in **Table 11.1** below are used in the UPS system. To prevent system failures due to some device failure by wear, it execute the regular inspection and replacement during its estimated life.

Table 11.1 Life Parameters and the Recommended Replacement Time of Key Components

Key Components	Estimated Life	Proposed Replacement Time	Proposed Inspection Period
Fan	Not less than 7 years	5 years to 6 years	1 year
Air filter	1 year to 3 years	1 year to 2 years	2 months
VRLA battery (5-year life)	5 years	3 years to 4 years	6 months
VRLA battery (10-year life)	10 years	6 years to 8 years	6 months

11.3.2 Replacement of Air Filter

NOTE: The air filters need regular inspection and replacement, which depends on the environmental conditions of the UPS. Under normal environmental conditions, the air filters should be cleaned or replaced once every two months and need more frequent cleaning and replacement in dusty or other unclean environments.

The UPS has air filters mounted on the rear side of the front door of the cabinet. The filters can be replaced while the UPS is operational.

The air filters are fixed by bars on both sides. See **Figure 11.1** on the facing page for location of filter.

To replace the air filters:

1. Open the front door of the UPS.
2. Loosen the screws to remove one of the fixing bars while leave the other bar as it is.
3. Replace the clean air filter.
4. Reinstall the fixing bar and tighten all the fixing screws.

Figure 11.1 Replacing Air Filter

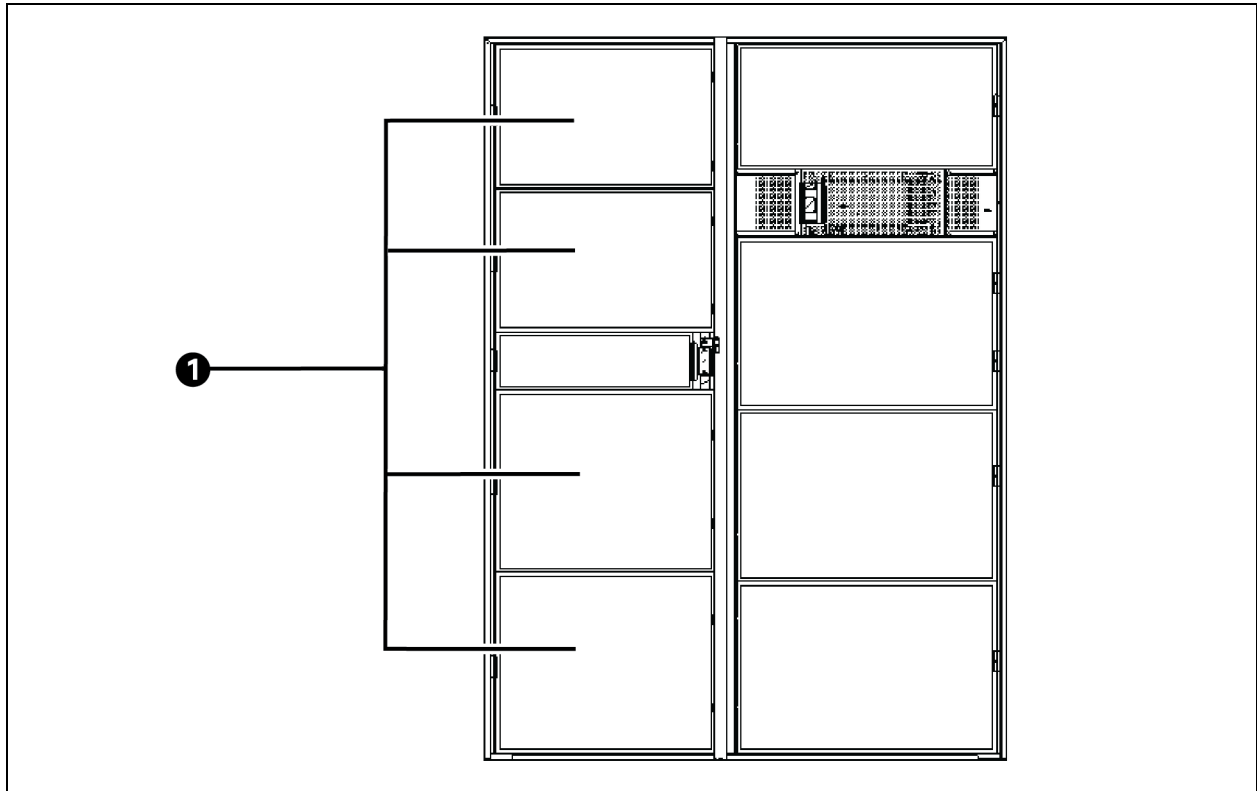

Item	Description
1	Air filter

11.4 Maintenance of UPS and Options

UPS and the options need common maintenance:

1. Keep good maintenance records. Keeping good maintenance records facilitates failure treatment.
2. Keep the surrounding environment clean to prevent dust and moisture entering the UPS.
3. Maintain an ambient temperature of 68 °F to 77 °F (20 °C to 25 °C) for the battery.

NOTE: Very low temperature will reduce the battery capacity and if it is too high the battery life will reduce.

4. Check all wiring regularly for damage.
5. Check and tighten all the screws and tighten all the screws, at least once a year.
6. Check regularly for any abnormality in the upstream or downstream switch to maintain reliability when cutting off the input or output when the current is too large.
7. Regularly check the status of the LED light on the built in lightning protection board of the UPS. If the indicator light is abnormally off, replace the lightning protection board. See Power switch for the position of the lightning protection board.

Maintenance staff should be familiar with the typical ambient conditions where UPS is working in order to rapidly position which ambient conditions are unusual. The setting of UPS touchscreen should be known to all maintenance staff.

For information of the UPS battery maintenance, see Battery Maintenance.

This page intentionally left blank

12 Specifications

This chapter includes all the required UPS specifications.

12.1 Conformance and Standards

The Vertiv™ PowerUPS 9000 1250 kVA Modular UPS has been designed to conform to the following standards:

- Safety UL 1778, 5th Edition, CSA 22.2 107.3-14.
- FCC PART 15-RADIO FREQUENCY DEVICES, Subpart B, CLASS A.
- Transportation ISTA 3B
- ISO 9001
- ICC-ES AC156
- OSHPD

The PowerUPS 9000 1250 kVA Modular UPS has UL and cUL approval.

The PowerUPS 9000 1250 kVA Modular UPS is ENERGY STAR certified satisfying ENERGY STAR Program Requirements Product Specification for Uninterruptible Power Supplies (UPS) - Eligibility Criteria, Version 2.0.

12.2 Environmental Characteristics

Table 12.1 Environmental Characteristics

Item	Normative Reference	Rated Power (kVA)
		1250 kVA 480 V
Noise within 3.3 ft. (1 m) (in the front)	dB (A)	<79 dB at 100% load
Altitude	m	≤ 3000; derate power by 1% per 100 m between 1500 m and 3000 m
Relative humidity	%RH	0 to 95%, non-condensing
Operating temperature	°C	0 to 40, at full load; 41 to 45, 90% load; 46 to 50, 80% load
Storage and transportation temperature for UPS	°F (°C)	Storage: -13 °F to 131 °F (-25 °C to +55 °C), Transportation: -40 °F to 158 °F (-40 °C to +70 °C)
Pollution level		Level 2
Grid system		TN, TT, IT, TN-S

12.3 Mechanical Characteristics

Table 12.2 Mechanical Characteristics

Item		Unit	Rated Power (kVA)
			1250 kVA 480 V
Power module Dimensions (W × D × H)	Packing excluded	in. (mm)	22.9 x 27.5 x 5.2 (580 x 698 x 130)
	Packing included	in. (mm)	31.3 x 38.8 x 13.78 (795 x 985 x 350)
Power module	Net weight	lbs (kg)	143.3 (65)
	Gross weight	lbs (kg)	150 (68)
System Dimensions (W × D × H)	Packing excluded	in. (mm)	82.6 x 39.37 x 78.74 (2100 × 1000 × 2000)
	Packing included	in. (mm)	83.30 x 86.65 x 45.90 (2116 x 2201 x 1166)
	Net weight (not include power module)	lbs (kg)	2323.6 (1054)
	Gross weight (not include power module)	lbs (kg)	2477.9 (1124)
Color		ZP7021	
Protection degree, IEC (60529)		IP20 (front door open or closed)	

12.4 Electrical Characteristics (Input Rectifier)

Table 12.3 Rectifier AC Input (Mains)

Item	Unit	Rated Power (kVA)
		1250 kVA 480 V
Rated AC input voltage	VAC	480 3-wire (3-phase +PE)
Input voltage range	VAC	384 to 528 (full load) 288 to 384 (with derating)
Frequency	Hz	50/60 (range: 40 to 70)
Power factor	kW/kVA, full load (half load)	0.99
Input current	A, rated ³	1962
Total current harmonic distortion (at full load)	%	3
¹ Rectifiers operate at any of the rated supply voltages and frequencies without further adjustment. ² At 305 V input mains the UPS maintains the specified output voltage at rated load without discharging a battery. ³ At rated load, input voltage is 400 V, battery remains fully charged.		

12.5 Electrical Characteristics (Battery Bus)

Table 12.4 Battery

Item	Unit	Rated Power (kVA)
		1250 kVA 480 V
Maximum charging current	A	550 (55 amps per power module)
Quantity of lead-acid cells (nominal)	Block	30 to 50 jars, 40 to 50 jars without derating
Float voltage	V/cell (VRLA)	2.27 (selectable from 2.20 V/cell to 2.30 V/cell) Constant current and constant voltage charge mode
	V/cell (Ni-Cd)	1.45 (selectable from 1.35 V/cell to 1.45 V/cell) Constant current and constant voltage charge mode
	V/cell (Li-ion)	4.2 (selectable from 4.0 V/cell to 4.2 V/cell) for LiMn ₂ O ₄ . 3.45 (selectable from 3.4 V/cell to 3.65 V/cell) for LiFePO ₄ . 4.14 (selectable from 4 V/cell to 4.2 V/cell) for ternary battery. 2.6 (selectable from 2.55V/cell to 2.7 V/cell) for LTO.
Temperature compensation	mV/°C/cl	-3.0 (selectable from 0 to -5.0 around 77 °F (25 °C) or 86 °F (30 °C), or inhibit)
Ripple current	% C10	≤5
Boost voltage	V/cell (VRLA)	2.35 (selectable from 2.30 to 2.40 Constant current and constant voltage charge mode
	V/cell (Ni-Cd)	1.5 (selectable from 1.45 to 1.5). Constant current and constant voltage charge mode
	V/cell (Li-ion)	3.48 (selectable from 3.45 to 3.65) for LiFePO ₄ . Other types are forced to be equal to the float voltage.
Boost control		Float-boost current trigger 0.050C10 (selectable from 0.001 to 0.070) Boost-float current trigger 0.010C10 (selectable from 0.001 to 0.025) 8 hours safety time timeout (selectable from 8 hours to 100 hours) Boost mode inhibit also selectable
EOD voltage	V/cell (VRLA)	EOD Lower Voltage: 1.60 VDC to 1.67 VDC, 1.63 VDC default for lead acid battery. EOD Upper Voltage: 1.67 VDC to 1.85 VDC, 1.75 VDC default for lead acid battery.
	V/cell (Ni-Cd)	EOD Lower Voltage: 0.9 VDC to 1.0 VDC, 1.0 VDC default for Ni-Cd battery. EOD Upper Voltage: 1.0 VDC to 1.1 VDC, 1.0 VDC default for Ni-Cd battery.
	V/cell (Li-ion)	EOD Lower Voltage: 2.9 VDC to 3.4 VDC, 3.15 VDC default for LiMn ₂ O ₄ battery. EOD Upper Voltage: 2.9 VDC to 3.4 VDC, 3.3 VDC default for LiMn ₂ O ₄ battery. EOD Voltage: 2.5 VDC to 2.9 VDC, 2.85 VDC default for LiFePO ₄ battery. EOD Voltage: 2.9 VDC to 3.4 VDC, 2.9 VDC default for ternary battery. EOD Lower Voltage: 1.8 VDC to 2.05 VDC, 1.9 VDC default for LTO battery. EOD Upper Voltage: 1.8 VDC to 2.05 VDC, 2.0 VDC default for LTO battery.

12.6 Electrical Characteristics (Inverter Output)

Table 12.5 Inverter Output (to Critical Load)

Item	Unit	Rated Power (kVA)
		1250 kVA 480 V
Rated AC voltage	VAC	480 3-wire (3-phase +PE)
Frequency	Hz	50/60
Power factor		0.99
Overload	%	<105%, long time <125%, ≤10 minute <150, ≤1 minute >150, ≤200 millisecond
Maximum short circuit current of inverter	A	180% rated output current, 200 millisecond
Steady state voltage stability	%	±1
Transient voltage response	%	±5
Total voltage harmonic distortion	%	<1 (linear load), <3 (non-linear load) <1 (linear load), <3 (non-linear load)
Synchronization window	Hz	Upper Limit: 0.5, 1, 2, 3, (+10%); Default: +10%. Lower Limit: -0.5, -1, -2, -3, (-10%); Default: -10%
Slew rate (maximum change rate of synchronization frequency)	Hz/s	0.6; setting range: 0.1 to 3

12.7 Electrical Characteristics (Bypass Input)

Table 12.6 Bypass Input

Item	Unit	Rated Power (kVA)
		1250 kVA 480 V
Rated AC voltage	VAC	480 3-wire (3-phase +PE)
Rated current	A	1504
Frequency	Hz	50/60
Bypass voltage tolerance	%VAC	Upper limit selections: +10%. Lower limit selections: -10%, -15%; default -10%.
Bypass frequency tolerance	%	±10
Bypass SCR I ² T	A ² S	6480000
Bypass KAIC fuse I ² T	kA ² S	2000 (pre arc). 13500 (clearing)
Bypass Withstand Rating		150 kAIC

12.8 Efficiency and Loss

Table 12.7 Efficiency and Loss

Item	Unit	Rated Power (kVA)
		1250 kVA 480 V
Rated normal mode (full load) loss	kW	46.2
Rated normal mode (no load) loss	kW	7.1
ECO mode (full load) loss	kW	12.5
Dual conversion mode efficiency	%	up to 97.5±0.2
ECO mode efficiency	%	up to 99

This page intentionally left blank

Appendices

Appendix A: Technical Support and Contacts

A.1 Technical Support/Service in the United States

Vertiv Group Corporation

24x7 dispatch of technicians for all products.

1-800-543-2378

Liebert® AC and DC Power Products

1-800-543-2378

A.2 Locations

United States

Vertiv Headquarters

505 N Cleveland Ave

Westerville, OH 43082

Europe

Via Leonardo Da Vinci 8 Zona Industriale Tognana

35028 Piove Di Sacco (PD) Italy

Asia

7/F, Dah Sing Financial Centre

3108 Gloucester Road, Wanchai

Hong Kong

Appendix B: Glossary

Term	Definition
AC	Alternating current
BCB	Battery circuit breaker
BFD	Backfeed disconnect
BIB	Bypass isolation breaker
CSA	Cross sectional area
DC	Direct current
DSP	Digital signal processor
ECO	Economy control operation
EIB	External interface board
EMC	Electromagnetic compatibility
EMI	Electromagnetic interference
EOD	End of discharge
EPO	Emergency power off
FPGA	Field programmable gate array
GFD	Ground fault detector
GND	Ground
GHMI	Global human machine interface
HMI	Human machine interface
I/O	Input/output
IGBT	Integrated gate bipolar transistor KAIC Kilo ampere interrupting capacity
KAIC	Kilo ampere interrupting capacity
LBS	Load bus synchronizer
LCD	Liquid crystal display
LED	Light-emitting diode
LLBB	Local Load Bank Breaker
LOTO	Lock out tag out
MBB	Maintenance bypass breaker
MCCB	Molded Case Circuit Breaker
MIB	Maintenance isolation breaker
MOB	Module Output Breaker
PC	Personal computer

Term	Definition
PE	Protective earth
RBB	Remote Bypass Breaker
RCCB	Residual current circuit breaker
RCD	Residual current detector
RIB	Rectifier input breaker
REPO	Remote emergency power off
SCR	Silicon-controlled rectifier
SLBB	System Load Bank Breaker
SNMP	Simple network monitoring protocol
SOR	Shunt Open Release
SSIB	Static Switch Isolation Breaker
STS	Static transfer switch
SVPWM	Space vector pulse width modulation
UPS	Uninterruptible power system
UVR	Under Voltage Relay
VRLA	Valve regulated lead-acid

Appendix C: Hazardous Substances and Content

Parts	Hazardous Substances					
	Plumbum	Mercury	Cadmium	Chrome ⁶⁺	Polybrominated Biphenyls	Polybrominated Diphenyl Ethers
	(Pb)	(Hg)	(Cd)	Cr (VI)	(PBB)	(PBDE)
Hex copper stud	x	○	○	○	○	○
PCBA	x	○	○	○	○	○
AC Capacitor	x	○	○	○	○	○
DC Capacitor	x	○	○	○	○	○
Fan	x	○	○	○	○	○
Cables	x	○	○	○	○	○
LCD	x	x	○	○	○	○
Sensors	x	○	○	○	○	○
Large-medium power magnetic components	x	○	○	○	○	○
Circuit breaker/rotating switch	x	○	○	○	○	○
Semiconductors	x	○	○	○	○	○
Battery (if applicable)	x	○	○	○	○	○
Insulation monitoring device (if applicable)	x	○	○	○	○	x
<p>NOTE: This table is prepared based on the regulation of SJ/T 11364.</p> <p>Content of the hazardous substances in all the average quality materials of the parts is within:</p> <p>○: The specified limits.</p> <p>x: Outsides specified the limits.</p> <p>About battery: Generally follow the environmental protection use period of the battery, otherwise five years.</p> <p>The Hazardous Substances and Content mentioned are applicable to Vertiv™ PowerUPS 9000 1250 kVA Modular UPS.</p>						

Connect with Vertiv on Social Media



<https://www.facebook.com/vertiv/>



<https://www.instagram.com/vertiv/>



<https://www.linkedin.com/company/vertiv/>



<https://www.x.com/Vertiv/>



Vertiv.com | Vertiv Headquarters, 505 N Cleveland Ave, Westerville, OH 43082 USA

©2025 Vertiv Group Corp. All rights reserved. Vertiv™ and the Vertiv logo are trademarks or registered trademarks of Vertiv Group Corp. All other names and logos referred to are trade names, trademarks or registered trademarks of their respective owners. While every precaution has been taken to ensure accuracy and completeness here, Vertiv Group Corp. assumes no responsibility, and disclaims all liability, for damages resulting from use of this information or for any errors or omissions.

SL-71927_REVA_01-25