



Vertiv™ PowerUPS 9000



Vertiv fact sheet

The world depends on data we power and cool.

Nearly all aspects of our lives involve the use of technology. It is how we work and play and do anything in between. This connectivity or use of data is built into the very fabric of our society. It is vital to human progress. Vertiv believes there is a better way to meet this accelerating demand for data — one driven by passion and innovation.

As industry experts, we collaborate with our customers to envision and build future-ready infrastructures. We leverage our portfolio of hardware, software, analytics, and services, to enable our customers' vital applications to run continuously, perform optimally, and scale with business needs.

Data centers: hyperscale/cloud, colocation, enterprise and edge

Communication networks: macro site, central office, small cell and data center

Commercial and industrial: healthcare, manufacturing, rail/mass transit, power generation and oil and gas

Geography¹

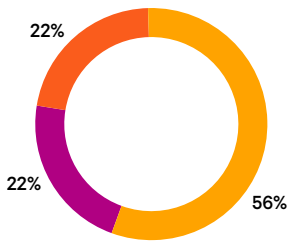

- Americas
- EMEA
- Asia Pacific

Broad range of power, thermal, and IT and edge infrastructure, solutions and services portfolio.

Portfolio¹

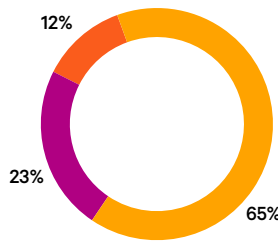

- Critical Infrastructure & Solutions
- Services & Spares
- Integrated Rack Solutions

Global, well-established footprint and supply-chain network.

Market Segment^{1, 2}

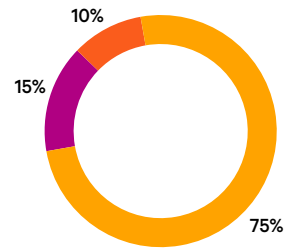

- Data Centers
- Communication Networks
- Commercial & Industrial

Customers who operate in some of the world's most critical industries.

Key facts

~\$6.9B
USD revenue

130+
countries served

#1 in thermal
management³

~27,000
employees globally

50+ years
in the industry

#1 in 3-phase large UPS
⁴and power switching & distribution⁵

Note: ¹ based on FY 2023 revenue; ² Market segment rounded to nearest 5%; ³ Dell'Oro Data Center Physical Infrastructure reporting 2023. ⁴ Omdia Uninterruptible Power Systems (UPS) Hardware Tracker 2023, >250kva; ⁵ Omdia Data Center Power Distribution Equipment Tracker 2023. All else, company information as of December 31, 2023.



Our purpose

We believe there is a better way to meet the world's accelerating demand for data — one driven by passion and innovation.

Our presence

Worldwide

Manuf. and Assembly Locations: **22**
 Service Centers: **240+**
 Service Field Engineers: **3,500+**
 Technical Support/Response: **190+**
 Customer Experience Centers/Labs: **19**

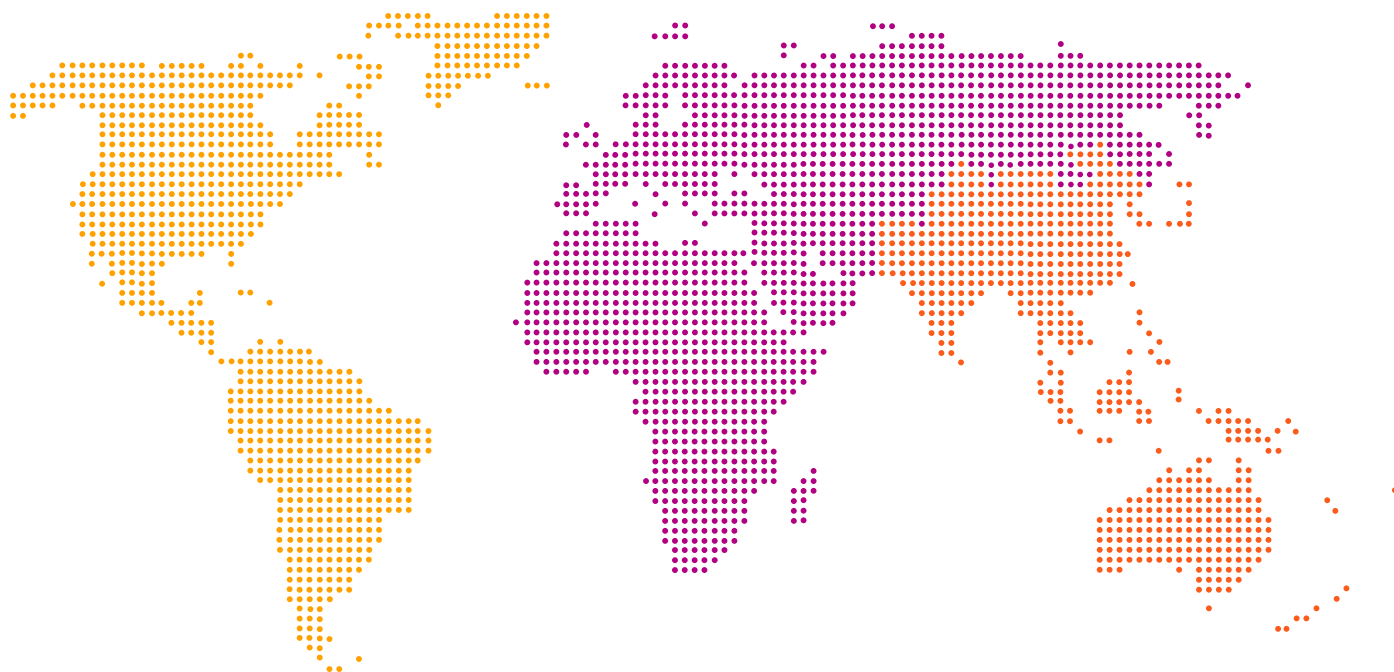

Americas

Manuf. and Assembly Locations: **8**
 Service Centers: **100+**
 Service Field Engineers: **1,600+**
 Technical Support/Response: **70+**
 Customer Experience Centers/Labs: **5**

Europe, Middle East, and Africa

Manuf. and Assembly Locations: **9**
 Service Centers: **60+**
 Service Field Engineers: **600+**
 Technical Support/Response: **100+**
 Customer Experience Centers/Labs: **5**

Asia Pacific

Manuf. and Assembly Locations: **5**
 Service Centers: **80+**
 Service Field Engineers: **1,300+**
 Technical Support/Response: **20+**
 Customer Experience Centers/Labs: **9**

Our brands

Albér™

Battery Monitoring

Avocent®

IT Management

Geist™

Rack PDU

NetSure™

DC Power

Liebert®

AC Power and Thermal

Energy Labs™

Commercial and Industrial Thermal

© 2024 Vertiv Group Corp. All rights reserved. Vertiv™ and the Vertiv logo are trademarks or registered trademarks of Vertiv Group Corp. While every precaution has been taken to ensure accuracy and completeness herein, Vertiv Group Corp. assumes no responsibility, and disclaims all liability, for damages resulting from use of this information or for any errors or omissions. Specifications are subject to change without notice.

Vertiv™ PowerUPS 9000 Overview and Benefits At a Glance

High performance, modularity, resilience, reliability and efficiency for your power needs.



Vertiv's most efficient UPS in its product class



Up to 32% space savings, compared to our offering



AI ready to support fast dynamic power loads



High-power solution designed for global standards and easy installation



Skid-mount and containerized power solutions for an easy deployment



Modular system for maximum flexibility from room to pre-fabricated deployment



Ready to integrate different back up power sources, including lithium-ion and nickel-zinc



Designed, tested and available **across the globe**



Hot and easy serviceability for no interruption, even during maintenance or power upgrades



Rich digital experience, Service empowered by data across entire lifecycle with Vertiv™ Life™ Advanced Incident Management and Condition Based Maintenance



Reliable, resilient and efficient UPS

Data centers face mounting pressures to secure unending uptime and reliability. Responding to these exigencies, Vertiv™ PowerUPS 9000 is designed to meet the contemporary resilience benchmarks. This is not just a response to market trends and needs but is deeply rooted in the lessons learnt and end user necessities, reflecting a commitment to address and integrate user feedback into tangible enhancements.

Design Reliability

- **Dedicated Segregated Controls for Each Power Module:**
This design choice enhances the system's overall reliability, allowing each power module to operate independently with its control logic.
- **Self-Isolating Power Module Through Relays:** In the event of a fault, affected power module can isolate themselves to prevent the spread of issues, ensuring the continuity of power supply from the remaining operational cores.
- **Continuous-Duty Solid State Static Bypass Switch:**
For the maximum performances on the bypass line.
- **Hot Service and Hot Swap Static Bypass and Power modules:**
Facilitates maintenance and upgrades without necessitating system downtime, directly contributing to enhanced operational availability and reducing the risk of unplanned outages.
- **Enhanced Diagnostic Tools (Waveform Capture, History Log):**
Enable preemptive identification and resolution of potential issues before they impact system performance, offering a deep insight into system health and preempting failures.

Each of these features is designed to satisfy the needs of customers for resilience and availability.

Verification & Validation Tests

For the verification and validation of Vertiv™ PowerUPS 9000 30 MW of Power Module prototypes have been built.

This approach enables the development of certain product features that enhance the operational integrity and also offer substantial benefits to customers.

Verification and Validation Tests are critical in securing that UPS systems adhere to stringent performance standards. Engineering Validation Tests (EVT) and Design Validation Tests (DVT) rigorously assessed and confirmed the product specifications.

Through this process, Vertiv™ PowerUPS 9000 has been validated against a spectrum of operational conditions to establish its capability to perform reliably in real-world scenarios. Additional tests have been performed to simulate critical conditions that a Vertiv™ PowerUPS 9000 might encounter. Some of the additional tests performed are:

- **Structural Tests** to verify seismic resilience and general durability
- **Debris Protection Testing** for environmental robustness
- **Voltage Surge & Sag Tests** to ascertain electrical resilience

Modular Design to Meet the Needs of Each Application

Vertiv™ PowerUPS 9000 scales the concept of modularity up to all levels of the UPS architecture.

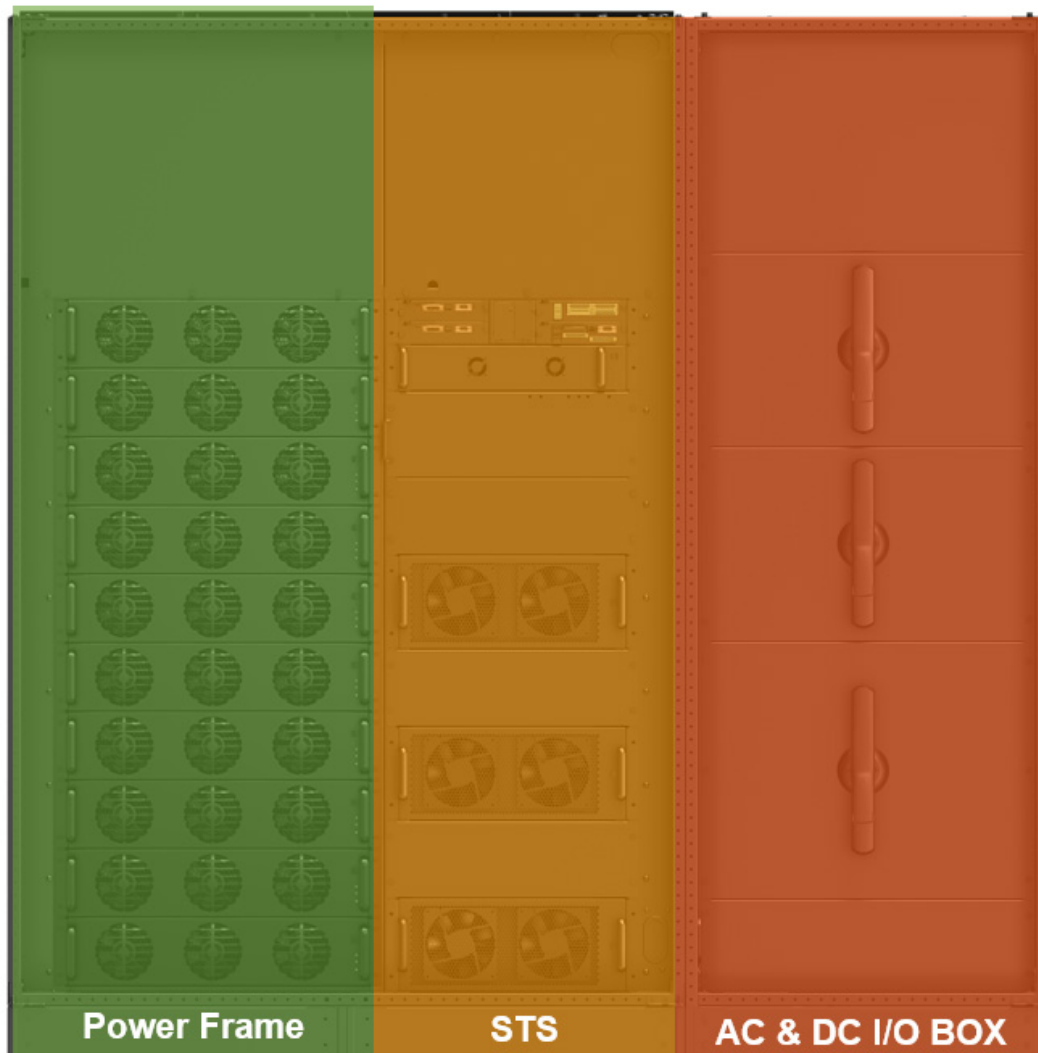

125kW Power Modules

Each Power Module is independent and includes the components of an online UPS: inverter, rectifier and booster/charger.

It features one global design with options for 400V and 480V, compliant with both CE and UL standards.

Static Switch Cabinet

The bypass static switch is housed in a dedicated cabinet, power terminals for close-coupled applications. It follows a global design for 400V and 480V.

AC I/O Cabinet

AC I/O Cabinet

AC power connections are routed through a dedicated cabinet:

Top and **bottom** power connection

Standard configuration includes cable connection, with optional flange connections available upon request

Capacity & Installation Flexibility from 250 KW up to 5 MW*

Vertiv™ PowerUPS 9000 features a **transformer-free design with full IGBT three-level double conversion technology**, providing extraordinary savings on installation and running costs, while at the same time delivering first class load protection.

Flexibility and Compatibility

Vertiv™ PowerUPS 9000 can be fully adapted to meet diverse system requirements in terms of power capacity and redundancy allowing for different system designs, thus ensuring maximum flexibility:

- Output Power Factor up to 1
- No power derating from 0.6 lagging to 0.7 leading
- Optimum space/power ratio

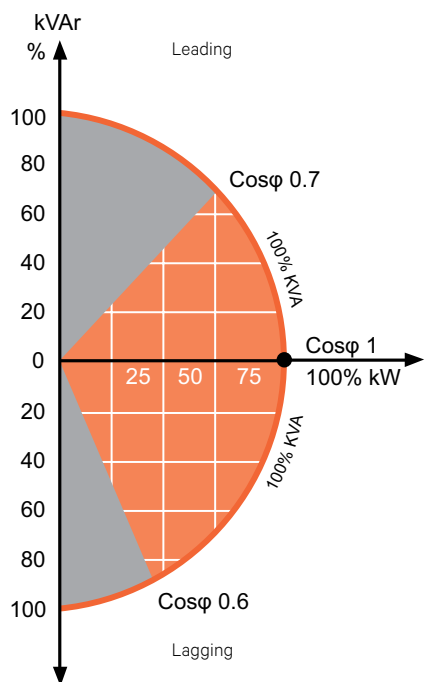

Figure 8: Power Factor Output Diagram

Maximized active power, high efficiency and complete compatibility for modern, mission critical IT loads.

Features and Performance

- Transformer-free design
- Full IGBT three-level topology
- Excellent input performances:
 - PF ≤ 0.99
 - THDi $\leq 3\%$
- Hybrid SiC Power Module Converters
- Seismic compliance
- Bypass sharing inductor-free design

Customer Monitoring Interfaces

LCD Touch Screen Features

- High security access with separate password levels for users and service engineers
- User-friendly graphical interface
- Single-line mimic diagram showing system status
- Dedicated warning/fault and event log page used to monitor UPS status and important events
- Dedicated measurements page for all UPS internal functional blocks

Hardware Connectivity

Vertiv™ PowerUPS 9000 allows for the monitoring and control of networked UPS, through different protocol options:

- The integration of UPS with Building Monitoring and Automation Systems via MODBUS RTU, MODBUS/TCP or JBUS protocols
- The integration of UPS in Network Management Systems through SNMP protocol
- Two slots for additional connectivity cards are available for specific protocol requirements

Software Connectivity

Vertiv connects and protects your network with core-to-edge solutions and remarkable expertise. For maximum visibility and effective monitoring in one view, pair your Vertiv™ UPS with a software solution.

Vertiv™ Environet™ Alert

Vertiv™ Environet™ Alert provides industry companies with critical facility monitoring software that is affordable and easy to use. This solution delivers superior monitoring, alerting, trending and data organization. Get monitoring, alerting and trending at a price that's right for your business.



*250kW minimum power capacity of a single 1250kW frame. Up to 5MW in parallel configuration.

Improved Efficiency

Vertiv™ PowerUPS 9000 delivers an outstanding **double conversion efficiency of up to 97.5%**, which further increases **up to 99% with the dynamic online mode**, consequently reducing operating costs and energy dissipation (kW) to a minimum. This significantly minimizes the consumption of the cooling system, providing an overall TCO reduction and rapid payback time.

Furthermore, through its intelligent **ECO mode** efficiency and the intelligent paralleling feature Vertiv PowerUPS 9000

can optimize efficiency even at partial load achieving additional superior cost savings.

Vertiv PowerUPS 9000 levels of efficiency and consequent electricity cost savings can be attributed to:

- Hybrid SiC power module design
- Adoption of a three-level topology for inverter
- DC controlled fan speed
- Intelligent paralleling mode
- Advanced digital technology and fast transfer

The seamless activation of Vertiv PowerUPS 9000 functioning modes ensures the highest level of efficiency without compromising power quality and availability.

The dynamic online mode ensures Class 1* output performance under most stringent conditions such as network faults (voltage variation, high/low impedance mains failures).

The unit is able to discriminate between various types of interferences and rapidly respond, while at the same time ensuring compatibility with downstream equipment such as servers, transformers, STS or mechanical loads.

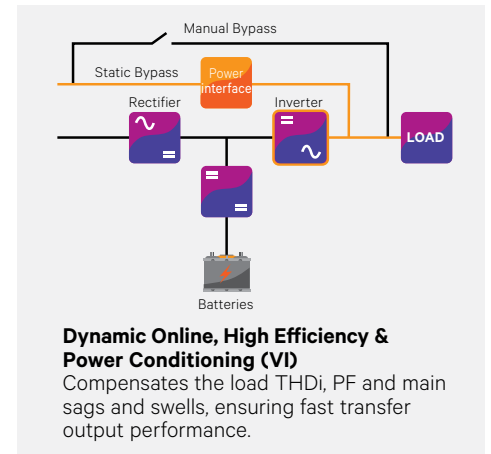
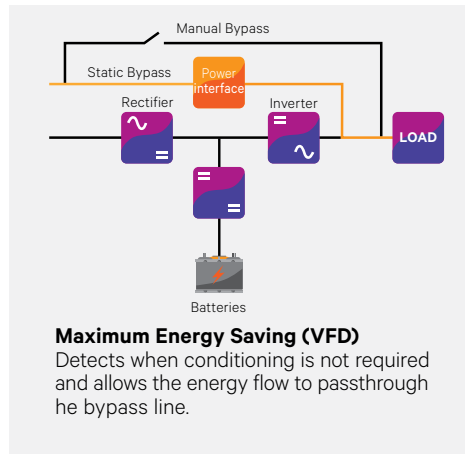
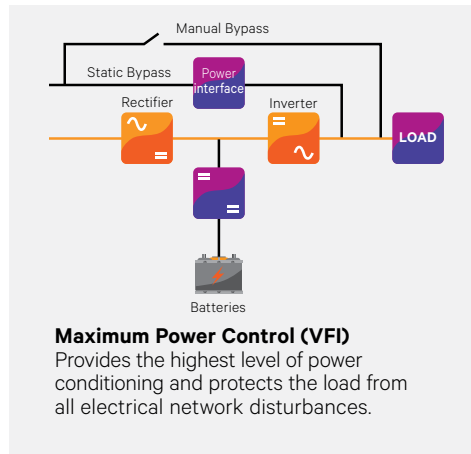

Dynamic Online mode: No more availability tradeoff with efficiency

Dynamic Online mode is developed for those that do not want to trade off any level of availability for incremental gains in efficiency. Dynamic Online mode enables **operating efficiency up to 99% without sacrificing availability**. While in this mode, the inverter can instantaneously assume the load and maintain the output voltage within the IEC 62040 Class 1* specification in most operating conditions, offering the same level of availability typically achieved in a double conversion operating mode.

Dynamic Online mode is therefore able to combine the **superior availability of a double conversion operating mode with the excellent energy cost savings of a high efficiency mode for a reduced total cost of ownership**.

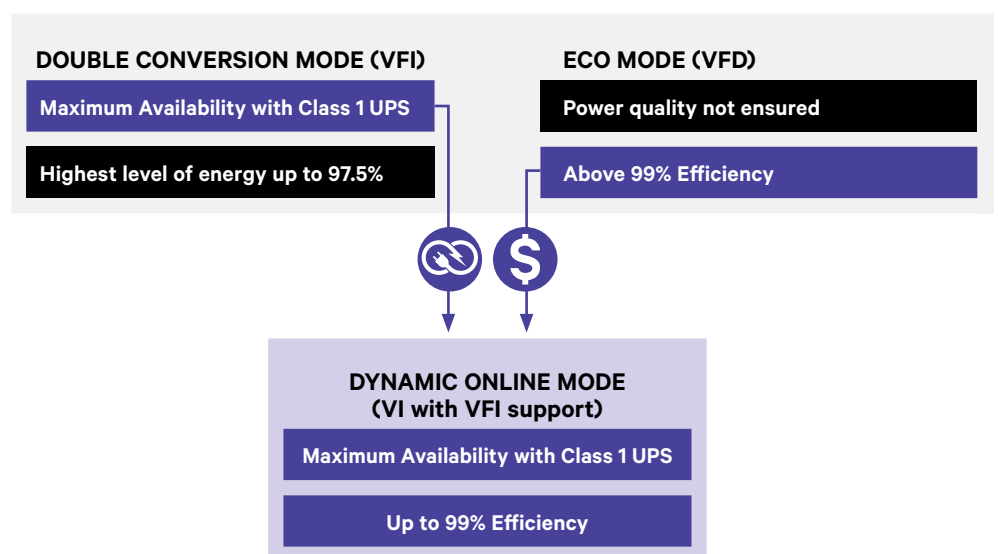

*Conditions apply

Continuous battery mode and continuous-duty static bypass switch

Vertiv™ PowerUPS 9000 Power Center stands out in the market for its **continuous battery mode**, a feature that secures uninterrupted power supply even at full load indefinitely.

Complementing its continuous battery mode is Vertiv PowerUPS 9000's solid-state static bypass switch, guaranteeing seamless power transitions. Vertiv PowerUPS 9000's continuous-duty performance opens doors to different applications beyond traditional UPS systems such as long duration batteries integration.

Reduced TCO

Neutral Carbon Footprint

Vertiv™ PowerUPS 9000's new generation architecture has been designed to reduce energy and heat dissipation, consequently minimizing the demand and consumption of air conditioning systems.

The combination of these factors, coupled with a double conversion efficiency of up to 97.5%, reduces CO₂ emissions to a minimum. This contributes to ensuring that your customers' data centers are a step closer to meeting the industry's environmental and efficiency compliance standards.



Advanced control diagnostic, excellent operating efficiency, intelligent paralleling feature, minimum footprint and high energy density make Vertiv PowerUPS 9000 the perfect UPS to deliver secure power to all mission critical applications, maximum energy saving and rapid return on investment.

Vertiv PowerUPS 9000 provides system capacity up to 1250kW in a single frame and up to 5MW in parallel configuration.

Furthermore, its **high power density** in a minimum space allows customers to maximize the number of racks and servers housed in their data center, thus granting more space for IT equipment.

The Vertiv PowerUPS 9000 technology, has brought extraordinary benefits in terms of:

- Compatibility with modern mission critical loads
- Enhanced performances for maximum energy saving
- CO₂ emission reduction
- System flexibility for all installations
- Reduced TCO

User Interface and Advanced Diagnostic

Vertiv™ PowerUPS 9000 makes your mission critical space a peaceful place through its advanced diagnostic capability, measuring and logging, enhanced event analysis as well as an intelligent colored multi-language touch screen display.

Vertiv PowerUPS 9000 advanced logic control platform together with the Vector Control technology enables increased performance of three-level power converters and real time control of output power quality, guaranteeing continuous operation and premium protection for your customer's business.

Bypass Input

Voltage and frequency measurements.

Mains Input

Current, voltage and frequency values of the three input phases.

Warning/fault

Alerts of anomalies on bypass, rectifier, inverter, booster/charger, battery and load.

Events log

Date and time of important UPS events, alarms and other warnings.

Measurements

Voltage, current and frequency values of each internal functional block.

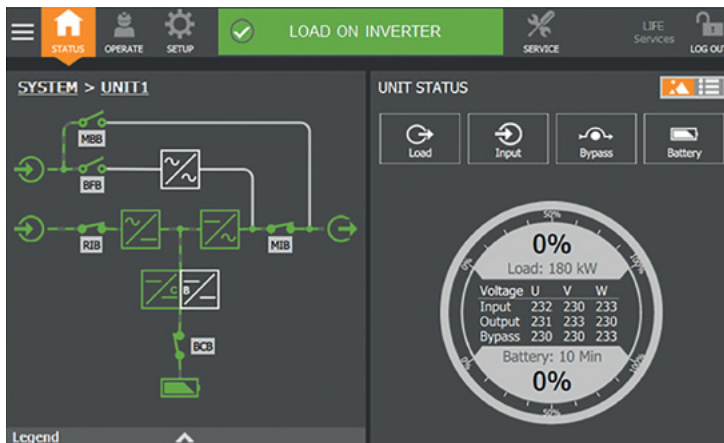

Waveform Capture: Enhancing Power Quality Analysis and System Reliability

Waveform Capture is a diagnostic tool that records the electrical waveforms of voltage and current. This capability is needed to understand and analyze power quality issues at critical moments (such as during power disturbances or faults) and to maintain the reliability of the power supply system.

The main advantages of Waveform Capture in Vertiv PowerUPS 9000 are:

- Precise Event Analysis:** By capturing the waveforms of both voltage and current during irregularities, the exact nature and cause of the disturbance can be understood. This includes recording events during and after an anomaly occurs.
- Preventive Maintenance:** Regular monitoring of the waveform data can help in predicting potential UPS problems before they lead to system failures, thereby supporting preventive maintenance efforts.
- Troubleshooting Support:** In the event of a failure, the stored waveform data provides valuable insight that can be used to troubleshoot issues, reducing the time required to restore normal operations.
- Historical Data Logging:** Capturing and storing waveform data over time allows for the analysis of trends and the detection of gradual changes in the power system that may indicate emerging problems.
- Customizable Data Capture:** Users can tailor the feature to their needs by selecting specific time frames and choosing the channels relevant to their power monitoring requirements.

This ensures that only pertinent data is captured and reviewed.

The Waveform Capture feature in the Vertiv PowerUPS 9000 enhances uptime and reliability through detailed electrical waveform analysis, offering a robust tool for maintaining critical infrastructure.

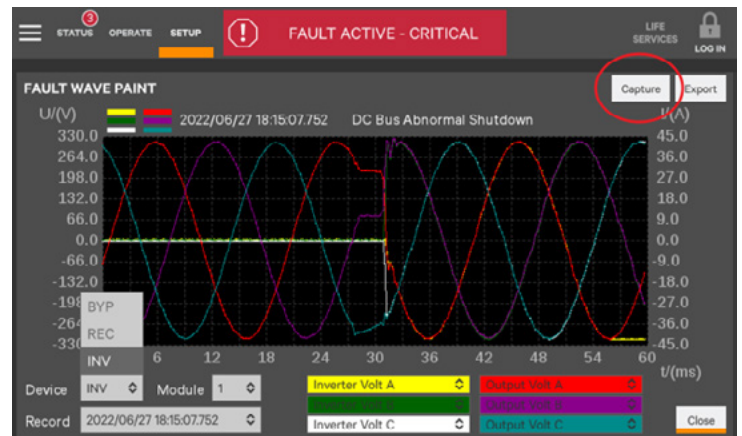

Rely on Integrated Project and Lifecycle UPS Services for Superior Critical Infrastructure Protection

Guarantee continuity to your business activities with a service partner who stands by you throughout your critical equipment lifecycle. From the project phase with start-up and testing, to lifecycle maintenance contracts and operational support, Vertiv secures your solution performs optimally.

Global Presence & Local Resources



With the broadest, most comprehensive service presence in the industry and more than **3,500** engineers dedicated to servicing the entire world, Vertiv secures that your business is always protected, and that service is available whenever needed 24 hours a day.

Project Services



From project planning and design, through to equipment procurement, installation, and commissioning, our project team offers comprehensive capabilities, ensuring speed of deployment and execution according to pre-defined and repeatable procedures.

Commissioning Phase	Technical Activities	Project Management
Pre-Project activity		<ul style="list-style-type: none"> Project Charter / Project Initiation Docs Identify Stakeholder
Level 0 Program and Design	<ul style="list-style-type: none"> Commissioning Spec & Plan Engineering Design Review Schedule Integration Submittal Review Commissioning Procedure Commissioning Kick-off 	<ul style="list-style-type: none"> Work Breakdown Structure (WBS) Supply Chain & Procurement Management Plan Project Team Creation Create Risk Management Plan Create Communication Management Plan Create Change Management Plan Create Project Schedule Health & Safety Assessment Kick-Off meeting with Customer
Level 1 Factory Witness Test	<ul style="list-style-type: none"> Factory Witness Test 	
Level 2 Delivery, QA/QC, Installation Assembly, Field Supervision	<ul style="list-style-type: none"> Site Acceptance Inspection Delivery & Assembly Equipment Installation 	<ul style="list-style-type: none"> Supply Chain & Procurement Management Execute Project Plan Schedule On-Site Resource Management Facilitate Team Meetings & Distributes Minutes Health & Safety Management
Level 3 Start-Up and Site Acceptance Test	<ul style="list-style-type: none"> Installation & Startup Pre-Functional Equipment Verification Site Acceptance Test 	
Level 4 Functional Performance Testing	<ul style="list-style-type: none"> Functional Performance Test 	
Level 5 Integrated System Test Support	<ul style="list-style-type: none"> Integrated System Test Training & O&M Verification 	
Level 6 Close Out & Turn-over	<ul style="list-style-type: none"> System Manual Seasonal Testing Warranty Review & Supplemental Report Commissioning Report 	<ul style="list-style-type: none"> Customer Acceptance Handover to Operation & Maintenance Lessons Learned Financial Closure Project Closure

- Manage Issues, Changes & Risks
- Report Project Status
- Contract, Financial & Quality Review
- Health & Safety Review

Expertise & Training



All service engineers are regularly certified according to country-specific regulations as well as wider international regulations and standards.

Vertiv service engineers are trained, experienced professionals who undergo an average of one week of intensive training each quarter, totalling one month of full-time training per year. Training includes both technology and safety, to secure competent and safe field operations, reinforced by established procedures to follow and central technical support in case of need.

Premium Response



With Vertiv you can count on an extensive supply of critical parts plus crash-kits ready for deployment, and on service engineers that can respond to requests in record time. To do so, they can rely on a solid knowledge-base, and established escalation procedures valid across the regions. In addition, they can also benefit from advanced incident management, and widespread presence of Service Centres all enabling them to deliver premium restoration capabilities.

Supporting Your Business Around the Globe



Regular service of critical equipment supports maximum uptime and reduces total cost of ownership. A service programme ensures timely and proactive maintenance for avoiding unexpected, costly equipment downtime and enables optimal equipment operation. Vertiv™ service programmes cover all technologies and can be tailored to suit individual business needs.



Vertiv deep infrastructure expertise is amplified by field data and analytics, enabling data-based services such as Advanced Incident Management and Condition Based Maintenance. These services complement our portfolio providing additional insight into operating trends allowing informed decision and minimising operational.

Vertiv's AI Load Management Solutions for Data Centers

Evolving Critical Power Needs

AI workloads are characterized by rapid power fluctuations that can be propagated along the entire powertrain and create problems for the equipment installed. Relying on PowerUPS 9000 **overload capabilities, for a limited period of time, is one way** to support such load swings, as the UPS is designed to support load increases beyond the rated power without affecting the performance.

AI power loads are also changing the pattern of the electrical demand in AI data centers from a constant pattern to a very variable pattern.

Vertiv™ PowerUPS 9000 is the right choice for AI applications where the user wants to avoid hitting the battery to prevent accelerating its aging due to small but frequent discharge/recharge cycles.

In addition the UPS could handle rapid fluctuations and high slew rates in input current and maintain stability in output currents and voltages.

Impact of AI applications on critical infrastructure

With the forecast growth in rack densities for AI and high-performance computing (HPC) applications, Vertiv is developing solutions designed to withstand higher voltages, manage fast variable AI loads and provide power protection for liquid cooling systems.

Vertiv addresses these evolving needs with resilient and flexible solutions designed to minimize the impact of single-point failures and support distributed power protection

Vertiv™ PowerUPS 9000	
Overload Capabilities at 25°C	<ul style="list-style-type: none"> <105% continuous <125% for 10 min <150% for 1 min
Overload Capabilities at 40°C	<ul style="list-style-type: none"> <105% continuous <125% for 10 min <150% for 1 min

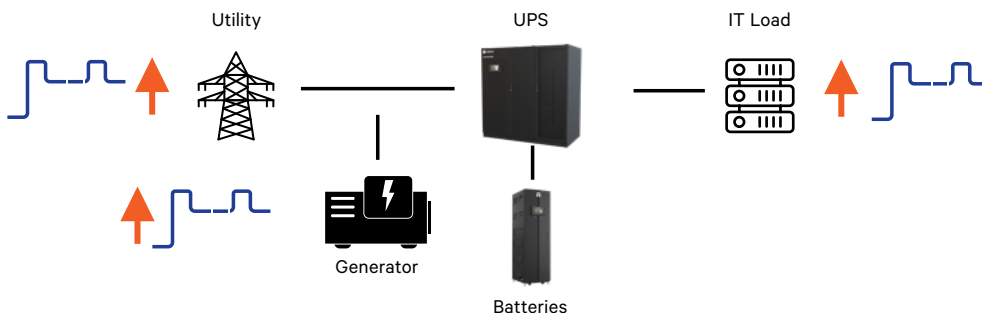

Long-term planning data center

Vertiv's approach focuses on modular, scalable, and sustainable solutions to meet the growing demands of AI and high-density computing. By integrating advanced power management algorithms and supporting new energy sources, Vertiv secures data centers can handle the dynamic and intensive workloads of the future.

For more detailed information on Vertiv's innovative solutions, visit our [AI Hub](#).

Enhance Your Power Reliability with Distributed Battery Systems in a parallel configuration

Uninterrupted power supply is essential for maintaining the seamless operation of critical applications, especially in large-scale data centers. At Vertiv, we understand the pivotal role that a resilient UPS system plays in protecting your electronic equipment from power disruptions, blackouts, and voltage spikes. When Vertiv PowerUPS 9000 systems are in parallel configuration, our advanced distributed battery systems are designed to enhance the reliability and efficiency of your UPS systems, securing continuous power quality and availability.

Why Choose Distributed Battery Systems?

1. Unmatched High Tolerance:

Distributed battery systems decentralize battery modules, allowing for effective fault isolation and management. This design ensures that even if one module encounters an issue, the remaining modules continue to provide uninterrupted power, significantly reducing the risk of complete system failures.

2. Scalability and Flexibility:

Our distributed systems are easily scalable, enabling you to add more modules as your power needs grow. This flexibility provides a cost-effective path for scaling your power infrastructure, making it adaptable to evolving requirements.

3. Maintenance Efficiency:

With distributed battery systems, maintenance can be performed on individual modules without disrupting the overall system. This approach minimizes downtime and ensures that your critical operations remain uninterrupted.

4. Enhanced System Availability:

Distributed battery systems guarantee continuous power supply, which is crucial for mission-critical applications. By reducing the likelihood of complete system outages, our systems enhance overall availability and reliability, ensuring your operations are always protected.

Tailored for Mission-Critical Environments: At Vertiv, we design our solutions with your most critical power scenarios in mind. Our distributed battery systems integrate seamlessly with modular UPS designs, offering the highest levels of fault tolerance and maintenance efficiency. Secure your power infrastructure is as resilient as your business demands with Vertiv's distributed battery systems.

Vertiv™ EnergyCore Battery Cabinet

The Vertiv™ EnergyCore is the first optimized battery cabinet designed by datacenter experts for data center users. The Vertiv EnergyCore system has successfully completed a UL 9540A fire test. According to NFPA 855's ESS installation standards, when successfully completing a UL9540A test, three feet (92cm) spacing requirements between racks can be waived by the Authorities Having Jurisdiction (AHJ).

The Vertiv EnergyCore is engineered to provide safe, reliable, and cost effective energy that improves critical infrastructure performance over traditional valve-regulated lead-acid systems.

Not only do users enjoy the longer life, more cycles and fewer replacements of this system, they also benefit from its compact, smaller size and lower weight. These advantages directly impact an impressive total cost of ownership experience.



Vertiv™ EnergyCore Battery Cabinet

Reduce Battery Replacement Cycles



VRLA = valve regulated lead-acid
LIB = data center lithium-ion

Fewer Facility Disruptions
Lower Total Cost of Ownership

Overview

Lithium-ion battery, as one of the most influential technical breakthroughs in the last decade, has transformed our lifestyle and reshapes the world by powering from our cell phones and notepads to our new e-cars and renewable power plants. It will be the next generation batteries to power our UPS and datacenters.

Vertiv's innovative mindset and early experience with lithium-ion batteries has helped many organizations achieve their infrastructure goals.

Ideally Suited For

- New data centers
- Cloud, colo, hosting facilities
- Enterprise data centers
- UPS energy storage
- Replacements to lead-acid batteries

Compliant

- UL 1973
- UL 9540A Tested
- UL 9540

Qualified for immediate use with most current and legacy three phase Vertiv™ Liebert® UPS systems.

READY FOR



Technical Data Vertiv™ PowerUPS 9000

1250kW 380V/400V/415V

Primary Input

Nominal mains input voltage / voltage range	(V)	380V/400V/415V (305-478), 3Ph+N+PE
Nominal frequency / frequency tolerance	(Hz)	Selectable 50 or 60
Input Power Factor (above 50% of load)		≥ 0.99
Input current distortion (At full linear load Calculated at input THDv <2%)	(%)	≤3
Walk in/soft start	(seconds)	2 (0.5 to 5 selectable)
Rectifier Hold-Off	(seconds)	4 (1 to 120 selectable)

Inverter Output

Nominal apparent power	(kVA)	1250
Nominal active power	(kW)	1250
Nominal output current @ nominal voltage 400/480V	(A)	1815
Maximum output active power @ 40°C	(kW)	1250
Inverter Overload Capacity ⁽⁵⁾		<105% Continuous 105%-125% :10min 125%-150%: 1min 150%-200%: 200ms
Nominal output voltage	(V)	400 (380 to 415 selectable), 3Ph+N+PE
Nominal output frequency	(Hz)	Selectable 50 or 60
Output load Power Factor without derating		0,7 leading - 0,6 lagging
Voltage stability in steady state condition for input (AC & DC) variations and step load (0 to Nominal load)	(%)	±1
Voltage stability in dynamic condition for input variation (AC & DC) and step load	(%)	Complies with IEC/EN 62040-3, Class 1
Voltage stability in steady state for 100% load unbalance (0, 0, 100)	(%)	±3
Frequency slew rate	(Hz/sec)	0.6 default (selectable up to 3Hz for single system, 2Hz for parallel system)
Output voltage distortion at nominal linear load	(%)	<1
Output voltage distortion @ reference non linear load as for IEC/EN 62040-3	(%)	≤3
Phase angle precision with balanced loads	(degrees)	±1
Phase angle precision with 100% unbalanced loads	(degrees)	±1.5

DC Source

Battery types		VRLA, Li-Ion, Ni-Zn
Permissible battery voltage range	(V)	384 to 681
Recommended n° of VRLA cells:		240-300
Float voltage for VRLA @ 20 °C	(V/cell)	2.27
End cell voltage for VRLA	(V/cell)	1.6
Float voltage stability in steady state condition	(%)	≤1

Optimum battery temperature	(°C)	15 to 25
Battery recharge current setting range for 240cells @ 400V input voltage & maximum output load (PF=1) ⁽⁶⁾	(A)	550
Static Bypass		
Nominal bypass input voltage	(V)	400 (380 to 415 selectable), 3Ph+N+PE
Nominal bypass input voltage range	(%)	+15% -20% (+10% to +20%, -10% to -40% selectable)
Nominal output frequency	(Hz)	Selectable 50 or 60
Frequency range	(%)	±10%
Maximum static bypass overload capacity ⁽⁵⁾ :		
For 10 minutes	(%)	110% to 130%
For 1 minute	(%)	130% to 160%
General System Data		
AC/AC efficiency VFI without charging current @ nominal input conditions ⁽³⁾⁽⁴⁾ with resistive load ⁽⁶⁾ :		Up to 97.5%
AC/AC efficiency with dynamic online (VI) without charging current @ nominal input conditions ⁽³⁾⁽⁴⁾ with maximum resistive load:		Up to 99%
AC/AC efficiency in Intelligent ECO mode without charging current @ nominal input conditions ⁽³⁾⁽⁴⁾ with maximum resistive load:		Up to 99%
Prospective short circuit current Icp with bypass fuses	(kAIC)	Up to 150
Heat dissipation @ nominal input conditions and nominal output load ⁽⁷⁾ :		
Float Mode VFI	(BTU/h)	123690,15
	(kW)	36,25
Float Mode VFD	(BTU/h)	36254,01
	(kW)	10,625
Mechanical dimensions:		
Height	(mm)	2000mm
Width	(mm)	2000mm
Depth	(mm)	1000mm
Net Weight	(kg)	2010kg
Noise @ 1 meter ⁽³⁾⁽⁴⁾ as per ISO 7779/3746 at full load	(dBA ± 2dBA)	79
Protection degree with open doors		IP20
Fame colour (RAL scale)		7021
Cable entry		Top/Bottom
Service Access		Front and Top
Access		Front and Top (no rear access required)
Cooling		Forced Ventilation, front air intake, top air outlet

Environmental

Location		Indoor (free from corrosive gases and conductive dust)
Operating Temperature	(°C)	0 to 50 with automatic derating from 40°C
Maximum relative humidity @ 20 °C (non condensing)	(%)	Up to 95% with humidity control and correction
Max altitude above sea level without derating	(m)	1500 (for higher altitudes complies with IEC/EN 62040-3)
Immunity to electrical interference		IEC / EN / BS 62040-2
EMC Class		IEN / EN 62040-2 Class C3
Environmental Aspects		IEC/ EN/ 62040-4
Classification according to IEC/EN 62040-3		VFI-SS-111
IEC Technical Report 61641 (Class A)		Guidelines for testing low-voltage switchgear and control gear assemblies under internal arcing faults.
Options		Integrated Backfeed Protection Device
		DC Ground Fault Detection
		EPO Push Button
		Flange connections (late customization)
		Vertiv™ Life™ Services Remote Diagnostic and Preventive Monitoring
Network Protocols with Monitoring Card		Battery Trip Option
		Modbus TCP
		BACnet/WS
		BACnet/IP
		SNMP v.1, v.3, IPv6

Note:

(1) Short circuit values depend on UPS rating, please contact Vertiv Technical Support for more information

(2) Values specified for single unit. Units in parallel may have different values due to contribution of the parallel connections. Please contact Vertiv Technical Support for more information

(3) For tolerance see IEC/EN 60146-1-1 or DIN VDE 0558. The data refer to 25°C ambient temperature

(4) At nominal voltage, nominal frequency





(5) Value obtained at 25°C

(6) Value obtained at 50% of load, input THDi <1%, 415Vac



(7) Values obtained at 415Vac

Global presence for a close partnership. Everywhere.

Global AC Power Sites

-  **4** Laboratories and R&D
-  **5** Manufacturing Sites
-  **3** Witness Test Sites
-  **9** Main Training Centers
-  Global Network of Regional Sales and Service Representatives

AC Power Highlights

-  **100K+**
Square meter of manufacturing space
-  **Up to 12MW**
Available for witness tests
-  **92k**
Hours of technical training each year



Main Witness Test and Customer Experience Center sites.

Vertiv™ state-of-the-art Customer Experience Centers enable our customers to experience first-hand a wide variety of data center technologies, including **demo, standard, customized and remote virtual FAT experiences**, supported by constant consultation from R&D and engineering specialists.

Bologna, Italy - Customer Experience Center

- **800+** Customers every year
- From **50+** countries
- **10+** people dedicated
- **1700 m²** Witness Testing
- **650 m²** Showroom
- **650 m²** Academy
- **5** testing stations, each providing up to 3.5 MVA of capacity = total 4 MW
- **140+** witness test every year
- **400+** UPS systems tested each year
- **Up to 4000 A** simultaneous test at full load



Delaware, US - Power Test Center

- **4,000+** m², including **280+** m² customer observation suite
- **40** testing bays, each containing multiple distinct test stations - total 12 MW available
- **100+** tour-factory witness test each year



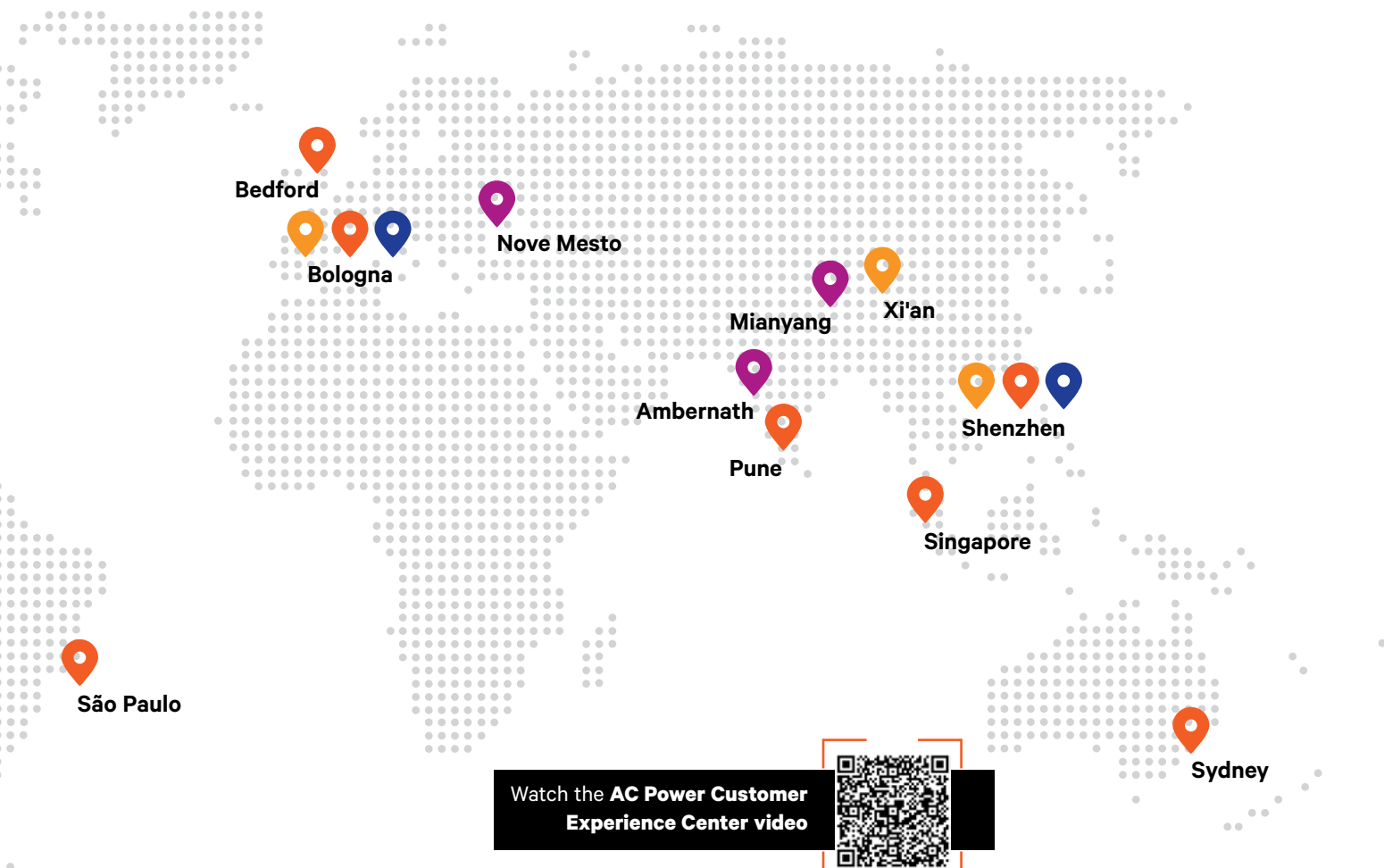

Watch the **AC Power Customer Experience Center** video

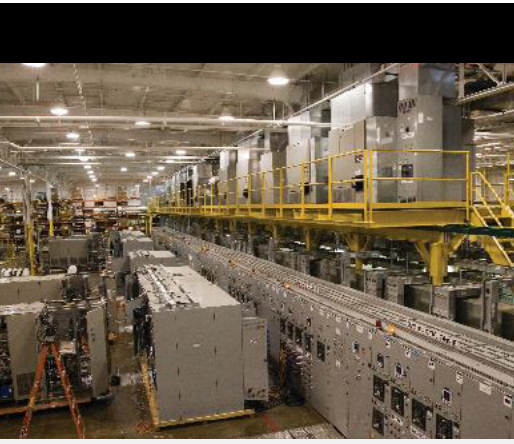

Mianyang, China - Power Test Center

- **100+** Customers every year
- From **25+** countries
- **2** people dedicated
- **180 m²** Witness Testing
- **60 m²** Showroom
- **2** testing stations, each providing up to 1.2 MVA of capacity = total 2.5 MW
- **40+** witness test every year
- **100+** UPS systems tested each year
- **Up to 1.8 A** simultaneous test at full load





Vertiv.com

© 2025 Vertiv Group Corp. All rights reserved. Vertiv™ and the Vertiv logo are trademarks or registered trademarks of Vertiv Group Corp. All other names and logos referred to are trade names, trademarks or registered trademarks of their respective owners. While every precaution has been taken to ensure accuracy and completeness herein, Vertiv Group Corp. assumes no responsibility, and disclaims all liability, for damages resulting from use of this information or for any errors or omissions. Specifications are subject to change without notice.