



# Vertiv™ MPH2™ Rack PDU

Installer/User Guide

### **Technical Support Site**

If you encounter any installation or operational issues with your product, check the pertinent section of this manual to see if the issue can be resolved by following outlined procedures. Visit <https://www.VertivCo.com/en-us/support/> for additional assistance.

# TABLE OF CONTENTS

---

<b>1 Important Safety Instructions</b> .....	<b>1</b>
1.1 Installation Recommendations .....	2
1.2 Safety Symbols .....	4
<b>2 Introduction</b> .....	<b>5</b>
2.1 Metering Levels .....	5
2.2 Mounting .....	5
2.3 Locking Receptacles - IEC Type Only .....	5
2.4 Overcurrent Protection .....	5
2.5 Integrated Monitoring and Management .....	5
2.6 General Characteristics .....	7
2.7 Model Types .....	8
2.8 Appearance and Components .....	8
2.8.1 RPC2™ module controls and indicators .....	8
2.8.2 LED indicators .....	8
2.8.3 On-board LCD controls and indicators .....	9
2.8.4 Power components .....	9
2.8.5 Branch overcurrent protection .....	10
2.8.6 Hard-wired connection features .....	11
<b>3 Installation</b> .....	<b>13</b>
3.1 Attaching Input Power Cords—Hard-wired Models Only .....	13
3.1.1 Attaching Input-power Cords without Conduit .....	13
3.1.2 Attaching Input-power Cords with Conduit .....	14
3.2 Tool-less Mounting .....	16
3.3 Installing a MPH2™ Rack PDU in a Vertiv™® Rack .....	16
3.3.1 Mounting Hardware and Tools Required .....	16
3.3.2 Mounting the Vertical MPH2™ Rack PDU .....	17
3.3.3 Mounting the Horizontal MPH2™ Rack PDU .....	17
3.3.4 Mounting a Horizontal MPH2™ Rack PDU on Vertical Frame Member with Aluminum Extrusions .....	18
3.3.5 Rack Grounding strap .....	19
3.3.6 Recommended Input Branch Circuit Protection .....	20
3.4 Connecting Rack Equipment .....	21
3.5 Installing Optional Items .....	22
3.5.1 RPC Basic Display Module Installation .....	22
3.5.2 Temperature/Humidity Sensor Installation .....	24
<b>4 Operation</b> .....	<b>25</b>
4.1 Controls and Indicators .....	25
4.2 View Input-level Information .....	26
4.2.1 Communication Link with RPC2 .....	26
4.3 View MPH2™ Rack PDU System Information .....	27

---

4.3.1 System and Screen Options .....	27
4.3.2 Rebooting .....	28
4.3.3 Restore System Defaults .....	29
4.3.4 Determine IP Address, MAC Address and Firmware Version .....	31
4.3.5 Adjust the Contrast of the On-board LCD .....	31
4.3.6 Adjust the Orientation of the On-board display .....	32
4.4 View Active Alarms .....	32
4.4.1 Silence an Audible Alarm .....	32
4.5 View Branch-level Information .....	33
4.6 View Receptacle-level Information .....	33
4.7 View Sensor Information .....	35
4.8 Opening and Closing Circuit Breakers .....	36
<b>Appendices .....</b>	<b>39</b>
Appendix A: Specifications .....	39
Appendix B: Troubleshooting .....	41
Appendix C: Additional Troubleshooting by Plug Type .....	43

# 1 IMPORTANT SAFETY INSTRUCTIONS

## SAVE THESE INSTRUCTIONS

This safety sheet contains important safety instructions. Read all safety, installation and operating instructions before installing the Vertiv™ MPH2™ Rack Power Distribution Unit (PDU). Adhere to all warnings on the unit and in this safety sheet. Follow all instructions.

- The MPH2™ Rack PDU is designed for information technology equipment. The MPH2™ Rack PDU is not intended for use with life support or other designated critical devices. If uncertain about its intended application, consult your local dealer or Vertiv™ representative.
- Maximum load must not exceed the rating shown on the MPH2™ Rack PDU nameplate.
- The rated line voltage must not exceed 240 VAC for connection to AC power distribution systems with an isolated or high-impedance ground.
- Operate the MPH2™ Rack PDU in an indoor environment only in the appropriate ambient temperature range, as follows:
  - 32°F to 140°F (0°C to 60°C) for 32A or less input models.
  - 32°F to 122°F (0°C to 50°C) for 40A and 48A input models without case ventilation.
  - 32°F to 140°F (0°C to 60°C) for 40A and 48A input models with case ventilation.
- Install the MPH2™ Rack PDU in a clean environment, free of conductive contaminants, moisture, flammable liquids, combustible gases and corrosive substances.
- The MPH2™ Rack PDU must be installed in a restricted-access location. A restricted-access location is an area where access is possible only through the use of a tool or lock and key or other means of security, and is controlled by the authority responsible for the location.
- The MPH2™ Rack PDU has no user-serviceable parts. Under no circumstances attempt to gain internal access due to the risk of electric shock or burn.
- Refer any unexpected behavior or unusual fault conditions to your local dealer, Vertiv™ representative or Vertiv™ Applications Engineering.
- Vertiv recommends powering only safety agency approved devices from the MPH2 Rack PDU.
- For permanently connected rack PDUs (hard-wired versions), a readily accessible disconnect device must be incorporated externally to the equipment.
- For rack PDUs with attached input power-supply cords, the socket must be installed near the equipment and must be easily accessible.

 **WARNING!** Opening or removing end caps from an MPH2™ Rack PDU may expose personnel to lethal voltages within the rack PDU. Observe all cautions and warnings. Failure to do so may result in serious injury or death. MPH2™ Rack PDU units contain no user-serviceable parts. For service or technical support, contact Vertiv™ Applications Engineering or your local Vertiv™ representative. Do not attempt to service this product yourself.

 **CAUTION:** Connecting an MPH2™ Rack PDU to a power supply with an incorrect rating in voltage or amperes may damage the connected equipment and your MPH2™ Rack PDU. For questions about the power supply connections, contact Vertiv™ Applications Engineering or your local Vertiv™ representative.

 **CAUTION:** Ensure that the ratings of each connected device do not exceed the specified rating at each branch and receptacle.

 **CAUTION:** All configuration steps must be completed before attempting to start equipment connected to the MPH2™ Rack PDU.

 **CAUTION:** For power management purposes, record the receptacle where each piece of equipment is connected. Receptacles on the MPH2™ Rack PDU have a numeric designation. The MPH2™ Rack PDU identifies the receptacles with numbers that are grouped by branch with a letter referring to the corresponding circuit breaker.

## 1.1 Installation Recommendations

- Elevated Operating Ambient Temperature - If installed in a closed or multi-unit rack assembly, the operating ambient temperature of the rack environment may be greater than room ambient temperature. Therefore, consideration should be given to installing the equipment in an environment compatible with the maximum ambient temperature (T<sub>ma</sub>) specified by the manufacturer.
- Reduced Air Flow - Installation of the equipment in a rack should be such that the amount of air flow required for safe operation of the equipment is not compromised.
- Mechanical Loading - Mounting of the equipment in the rack should be such that a hazardous condition is not created due to uneven mechanical loading.

### EUROPEAN UNION

#### **Notice to European Union Customers: Disposal of Old Appliances**

This product uses components that are dangerous for the environment, such as electronic cards and other electronic components. Any component that is removed must be taken to specialized collection and disposal centers. If this unit must be dismantled, this must be done by a specialized center for collection and disposal of electric and electronic appliances or other dangerous substances. This product has been supplied from an environmentally aware manufacturer that complies with the Waste Electrical and Electronic Equipment (WEEE) Directive 2012/19/EU. The “crossed-out wheeie bin” symbol is placed on

this product to encourage you to recycle wherever possible.

Please be environmentally responsible and recycle this product through your recycling facility at its end of life. Do not dispose of this product as unsorted municipal waste. Follow local municipal waste ordinances for proper disposal provisions to reduce the environmental impact of waste electrical and electronic equipment (WEEE).

For information regarding the disposal of this equipment, go to <http://www.VertivCo.eu>.

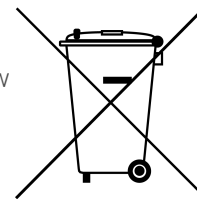

#### ROHS Compliance

The MPH2™ Rack PDU modules comply with the Restriction of Hazardous Substances directive (ROHS), prohibiting use of six hazardous materials manufacturing of electronics, including lead-free solder.

#### FCC Compliance

This unit complies with the limits for a Class A device pursuant to Part 15 of the FCC Rules. Operation is subject to the following two conditions:







This device may not cause harmful interference.

This device must accept any interference received, including interference that may cause undesired operation.

**NOTE: This equipment has been tested and found to comply with the limits for a Class A digital device, pursuant to Part 15, Subpart B of the FCC Rules. These limits are designed to provide reasonable protection against harmful interference when the equipment is operated in a commercial environment. This equipment generates, uses and can radiate radio frequency energy and, if not installed and used in accordance with the instruction manual, may cause harmful interference to radio communications. Operation of this equipment in a residential area is likely to cause harmful interference, in which case the user will be required to correct the interference at his own expense.**

## 1.2 Safety Symbols

The following symbols may appear within the documentation or on the product.

SYMBOL	MEANING
	<p><b>High Temperature</b></p> <p>Alerts the user where the enclosure temperature may exceed 158°F (70°C) while operating under high-ambient temperature and at maximally rated load.</p>
	<p><b>Instructions</b></p> <p>Signifies the presence of important operating and maintenance (servicing) instructions in the literature accompanying the appliance.</p>
	<p><b>Dangerous Voltage</b></p> <p>Warns about the presence of uninsulated dangerous voltage within the product's enclosure that may be of sufficient magnitude to constitute a risk of electric shock to persons.</p>
	<p><b>Power On</b></p> <p>Indicates the principal On/Off switch is in the On position.</p>
	<p><b>Power Off</b></p> <p>Indicates the principal On/Off switch is in the Off position.</p>
	<p><b>Protective Grounding Terminal</b></p> <p>Indicates a terminal that must be connected to earth ground before any other connections to the equipment may be made.</p>



## 2 INTRODUCTION

The Vertiv™ MPH2™ Rack PDU is an intelligent, high-availability line of managed rack PDUs. It offers remote monitoring and control capabilities as well as environmental sensors with multiple power input selections and output configurations.

### 2.1 Metering Levels

Four types of rack PDUs are available that provide metering and status of important electrical parameters for input, branch and receptacle levels, as well as integration with environmental sensors. The available information varies by type of rack PDU. See [Model Types](#) on page 8 for descriptions.

### 2.2 Mounting

Rack PDUs are available for mounting in vertical and horizontal configurations in standard racks or network enclosures.

Because the power cord is connected at the end of the vertical-mount (O-U) models, the rack PDUs may be oriented to accommodate top or bottom cable-entry into the rack.

### 2.3 Locking Receptacles - IEC Type Only

Locking receptacles are available on models with IEC receptacles. The locking feature requires optional locking power cords to be installed on devices powered by the .rack PDU.

The receptacles require no modification to function properly with non-locking power cords.

### 2.4 Overcurrent Protection

All rack PDU units with an input current rating greater than 20A feature 100% rated hydraulic-magnetic breakers. For all UL-listed models, the maximum cord and plug-connected loading is limited to 80% of the input current rating, as required by UL and in accordance with the National Electric Code.

Low-profile circuit breakers are used on all OU rack PDUs with two or three branch circuits. Standard-profile circuit breakers are used on horizontal models and on certain vertical models that have six branch circuits or have a 240 VAC rating. Each type of circuit breaker is a flush-mount, rocker style (see [Manually Changing a Circuit Breaker State](#) on page 36).

### 2.5 Integrated Monitoring and Management

The factory-installed Vertiv™ RPC2™ communications module permits managing the Vertiv™ MPH2™ Rack PDU over a secure web page and SNMP (Simple Network Management Protocol) based network management system. The RPC2 module permits interconnecting up to four rack PDUs in a Rack PDU Array™ configuration for monitoring and management.

**NOTE: Do not interconnect RPC-1000 modules with RPC2 modules in an array. They are incompatible and will not interoperate.**

**NOTE: Refer to the RPC2 Communications Module Installation/User Guide, SL-20841, for detailed instructions on installing and using the RPC2 communication module. The document is available at: <http://www.VertivCo.com>.**

A rack PDU can be monitored locally through its on-board LCD, through a Web interface or through an optional display module, the RPC BDM (Part# RPCBDM-1000). The display module connects directly to

the RPC2 communications module and may be moved between operating rack PDUs. It can be hand-held, mounted in or on the rack or mounted on a wall near the rack PDU it is monitoring.

Multiple rack PDUs can be managed with these software applications:

- Avocent™ Rack Power Manager software
- Avocent DSView™ management software
- Vertiv™ Trellis™ Real-Time Infrastructure Optimization platform software
- Liebert® Nform® software, which adds group-based receptacle management
- Liebert® SiteScan® software
- Vertiv™ MCT, Mass Configuration and Firmware Update software

**Figure 2.1 Vertical Rack PDU Configuration**

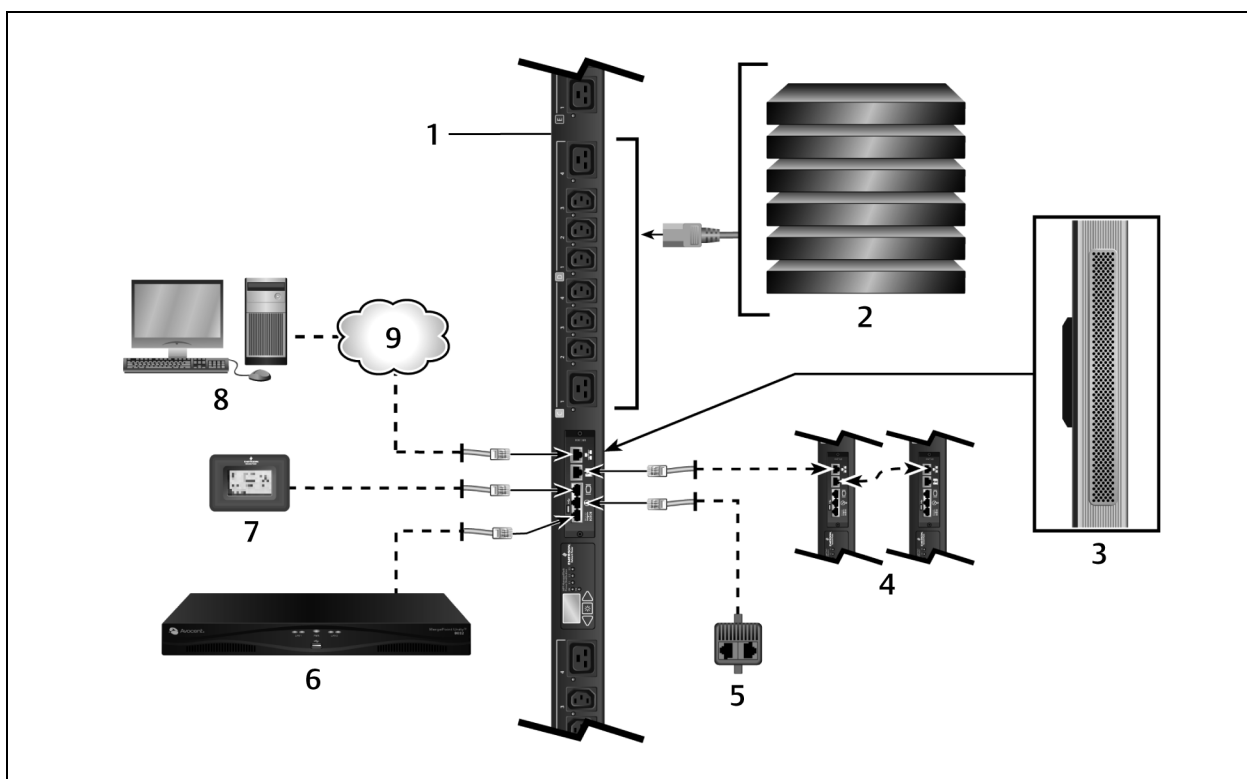

**Table 2.1 Vertical rack PDU Configuration Descriptions**

ITEM	DESCRIPTION	ITEM	DESCRIPTION
1	Vertical rack PDU	6	Serial appliance
2	Connected equipment	7	RPC basic display module (BDM)
3	Case ventilation, both sides (Optional)	8	Monitoring station
4	Rack PDU array	9	Network connection (10 MB/100 MB/1 GB)
5	Sensors—integrated and modular		

Figure 2.2 Horizontal Rack PDU Configuration

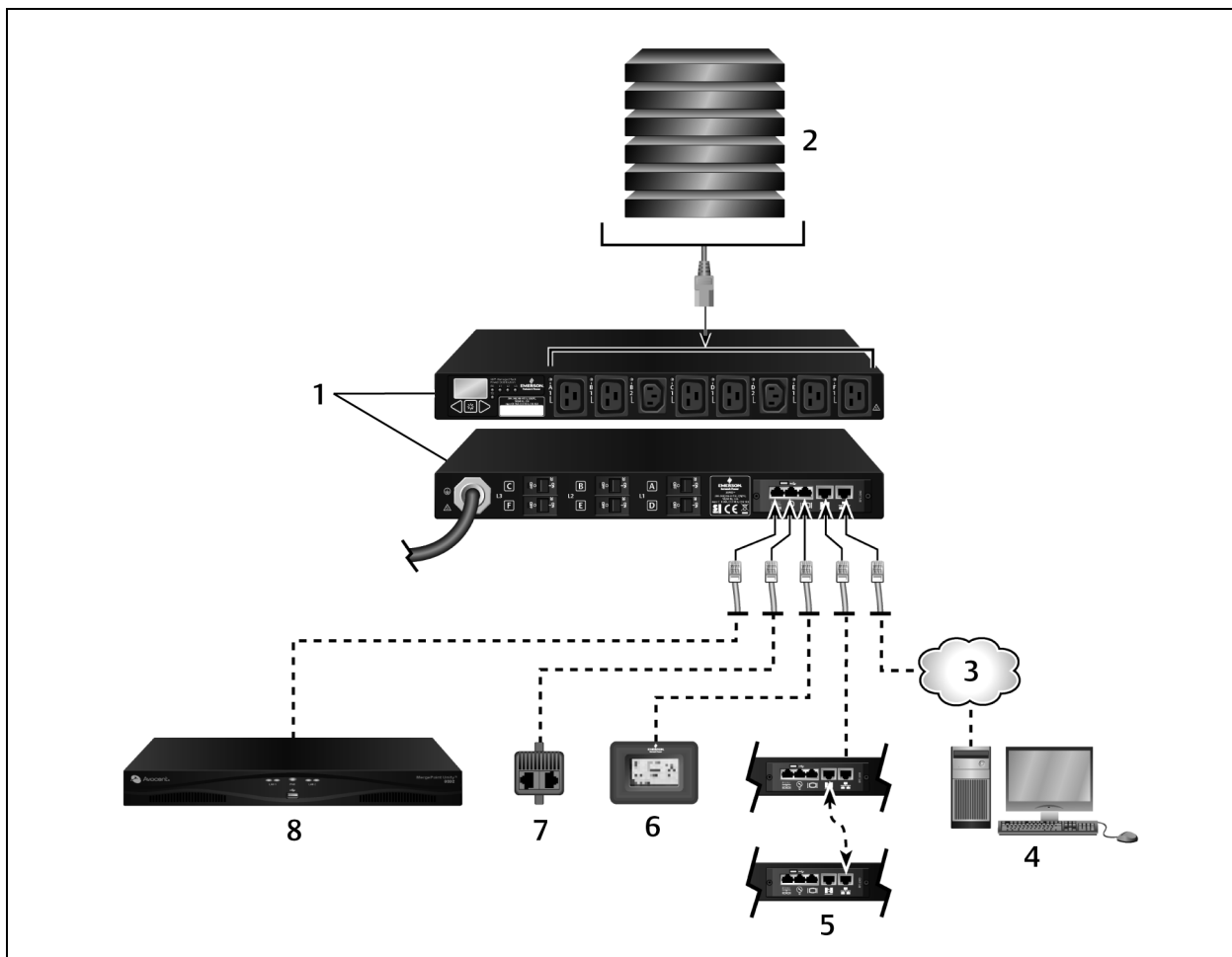

Table 2.2 Horizontal Rack PDU Configuration Descriptions

ITEM	DESCRIPTION	ITEM	DESCRIPTION
1	Horizontal rack PDU	5	Rack PDU array
2	Connected equipment	6	RPC basic display module (BDM)
3	Network connection (10 MB/100 MB/1 GB)	7	Sensors—integrated and modular
4	Monitoring station	8	Serial appliance

## 2.6 General Characteristics

The following are general characteristics of the rack PDU:

- Input ampacities include 16A or 32A for CE Marked versions and 12A to 48A for UL Listed versions.
- Single-phase and three-phase.
- Input voltages include 100-120 VAC, 120/208 VAC, 200-240/415 VAC.
- Receptacle types include NEMA 5-20, IEC 60320 C13 and IEC 60320 C19.
- Input power connection supports a highly flexible fixed power cord or hard-wired connection to the user accessible terminal block.

## 2.7 Model Types

There are four types of Vertiv™ MPH2™ Rack PDU. All models provide power distribution and include input and branch metering.

- Type B Rack PDU metered: Provides metering of input and branches.
- Type C Rack PDU metered, receptacle-switched: Provides metering of input and branches and individual power on/off control of each receptacle.
- Type M Receptacle-metered: Provides metering of input, branches and receptacles.
- Type R Receptacle-metered, receptacle-switched: Provides metering of input, branches and receptacles. Provides individual power on/off control of each receptacle.

## 2.8 Appearance and Components

### 2.8.1 RPC2™ module controls and indicators

The Vertiv™ MPH2™ Rack PDU is monitored and managed by the factory-installed RPC2 communications module. This manual presents information about the functions and features of the rack PDU. For details on operating the rack PDU through the RPC2 communications module, refer to the RPC2™ Communications Module Installer/User Guide (SL-20841). The document is available at Vertiv's web site: [www.VertivCo.com](http://www.VertivCo.com).

**Figure 2.3 Rack PDU Major Monitoring and Management Features**

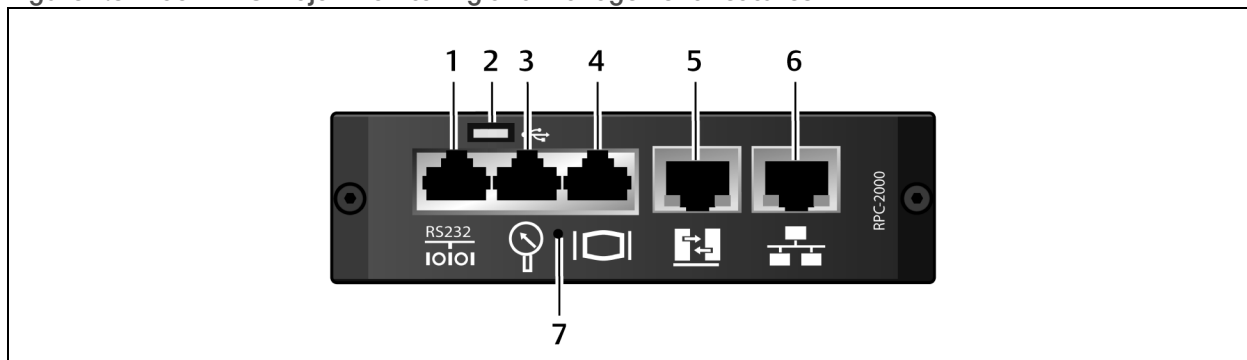

**Table 2.3 Rack PDU Major Monitoring and Management Features**

ITEM	DESCRIPTION	ITEM	DESCRIPTION
1	Serial port	5	Array link/management port
2	USB port	6	Network port
3	Sensor port	7	Access to Reset button
4	Display port		

### 2.8.2 LED indicators

The rack PDU has LEDs that indicate receptacle and branch status and system information. The LEDs flash, pulse or change colors to indicate an event or alarm condition. For details on how LEDs respond to events and alarms, see [Troubleshooting](#) on page 41

**NOTE: Receptacles on units with a "B" as the fourth character in the model name (MPHBxxxx) cannot be turned off and do not have LEDs at their receptacles.**

**NOTE:** Receptacles on units with an “M” as the fourth character in the model name (MPHMxxxx) cannot be turned off.

### 2.8.3 On-board LCD controls and indicators

The rack PDU has an integrated, on-board LCD and touch-key interface that can be used to view information about the rack PDU. The information available depends on the type of rack PDU. For additional information about the on-board LCD, see [Operation](#) on page 25.

### 2.8.4 Power components

The number of receptacles and circuit breakers depend on the model of the rack PDU. For example, units with a “B” as the fourth character in the model name do not have LEDs at their receptacles.

**Figure 2.4** Type B Rack PDU Model Example

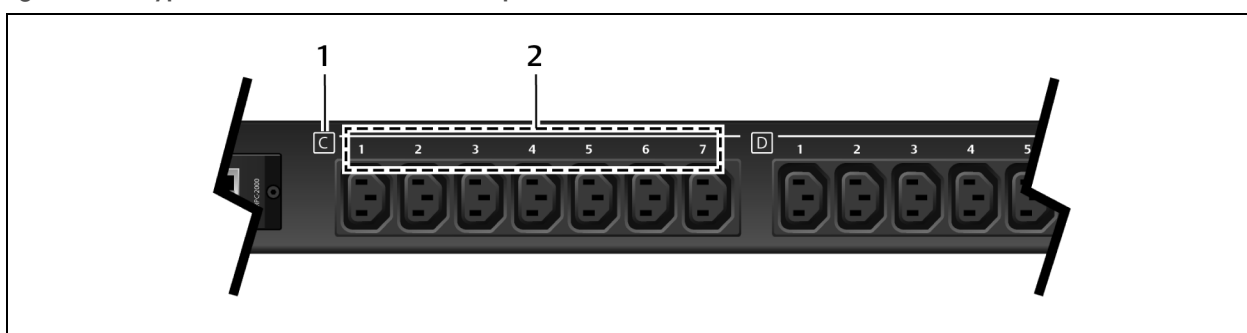
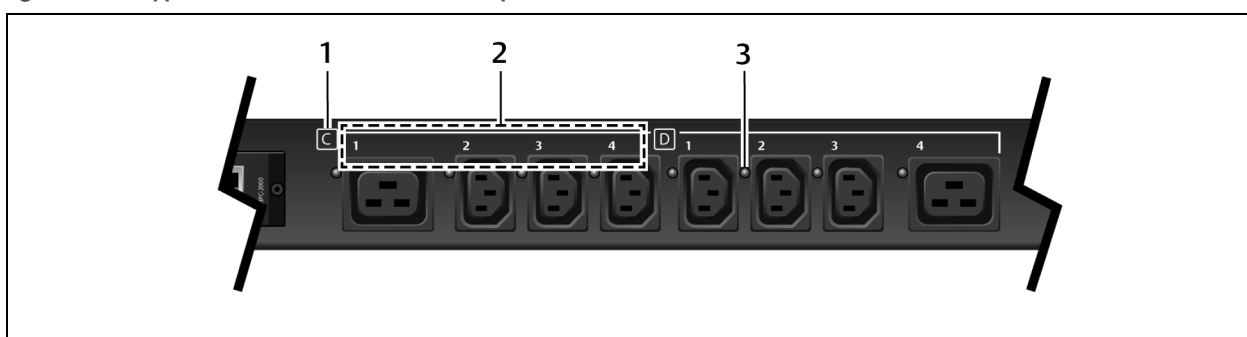

**Table 2.4** Type B Rack PDU Model Example

#### Descriptions

ITEM	DESCRIPTION
1	Branch identification
2	Receptacle identification

**Figure 2.5** Type R Rack PDU Model Example



**Table 2.5 Type R Rack PDU Model Example**

**Descriptions**

ITEM	DESCRIPTION
1	Branch identification
2	Receptacle identification
3	Receptacle-status LED

**2.8.5 Branch overcurrent protection**

Models having greater than 20A input-current rating are equipped with branch overcurrent protection, utilizing UL 489-listed hydraulic-magnetic circuit breakers with a flush-mount, rocker-style actuator. This protects each receptacle group against overload and short circuits by interrupting the fault current flowing in the line-to-line, line-to-neutral and line-to-PE conductors of the branch circuits. The branch circuit breaker ratings apply over the full, rated operating temperature and frequency.

The flush-mount breakers guard against accidental trips that could interrupt power to the connected load. Manually tripping a breaker requires a small, flat blade, such as a screw driver (see [Opening and Closing Circuit Breakers](#) on page 36.)

Low-profile circuit breakers are used on all rack PDU with two or three branch circuits less than 240 VAC rating in a line-neutral configuration. Standard-profile circuit breakers are used on rack PDU with six branch circuits or having a 240 VAC rating. Each type of circuit breaker is a rocker style as illustrated in the following figure.

The branch circuit breaker labeling (A through F) shows which receptacles are protected by each specific breaker. For example, receptacles on Branch A are protected by the circuit breaker labeled A. Depending upon region and model, PDUs may also have labeling showing the phase associated with each circuit breaker.

**NOTE: The branch circuit breaker is not designed to be used as a disconnect device for the connected load.**

**Figure 2.6 Circuit Breaker Branch Identification**

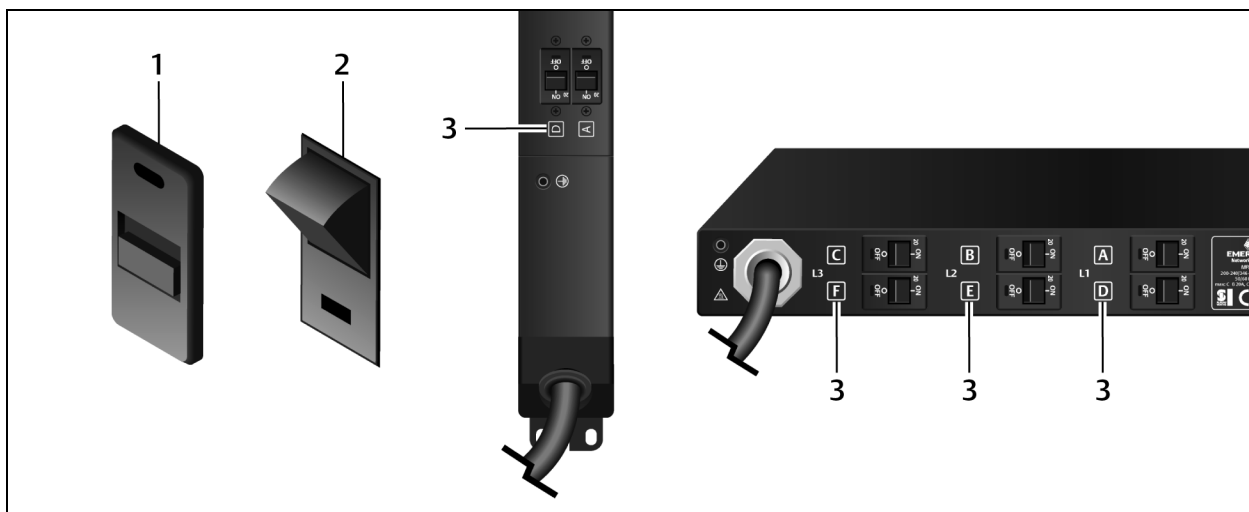

**Table 2.6 Circuit Breaker Branch Identification**

**Descriptions**

ITEM	DESCRIPTION
1	Low-profile circuit breaker actuator
2	Standard-profile circuit breaker actuator
3	Branch identification

**2.8.6 Hard-wired connection features**

A rack PDU can be equipped with either a factory-installed input power cord or hard-wired connections. The hard-wired connection will be at one end of the unit. A terminal block in the hard-wired connection compartment is coded to aid in making the connections. A collar secures the input wire, providing strain relief for the terminal block connections. See [Disassembly to install an input-power cable](#) on page 14.

This page intentionally left blank.



## 3 INSTALLATION

An MPH2™ Rack PDU can be installed on the frame members of a rack enclosure using factory-supplied hardware. The unit can be installed on the face or the side of frame members. The unit can be mounted so that the power cord exits either the top or bottom of the rack enclosure.

**NOTE: Follow all local and national electrical codes, standards and recommended practices.**

### Disconnect Required for Hard-Wired MPH2™ Rack PDU Units

A readily-accessible input-power disconnect device must be installed near the MPH2™ Rack PDU.

### Input Power Location for MPH2™ Rack PDU Units with Factory-Installed Power Cords

The input-power socket must be installed near the MPH2™ Rack PDU and must be easily accessible.

## 3.1 Attaching Input Power Cords—Hard-wired Models Only

Units with hard-wired input power require attachment of input-power cords. See [Hard-wired models—Recommended Wiring Sizes](#) on page 15 for wire sizing.

Hard-wired models may be wired with or without conduit.

### 3.1.1 Attaching Input-power Cords without Conduit



**WARNING! Always verify circuits are de-energized before working with exposed conductors.**

1. Remove the end cap. It is held in place with two T10 Torx screws.
2. Remove the terminal block cover.
3. Loosen the strain-relief collar. It is held in place with two Phillips head PH1 screws.
4. Remove a section of the outer jacket and strip the insulation from the individual wires as required to fit into the terminal block.

Recommended stripping length for MPH2™ Rack PDU units rated less than 32 A is 9 mm; for MPH2™ Rack PDUs rated at 40 A or higher, an 11 mm strip length is recommended.

5. Slip the power cord through the hole in the end cap and through the strain-relief collar.
6. Loosen the terminal block screws.
7. Insert the wires into the terminal block according to the labeling inside the MPH2™ Rack PDU; tighten each terminal block screw after inserting a wire. Refer to [Terminal tightening torque](#) on page 16 for tightening torque.
8. Tighten the strain-relief collar around the input power cord. The cord's outer insulation jacket should extend through the bracket.
9. Replace the terminal block cover by either sliding it on or snapping it into place.
10. Reattach the end cap to the MPH2™ Rack PDU with the two screws removed in step 1.

**Figure 3.1 Disassembly to install an input-power cable**

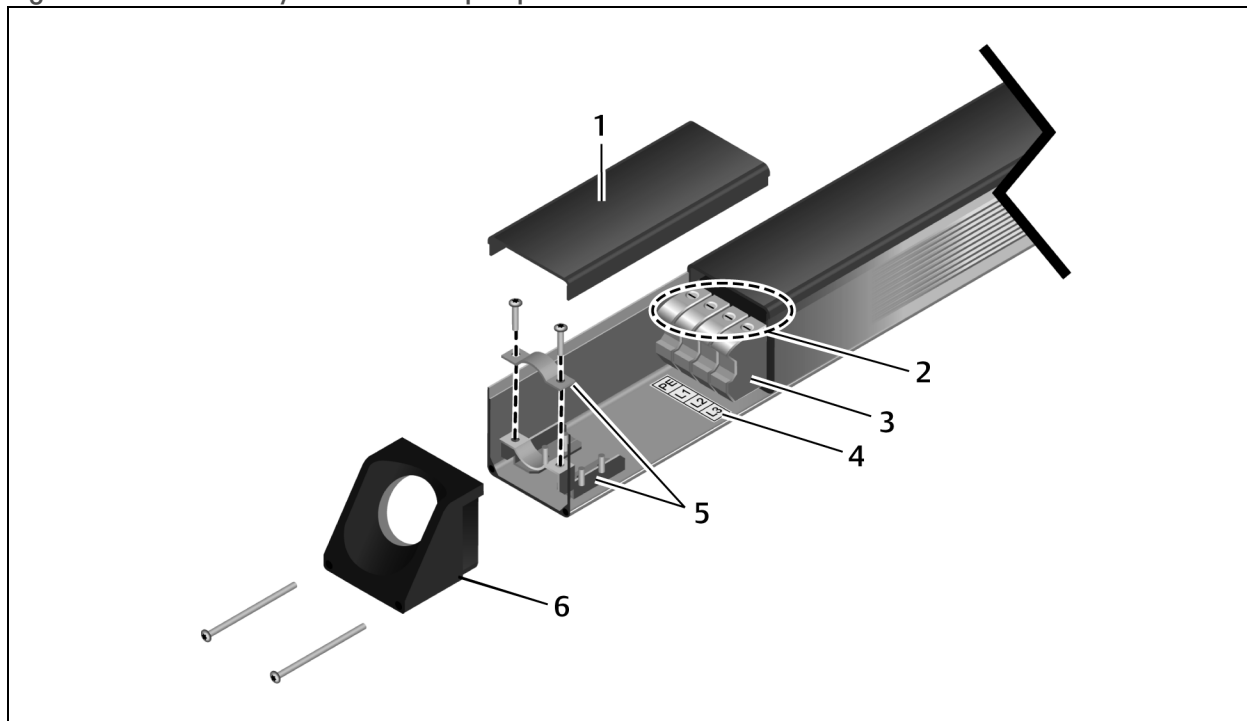

NUMBER	DESCRIPTION	NUMBER	DESCRIPTION
1	Terminal block cover	4	Terminal-block labels
2	Terminal-block screws	5	Strain-relief collar w/Phillips-head screws
3	Terminal block	6	End cap (attached with 2 screws)

### 3.1.2 Attaching Input-power Cords with Conduit

1. Remove the end cap. It is held in place with two T10 Torx screws.
2. Remove the terminal block cover.
3. Loosen the strain-relief collar. It is held in place with four nuts (see [Disassembly to install an input-power cable](#) on page 14).
4. Remove a section of the outer jacket and strip the insulation from the individual wires as required to fit into the terminal block.

Recommended stripping length for MPH2™ Rack PDU units rated less than 32 A is 9 mm; for MPH2™ Rack PDUs rated at 40 A or higher, a strip length of 11 mm is recommended.

5. Slip the stripped wire through the conduit connector, through the metal end plate, through the locknut and into the terminal block cavity.
6. Loosen the terminal block screws.
7. Insert the wires into the terminal block according to the labeling inside the MPH2™ Rack PDU; tighten each terminal block screw after inserting a wire. Refer to [Terminal tightening torque](#) on page 16 for tightening torque.
8. Install the terminal block cover, by either sliding it on or snapping it into place and sliding it firmly against the main body of the MPH2™ Rack PDU.
9. Attach the metal end plate to the MPH2™ Rack PDU with four screws provided in the kit.

10. Slide the conduit into the conduit connector.
11. Tighten the conduit connector until it grips the conduit and crimps it securely. See the conduit connector manufacturer's installation instructions for recommended locknut tightening torque values.

**Figure 3.2 Re-assembly to install an input power cable in conduit**

**Figure 3.3**

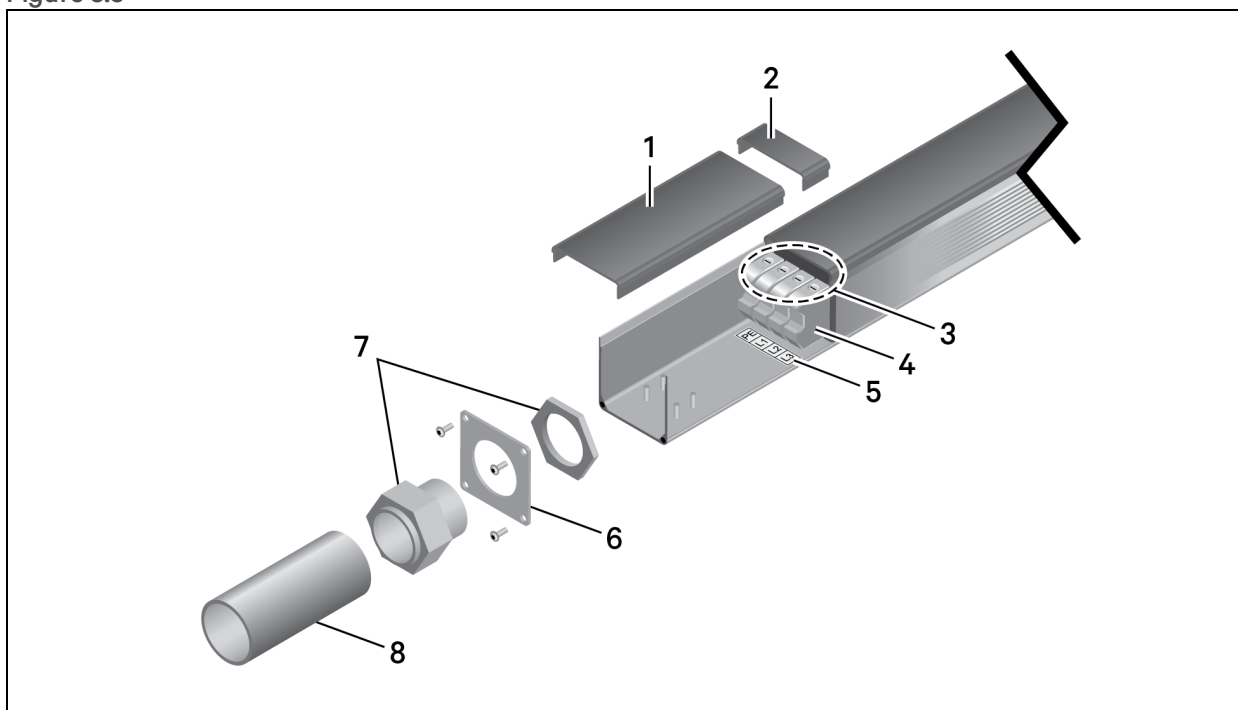

NUMBER	DESCRIPTION	NUMBER	DESCRIPTION
1	Terminal block cover	5	Terminal block labels
2	Filler cover	6	Metal end plate (attached with 4 screws)
3	Terminal block screws	7	Conduit connector (field-supplied) and locknut
4	Terminal block	8	Conduit (cable not shown)

**Table 3.1**

Hard-wired models—Recommended Wiring Sizes

UNITS	MPH2™ RACK PDU INPUT CURRENT RATING	
	≤32 A	>32 A
Metric	4 mm <sup>2</sup>	10 mm <sup>2</sup>
Imperial (US Standard)	10 AWG	6 AWG

**Table 3.2**

Terminal tightening torque

TIGHTENING TORQUE	MPH2™ RACK PDU INPUT CURRENT RATING	
	≤32 A	>32 A
Minimum	0.6 Nm (5.3 lb-in.)	1.5 Nm (13.3 lb-in.)
Maximum	0.8 Nm (7.1 lb-in.)	1.8 Nm (15.9 lb-in.)

### 3.2 Tool-less Mounting

For tool-less mounting, attach the mounts to the rear of the MPH2™ Rack PDU, then hang it in the rack as shown in the following figure. Tighten the screw attaching the mounting button to 17.7 lb-in. (2 Nm).

**NOTE:** Tool-less mounting brackets are not supplied. A range of brackets for Vertiv™ and other manufacturers' racks are available as accessories.

**Figure 3.4** Tool-less mounting

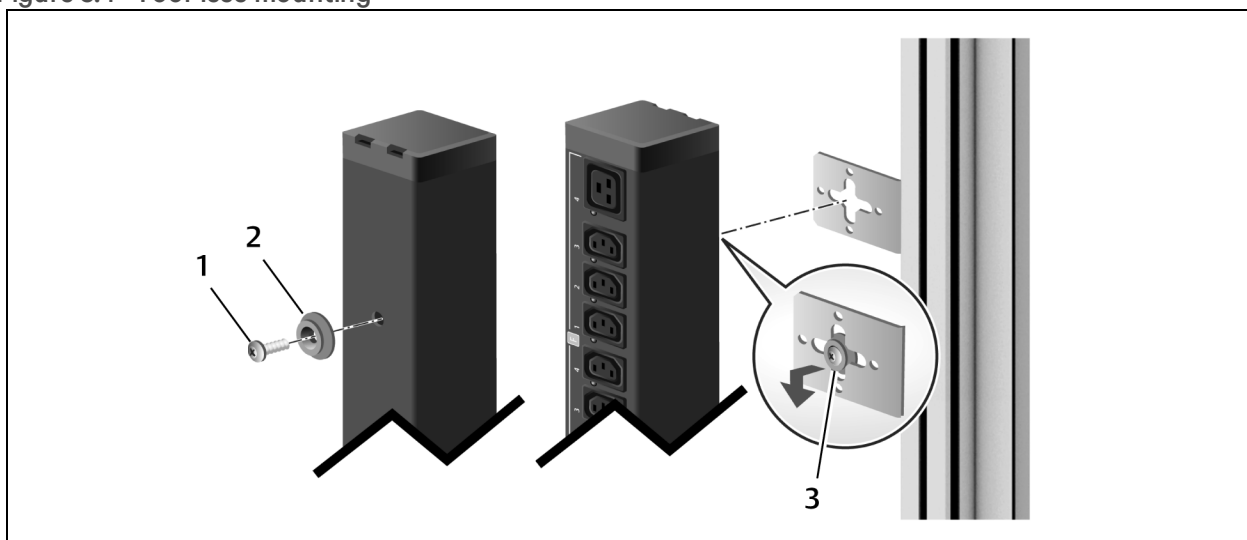

NUMBER	DESCRIPTION
1	Torx screw
2	Button mount
3	Insert button mount into keyhole slot.

### 3.3 Installing a MPH2™ Rack PDU in a Vertiv™® Rack

#### 3.3.1 Mounting Hardware and Tools Required

Factory-supplied

- 2 mounting brackets
- 2 mounting buttons
- 4 spring nuts

## User-supplied

For mounting a vertical MPH2™ Rack PDU:

- Phillips #2 screwdriver

For mounting a horizontal MPH2™ Rack PDU:

- Flat-blade screwdriver
- Torx screwdriver TX30
- Torque wrench
- Level

### 3.3.2 Mounting the Vertical MPH2™ Rack PDU

The vertical MPH2™ Rack PDU can be installed on a vertical or horizontal frame member in the rack.

1. Determine where in the rack the PDU will be installed.
2. Attach a bracket to each end of the PDU.
3. If mounting on horizontal frame members, attach the brackets in-line,  
- or -  
If mounting on a vertical frame member, attach the brackets at a right angle to the PDU.
4. Insert two spring nuts into the appropriate T-slot on the frame member. Position the spring nuts to accommodate screws inserted through slots in the brackets. To move the spring nuts, press down on each with a small, pointed object and slide each into position.
5. Hold the PDU in place and attach the top of the unit to the rack with tool-less fasteners.
6. Tighten the screws, using a torque setting of 46 lb-in (5.2 Nm).
7. Repeat steps 4-6 for the lower bracket on the lower end of the PDU.

**Figure 3.5** Installing vertical MPH2™ Rack PDU in a rack

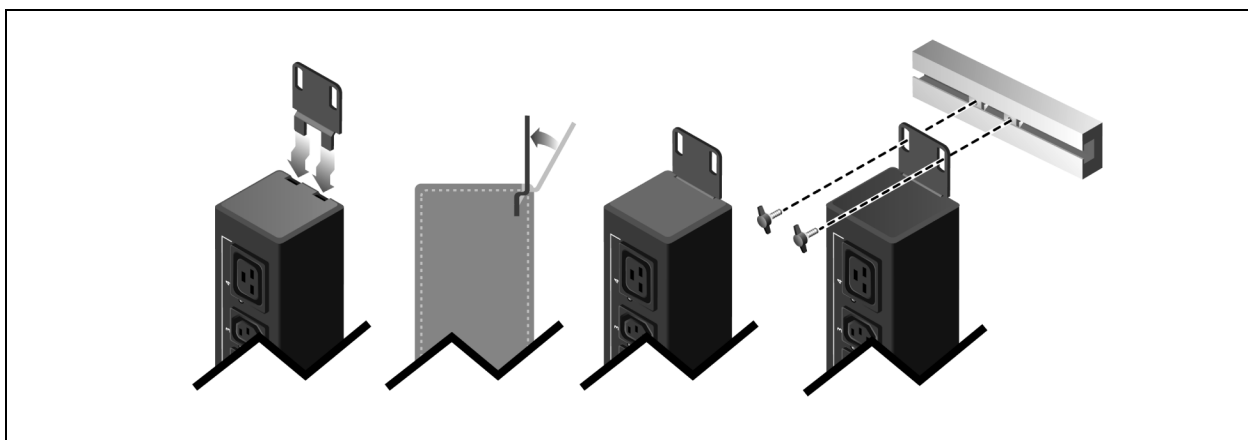

### 3.3.3 Mounting the Horizontal MPH2™ Rack PDU

The horizontal MPH2™ Rack PDU is installed on a vertical frame member in the rack.

1. Choose a position in the rack for the PDU and install four cage nuts into the respective slots.

2. Hold the MPH2™ Rack PDU over the desired mounting holes (now with the cage nuts), and route the input cable through the rack as desired.
3. Insert screws and use a Torx T30 screwdriver to tighten all of them. Leave the screws slightly loose for the time being,
4. Once all the screws are installed, tighten using a torque setting of 4 Nm or 35.4 lb-in.

**Figure 3.6** Installing horizontal MPH2™ Rack PDU in a rack

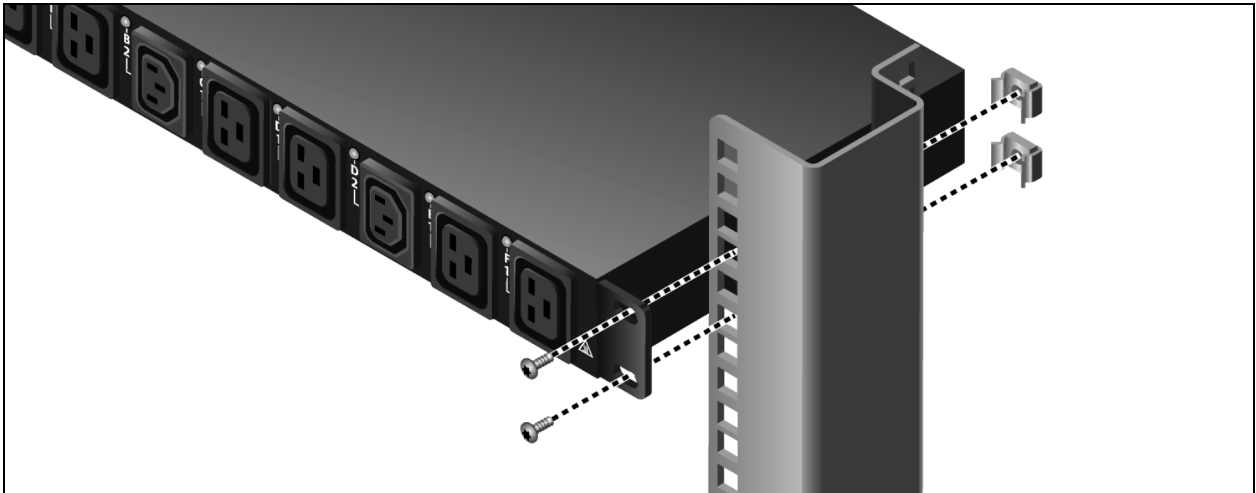

### 3.3.4 Mounting a Horizontal MPH2™ Rack PDU on Vertical Frame Member with Aluminum Extrusions

1. Choose a position in the rack for the PDU and install four spring nuts into the groove.
2. Use a level to check if the horizontal plane is maintained.
3. Set the distance to match the holes on the PDU, and hold the MPH2™ Rack PDU over the desired position (now with the spring nuts).
4. Route the input cable through the rack as desired.
5. Insert screws and use a Torx T30 screwdriver to tighten all of them. Leave the screws slightly loose for the time being.
6. Once all the screws are installed, tighten using a torque setting of 44.3 lb-in (5 Nm).

Figure 3.7 Installing horizontal MPH2™ Rack PDU in a rack with aluminum extrusions

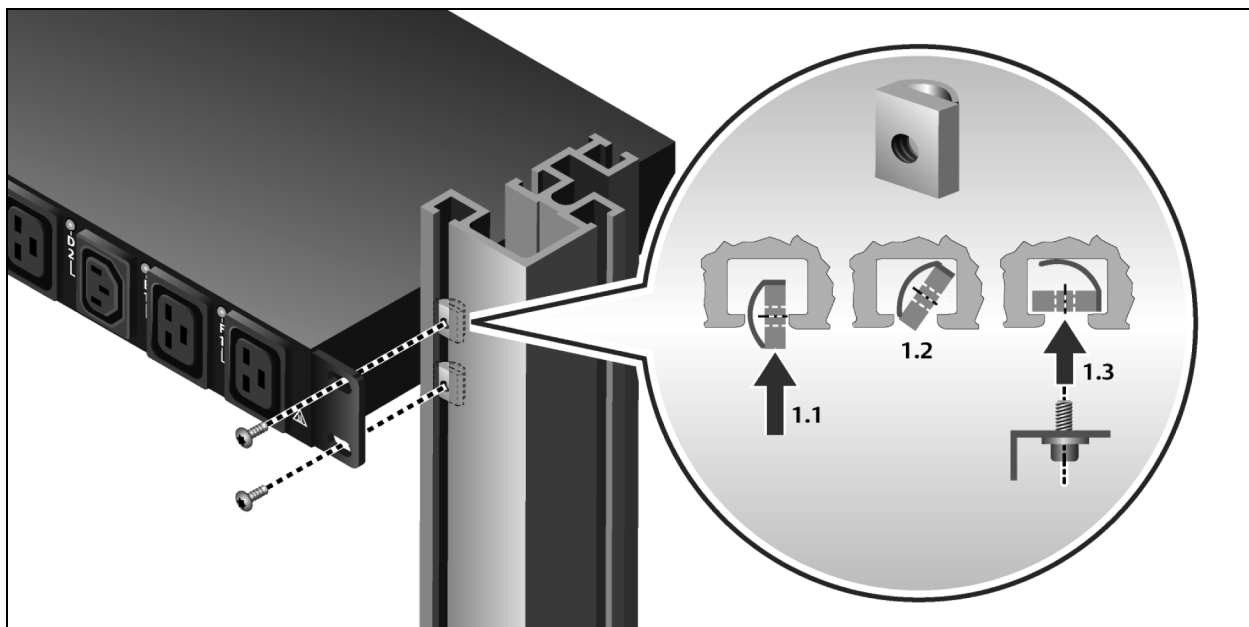

### 3.3.5 Rack Grounding strap

**NOTE:** Ensure that the safety-earth connection at the input-power-source receptacle is electrically connected before any equipment is connected to Vertiv™'s MPH2™ Rack PDU.

Units with factory-attached input-power cords have a grounding conductor internal to the case. The rack grounding strap establishes the same ground potential between the MPH2™ Rack PDU and the rack enclosure.

**NOTE:** The grounding strap may be used with rack PDUs that have attached input-power cords and units that have hard-wired input-power cords. The strap supplements the internal grounding conductor of the attached power-supply cord.

**NOTE:** When connecting multiple Class 1 devices, the ground leakage currents may be significant. The additional external ground connection helps reduce ground impedance between the MPH2 PDU and the rack enclosure. The rack-grounding strap may be ordered as an option.

The grounding strap may be particularly useful when the rack is on a raised floor.

Table 3.3

Ground-strap wire gauge by MPH2™ Rack PDU rating

RATING	WIRE SIZE		
	UL LISTED	CE MARKED	WORLD-WIDE (WW)
12 A	14 AWG	—	—
16 A	12 AWG	4.0 mm <sup>2</sup>	12 AWG or 4.0 mm <sup>2</sup>
24 A	10 AWG	—	—

RATING	WIRE SIZE		
	UL LISTED	CE MARKED	WORLD-WIDE (WW)
32 A	—	6.0 mm <sup>2</sup>	—
40 A	6 AWG	—	—
48 A	6 AWG	—	—

To connect a ground-strap to the rack:

1. Insert a spring nut into the rack frame near the grounding point on the MPH2™ Rack PDU (see [Tool-less mounting](#) on page 16 for inserting the spring nut).
2. Attach a ground wire to the rack with a screw, washer and lock washer. The screw is secured to the rack's frame with a spring nut.
3. Use a second field-supplied screw, washer and lock washer to secure the ground wire to the MPH2™ Rack PDU. The connection point is marked with an earth-ground symbol.

**NOTE:** The area beneath the lock washer should be void of paint or corrosion.

**Figure 3.8** Rack grounding-strap connection

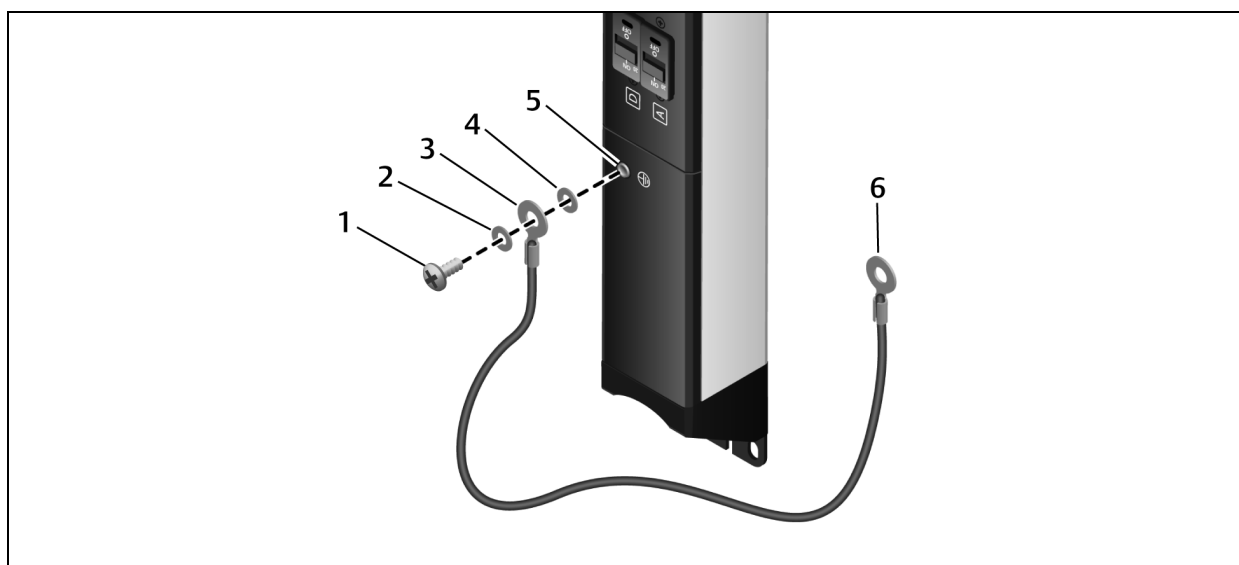

NUMBER	DESCRIPTION	NUMBER	DESCRIPTION
1	Ground-wire connection screw, M6 x 12	4	Lock washer
2	Washer	5	Ground-wire connection on MPH2™ Rack PDU (location may vary)
3	Ground-wire connector (to MPH2™ Rack PDU)	6	Ground-wire connector (to rack)

### 3.3.6 Recommended Input Branch Circuit Protection

A field-provided external circuit breaker must be installed upstream of the MPH2™ Rack PDU. The circuit breaker must be sized according to the input rating of the PDU. The circuit breaker rating must meet the values in the following table.

The external circuit breaker serves as the primary input power disconnect for the MPH2™ Rack PDU.



**Table 3.4 Upstream circuit breaker rating**

MAXIMUM CONTINUOUS INPUT CURRENT PER POLE	RATED CURRENT OF UPSTREAM CB
12 A	15 A (UL listed)
16 A	20 A (UL listed) 16 A (CE marked), WW)
24 A	30 A (UL listed)
32 A	32 A (CE marked)
40 A	50 A (UL listed)
48 A	60 A (UL listed)
63 A	63 A (CE marked)

### 3.4 Connecting Rack Equipment

**NOTE: Circuit breakers on Vertiv™'s MPH2™ Rack PDU are opened at the factory. The open circuit breakers help mitigate high inrush current when input power is first connected.**

To mitigate in-rush currents:

Close the branch circuit breakers and connect each load one at a time.

– or –

For MPH2™ Rack PDU-C and MPH2™ Rack PDU-R models, turn the receptacle off before connecting the load.

Verify that the equipment to be connected meets these requirements:

- Input power requirements of each load do not exceed the MPH2™ Rack PDU receptacle ratings.
- Input power cords are fully-engaged.
- Total equipment power consumption will not overload the MPH2™ Rack PDU.

To connect equipment to a MPH2™ Rack PDU:

1. Make sure that input power is installed in accordance with national and local electric codes.
2. Verify that all equipment is turned off.
3. If the MPH2™ Rack PDU will be monitored over a network, connect an Ethernet cable to the Network port on the RPC2.
4. Route the equipment power cables to the MPH2™ Rack PDU, following proper procedures and good practices, such as segregating power cables from control cables and adhering to bend radius limits specified by the equipment manufacturer.
5. Verify that the branch circuit breakers on the MPH2™ Rack PDU are open.
6. Connect the equipment input power cables to the MPH2™ Rack PDU.

**NOTE: All C13 and C19 receptacles on an MPH2™ Rack PDU are locking receptacles. Special locking power cords may be field-installed on the equipment and are available from Vertiv™. If non-locking power cords are used, the power cords should be secured through other methods to prevent unintended power interruption.**

7. Record where each piece of rack equipment is connected, using the branch and receptacle numbers on the MPH2™ Rack PDU.
8. Post the connection information on or near the rack and at any remote monitoring location.
9. Connect input power to the MPH2™ Rack PDU. On Types R, C and M models, the receptacle LEDs pulse RED indicating that the branch circuit breakers are open.
10. Verify that input power is present and the line-status LEDs are illuminated green and steady state. If any LEDs are not lit or are blinking, refer to **Table 5-2 - Line LED Troubleshooting**, page 39.
11. Close the branch circuit breakers. The receptacle LEDs should emit a non-blinking, steady state green light. If any LEDs are not lit or are blinking, refer to **Table 5-1 - Receptacle LED Troubleshooting**, page 38.
12. Turn on the connected devices one at a time and verify that each is operating properly.
13. Ensure that the specified ratings found on the rack PDU name plate are not exceeded.
14. Monitor and control the MPH2™ Rack PDU as detailed in the RPC2 user manual, SL-20841, available at [www.VertivCo.com](http://www.VertivCo.com).

### 3.5 Installing Optional Items

The following items may be added to an MPH2™ Rack PDU system but are not required:

- RPC Basic Display Module
- Liebert® SN temperature/humidity sensors

#### 3.5.1 RPC Basic Display Module Installation

The RPC Basic Display Module (BDM) provides local display of parametric data, including electrical status, temperature and humidity for all connected MPH2™ Rack PDUs. Display information is accessed via a navigation switch on the BDM. The RPC BDM is connected by cable to the MPH2™ Rack PDU, allowing the user to install the display to suit the local reading preferences. A 6.5-ft. (2-m) cable and general mounting provisions are provided. A single display can be used for up to four rack PDUs connected in a Rack PDU Array™.

The RPC BDM can be mounted in the rack with either the included hardware or with a cable tie through the slot on the back of the module. Either method permits moving the BDM to a different place in the same rack or to another rack.

**NOTE: See the RPC2™ Communications Module Installer/User Guide for more detailed information about operating the BDM.**

#### Included Hardware

- RPC BDM, 1
- Spring Nut M5, 1
- Spacer Sleeve, 1
- Mounting Button, 1
- M5 Screw, 1
- Cable Clip, 1

Figure 3.9 RPC BDM

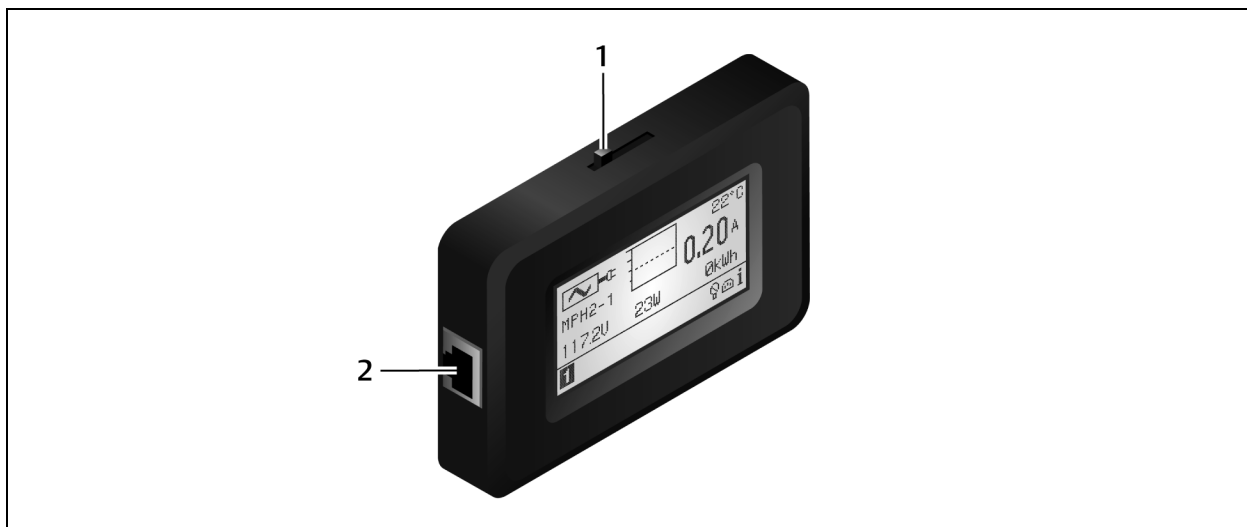

NUMBER	DESCRIPTION
1	Scan switch
2	RJ-45 communication and power input port

To install an RPC BDM in a rack:

1. Determine the mounting location on the frame member where the RPC BDM will be installed.
2. Insert a spring nut into a T-slot and flip it so that it is square in the slot as shown in the following figure.
3. Insert the MPH2™ Rack PDU screw into the spacer sleeve.
4. Insert the MPH2™ Rack PDU screw into the spring nut and tighten securely with a flat-head screwdriver.
5. Hang the RPC BDM on the screw with the hooded mounting slot on the back of the RPC BDM.
6. Connect the RPC BDM to the RPC2 with an Ethernet cable.
7. Be certain to connect the cable to the display port on the MPH2 rack PDU.

Figure 3.10 Inserting the spring nut into a T-slot

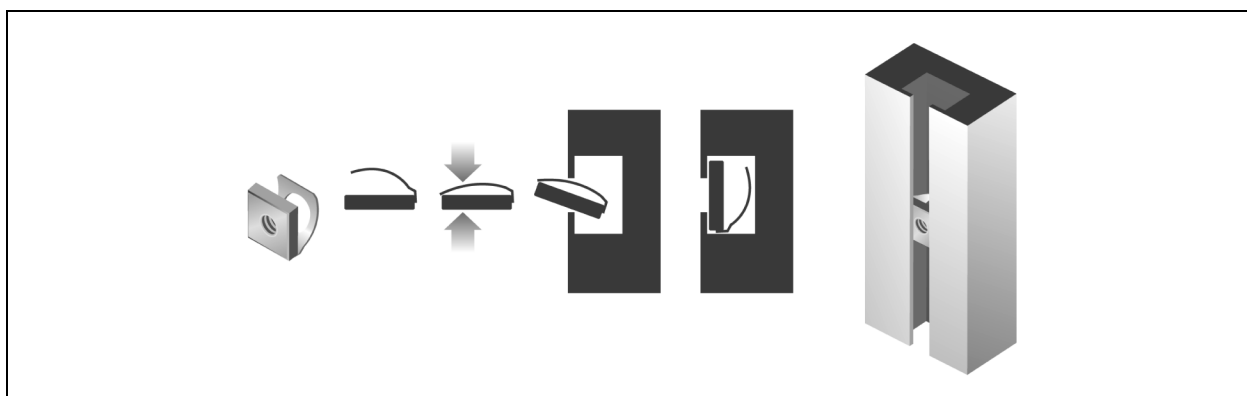

### 3.5.2 Temperature/Humidity Sensor Installation

Optional Liebert® SN temperature/humidity sensors are available to assist in monitoring conditions in the rack. Liebert SN sensors are designed for installation in Vertiv™ racks without tools, but each may be placed in any area to monitor temperature and humidity levels. Each connects to the RPC2 communications module, which makes readings available to other monitoring systems.

To install a sensor in a rack:

1. Insert the sensor bracket base into one end of the sensor support.
2. Snap the sensor into the other end of the sensor support.
3. Choose where in the rack to install the sensor assembly.

**NOTE: Vertiv™ recommends placing the sensor in the area of the rack that is likely to be warmest. That location helps determine extreme conditions that can cause equipment damage.**

4. Hold the sensor bracket on a T-slot on the Vertiv™ rack frame where the sensor will be placed.
5. Insert the included quarter-turn fastener through the rectangular hole in the sensor bracket base and into the T-slot.
6. Turn the fastener clockwise 90 degrees, completing a quarter of a turn.
7. Route the sensor cable to the RPC2 communications module and insert it into the card's external sensor port.

**NOTE: For more information, see the RPC2 user manual, SL-20841, available at <http://www.VertivCo.com>**

## 4 OPERATION

Vertiv™'s MPH2™ Rack PDU may be monitored and managed by the factory-installed RPC2 communications module. This manual presents information about the MPH2™ Rack PDU's functions and features. Refer to the RPC2 user manual, SL-20841, for details on using the RPC2 communications module to monitor and manage the MPH2™ Rack PDU. The documents shipped with the MPH2™ Rack PDU are available at Vertiv™'s Web site, [www.VertivCo.com](http://www.VertivCo.com).

The rack PDU's on-board LCD and the web-based interface display system are used to view measurements, metering information and data from optional Liebert SN temperature or temperature/humidity sensors. The RPC2 communications module and on-board LCD also display basic information about the MPH2™ Rack PDU, such as firmware version, unit rating, model number and serial number.

LEDs on the MPH2™ Rack PDU and an audible alarm also assist in providing alerts about events and alarm conditions. The keys under the on-board LCD are used to navigate to various information and to silence alarms.

### 4.1 Controls and Indicators

The MPH2™ Rack PDU also has LEDs that indicate receptacle and branch status and system information. LEDs flash, pulse or change colors to indicate an event or alarm condition.

**NOTE:** Units with a “B” as the fourth character in the model name (MPHBxxxx) do not have LEDs at their receptacles. The branch and receptacle LED behavior described in on page 41 and elsewhere in this document does not apply to these units. Receptacles on units with an “M” as the fourth character in the model name (MPHMxxxx) cannot be turned Off. LEDs at receptacles on these models are always either on continuously or flashing when input power is present.

Figure 4.1 On-board LCD and control keys

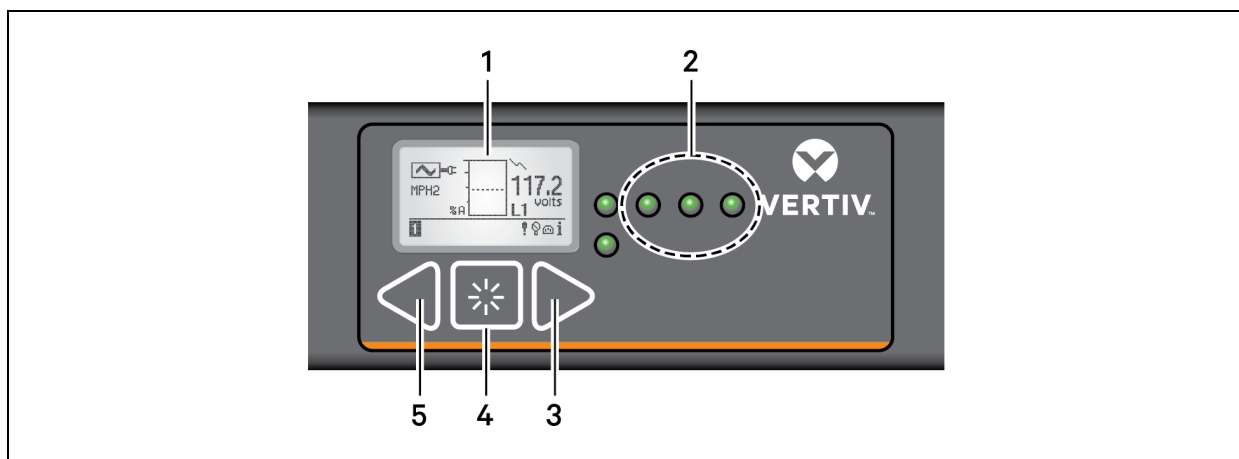

NUMBER	DESCRIPTION
1	On-board LCD
2	Line-input-status LEDs
3	Right-arrow key

NUMBER	DESCRIPTION
4	Select key
5	Left-arrow key

## 4.2 View Input-level Information

When the MPH2 is first turned on, the input level information of the main screen is shown on the display.

**NOTE:** If no key has been pressed after five minutes, the on-board LCD returns to the main screen.

**NOTE:** During a firmware upgrade: The Line LEDs flash red and green, and the rack PDU continues to receive and distribute power without interruption.

Figure 4.2 Input-level information (main screen)

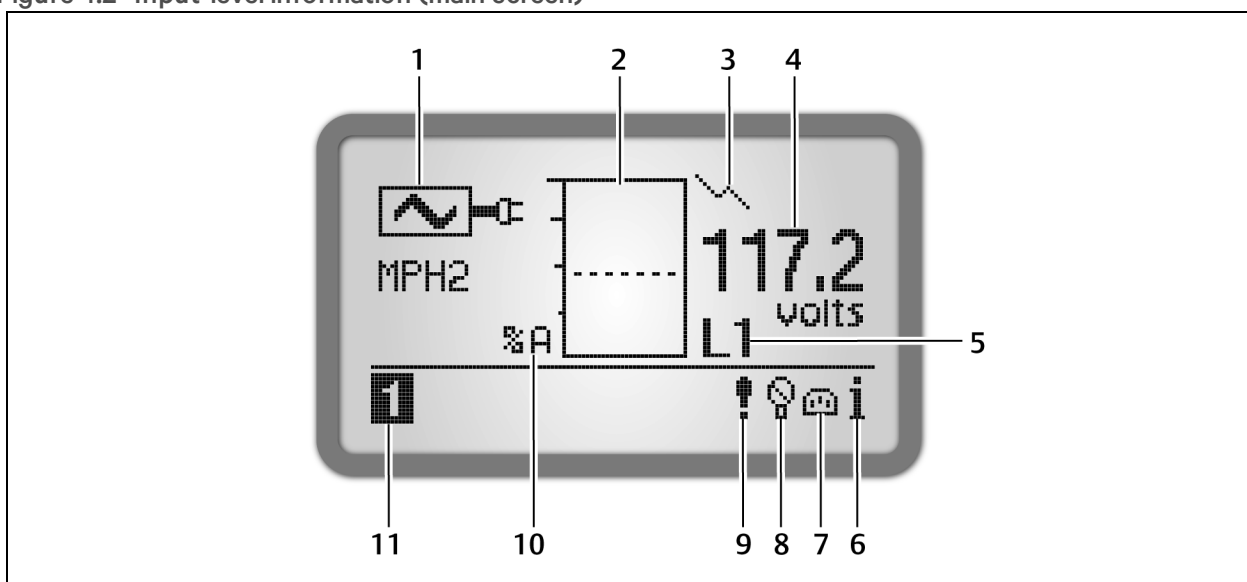

NUMBER	DESCRIPTION	NUMBER	DESCRIPTION
1	Input-level metered information icon	7	Receptacle icon
2	Bar graph of input current	8	Sensor icon
3	Link icon	9	Alarm icon
4	Input voltage	10	% Amperes used until alarm threshold.
5	Voltage phase	11	Unit identification (always shows unit 1)
6	Information icon		

### 4.2.1 Communication Link with RPC2

When power is cycled to the MPH2™ Rack PDU, it takes a few minutes to establish communication and load the configuration information from the RPC2 module, such as receptacle labels and IP and MAC addresses.

When configuration changes (such as turning-on/off a receptacle) require that the display update, the configuration wheel appears and spins.

Figure 4.3 Configuration in-progress wheel

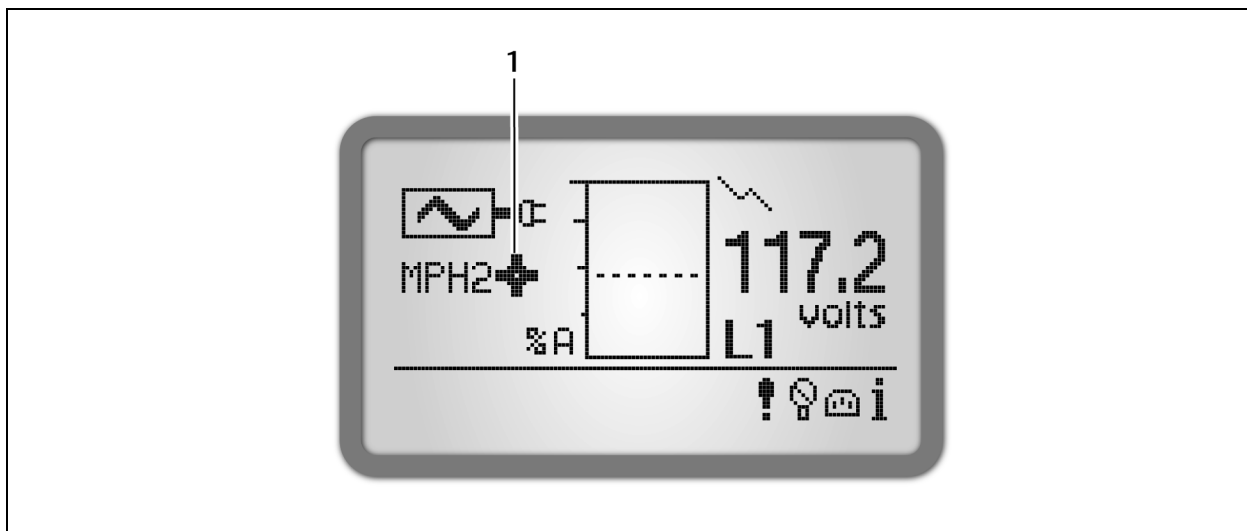

NUMBER	DESCRIPTION
1	Configuration wheel

### 4.3 View MPH2™ Rack PDU System Information

1. Use the arrow keys to highlight the Information icon.
2. Press the Select key to view the MPH2™ Rack PDU model number, serial number, firmware version, power rating and number of receptacles.

Figure 4.4 System information

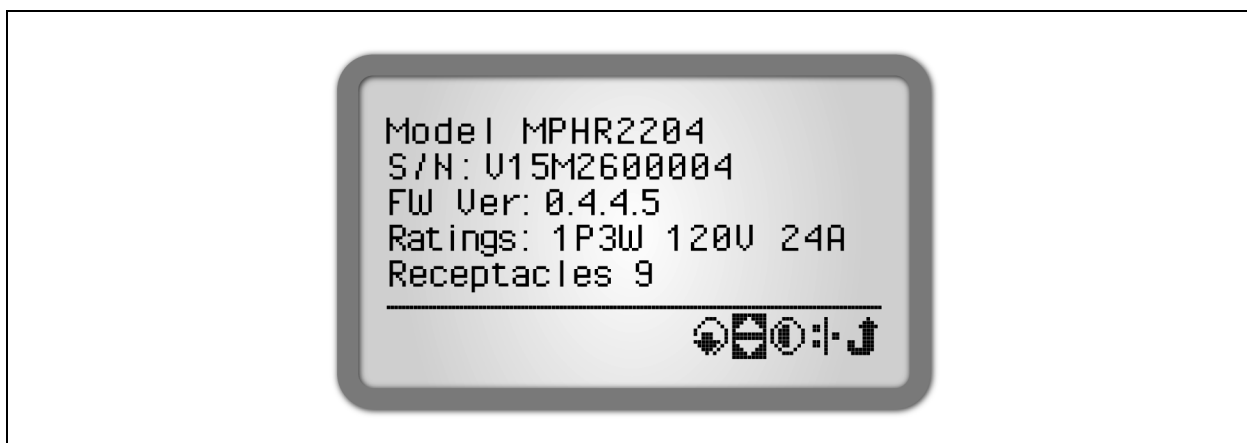

**NOTE:** The firmware version and other information in the preceding figure are examples only.

#### 4.3.1 System and Screen Options

On the system-information screen is a menu of icons that provides access to network information as well as system and display options.

Figure 4.5 System-info and Screen-option icons

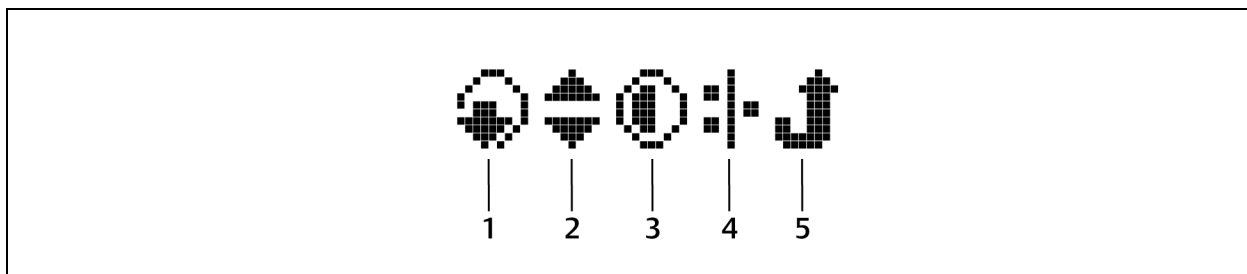

NUMBER	DESCRIPTION
1	Reboot/Restore-defaults icon
2	Flip screen orientation icon
3	Adjust screen contrast icon
4	System network icon
5	Up-to-previous-level icon

### 4.3.2 Rebooting

To reboot the system:

1. Use the arrow keys to highlight the Information icon and press the **Select** key.
2. Use the arrow key to highlight Reboot and press the **Select** key.

Figure 4.6 Reboot Options

Figure 4.7

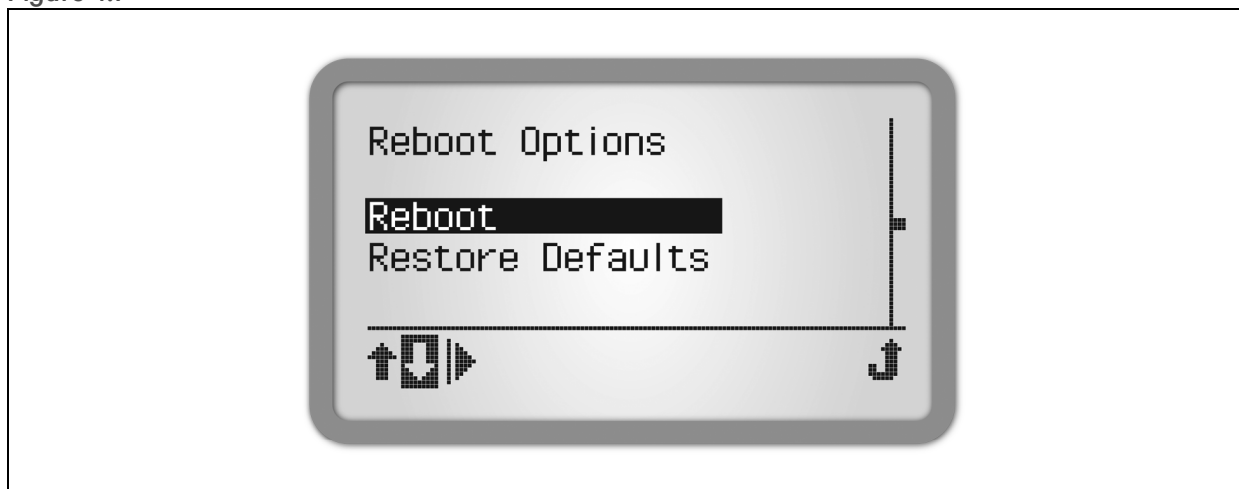

3. Use the arrow keys to highlight the up or down arrow on the bottom left and press the **Select** key to highlight *Reboot*.
4. Use the arrow keys to highlight the *Play* button and press the **Select** key.
5. At the confirmation screen, use the arrow keys to highlight the up or down arrow, and press the **Select** key to highlight *Yes/Reboot Now*, then press the **Select** key to reboot the system.



### 4.3.3 Restore System Defaults

To restore system defaults:

1. Use the arrow keys to highlight the Information icon and press the **Select** key.
2. Use an arrow key to highlight the *Reboot/Restore-Defaults* icon and press the **Select** key.

**Figure 4.8** Restore Defaults Selected On Reboot Options

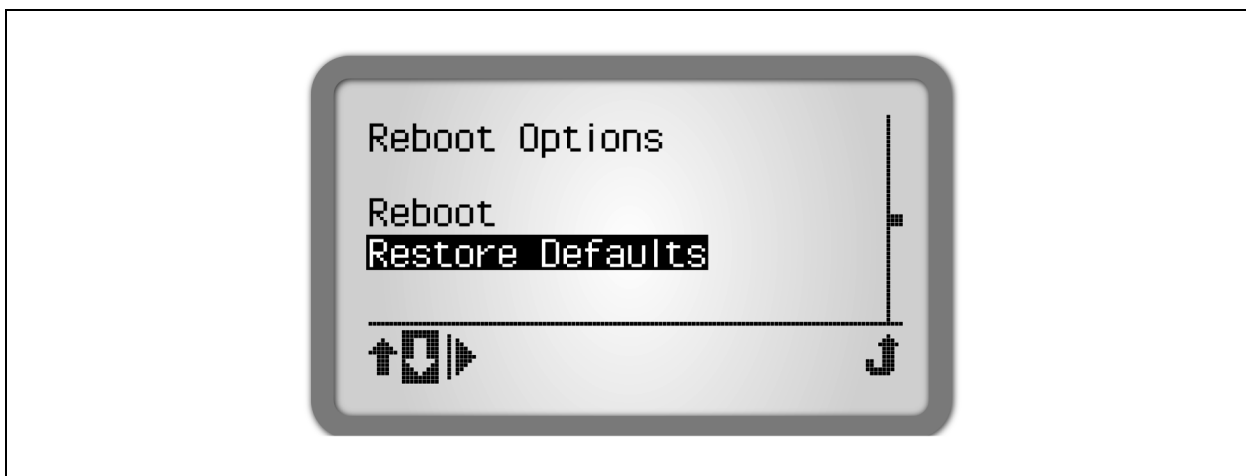

3. Use the arrow keys to highlight the *Reboot/Restore-Defaults* icon and press the **Select** key.
4. Use the arrow keys to highlight the up or down arrow on the bottom left and press the **Select** key to highlight *Restore Defaults*.
5. At the confirmation screen, use the arrow keys to highlight the up or down arrow, and press the **Select** key to highlight *Yes/Restore Defaults*, then press the **Select** key to restore the system default settings.

**Figure 4.9** Restore Defaults Confirmation

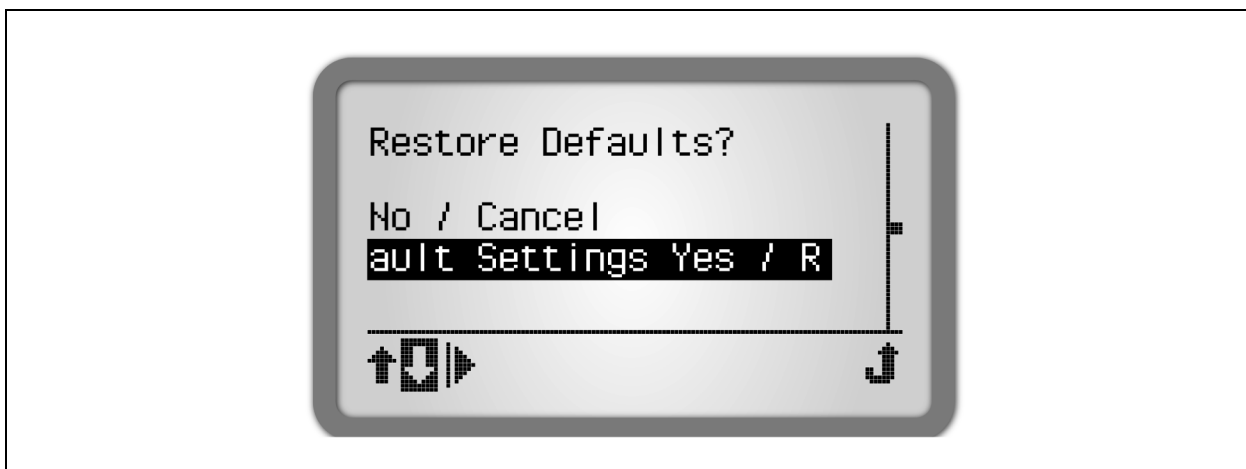

When the "Restore to Factory Defaults" command is initiated via the RPC2 module clients, the MPH2 rack PDU settings are returned to the factory default values as well.

**NOTE:** For detailed information about settings and about network- and protocol-related default settings for the RPC2 module, see the *RPC2 Communications Module Installer/User Guide*.

**Table 4.1 Factory-default settings**

LEVEL	SETTINGS	DEFAULT VALUE	UNITS	MODELS AFFECTED	NOTES
PDU	User Assigned Label	MPH2™ Rack PDU or Rack PDU <alpha>	—	All	RackPDU is default value the first time only. Allowed characters include alphanumeric, space, and ~!#\$_%+`'-= []\ :;'.\ /%^&*()@
	Asset Tag 1	<empty>	—	All	
	Asset Tag 2	<empty>	—	All	
	Overcurrent Alarm Threshold	45	%	All	% calculated from maximum input-current rating on nameplate. Default values are recommended for dual-corded server applications.
	Overcurrent Warning Threshold	40	%	All	
	Undercurrent Alarm Threshold	0	%	All	
	Unbalanced Load Alarm threshold	0	%	All 3-phase	
	Software Over Current Protection (SWOCP)	Disabled	—	R	Conditionally applies to unlocked and unloaded receptacles only.
Branch	User Assigned Label	Branch <alpha>	—	All	Allowed characters include alphanumeric, space, and ~!#\$_%+`'-= []\ :;'.\ /%^&*()@
	Asset Tag 1	<empty>	—	All	
	Asset Tag 2	<empty>	—	All	
	Overcurrent Alarm Threshold	95	%	All	% calculated from CB rating. Refer to nameplate for maximum branch current rating.
	Overcurrent Warning Threshold	90	%	All	
	Undercurrent Alarm Threshold	0	%	All	
	SWOCP	Disabled	—	R	Conditionally applies to all unlocked and unloaded receptacles only for this branch.
Receptacle	User Assigned Label	Receptacle <number>	—	All	Allowed characters include alphanumeric, space, and ~!#\$_%+`'-= []\ :;'.\ /%^&*()@
	Asset Tag 1	<empty>	—	All	
	Asset Tag 2	<empty>	—	All	
	Overcurrent Alarm Threshold	95	%	M,R	Configurable per receptacle. % calculated from maximum receptacle current rating on nameplate.
	Overcurrent Warning Threshold	90	%	M,R	
	Undercurrent Alarm Threshold	0	%	M,R	
	Power Up State	Restore	—	C,R	Restore returns receptacle power state to last programmed state after expiration of Power On Delay.
	Power On Delay	0	seconds	C,R	The delay timing begins after measurement stability is achieved.
	Power Cycle Delay	8	seconds	C,R	A Power Cycle turns off power to the receptacle for the specified delay.
	Post On Delay	0	seconds	C,R	Delay before RPC2 issues command to power on receptacle.
	Post Off Delay	0	seconds	C,R	Delay before RPC2 issues command to power off receptacle.
Software Over Temperature Protection (SWOTP)	Disabled	—	C,R	Unconditionally applies regardless of locked/unlocked and loaded/unloaded status. At least one temperature sensor is required.	

LEVEL	SETTINGS	DEFAULT VALUE	UNITS	MODELS AFFECTED	NOTES
	SWOTP Delay	10	seconds	C,R	Delay required for persistent over-temperature alarm condition before SWOTP triggered.
	SWOTP Scope	Local	—	C,R	Local = affects only PDU connected to the temperature sensor that triggered SWOTP. Array = affects all PDUs regardless of temperature sensor that triggered SWOTP.
	Criticality	Critical	—	C,R	Affects power control when a member of a receptacle group.
	Locked/Unlocked	Unlocked	—	C,R	Affects authorization to manage power control and behavior of SWOCP.

#### 4.3.4 Determine IP Address, MAC Address and Firmware Version

1. Use the arrow keys to highlight the Information icon and press the Select key.
2. Use the arrow key to highlight the Network icon and press the Select key to view the IP address, MAC address, firmware, time and date.

Figure 4.10 IP address, MAC address and Firmware Information Example

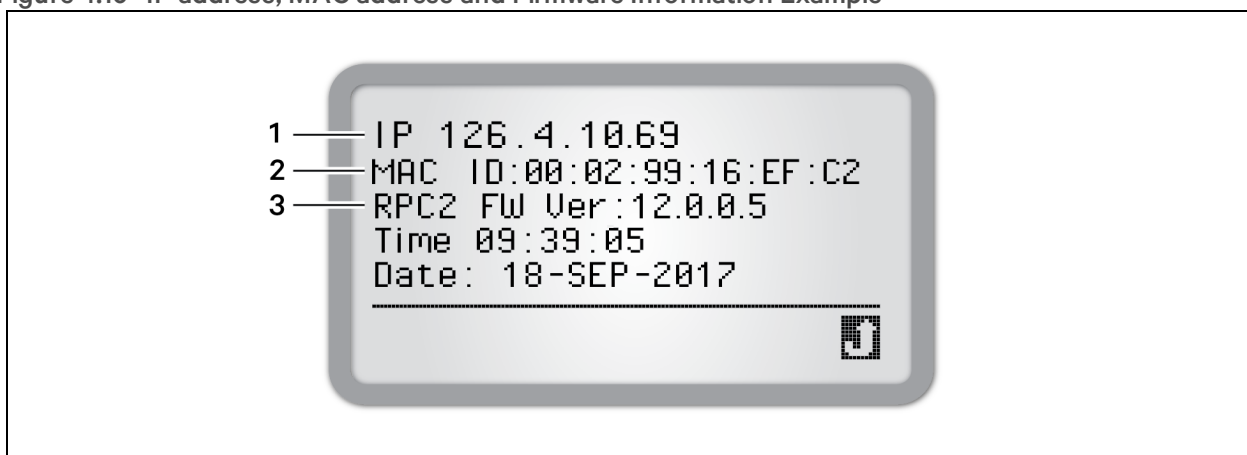

NUMBER	DESCRIPTION
1	IP address
2	MAC address
3	Agent firmware type and version

**NOTE:** The preceding illustration is an example of network information.

#### 4.3.5 Adjust the Contrast of the On-board LCD

**NOTE:** Contrast adjustment may help improve display legibility in a high-temperature environment.

The on-board display is factory-set to be easily viewed in lighting conditions found in most work places, however the contrast can be changed to suit user preference.

1. Press any key to activate the display.
2. Use the arrow keys to highlight the Information icon, and press the Select key.
3. Use the arrow keys to highlight the Contrast icon, and press the Select key.

4. Use the arrow keys to highlight the up/down arrow, and press the **Select** key to increase or decrease contrast.
5. When the contrast is satisfactory, highlight the Return to Previous Level icon, and press the **Select** key to return to the system-information screen.

**NOTE: These steps also apply to the RPC BDM.**

#### 4.3.6 Adjust the Orientation of the On-board display

Because mounting of the MPH2™ Rack PDU in the rack may vary, the on-board display may be “flipped” to change the screen orientation for viewing ease.

1. Press any key to activate the display.
2. Use the arrow keys to highlight the Information icon, and press the **Select** key.
3. Use the arrow keys to highlight the Flip-orientation icon, and press the **Select** key to flip the screen orientation.
4. Highlight the Return to Previous Level icon and press the **Select** key to return to the input-level screen.

**NOTE: These steps also apply to the RPC BDM.**

#### 4.4 View Active Alarms

**NOTE: The most-recent alarms are at the top of the list.**

1. Use the arrow keys to highlight the Alarm icon, and press the **Select** key to display a list of active alarms on the MPH2 rack PDU.
2. Use the arrow keys to highlight the up/down arrow, and press the **Select** key to highlight an alarm.
3. Highlight the Play button, and press the **Select** key to display the details of the specific alarm alarm.

**Figure 4.11 Alarm List Example**

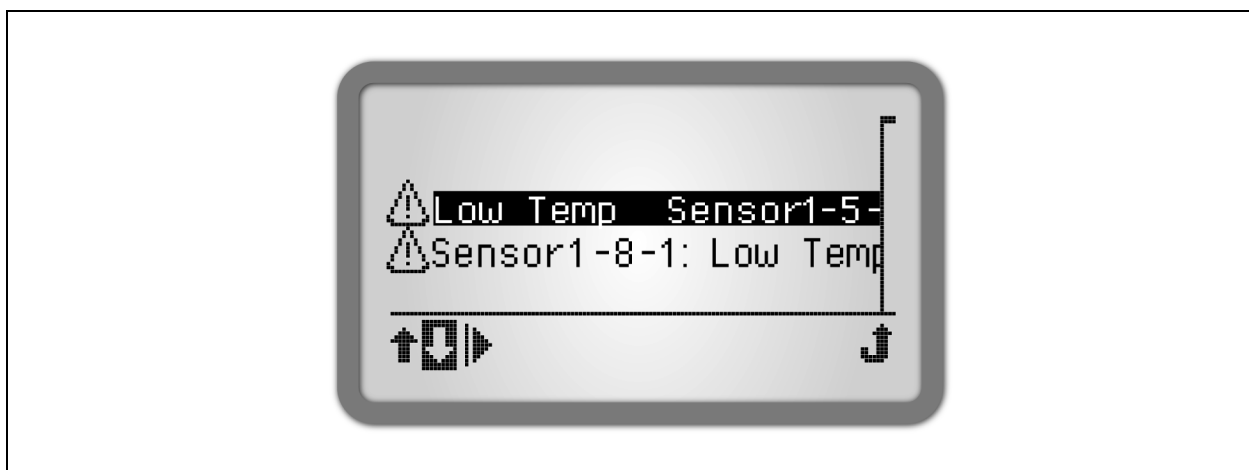

##### 4.4.1 Silence an Audible Alarm

To silence an audible alarm, press any of the three navigation keys below the display.

See on page 41 for details about how the LED interface signifies events and alarms.

## 4.5 View Branch-level Information

1. At the input-level (main) screen, highlight the unit-identification number, and press the **Select** key to display the branch letters along the bottom-left.
2. Use the arrow keys to highlight the letter of the branch to view, and press the **Select** key to display information about the selected branch.
  - To display more details about the selected branch, highlight the Information icon and press the **Select** key.
  - To return to the previous level view, highlight the Return icon and press the **Select** key.

Figure 4.12 Branch information

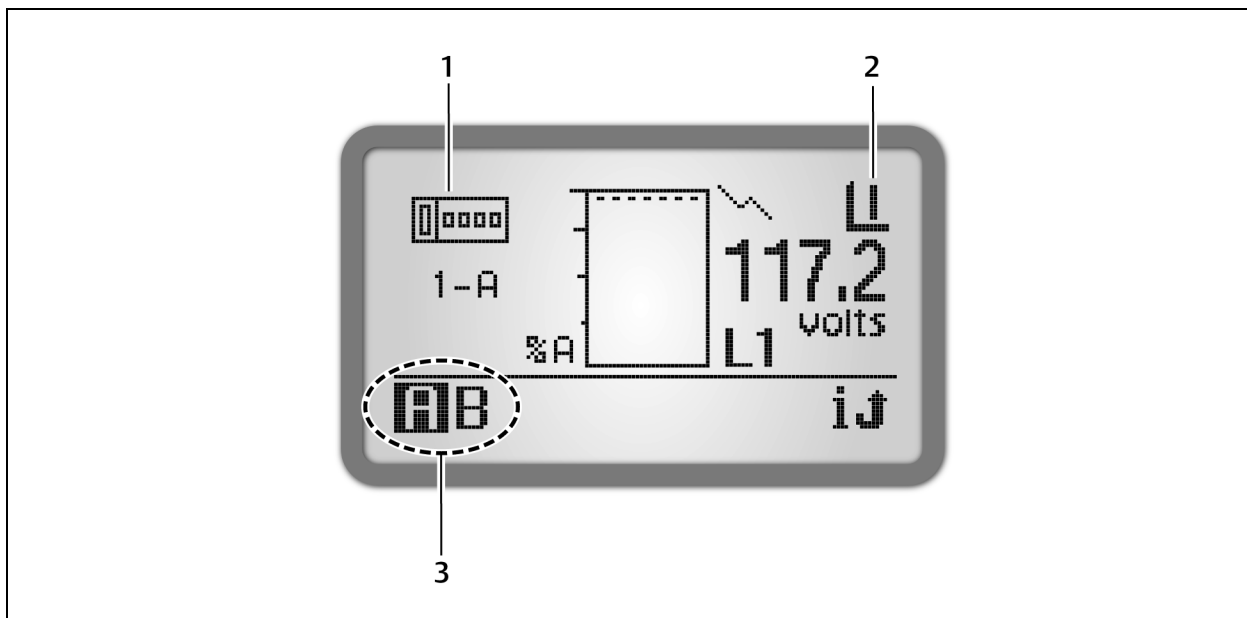

NUMBER	DESCRIPTION
1	Branch-level information icon
2	Branch circuit-breaker status icon I = closed circuit breaker O = open circuit breaker
3	Branches (two shown, A and B)

## 4.6 View Receptacle-level Information

1. At the input-level (main) screen, highlight the Receptacle icon, and press the **Select** key to display the receptacle list.

Figure 4.13 Receptacle list

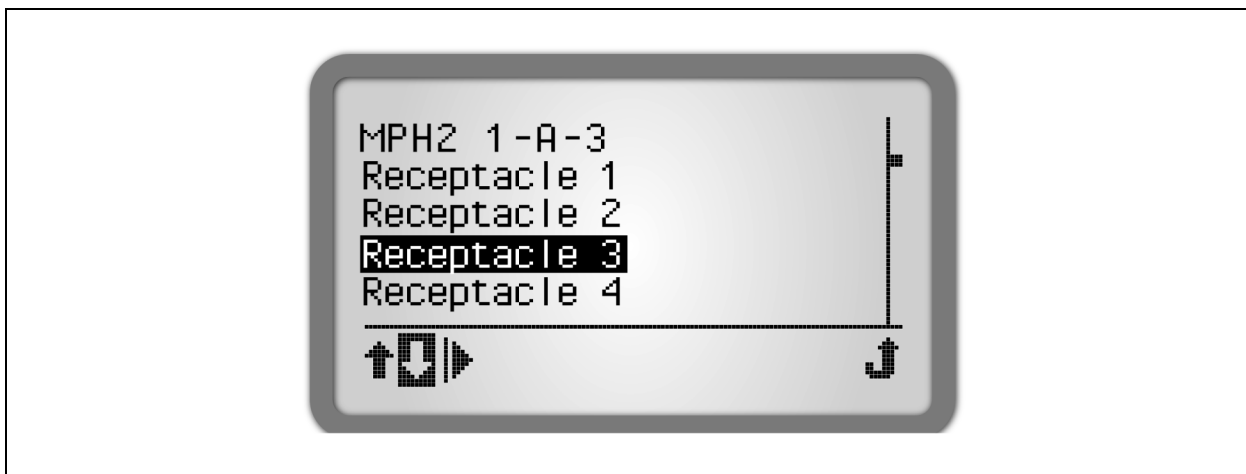

2. Use the arrow keys to highlight the up/down arrow at the bottom-left, and press the **Select** key to highlight a receptacle.
3. Highlight the Play button, and press the **Select** key to display the receptacle information. The receptacle numbers display along the bottom-left, and the number of the selected receptacle number flashes. See the following figure.
4. To view a different receptacle, highlight the number of the receptacle, and press the **Select** key.
  - To display more details about the selected receptacle, highlight the Information icon and press the **Select** key.
  - To return to the previous level view, highlight the Return icon and press the **Select** key.

Figure 4.14 Receptacle information

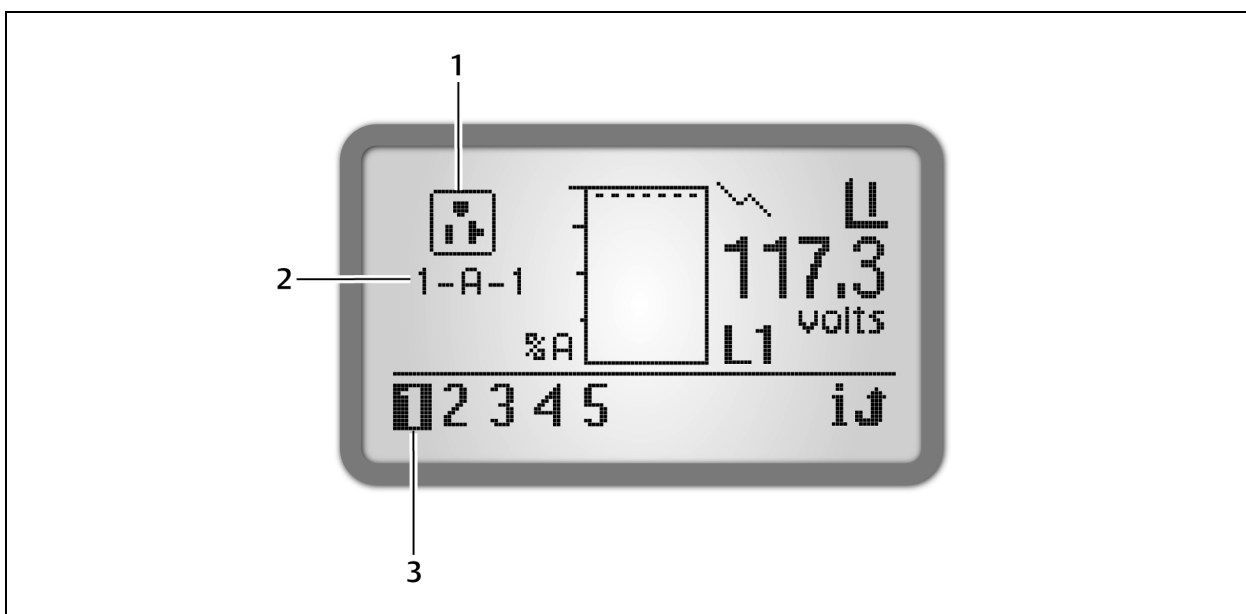

NUMBER	DESCRIPTION
1	Receptacle-level information icon
2	Receptacle identification: 1 = MPH2™ Rack PDU #1 A = Branch A 1 = Receptacle #1
3	Receptacle list (receptacle #1 of 5 is selected)

### 4.7 View Sensor Information

1. At the input-level (main) screen, highlight the Sensor icon, and press the **Select** key to display a list of the sensors, in the order of their identification number.
2. Use the arrow keys to highlight an up/down arrow at the bottom-left, and press the **Select** key to highlight a receptacle.
3. Highlight the Play button, and press the **Select** key to display the humidity-sensor information:
  - Percentage and severity of humidity.
  - Sensor identification and label (serial number).

**NOTE:** The default label is the sensor’s serial number, but can be changed through the Web interface.

Figure 4.15 Sensor List Example

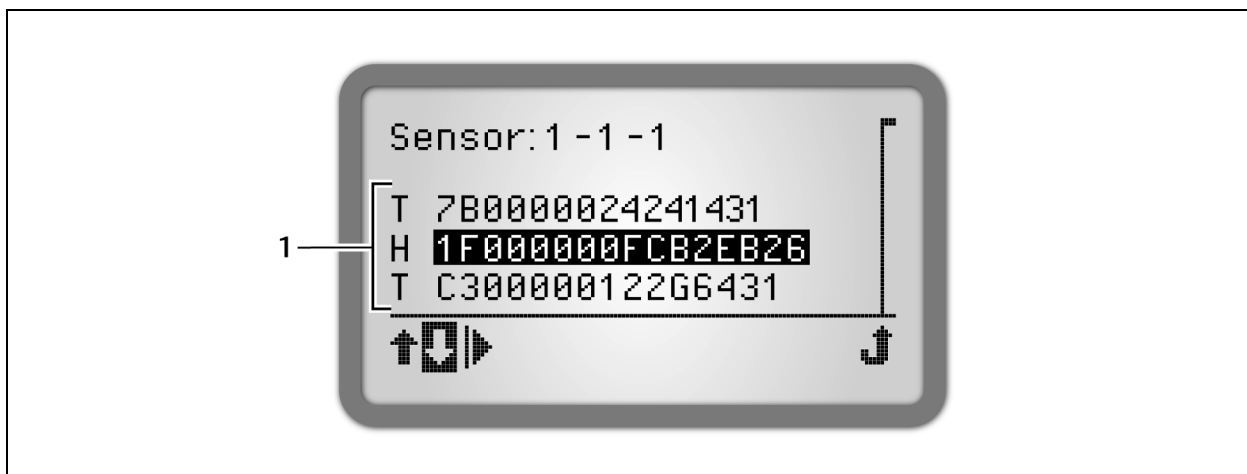

NUMBER	DESCRIPTION
1	Sensors connected to the MPH2™ Rack PDU. (two temperature sensors and one humidity sensor in the example)

Figure 4.16 Sensor Information Example

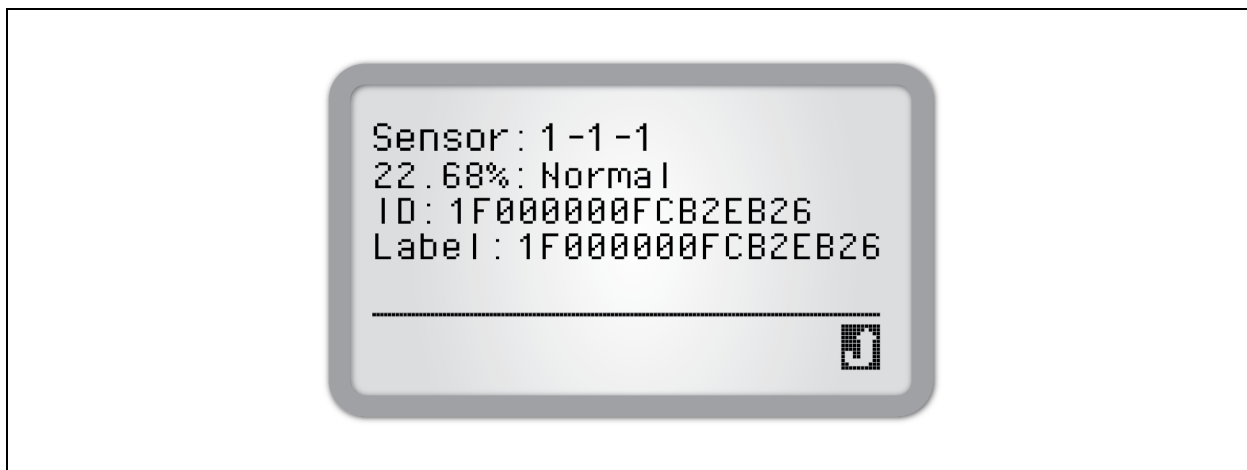

### 4.8 Opening and Closing Circuit Breakers

To manually trip a circuit breaker to the Off position, insert a flat-blade screwdriver or similar tool into the slot on the breaker as shown in the following figure. To reset the breaker, press the end nearest ON until it clicks into place.

Figure 4.17 Manually Changing a Circuit Breaker State

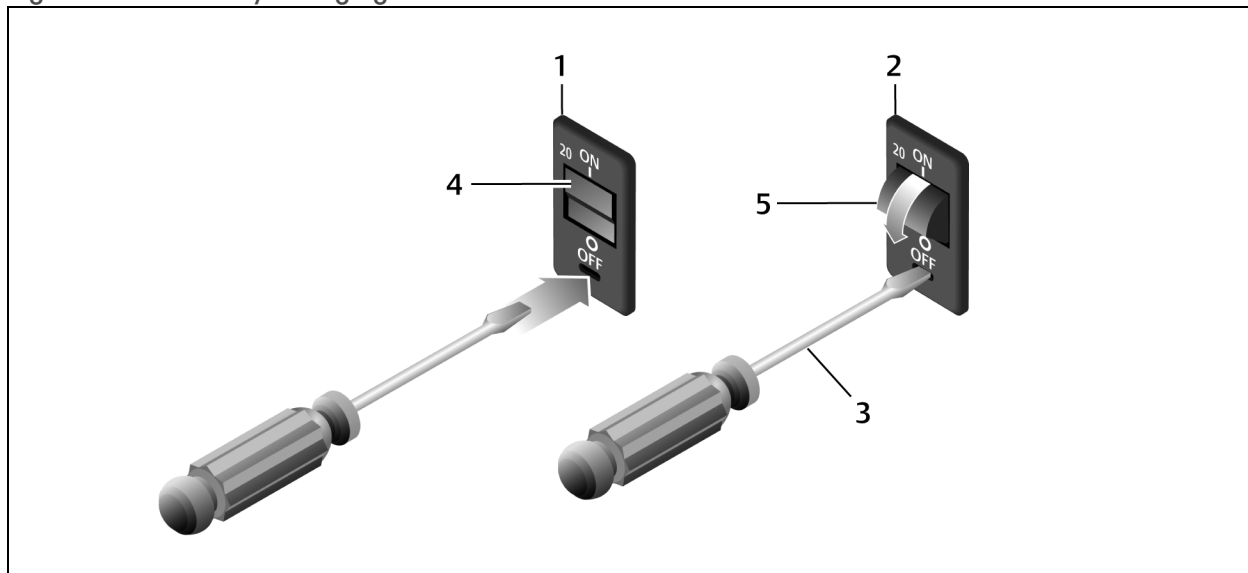

Table 4.2 Manually Changing a Circuit Breaker

#### State Descriptions

NUMBER	DESCRIPTION
1	Low-profile breaker switch
2	Standard-profile breaker switch
3	Flat-blade screw driver. To trip breaker (low- or standard-profile), press screw



NUMBER	DESCRIPTION
	driver into slot.
4	Press here to reset low-profile breaker.
5	Push top of breaker switch in to reset standard-profile breaker.

This page intentionally left blank.

# APPENDICES

## Appendix A: Specifications

Table A.1 MPH2 Rack PDU Specifications

	0U	1U	2U
Input Power Configurations; vary by model and region			
Single-Phase Input; CE-Mark			
240 VAC, 16 A; also UL-listed		3.8 kW	
230 V, 32 A		7.3 kW	
Three-phase Input; CE-Mark			
230/400 V, 16 A		11 kW	
230/400 V, 32 A		22 kW	
Single-Phase Input, UL-Listed			
120 VAC, 12A		1.4 kW	
120 VAC, 16 A		1.9 kW	
120 VAC, 24 A		2.8 kW	
208 VAC, 24 A		4.9 kW	
Three-Phase Input; UL-Listed			
120/208 VAC, 24 A		8.6 kW	
120/208 VAC, 40 A		14.4 kW	
120/208 VAC, 48 A 240/415 VAC, 24 A		17.2 kW	
Input Wiring Options	10-ft (3-m) non-detachable power supply cord. Hard-wired terminal block for connection of field wiring		
Receptacle Options	NEMA 5-20; IEC 320C13; IEC 320C19		
Maximum Number of Receptacles	48	12	24
Maximum Power Consumption	6 W		
Measurement Accuracy	Voltage - +/- 1% +0.1 VAC Current - +/- 1.5% +0.01 A from 1% to 10% of unit rating +/- 1% +0.01 A from >10% to 125% of unit rating		
Insulation	Class I reinforced SELV		
Dielectric Electric Strength	Tested up to 4242 VDC		
Overcurrent Protection	UL489-Listed, CSA, TUV, CCC hydraulic-magnetic circuit breaker, 20 A, 5000 A, A.I.C		
Operating Temperature Range	32 A or less input models: 41° F to 140° F (5° C to 60° C) 40 A and 48 A input models without case ventilation: 41° F to 122° F (5° C to 50° C) 40 A and 48 A input models with case ventilation: 41° F to 140° F (5° C to 60° C)		
Storage Temperature Range	-4° F to 185° F (-20° C to 85° C)		
Humidity %	10% to 90% non-condensing		
Altitude ft (m)	6562 ft (2000 m)		
Mounting	Factory-installed tool-less brackets Universal mounting bracket	Factory installed, right-angle mounting brackets	
Width x Depth Inches (mm)	Low-profile: 2.2 x 1.96 (56 x 50) Standard: 2.2 x 2.7 (56 x 69)	1.73 x 9.84 (44 x 250)	3.46 x 9.84 (88 x 250)

	0U	1U	2U
Length in (mm)	13.1 - 72.2 (333-1833)	19 (483)	
Safety Standards (vary by model and region)	IEC 60950-1:2006/A2:2013 (second edition + amendment2:2013) CSA 22.2 No. 60950-1-07 (second edition) + amendment 1:2011-2012 UL 60950-1 (second edition, 2011-12-19) IECEE CB Full Certificate Scheme (IEC 60950-1:2005(ed.2) + A1:2009 + A2:2013)		
EMC Standards (vary by region)	FCC Class A, Part 15, Industrial EN55022:2006+A1:2007, Class A, Industrial EN55024:1998+A1:2001+A2:2003, Class A, Industrial IEC61000-3-2:2014 (edition 3), IEC61000-3-3:2013 (edition 3) IEC61000-4-2/3/4/5/6/8/11 Note: A temporary loss of touch-key functionality may occur for sufficiently large radio-frequency fields induced through the input power-supply cord.		
Agency Approvals (vary by model and region)	UL, cUL, CE, BV, CB, RoHS, REACH, WEEE		

## Appendix B: Troubleshooting

NOTE: Per UL 60950-1 2nd Ed. ITE safety-standard requirements, the current ratings of UL Listed models are 80% of input-plug, branch-circuit-breaker and receptacle maximum current ratings.

Table B.1 Receptacle LED Troubleshooting

LED INDICATION (ONE OR ALL LEDES)		AUDIBLE ALARM	CONDITION	STATUS/RECOMMENDED ACTION
COLOR	STATE/ FLASH SPEED			
Green	Steady On	—	Input-voltage-supported Receptacle Powered-on	Normal Operation
Green	Fast	—	Receptacle Identification	Remote user is requesting receptacle identification. The LED should stop flashing after 10 seconds.
Off	NA	—	Voltage Off	Check receptacle power control settings.
Green	Slow	—	Overcurrent Warning	Check for changing load conditions. Check overcurrent warning threshold settings.
Red	Fast	✓	Overcurrent Alarm	Check for changing load conditions. Check overcurrent alarm threshold settings.
			Undercurrent Alarm	Check for removal of load. Check undercurrent alarm threshold settings.
Red (All LEDs)	Pulse	—	Branch Circuit Breaker Open	Check for changing load conditions; confirm circuit breaker actuator is closed. If open, correct loading condition before pressing circuit breaker actuator closed again. NOTE: On single-phase, switched-receptacle models, this may indicate that the input-power line and neutral are swapped.
Green (All LEDs)	Slow	—	Branch Overcurrent Warning	Check for changing load conditions. Check overcurrent warning threshold settings.
Red (All LEDs)	Fast	✓	Branch Overcurrent Alarm	Check for changing load conditions. Check overcurrent alarm threshold settings.

**Table B.2 Line LED Troubleshooting**

LED INDICATION (ONE OR ALL LEDES)		AUDIBLE ALARM	CONDITION	STATUS/RECOMMENDED ACTION
COLOR	STATE/ FLASH SPEED			
Green	Steady On	—	None	Normal Operation Note: Depending on plug type, not all LEDs may be lit, see <a href="#">Additional Troubleshooting by Plug Type</a> on page 43.
Off	NA	—	Voltage Off	Confirm that the LED is active per <a href="#">Additional Troubleshooting by Plug Type</a> on page 43. Check power source and input plug's receptacle wiring. Check receptacle power control settings.
Red	Steady On	✓	Line Undervoltage Alarm	Check power source for power quality problem. If the MPH2™ Rack PDU uses 3-phase power, a single low-voltage phase may cause one or more undervoltage alarms. The undervoltage alarm is factory-set to -10% of the minimum input voltage range on the nameplate; it cannot be changed.
Red	Fast	✓	Overcurrent Alarm Undercurrent Alarm	Check for changing load conditions. Check overcurrent alarm threshold settings. Check for removal of load. Check undercurrent alarm threshold settings.
Green	Slow	—	Overcurrent Warning	Check for changing load conditions. Check overcurrent warning threshold settings.
Green/Red	Fast	—	Firmware Update	Firmware update in-progress. LCD does not display information. If the update fails or aborts, the indication continues until firmware update is tried again and is successful.

## Appendix C: Additional Troubleshooting by Plug Type

The following table describes the line LEDs active by plug type. Depending on the type of plug, not all of the line LEDs may be lit. The table also describes the branch circuits/receptacle-type and corresponding input-power voltage phases.

**Table C.1 Active Line LEDs and Branch Voltage Phasing by Plug Type**

PLUG TYPE	POLE/WIRE CONFIG.	RECEPTACLE TYPES		LEDS ACTIVE			BRANCH VOLTAGE PHASING						
		NEMA 5-20	IEC C13/C19	L1	L2	L3	A	B	C	D	E	F	
NEMA 5-15P	1P3W	✓		✓			L1-N						
NEMA 5-20P	1P3W	✓		✓			L1-N						
NEMA L5-20P	1P3W	✓		✓			L1-N						
NEMA L5-30P	1P3W	✓		✓			L1-N	L1-N					
NEMA L6-20P	2P3W		✓	✓	✓		L1-L2						
NEMA L6-30P	2P3W		✓	✓	✓		L1-L2	L1-L2					
NEMA L14-30P	2P4W	✓	✓	✓	✓		L1-N	L1-L2	L1-L2				
NEMA L15-20P	3P4W		✓	✓	✓	✓	L1-L2	L2-L3	L3-L1				
NEMA L15-30P	3P4W		✓	✓	✓	✓	L1-L2	L2-L3	L3-L1				
NEMA L21-20P	3P5W		✓	✓	✓	✓	L1-L2	L2-L3	L3-L1				
	3P5W	✓	✓	✓	✓	✓	L1-N + L1-L2	L2-N + L2-L3	L3-N + L3-L1				
NEMA L21-30P	3P5W		✓	✓	✓	✓	L1-L2	L2-L3	L3-L1				
	3P5W	✓			✓	✓	L1-N	L2-L3	L2-L3				
	3P5W	✓	✓	✓	✓	✓	L1-N + L1-L2	L2-N + L2-L3	L3-N + L3-L1				
NEMA L22-30P	3P5W		✓	✓	✓	✓	L1-N	L2-N	L3-N	L1-N	L2-N	L3-N	
CS8365C 50A	3P4W		✓	✓	✓	✓	L1-L2	L2-L3	L3-L1	L1-L2	L2-L3	L3-L1	
IEC 60309 1P3W 16A	1P3W		✓	✓			L1-N						
IEC 60309 1P3W 32A	1P3W		✓	✓			L1-N	L1-N					
IEC 60309 3P5W 16A	3P5W		✓	✓	✓	✓	L1-N	L2-N	L3-N				
IEC 60309 3P5W 32A	3P5W		✓	✓	✓	✓	L1-N	L2-N	L3-N	L1-N	L2-N	L3-N	
IEC 60309 3P4W 60A	3P4W		✓	✓	✓	✓	L1-L2	L2-L3	L3-L1	L1-L2	L2-L3	L3-L1	

This page intentionally left blank.







---

VertivCo.com | Vertiv Headquarters, 1050 Dearborn Drive, Columbus, OH, 43085, USA

© 2017 Vertiv Co. All rights reserved. Vertiv and the Vertiv logo are trademarks or registered trademarks of Vertiv Co. All other names and logos referred to are trade names, trademarks or registered trademarks of their respective owners. While every precaution has been taken to ensure accuracy and completeness herein, Vertiv Co. assumes no responsibility, and disclaims all liability, for damages resulting from use of this information or for any errors or omissions. Specifications are subject to change without notice.

SL-20860\_REV6\_11-17/590-1330-501D