



Liebert® XDP with iCOM™

Indirect Cooling with XD Cooling Modules

50 & 60 Hz, 160kW Nominal Capacity; Model Revision 5 or higher

The information contained in this document is subject to change without notice and may not be suitable for all applications. While every precaution has been taken to ensure the accuracy and completeness of this document, Vertiv assumes no responsibility and disclaims all liability for damages resulting from use of this information or for any errors or omissions.

Vertiv recommends installing a monitored fluid detection system that is wired to activate the automatic closure of field-installed coolant fluid supply and return shut off valves, where applicable, to reduce the amount of coolant fluid leakage and consequential equipment and building damage. Refer to local regulations and building codes relating to the application, installation, and operation of this product. The consulting engineer, installer, and/or end user is responsible for compliance with all applicable laws and regulations relating to the application, installation, and operation of this product.

The products covered by this instruction manual are manufactured and/or sold by Vertiv. This document is the property of Vertiv and contains confidential and proprietary information owned by Vertiv. Any copying, use, or disclosure of it without the written permission of Vertiv is strictly prohibited.

Names of companies and products are trademarks or registered trademarks of the respective companies. Any questions regarding usage of trademark names should be directed to the original manufacturer.

Technical Support Site

If you encounter any installation or operational issues with your product, check the pertinent section of this manual to see if the issue can be resolved by following outlined procedures.

Visit <https://www.vertiv.com/en-us/support/> for additional assistance.

TABLE OF CONTENTS

1 Important Safety Instructions	1
1.1 Model Number Nomenclature	4
2 Product Description	5
2.1 General Product Information	5
2.1.1 Product/System Description	5
2.1.2 Minimum Load	5
2.2 Equipment Inspection	6
2.3 Equipment Handling	6
2.3.1 Handling the Vertiv™ Liebert® XDP While it is on a Skid and Packaged	6
2.3.2 Unpacking the Vertiv™ Liebert® XDP	7
2.3.3 Removing the Unit from the Skid Using a Forklift	7
2.3.4 Removing the Unit from the Skid Using Rigging	8
2.3.5 Moving the Unit Using Piano Jacks	9
2.3.6 Removing the Unit from the Piano Jacks	10
3 Installation	11
3.1 Mechanical Considerations	11
3.1.1 Positioning the Liebert® XDP	11
3.1.2 Placing the Vertiv™ Liebert® XDP on a Floor Stand	13
3.2 Electrical Considerations	15
3.2.1 Connecting High Voltage Cables	17
3.2.2 External Pump Overloads	20
3.2.3 Extra Low Voltage (ELV) Connections	21
3.2.4 DIP Switch and Jumper Settings for Remote Sensors	23
3.3 Field Connections—Optional for All Units	25
3.4 Remote Sensor Installation—Proper Placement	26
4 Piping	27
4.1 Connection Sizes	27
4.1.1 Recommended Pipe Size	27
4.2 Vertiv™ Liebert® XDP Interconnection with Liebert® XD Cooling Modules	28
4.3 Piping Installation Methods	28
4.3.1 Piping Installation—R-134a Pumped Circuit	28
4.3.2 Piping Mains	29
4.3.3 Bypass Flow Controller	29
4.4 Piping Details—Shutoff/Isolation Valves	30
4.4.1 Evacuation and Leak Check—R-134a Pumped Circuit	31
4.4.2 Insulation	31
4.5 Filling the Pumped Circuit—R-134a	32
4.5.1 Calculating Refrigerant Charge—Example	33
4.6 Checklist for Proper Installation	34

- 5 Vertiv™ Liebert® iCOM™ Control—Firmware Version XP1.00.010.STD 35**
- 5.1 Liebert® iCOM™ Components and Functions 35
- 5.2 Display Lamp Indicators 37
- 5.3 Navigating Through the Vertiv™ Liebert® iCOM™ Display 37
 - 5.3.1 Accessing Menus and Settings 38
 - 5.3.2 Cooling Module Overview 39
 - 5.3.3 Entering the Password 39
- 5.4 Changing Vertiv™ Liebert® iCOM™ Display Settings 40
- 5.5 Changing Operational Settings 41
- 5.6 Graphical Data Record 41
- 5.7 Vertiv™ Liebert® iCOM™ User Menu Icons and Legend 42
- 5.8 Vertiv™ Liebert® iCOM™ User Menu Screens 43
- 5.9 Liebert® iCOM™ Service Menu Icons and Legend 51
- 5.10 Vertiv™ Liebert® iCOM™ Service Menu Screens 52
- 6 Start the Vertiv™ Liebert® XDP with Liebert® iCOM™ 73**
- 6.1 Checklist for Liebert® XDP Start-up 73
- 6.2 Starting the Vertiv™ Liebert® XDP with Liebert® iCOM™ Controller 74
- 7 Alarm Descriptions and Solutions 77**
- 7.1 Alarm Descriptions 77
- 7.2 Warning Descriptions 79
- 7.3 System Shutdown Causes 79
- 8 Troubleshooting 81**
- 9 Maintenance 83**
- 10 Specifications 85**
- Appendices 87**
- Appendix A: Technical Support and Contacts 87

1 Important Safety Instructions

SAVE THESE INSTRUCTIONS

This manual contains important safety instructions that should be followed during the installation and maintenance of the Liebert® XDP. Read this manual thoroughly before attempting to install or operate this unit.

Only qualified personnel should move, install or service this equipment.

Adhere to all warnings, cautions, notices and installation, operating and safety instructions on the unit and in this manual. Follow all operating and user instructions.

Follow all local codes.



WARNING! Arc flash and electric shock hazard. Can cause serious injury or death. Building and equipment damage may also result. Disconnect all local and remote electric power supplies and wear appropriate, OSHA-approved personal protective equipment (PPE) per NFPA 70E before working within the electric control enclosure. Customer must provide earth ground to unit, per NEC, CEC and local codes, as applicable.

Verify with a voltmeter that power is Off. The Liebert® controller does not isolate power from the unit, even in the “Unit Off” mode. Some internal components still require and receive power even during the “Unit Off” mode of the controller. The factory-supplied, optional disconnect switch is inside the unit. The line side of this switch contains live high voltage. The only way to ensure that there is NO voltage inside the unit is to install and open a remote disconnect switch. Refer to unit electrical schematic.

Before proceeding with installation, read all instructions, verify that all the parts are included and check the nameplate to be sure the voltage matches available utility power. Follow all local codes.



WARNING! Risk of improper wiring, piping, moving, lifting and handling. Can cause serious injury or death. Building and equipment damage may also result. Installation and service of this equipment should be done only by qualified personnel who have been specially-trained in the installation of air-conditioning equipment and who are wearing appropriate, OSHA-approved PPE.



WARNING! Risk of top heavy unit falling over when improperly lifted or moved. Can cause serious injury or death. Building and equipment damage may also result. Read all of the following instructions and verify that all lifting and moving equipment is rated for the weight of the unit before attempting to move, lift, remove packaging from or prepare the unit for installation.



CAUTION: Risk of excessive refrigerant line pressure. Can cause equipment damage or injury resulting from tubing and component rupture. Do not close off the refrigerant-line isolation valve for repairs unless a pressure-relief valve is field-installed in the line between the isolation valve and the check valve. The pressure-relief valve must be rated 5% to 10% higher than the system-design pressure. An increase in ambient temperature can cause the pressure of the isolated refrigerant to rise and exceed the system-design pressure rating (marked on the unit nameplate).



CAUTION: Risk of contact with hot surfaces. Can cause injury. Personal burn injury can be the result of touching an electronics housing, fan motor, and some electrical components that are extremely hot during unit operation. Allow sufficient time for them to cool to a touch-safe temperature before working within the unit cabinet.

Use extreme caution and wear appropriate, OSHA-approved PPE when working on or near hot components, including when replacing or performing maintenance on the fans.



CAUTION: Risk of contact with sharp edges, splinters and exposed fasteners. Can cause injury. Only properly trained and qualified personnel wearing appropriate, OSHA-approved PPE should attempt to move, lift, remove packaging from or prepare the unit for installation.



CAUTION: Risk of improper handling heavy and lengthy parts. Can cause injury. Building and equipment damage may also result. Cabinet panels can exceed 5 ft. (1.5 m) in length and weigh more than 35 lb (15.9 kg). Follow relevant OSHA lifting recommendations and consider using a two-person lift for safe and comfortable removal and installation of cabinet panels. Only properly trained and qualified personnel wearing appropriate, OSHA-approved PPE should attempt to remove or install cabinet panels.



CAUTION: Risk of heavy unit falling into defective raised floor. Can cause injury and equipment damage. Prior to installation, all floor tiles immediately around floor stand are to be removed and inspected. Make sure tiles are not cracked, and ribs have not been cut. If free from defects, re-install. Replace with new tiles if defects are found.



CAUTION: Risk of improper piping installation, leak checking, fluid chemistry and fluid maintenance. Can cause injury. Building and equipment damage may also result. Installation and service of this equipment should be done only by qualified personnel who have been specially-trained in the installation of air-conditioning equipment and who are wearing appropriate, OSHA-approved PPE.

NOTICE

Risk of clogged or leaking drain lines and leaking water supply lines. Can cause equipment and building damage.

Can cause equipment and building damage.

Lines and joints must be inspected regularly. Improper installation, application and service practices can result in water leakage from the unit. Water leakage can result in severe property damage and loss of critical data center equipment. Do not locate unit directly above any equipment that could sustain water damage.

Vertiv recommends installing monitored leak detection equipment for the unit and supply and return lines.

NOTICE

Risk of clogged or leaking drain lines and leaking water supply lines. Can cause equipment and building damage.

Can cause equipment and building damage.

Lines and joints must be inspected regularly. Improper installation, application and service practices can result in water leakage from the unit. Water leakage can result in severe property damage and loss of critical data center equipment. Do not locate unit directly above any equipment that could sustain water damage.

Vertiv recommends installing monitored leak detection equipment for the unit and supply and return lines.

NOTICE

Risk of piping system corrosion and freezing fluids. Can cause leaks resulting in equipment and very expensive building damage. Heat exchangers and piping systems are at high risk of freezing and premature corrosion. Fluids in these systems must contain the proper antifreeze and inhibitors to prevent freezing and premature coil and piping corrosion. When the cooling unit or piping may be exposed to freezing temperatures, charge the system with coolant fluid based on the coldest ambient design temperature. Automotive antifreeze is unacceptable and must NOT be used in any fluid system. Use only coolant fluid solution that meets the requirements of recommended industry practices. Do not use galvanized pipe.

The system coolant fluid must be analyzed by a competent fluid treatment specialist before start up to establish the inhibitor and antifreeze solution requirement and evaluated at regularly scheduled intervals throughout the life of the system to determine the pattern of inhibitor depletion.

The fluid complexity and variants of required treatment programs make it extremely important to obtain the advice of a competent and experienced fluid treatment specialist and follow a regularly scheduled coolant-fluid system-maintenance program.

Fluid chemistry varies greatly as do the required additives, called inhibitors, that reduce the corrosive effect of the fluids on the piping systems and components.

The chemistry of the coolant fluid used must be considered, because some sources may contain corrosive elements that reduce the effectiveness of the inhibited formulation. Sediment deposits prevent the formation of a protective oxide layer on the inside of the coolant system components and piping. The coolant fluid must be treated and circulating through the system continuously to prevent the buildup of deposits and/or growth of sulfate reducing bacteria. Proper inhibitor maintenance must be performed to prevent corrosion of the system.

Consult fluid manufacturer for testing and maintenance of inhibitors.

Commercial-grade coolant fluid is generally less corrosive to the common metals of construction than water itself. It will, however, assume the corrosivity of the coolant fluid from which it is prepared and may become increasingly corrosive with use if not properly inhibited.

Vertiv recommends installing a monitored fluid-detection system that is wired to activate the automatic closure of field-installed coolant fluid supply and return shut-off valves to reduce the amount of coolant fluid leakage and consequential equipment and building damage. The shut-off valves must be sized to close-off against the maximum coolant-fluid system pressure in case of a catastrophic fluid leak.

NOTICE

Risk of no flow condition. Can cause equipment damage. Do not leave the water/coolant fluid supply circuit in a no flow condition. Idle fluid allows the collection of sediment that prevents the formation of a protective oxide layer on the inside of the tubes. Keep unit switched On and water/ coolant fluid supply circuit system operating continuously. In multiple unit teams, allow standby units to enter the rotation automatically or schedule regular manual rotations.

NOTICE

Risk of passageway interference. Can cause unit and/or structure damage. The unit may be too large to fit through a passageway while on or off the skid. Measure the unit and passageway dimensions, and refer to the installation plans prior to moving the unit to verify clearances.

NOTICE

Risk of damage from forklift. Can cause unit damage. Keep tines of the forklift level and at a height suitable to fit below the skid and/or unit to prevent exterior and/or underside damage.

NOTICE

Risk of improper storage. Can cause unit damage.

Keep the unit upright, indoors and protected from dampness, freezing temperatures and contact damage.

NOTE: This document is intended to be used together with site specific documentation and documentation for other parts of the system (heat rejection devices and cooling modules).

NOTE: Before any action that could cause a disturbance in the Liebert® XD system's cooling function is begun, the facility manager **MUST** be informed. In addition, after the action is taken and the work is finished, the facility manager **MUST** be informed.

1.1 Model Number Nomenclature

Figure 1.1 Model Number Nomenclature

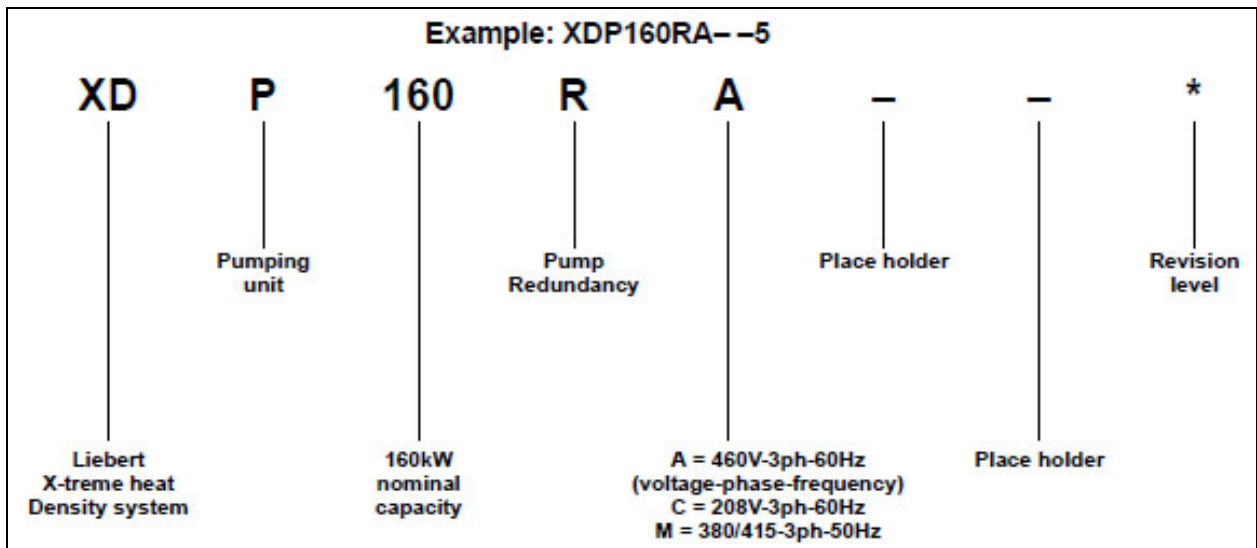

2 Product Description

2.1 General Product Information

2.1.1 Product/System Description

Vertiv™ Liebert®'s XDP refrigerant distribution unit is an interface between the building chilled water system and the cooling modules in the Liebert® XD system. It is designed to circulate and control refrigerant to the cooling modules that are in the room with heat-producing equipment. The Liebert® XDP is rated for 160kW (546,000BTU/H) of cooling.

The Liebert® XDP consists of a cabinet that includes a heat exchanger, circulating pump(s), control valve, receiver, controls, valves and piping.

The Liebert® XDP monitors room conditions and prevents coil condensation by maintaining the refrigerant being pumped to the cooling modules at a temperature above the room's dew point.

All functions, such as switching pumps (if applicable), controlling refrigerant temperature, etc., are automatic.

Figure 2.1 Liebert® XDP Components

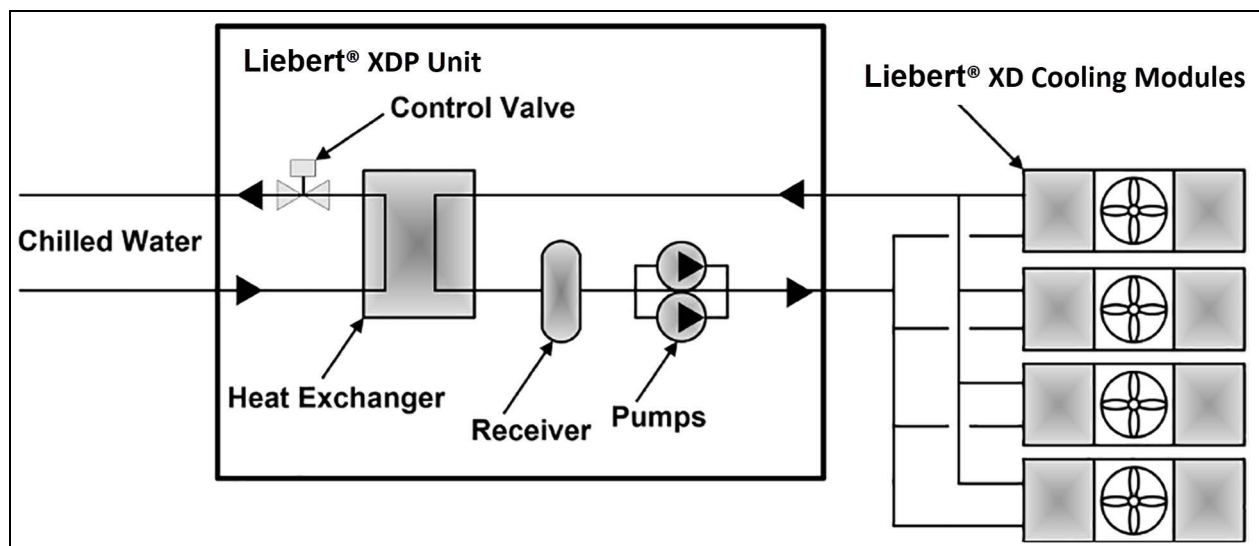

NOTE: Liebert® XDP does not support Teamwork Mode or Standby - Lead/Lag operation.

2.1.2 Minimum Load

The Vertiv™ Liebert® XDP's minimum recommended operating load is 30% of system nominal capacity. The Liebert® XDP160 is rated for 160kW (546,000BTU/H) of cooling, therefore the system's minimum recommended load is 48kW (163,800BTU/H). Loading below this value can unfavorably affect system operation. Consult the factory for any loading below this recommendation.

To achieve the minimum recommended load, the capacity of all connected modules must total at least 48kW (163,800BTU/H). See the following table.

Table 2.1 Number of Liebert® XD Cooling Modules Required to Achieve at Least 48kW (163,800 BTU/H) Load

	XD Module Type		
	XDV10	XDO20	XDH32
Number of Liebert® XD cooling modules required to achieve at least 48kW (163,800BTU/H) load	5	3	3

2.2 Equipment Inspection

When the unit is delivered, inspect all items for visible and concealed damage. Damage should be immediately reported to the carrier and a damage claim filed with a copy sent to Vertiv and to your sales representative.

2.3 Equipment Handling



WARNING! Risk of top heavy unit falling over when improperly lifted or moved. Can cause serious injury or death. Building and equipment damage may also result. Read all of the following instructions and verify that all lifting and moving equipment is rated for the weight of the unit before attempting to move, lift, remove packaging from or prepare the unit for installation.



CAUTION: Risk of contact with sharp edges, splinters and exposed fasteners. Can cause injury. Only properly trained and qualified personnel wearing appropriate, OSHA-approved PPE should attempt to move, lift, remove packaging from or prepare the unit for installation.

2.3.1 Handling the Vertiv™ Liebert® XDP While it is on a Skid and Packaged

- Always keep the unit upright, indoors and protected from damage.
- If possible, transport the unit using a forklift truck. Otherwise use a crane with belts or cables. In either case, do NOT press on the top edges of the packaging.
- If using a forklift, make sure the forks (if adjustable) are spread to the widest allowable distance to still fit under the skid.
- When moving the skidded unit with a forklift truck, do not lift the unit any higher than 6" (152mm). If circumstances require the unit to be lifted higher than 6" (152mm), great care must be exercised and all by-standing personnel are to be no closer than 20 feet (6m) from the lift point of the unit.

NOTICE

Risk of structural interference. Can cause equipment or building damage.

While on the skid, the unit is too tall (83" [2108mm] overall height) to fit through a standard doorway. Any attempt to move the unit, while skidded, through a standard doorway will cause damage to the unit and to the building.

NOTICE

Risk of damage from forklift. Can cause unit damage.

Keep tines of the forklift level and at a height suitable to fit below the skid and/or unit to prevent exterior and/or underside damage.

NOTICE

Risk of improper storage. Can cause unit damage.

Keep the Liebert® XDP upright, indoors and protected from dampness, freezing temperatures and contact damage.

NOTICE

Risk of overtightening securing straps. Can cause damage to panels.

Place a protective material between the straps of the piano jacks and the unit. Ensure that the straps are not tightened to a point of damaging panels.

2.3.2 Unpacking the Vertiv™ Liebert® XDP

1. Remove the exterior stretch wrap packaging from the unit, exposing the protective corner and side packaging planks.
2. Remove and set aside filter dryer kit.
3. Remove the corner and side packaging planks from the unit, exposing the bag over the unit. The bag may remain in place for dust and panel protection or removed for immediate unit installation.
4. Remove the bag from the unit when ready to remove the skid for installation.

Figure 2.2 Unpacking the Liebert® XDP

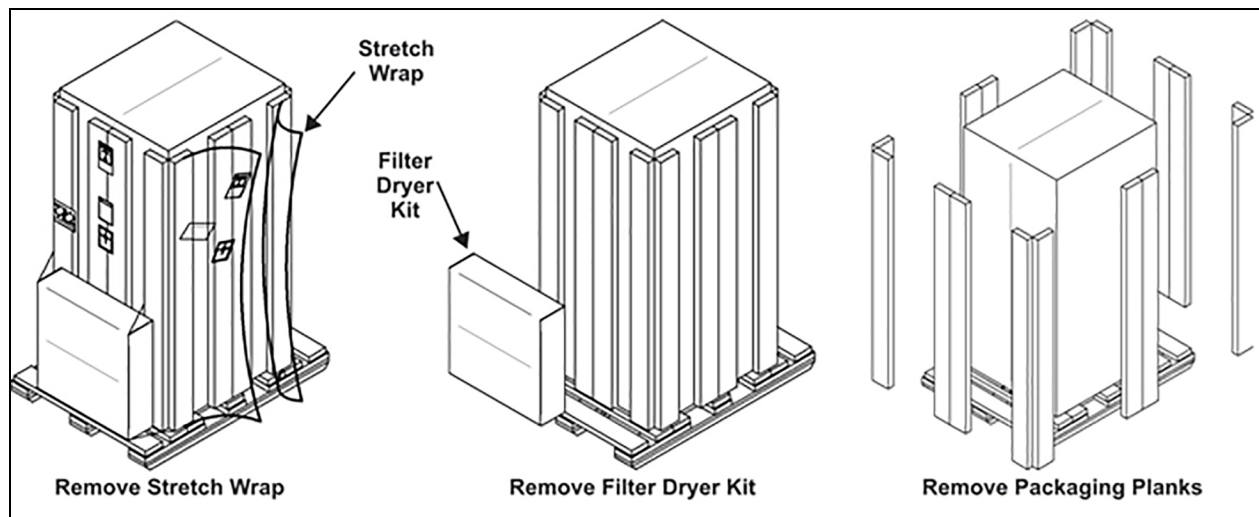
**2.3.3 Removing the Unit from the Skid Using a Forklift**

1. Align the forklift with either the front or rear side of the unit.

Make sure the tines of the forklift are locked to the widest position.

Use the center of gravity indicators to determine the entry points for the tines. The tines must be equally spaced on either side of the center of gravity indicator.

2. Insert the tines of the forklift under the unit.

Make sure the tines are level. The tines must be low enough to fit under the unit without damaging it.

Make sure the tines extend beyond the opposite side of the unit.

3. Remove the 12 lag bolts and two brackets that secure the unit to the skid.

NOTE: Each lag bolt is 1-1/2" (38mm) long. They can be removed with a 9/16" socket or wrench.

4. Lift the unit to a height that it is not being support by the skid.
5. Move the skid from under the unit.

Figure 2.3 Use a Forklift to Remove the Vertiv™ Liebert® XDP From the Skid

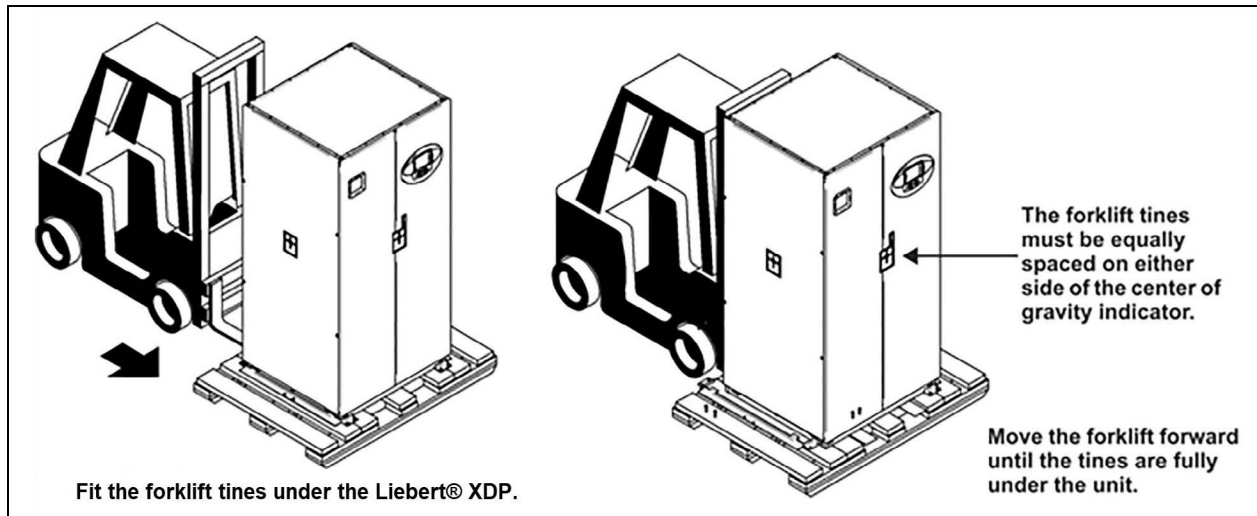

2.3.4 Removing the Unit from the Skid Using Rigging

1. Use the center of gravity indicators on the unit to position the slings. The slings must be equally spaced on either side of the center of gravity indicator. Refer to **Figure 2.4** on the facing page.
2. Place slings under the unit using spaces provided between the skid deck boards.

NOTE: Unit is shown without outer packaging. These instructions may be applied with the outer packaging in place

3. Use spreader bars or an equivalent method to ensure proper protection of the unit.
4. Ensure that the panels, if attached, are well protected from the slings.

NOTE: If rigging is to be used to move the unit closer to the site for installation, place one or two horizontal straps around the unit and vertical straps at mid-height.

5. Remove the 12 lag bolts and two brackets that secure the unit to the skid.

NOTE: Each lag bolt is 1-1/2" (38mm) long. They can be removed with a 9/16" socket or wrench.

6. Lift the unit off of the skid to an elevation point where the skid is not supporting the weight of the unit.
7. Remove the skid from under the unit.

Figure 2.4 Removing the Unit from the Skid Using Rigging

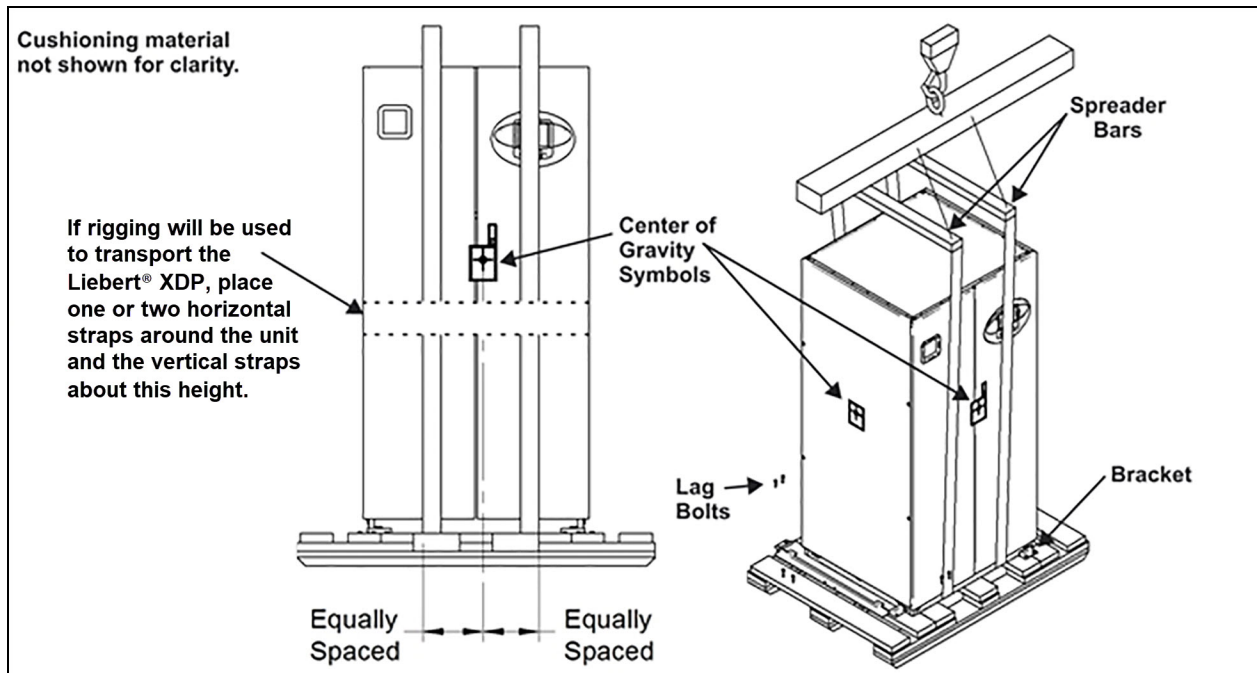

2.3.5 Moving the Unit Using Piano Jacks

1. Elevate the Vertiv™ Liebert® XDP with a lifting mechanism, such as a forklift or rigging.
1. Position one piano jack at each end of the Liebert® XDP.
2. Lower the unit to a height suitable for placing it on the piano jacks.
3. Put protective material between the Liebert® XDP and the piano jacks and straps.
4. Secure the Liebert® XDP to the piano jacks.
5. Release the Liebert® XDP from the straps securing it to the lifting mechanism and move the mechanism away from the unit.

Using the piano jacks, at least two properly trained and qualified personnel can move the unit.

Figure 2.5 Securing the Vertiv™ Liebert® XDP to Piano Jacks

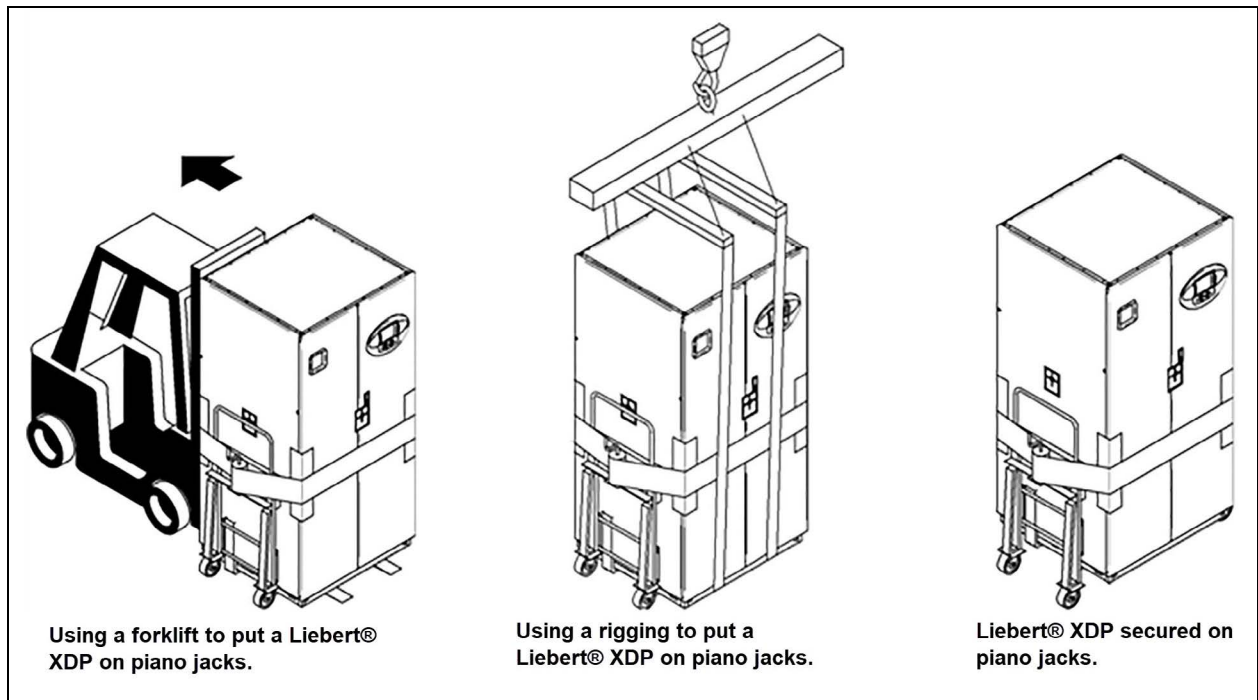

2.3.6 Removing the Unit from the Piano Jacks

1. Lower the Vertiv™ Liebert® XDP as far as the piano jacks will allow.
2. Undo all strapping holding the piano jacks to the unit.
3. Lift one end of the Liebert® XDP off one piano jack with a pry bar or similar device, taking care not to damage the unit's cabinet.
4. Repeat step 3 to remove the piano jack from under the opposite end of the Liebert® XDP.
5. Remove all material used to protect the unit from the piano jacks and strapping.

3 Installation

3.1 Mechanical Considerations

3.1.1 Positioning the Liebert® XDP

Install the Liebert® XDP according to the site specific documentation and secure the unit to the floor.

The Liebert® XDP can be installed near a wall or another Liebert® XDP. However, there must be at least 3 feet (92cm) clearance in front of the Liebert® XDP as service access for components in the unit.

For additional technical information, refer to the System Design and Configuration Document for the Liebert® XD System, SL-16655. The document is available in electronic format at Vertiv's website, www.Vertiv.com, as well as from your local Vertiv representative.

Figure 3.1 Dimensions

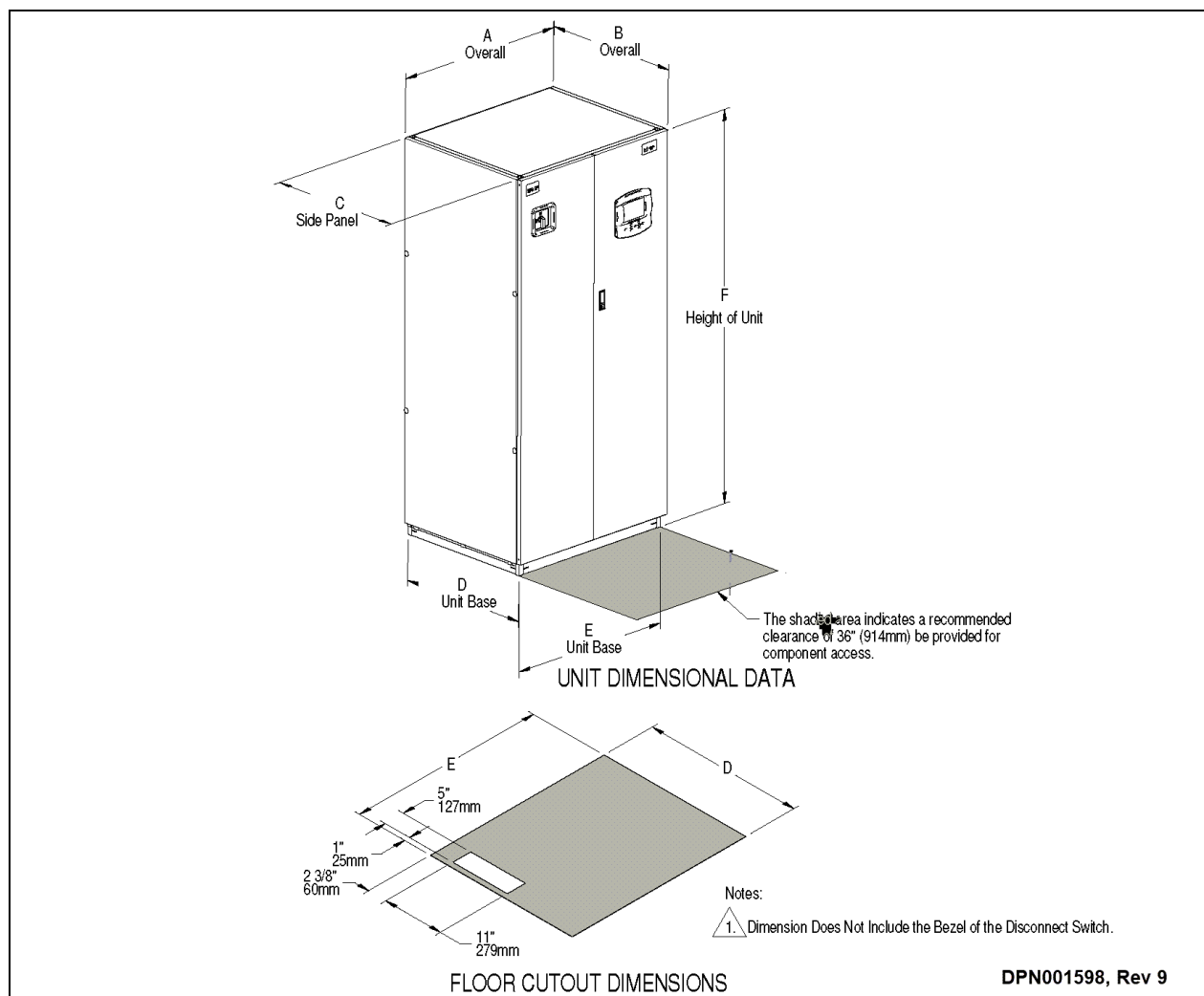

Table 3.1 Liebert® XDP Dimensions

Model	Dimensional Data, inches (mm)						Shipping Weight, lb. (kg)	
	A	B*	C	D	E	H	Domestic	Export
XDP160	38 (965)	34 (864)	33-1/8 (841)	33 (838)	36 (914)	78 (1981)	1020 (462)	1083 (491)

* The dimension does not include the bezel of the disconnect switch.

Source: DPN001958 Rev 9

Figure 3.2 Piping Access Points

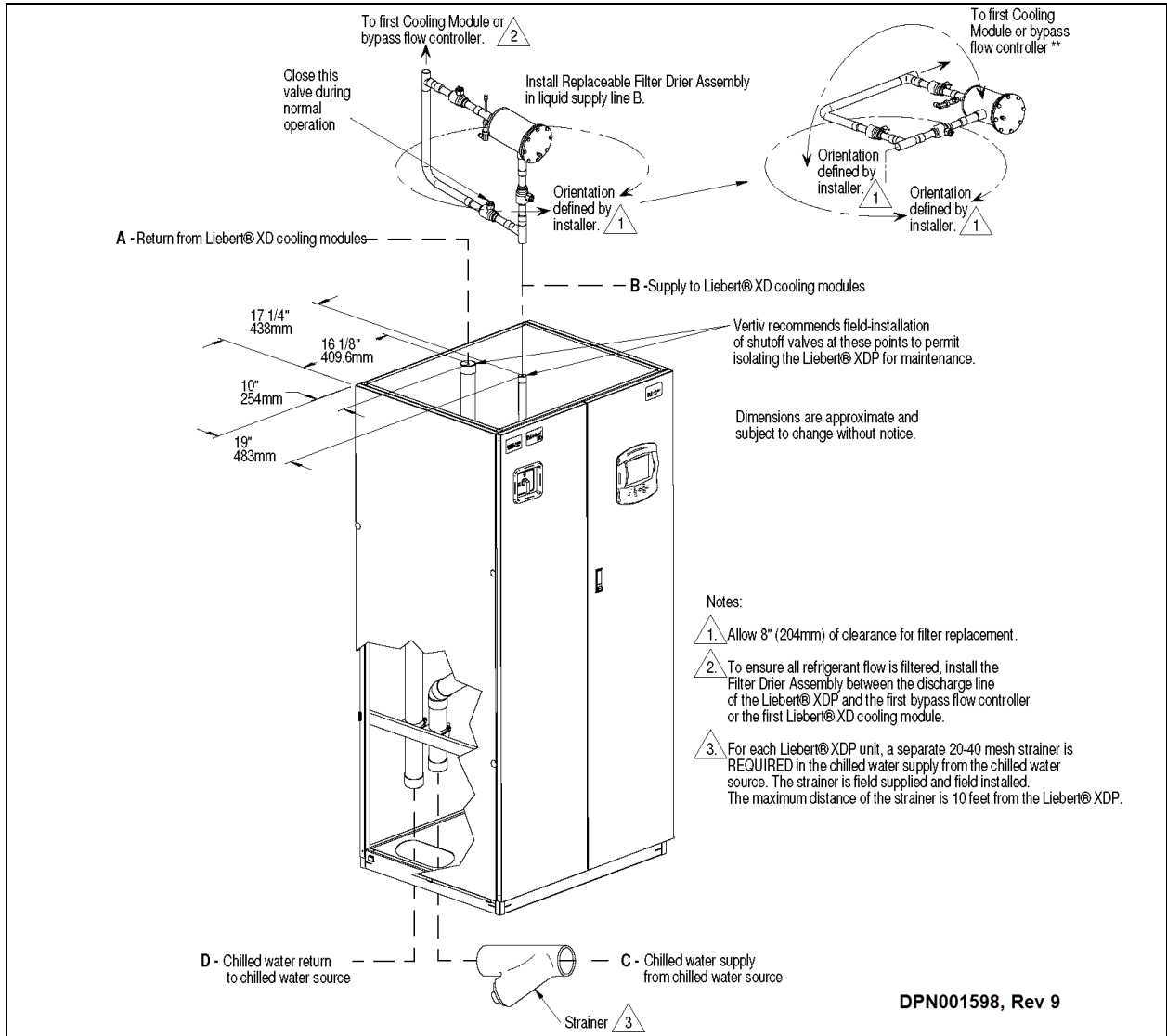

**Table 3.2 Unit Piping Outlet Connection
Sizes, Inches, OD Cu**

Model	Pipe Connection Point			
	A	B	C	D
50/60 Hz				
XDP160	2-1/8	1-1/8	2-5/8	2-5/8

DPN001598, Rev 9

3.1.2 Placing the Vertiv™ Liebert® XDP on a Floor Stand



WARNING! Risk of top heavy unit falling over when improperly lifted or moved. Can cause serious injury or death. Building and equipment damage may also result. Read all of the following instructions and verify that all lifting and moving equipment is rated for the weight of the unit before attempting to move, lift, remove packaging from or prepare the unit for installation.



CAUTION: Risk of heavy unit falling into defective raised floor. Can cause injury and equipment damage. Prior to installation, all floor tiles immediately around floor stand are to be removed and inspected. Make sure tiles are not cracked, and ribs have not been cut. If free from defects, re-install. Replace with new tiles if defects are found.

Unit to be placed onto floor stand using process that will provide safest method based on site layout. Professional installers to be used when placing unit. Unit may require lift onto a floor stand if elevated flooring has not been installed. If flooring is installed, unit will be placed over floor opening containing floor stand.

Figure 3.4 Vertiv™ Liebert® XDP Floorstands 27 — 45 in.

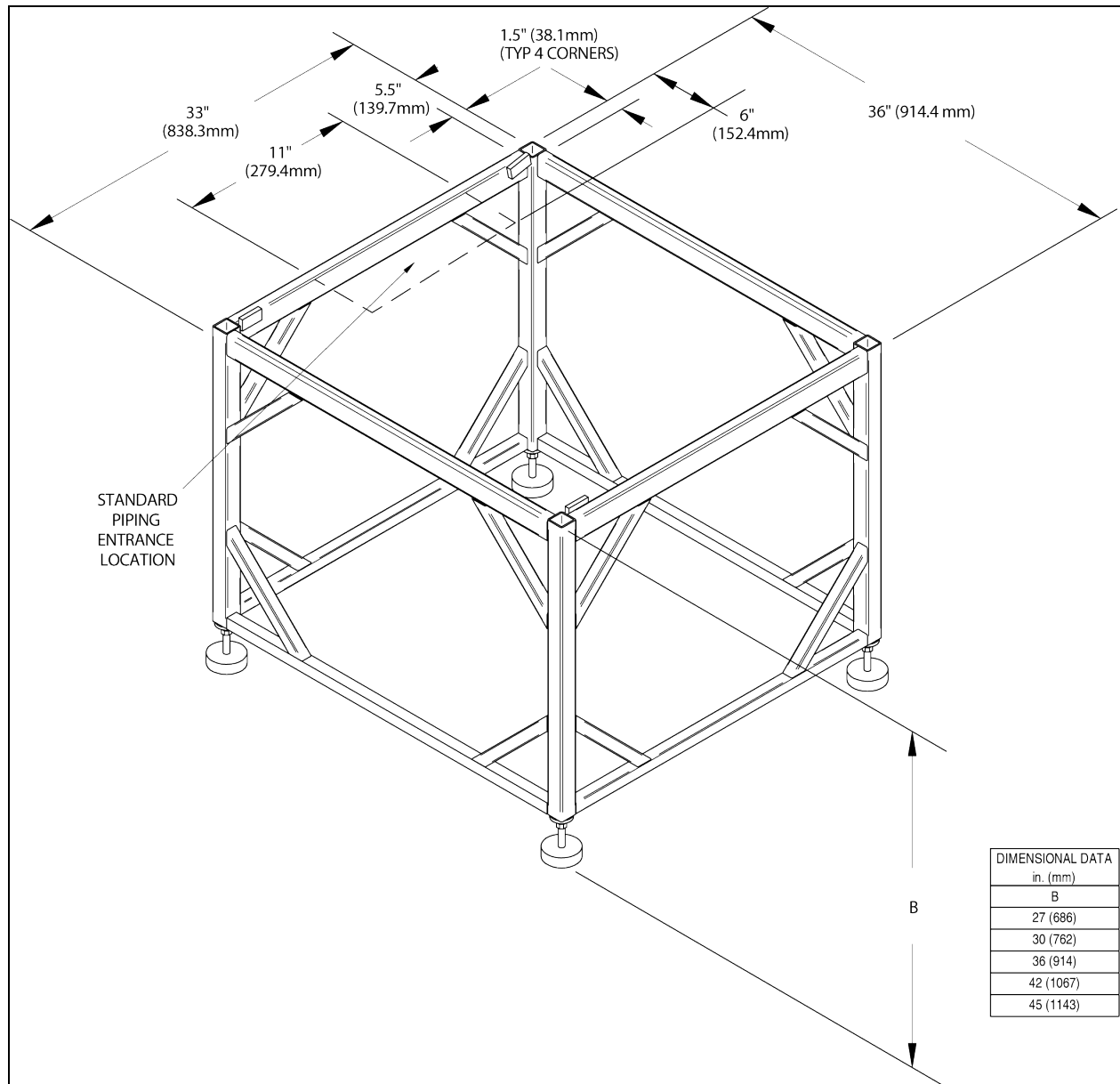

3.2 Electrical Considerations

Make sure the actual supply voltage and frequency correspond to the voltage and frequency indicated on the Vertiv™ Liebert® XDP's rating plate. The unit must be installed in accordance with national wiring regulations.

Connect cables for high voltage supply to the electrical box in the Liebert® XDP according to **Figure 3.7** on page 19 and make sure that the phases are correctly connected.



WARNING! Arc flash and electric shock hazard. Can cause serious injury or death. Building and equipment damage may also result. Disconnect all local and remote electric power supplies and wear appropriate, OSHA-approved personal protective equipment (PPE) per NFPA 70E before working within the electric control enclosure. Customer must provide earth ground to unit, per NEC, CEC and local codes, as applicable.

Verify with a voltmeter that power is Off. The Vertiv™ Liebert® iCOM™ controller does not isolate power from the unit, even in the “Unit Off” mode. Some internal components still require and receive power even during the “Unit Off” mode of the controller. The factory-supplied, optional disconnect switch is inside the unit. The line side of this switch contains live high voltage. The only way to ensure that there is NO voltage inside the unit is to install and open a remote disconnect switch. Refer to unit electrical schematic.

Before proceeding with installation, read all instructions, verify that all the parts are included and check the nameplate to be sure the voltage matches available utility power. Follow all local codes.



WARNING! Risk of short circuits and electric shock. Can cause serious injury or death. Building and equipment damage can result from cut insulation or damaged wires. Can cause overheated wiring, smoke, fire, activation of fire suppression systems and EMS personnel, and loss of power to fans. Verify that all wiring connections are tight and that all wiring is contained within the junction box prior to closing and securing the cover.

The Liebert® iCOM™ controller does not isolate power from the unit, even in the "Unit Off" mode. Some internal components require and receive power even during the "unit off" mode of the Liebert® controller.

Installation, service, and maintenance work must be performed only by properly trained and qualified personnel and in accordance with applicable regulations and manufacturers' specifications. Opening or removing the covers to any equipment may expose personnel to lethal voltages within the unit even when it is apparently not operating and the input wiring is disconnected from the electrical source.



WARNING! Risk of short circuits and electric shock. Can cause serious injury or death. Building and equipment damage can result from cut insulation or damaged wires. Can cause overheated wiring, smoke, fire, activation of fire suppression systems and EMS personnel, and loss of power to fans. Verify that all wiring connections are tight and that all wiring is contained within the junction box prior to closing and securing the cover.

The Liebert® iCOM™ controller does not isolate power from the unit, even in the "Unit Off" mode. Some internal components require and receive power even during the "unit off" mode of the Liebert® iCOM™ controller.

Installation, service, and maintenance work must be performed only by properly trained and qualified personnel and in accordance with applicable regulations and manufacturers' specifications. Opening or removing the covers to any equipment may expose personnel to lethal voltages within the unit even when it is apparently not operating and the input wiring is disconnected from the electrical source.



WARNING! Risk of improper wire sizing/rating and loose electrical connections causing overheated wire and electrical connection terminals resulting in smoke or fire. Can cause serious injury or death. Building and equipment damage may also result. Use correctly sized copper wire only and verify that all electrical connections are tight before turning power On. Check all electrical connections periodically and tighten as necessary.

3.2.1 Connecting High Voltage Cables

1. Turn the Vertiv™ Liebert® XDP's disconnect switch to the OFF position. (See **Figure 3.5** below). Open the front doors and push down on the enclosure cover latch to open the hazardous voltage enclosure cover.

Figure 3.5 Front View of Liebert® XDP and Electrical Enclosure

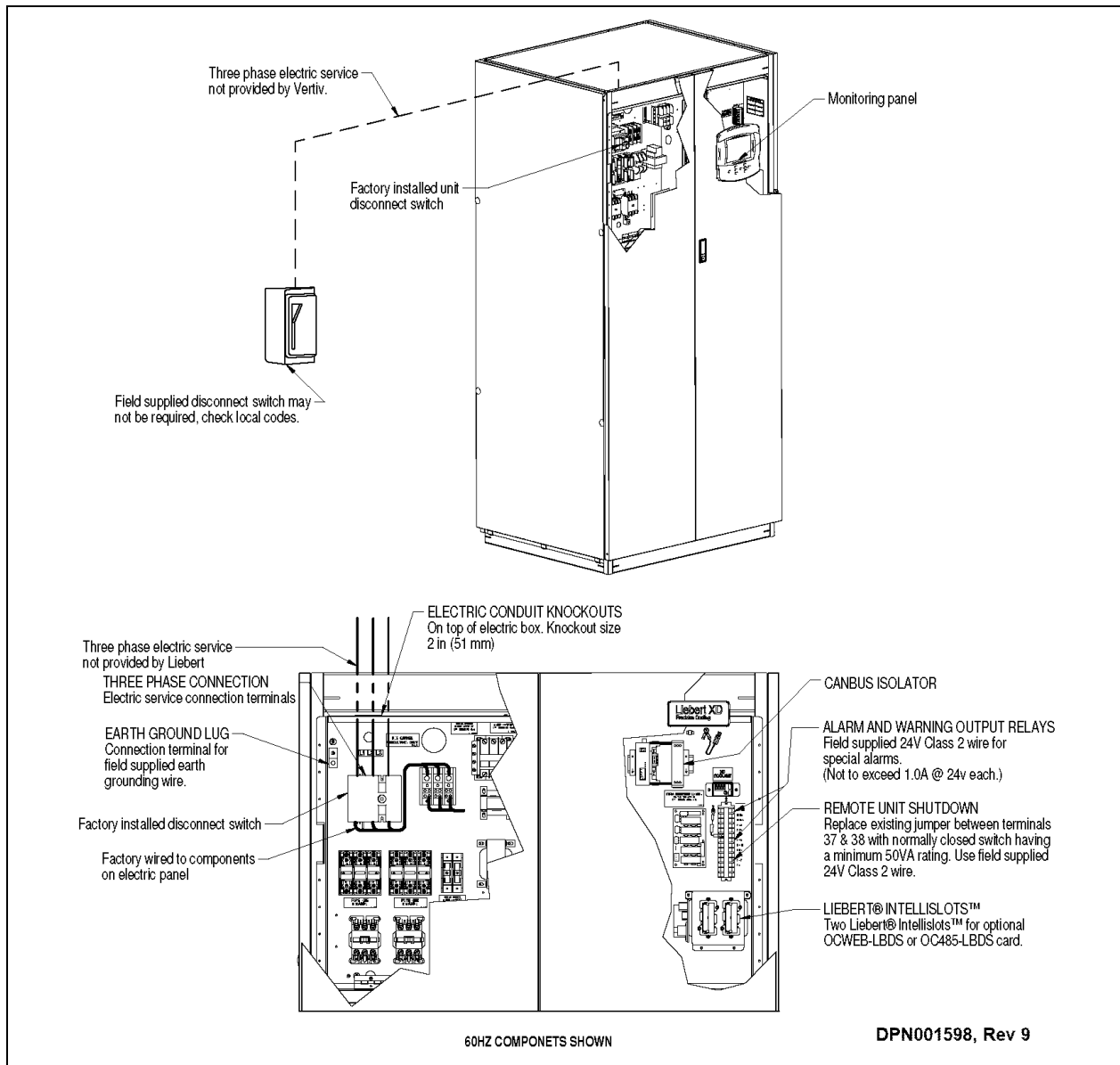

2. Determine which knockouts in the electrical enclosure will be used and remove them. (See **Figure 3.5** above .)

Figure 3.6 Electrical Enclosure Knockout Location for Hazardous Voltage Wiring

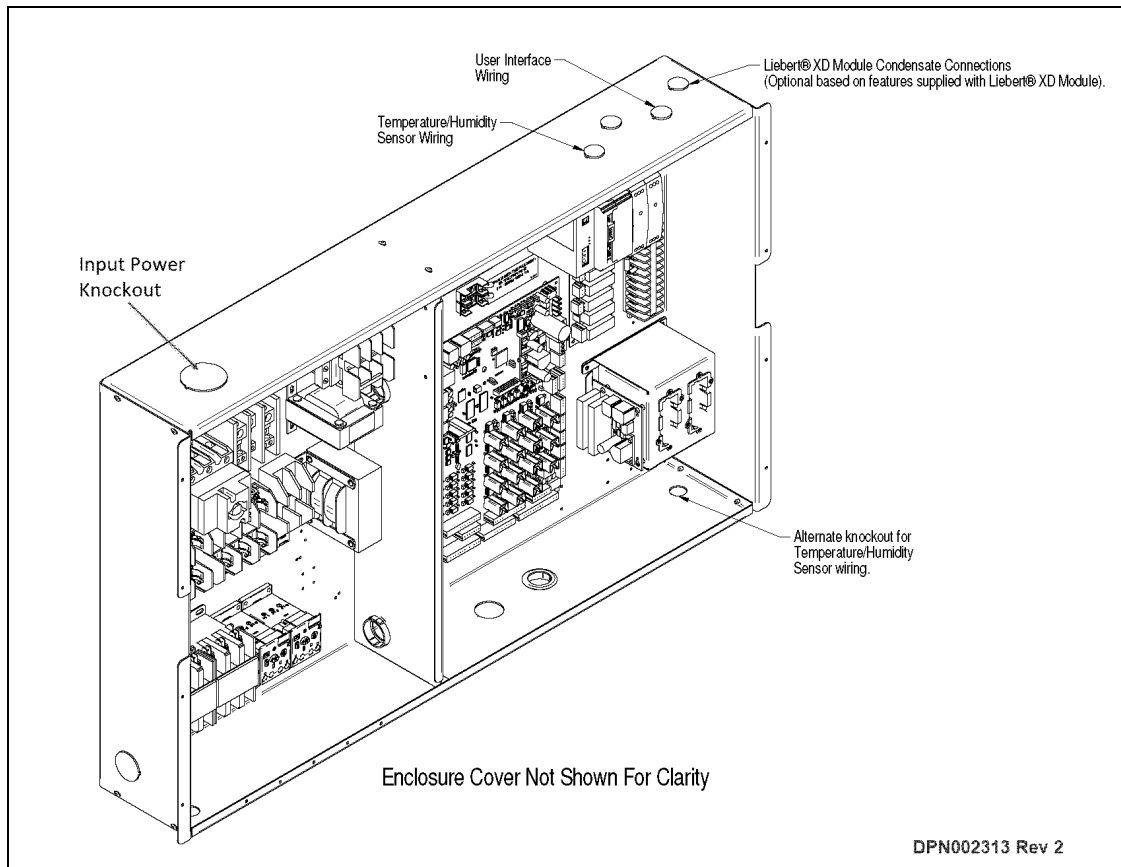

3. Route the input hazardous voltage electrical power wiring through the top left knockout (see **Figure 3.6** above) to the disconnect switch L1, L2 and L3 (see **Figure 3.7** on the facing page and **Figure 3.8** on the facing page). Observe proper phasing.
4. Connect the ground wire to the ground lug (see **Figure 3.7** on the facing page and **Figure 3.8** on the facing page), which is in the middle left of the enclosure.

Figure 3.7 High Voltage Connections—60 Hz

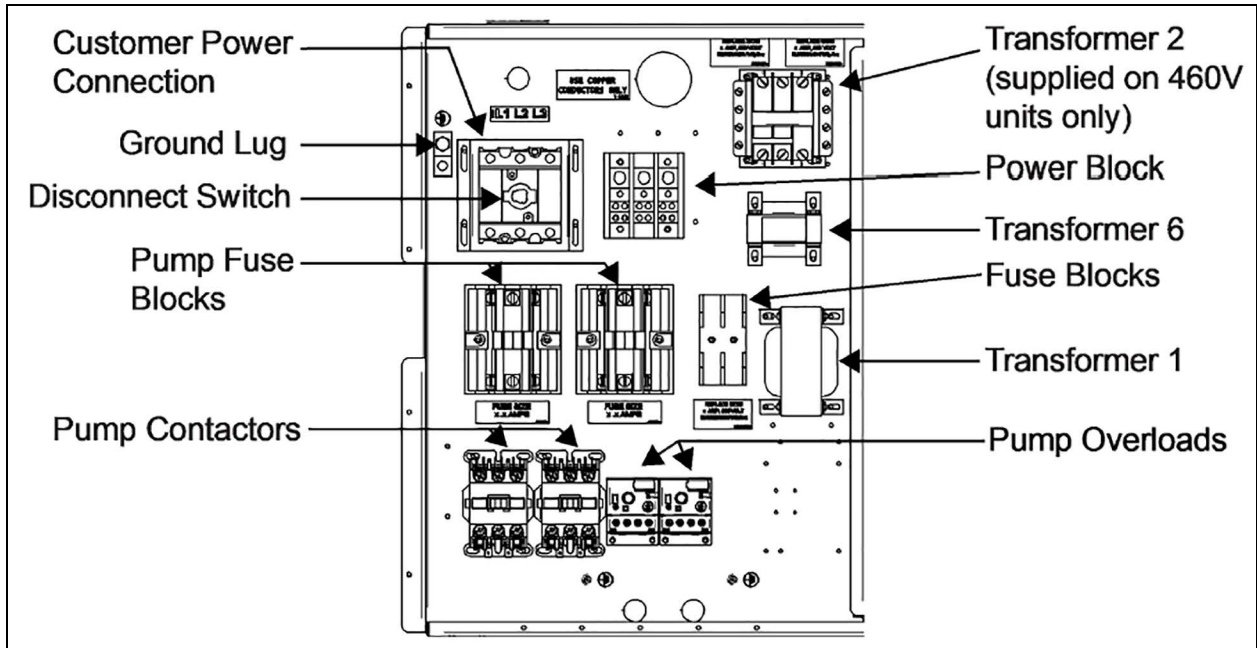
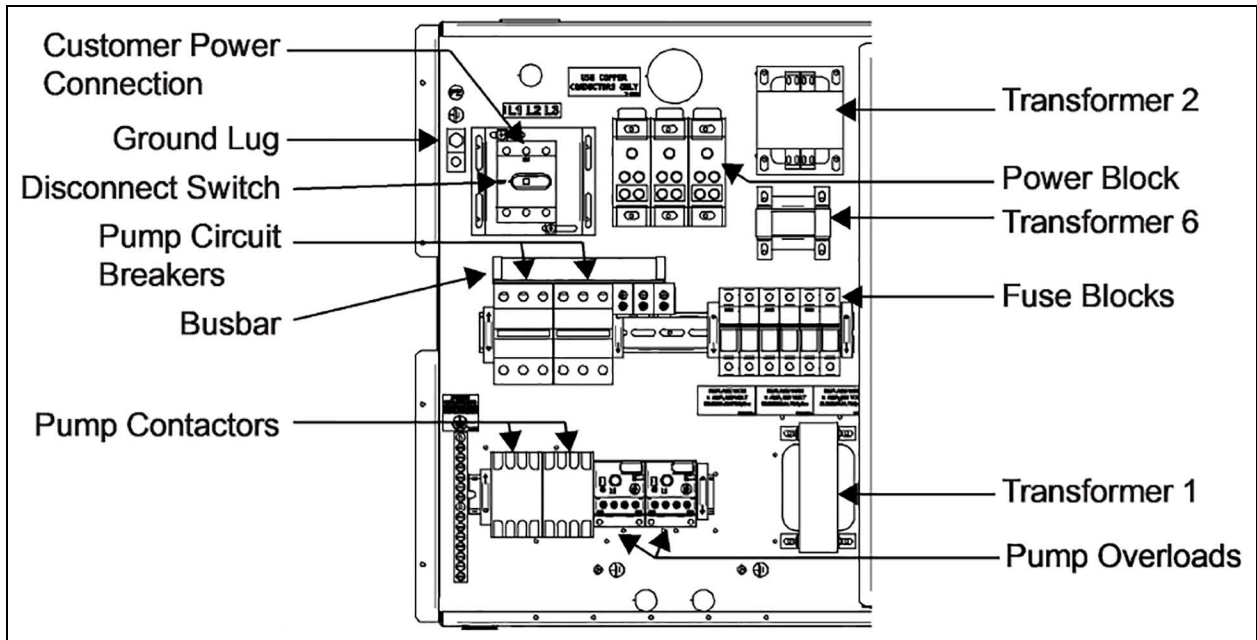

Figure 3.8 High Voltage Connections—50 Hz



3.2.2 External Pump Overloads

The Vertiv™ Liebert® XDP is shipped with external pump overload with trip point settings and DIP switch settings for normal operations. The trip points are in increments of 0.25A and should not be changed from the factory settings. For 460V, the trip point is set at 1.5A (see **Figure 3.9** below). For 208V, the trip point is set at 2.7A (see **Figure 3.10** below). See **Figure 3.11** below for factory DIP switch settings for normal operation with reset mode set as automatic and Trip Class 20.

Figure 3.9 460V Factory Setting External Pump Overload Trip Point

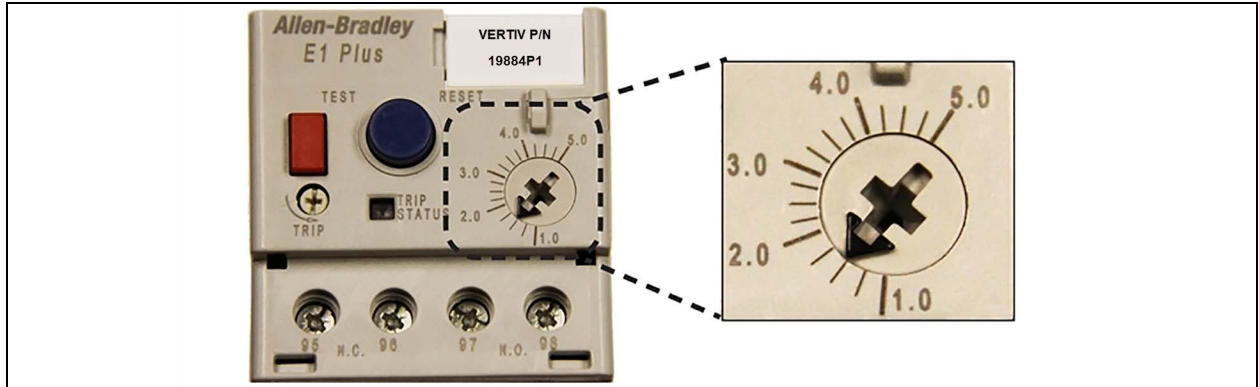

Figure 3.10 208V Factory Setting External Pump Overload Trip Point

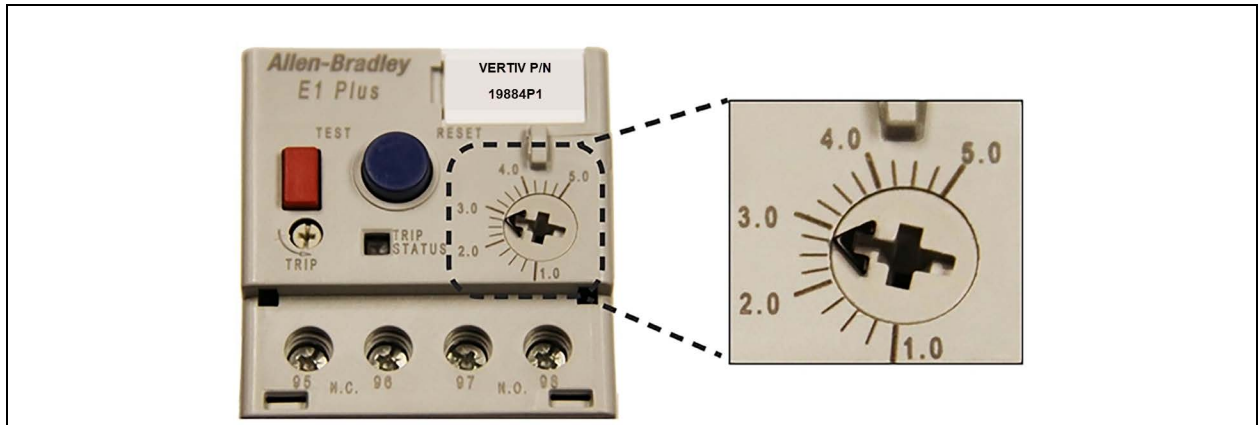
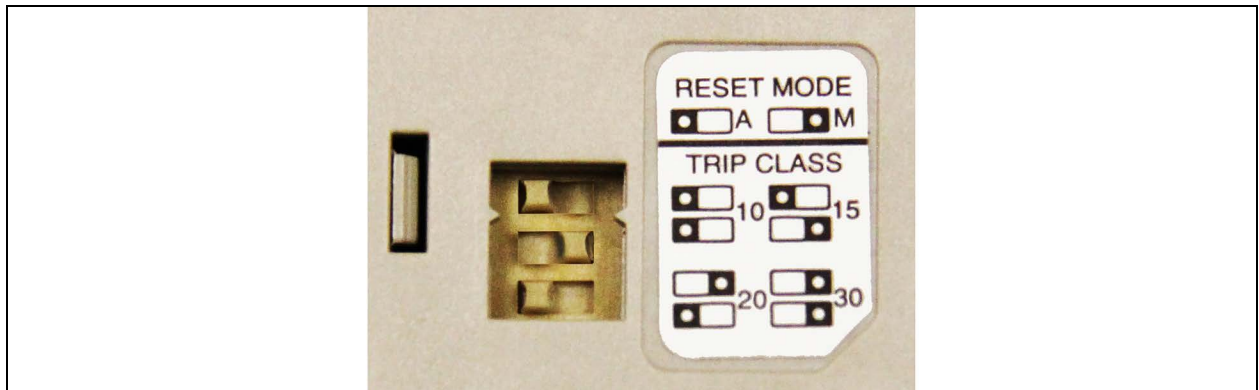

Figure 3.11 Factory DIP Switch Settings



3.2.3 Extra Low Voltage (ELV) Connections

Extra low voltage power output is 30V and 100VA or less.

1. Turn off all power before connecting cables or wires. Failure to do so may damage this equipment (refer to **Figure 3.12** below).
2. Route low voltage electrical connections through the appropriate knockouts as indicated below.

Figure 3.12 Electrical Enclosure Knockout Locations for Extra Low Voltage

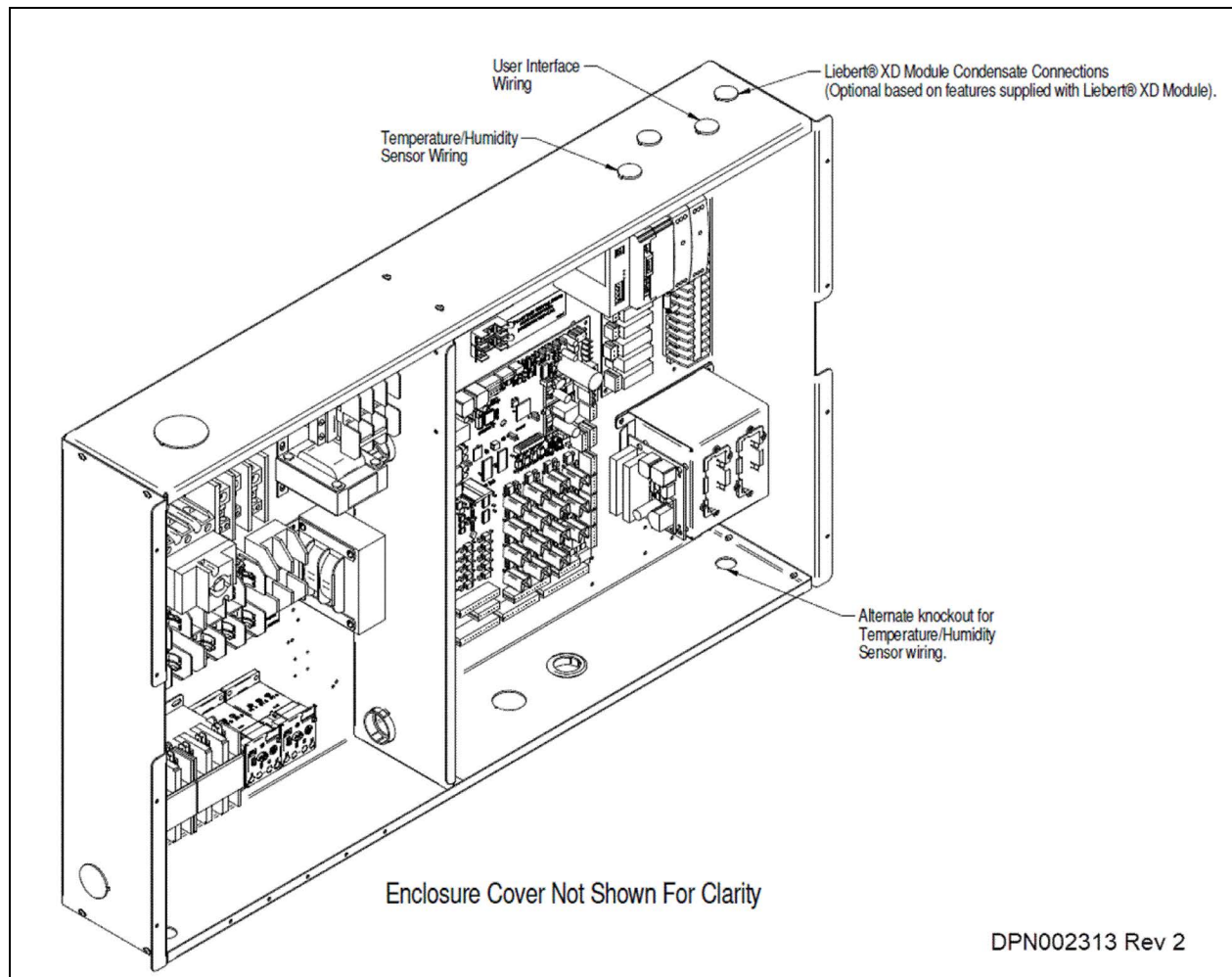
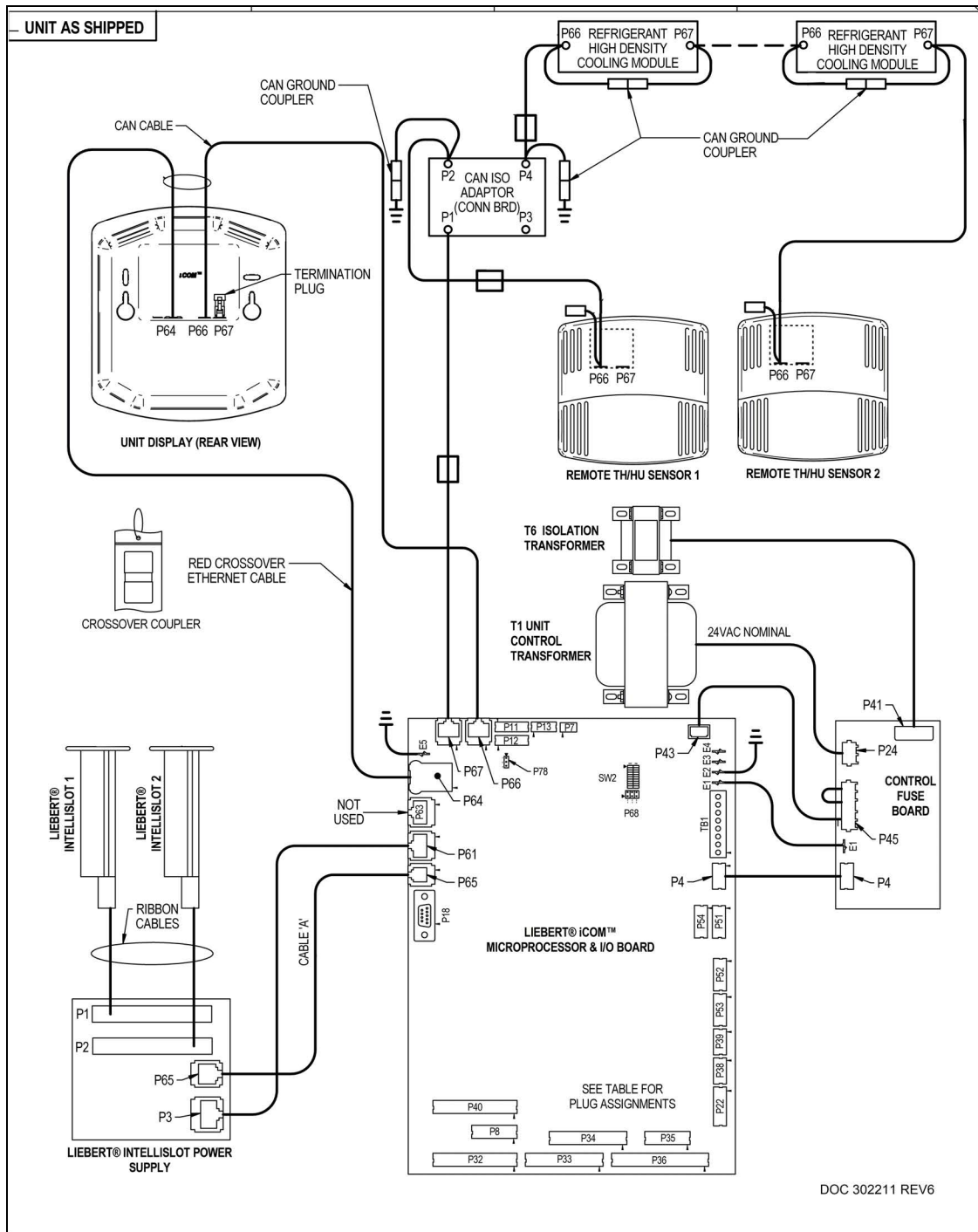

Figure 3.13 Connecting the Remote Temperature/Humidity Sensors



3.2.4 DIP Switch and Jumper Settings for Remote Sensors

The Vertiv™ Liebert® XDP is shipped with jumpers and DIP switch settings for normal operation. See **Figure 3.14** below .

Figure 3.14 DIP Switch and Jumper Settings

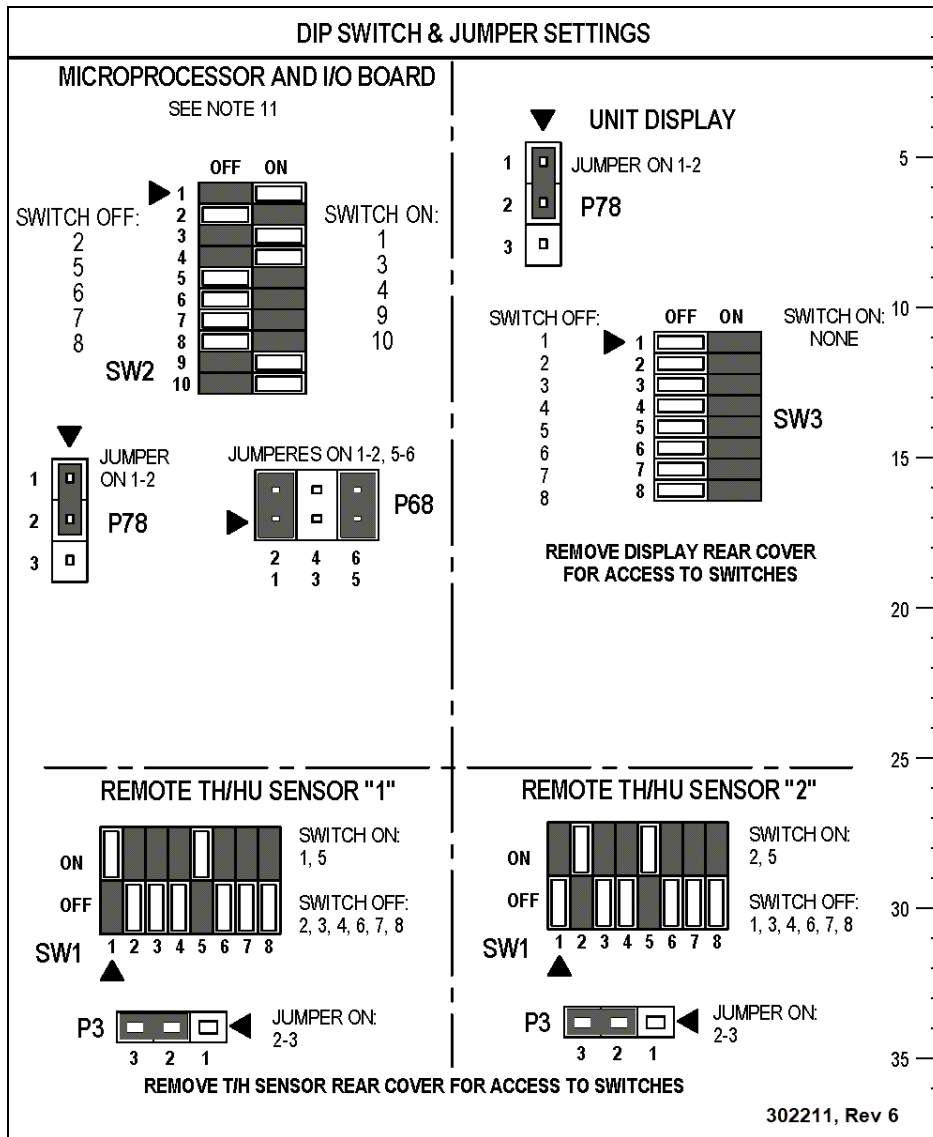
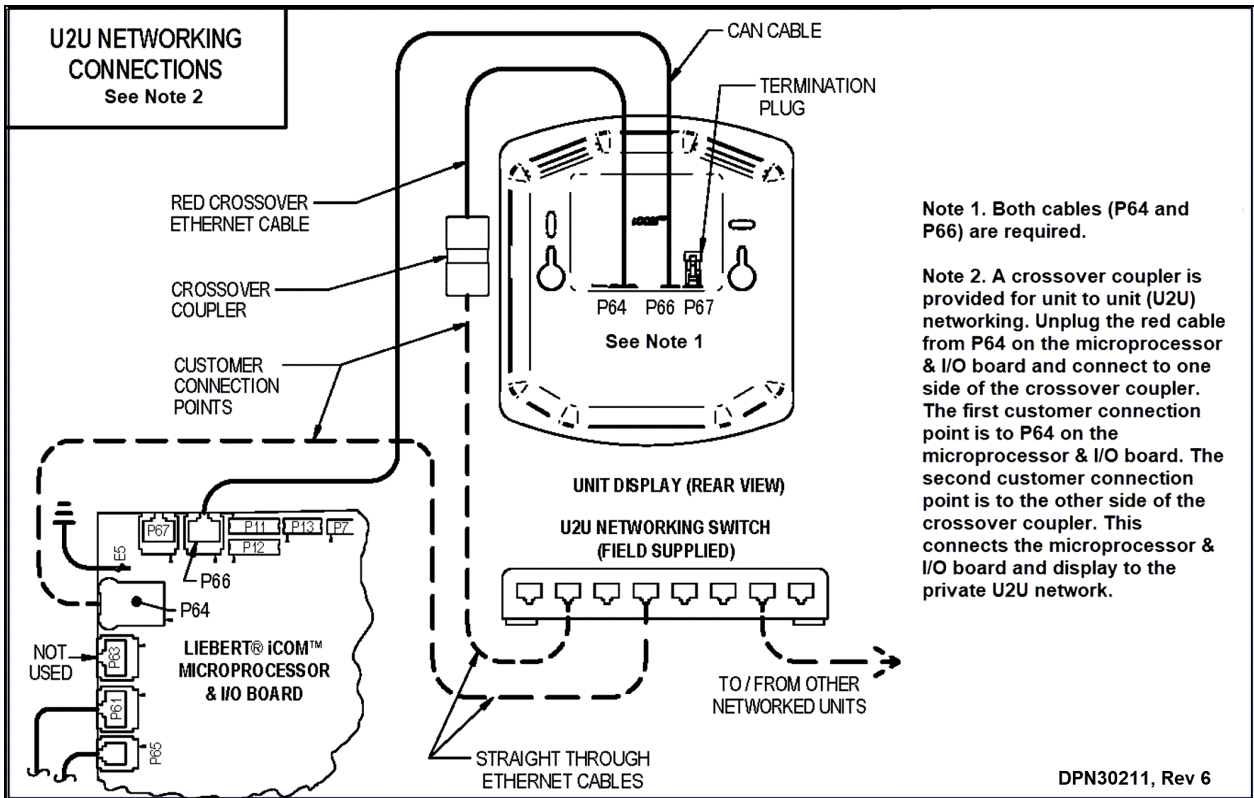

Figure 3.15 Unit-to-Unit Networking Connections



3.3 Field Connections—Optional for All Units

- Connect field wiring from the optional Vertiv™ Liebert® XD cooling module condensation detection circuit to terminal strip locations COMM (24) and H2O (51).
- Connect optional field wiring from remote devices to remote alarm device, common alarm outputs, site monitor and remote shutdown, if applicable. See terminal strip descriptions in **Figure 3.16** below.

Figure 3.16 Vertiv™ Liebert® XDP Extra Low Voltage Field Connections Points

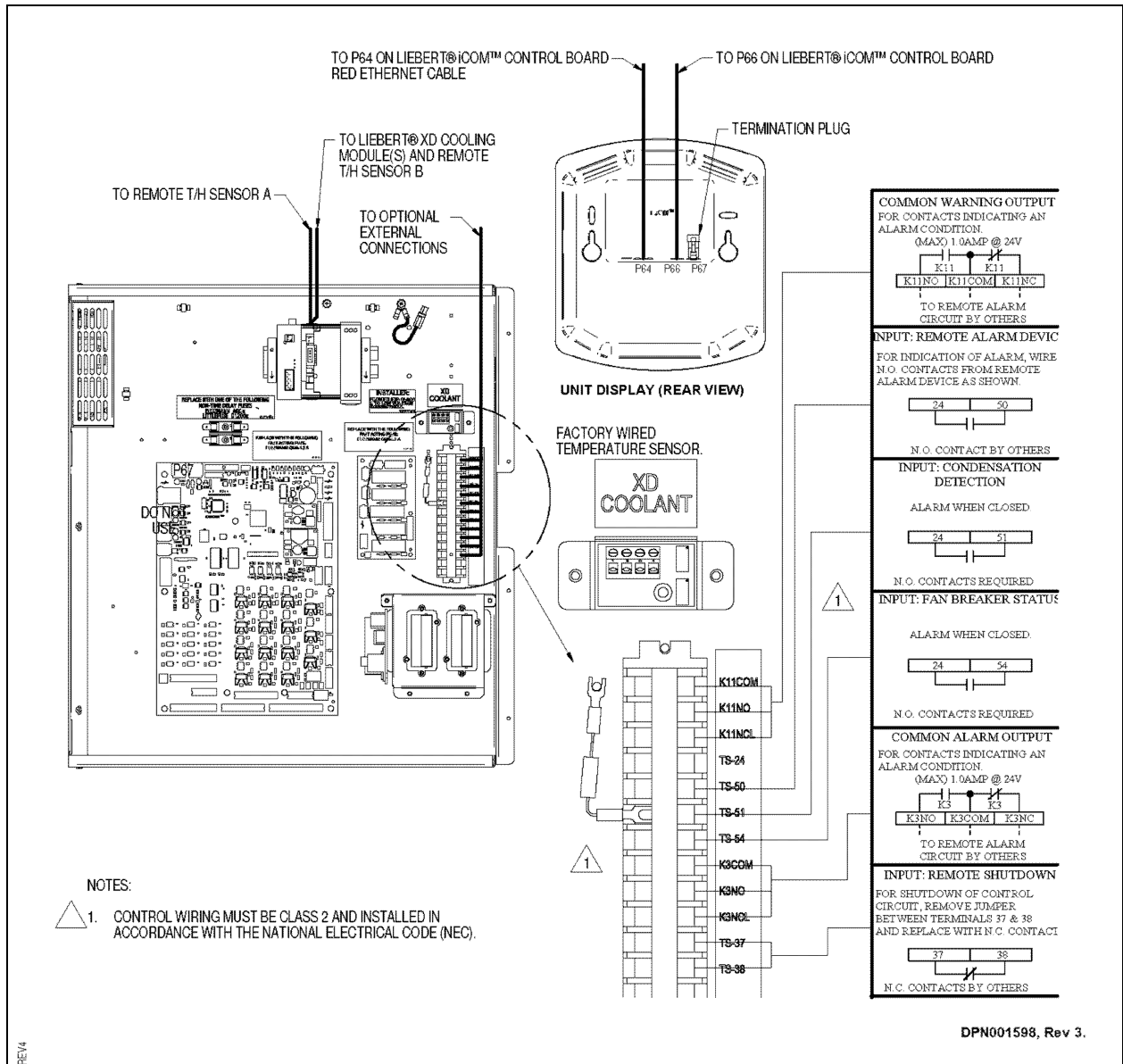

NOTE: Liebert® XDP does not support Teamwork Mode or Standby - Lead/Lag operation.

3.4 Remote Sensor Installation—Proper Placement

Placement of the two remote temperature/humidity sensors is critical to effective cooling of the conditioned space.

The remote sensors must be installed in areas where conditions are representative of the space conditioned by the Vertiv™ Liebert® XDP. Vertiv recommends installing the sensors in different areas near the cooling modules served by the Liebert® XDP. If the return air side of the primary air mover, such as a Liebert® DS, represents the conditions where the Liebert® XD cooling modules are located, one sensor could be placed there. Vertiv suggests placing the other sensor on the wall opposite the heat load area. (See **Figure 3.17** below for guidance).

Do not install the sensors where ambient air might cause false readings, for example, near unsealed doors or windows, or areas with stagnant air.

1. Unpack the two remote temperature/humidity sensors and cables.

One sensor is labeled Sensor A and the other Sensor B. The sensor cables are interchangeable; each bears labels indicating Sensor End and Unit End.
2. Connect the Sensor End of one of the supplied sensor cables to P66 on Sensor A. (See **Figure 3.13** on page 22.)
3. Connect the Unit End of the sensor cable to P67 on the Liebert® iCOM™ input/output board inside the Liebert® XDP. Secure the ring terminal on the cable shield to the electric box adjacent to P67. (See **Figure 3.13** on page 22.)
4. Connect the Sensor End of the second sensor cable to P66 on Sensor B. (See **Figure 3.13** on page 22.)
5. Connect the Unit End of the cable to P67 on the Liebert® iCOM™ display. (See **Figure 3.13** on page 22.) Secure the ring terminal on the cable shield to the grounding screw adjacent to P67.

Figure 3.17 Suggested Remote Sensor Placement

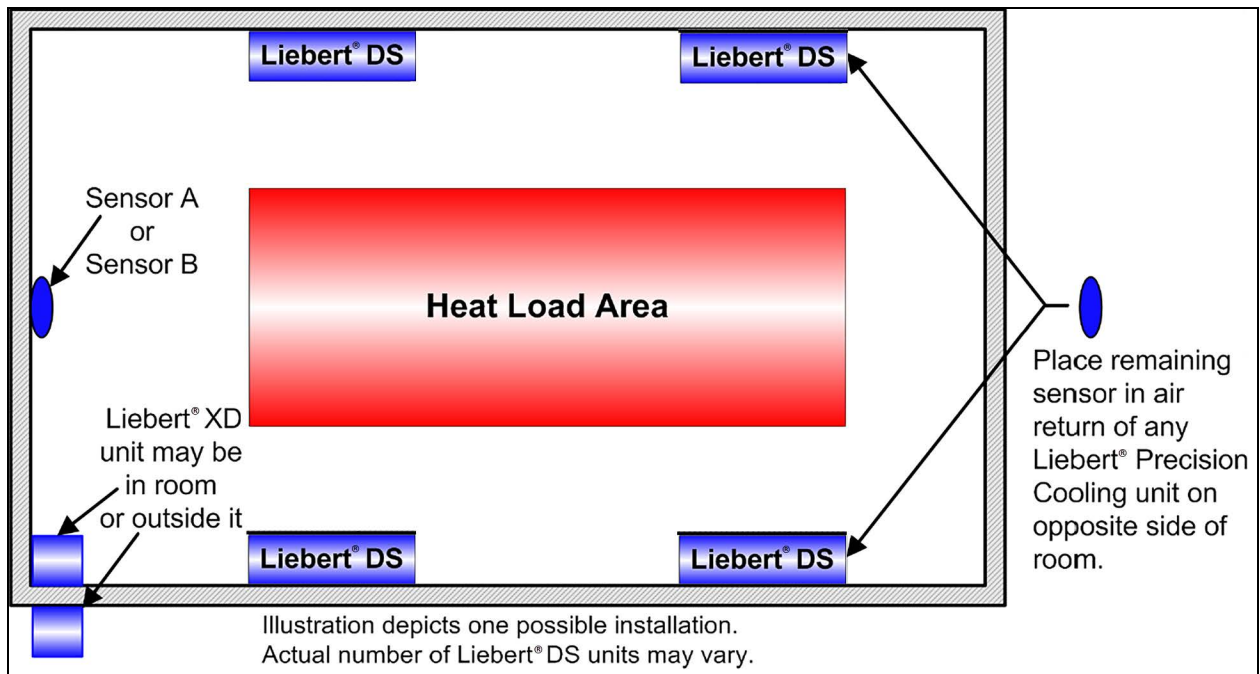

4 Piping

4.1 Connection Sizes

The copper pipe connections on the Vertiv™ Liebert® XDP are:

Building Chilled Water Supply	2-5/8" OD
Building Chilled Water Return	2-5/8" OD
Refrigerant Supply	1-1/8" OD
Refrigerant Return	2-1/8" OD

4.1.1 Recommended Pipe Size

Connect the main pipes between the Vertiv™ Liebert® XDP and the Liebert® XD cooling modules according to site specific documentation and the configuration guide for the Liebert® XD system.

Elbows and restrictions must be minimized to get good fluid flow.

Table 4.1 Supply, Return Pipe Sizes for Refrigerant Loop

Pipe Function	Size/Equivalent Pipe Length
Liebert® XDP supply line, from XDP supply to farthest Liebert® XD cooling module	1-1/8" OD for lengths up to 60 feet
	1-3/8" OD for lengths over 60 but less than 175 feet
Liebert® XDP return line, from farthest Liebert® XD cooling module to XDP return	2-1/8" OD for lengths up to 60 feet
	2-5/8" OD for lengths over 60 but less than 175 feet
From any model Liebert® XDO/Liebert® XDH supply to supply line of Liebert® XDP	1/2" OD for lengths up to 10 feet
	7/8" OD for lengths over 10 but less than 25 feet
From any model Liebert® XDO/Liebert® XDH return to return line of Liebert® XDP	7/8" OD for lengths up to 10 feet
	1-1/8" OD for lengths over 10 but less than 25 feet
From any model Liebert® XDV supply line of Liebert® XDP	1/2" OD for lengths up to 10 feet
	5/8" OD for lengths over 10 but less than 35 feet
From any model Liebert® XDV return line of Liebert® XDP	5/8" OD for lengths up to 10 feet
	7/8" OD for lengths over 10 but less than 35 feet

4.2 Vertiv™ Liebert® XDP Interconnection with Liebert® XD Cooling Modules

All piping must be ASTM (American Society for Testing and Materials) Type ACR copper pipe.

The Liebert® XDP may be connected to Liebert® XD cooling modules with either Liebert®'s XD prefabricated piping assembly or with rigid, off-the-shelf piping. In either setup, piping for the Liebert® XD system is arranged in a manner similar to piping for a chilled water system. Liebert® XD cooling modules are connected in parallel between main return and supply pipes going to and from the Liebert® XDP/Liebert® XDC. **Figure 4.1** below represents a typical configuration. For piping details, refer to the Liebert® XD System Design Manual, SL-16655, available at Vertiv's website: www.Vertiv.com. **The guidelines provided for pipe size must be strictly followed. Failure to size the main lines and connection lines adequately may result in reduced cooling capacity. The critical aspects of pipe sizing are related to refrigerant volume and pressure drop. Each must be minimized.**

Figure 4.1 Liebert® XD System Diagram

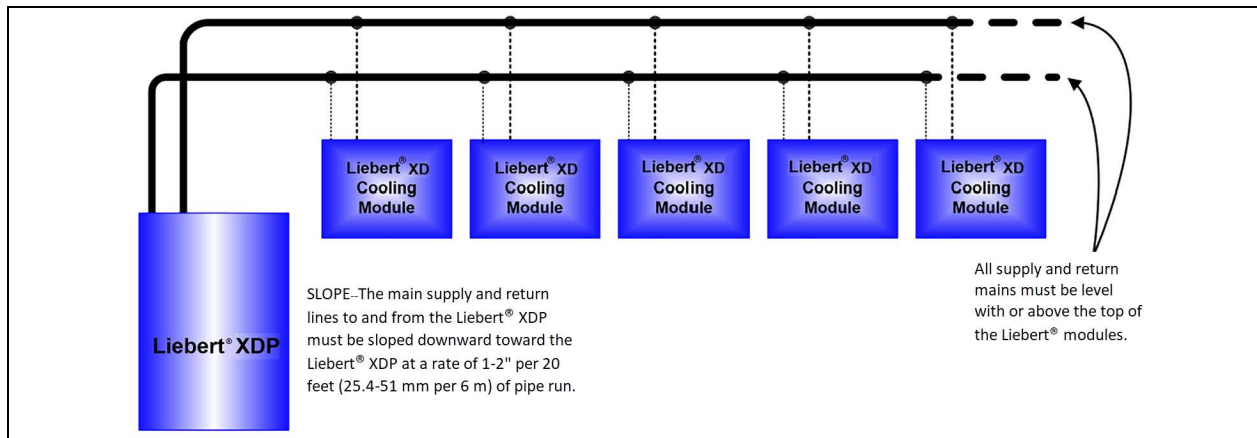

4.3 Piping Installation Methods

The assembly and connection means used for piping in the Vertiv™ Liebert® XD system are similar to those used for conventional refrigeration systems. All piping should be installed with high-temperature brazed joints. Soft soldering is not recommended.

During brazing, the lines must be filled with flowing dry nitrogen to prevent excessive oxidation and scale formation inside the piping. Prevailing good refrigeration practices must be employed for piping supports, leak testing, dehydration and charging. Failure to use good system practices may result in damage to the system. Refer to the ASHRAE refrigeration handbook for general good-practice refrigeration piping.

Insulate all piping lines to prevent condensation in applications where the dew point approaches the R-134a refrigerant temperature.

Vertiv recommends venting the pressure relief valve for the R-134a outside the conditioned space where it is open to the atmosphere. The R-134a side relief valve is inside the Liebert® XDP unit at the top of the receiver.

4.3.1 Piping Installation—R-134a Pumped Circuit

Vertiv recommends venting the relief pressure valve of the Liebert® XDP (located at the top of the receiver) outside of the conditioned space where it is open to the atmosphere.

4.3.2 Piping Mains

All refrigeration piping mains connected to the Vertiv™ Liebert® XDP cooling module, both supply and return, should be installed with a downward pitch toward the Liebert® XDP of 1-2" for every 20 feet (25.4-51mm per 6m) of pipe run. See **Figure 4.1** on the previous page

Install a 20-40 mesh strainer on the chilled water supply to the Liebert® XDP. The strainer is needed to prevent particles in the chilled water from entering the Liebert® XDP's heat exchanger.

4.3.3 Bypass Flow Controller

Three bypass flow controllers are required to ensure that the Vertiv™ Liebert® XDP pumps operate within the optimum range. These devices are added to the field piping and simulate the flow of additional cooling modules.

Each bypass flow controller must be installed with one shutoff valve to allow the controller to be disabled when cooling modules are added to a Vertiv™ Liebert® XDP system.

Bypass flow controllers should be connected between the main supply and the main return lines of the field piping. The connection points to the main supply and return lines should be in a convenient and accessible location between the Liebert® XDP/Liebert® XDC and the first Liebert® XD module in the circuit. See **Figure 4.2** below and **Figure 4.3** on the next page for piping details of the bypass flow controller.

Refer to **Table 4.2** below to determine the number of bypass flow controllers that must be open to provide proper refrigerant flow based on the total nominal cooling capacity of the cooling modules in each Liebert® XD system.

Table 4.2 Bypass Flow Controllers for a Liebert® XDP Based System

System Load kW Cumulative Module Model Size	Required Number of Open Bypass Flow Controllers
	Liebert® XDP
48 to 63	3
64 to 95	2
96 to 127	1
128 to 160	0

Figure 4.2 Bypass Flow Controller Details, Dimensions

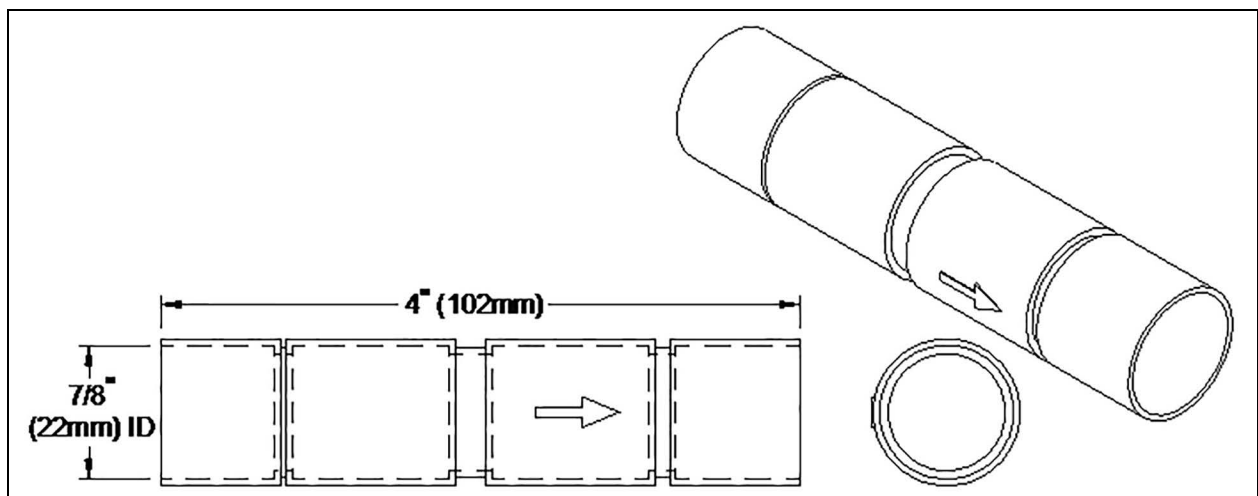

Figure 4.3 Bypass Flow Controller Arrangement

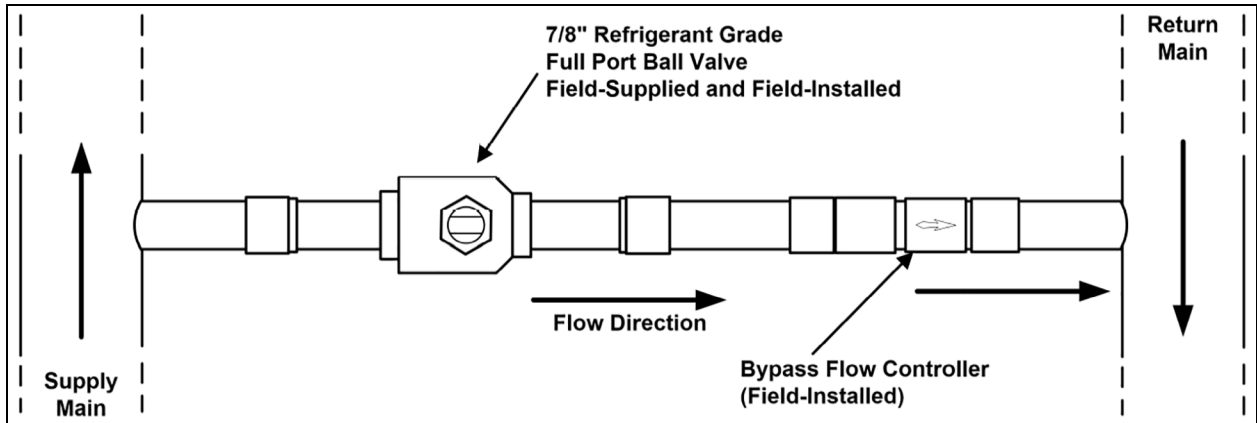
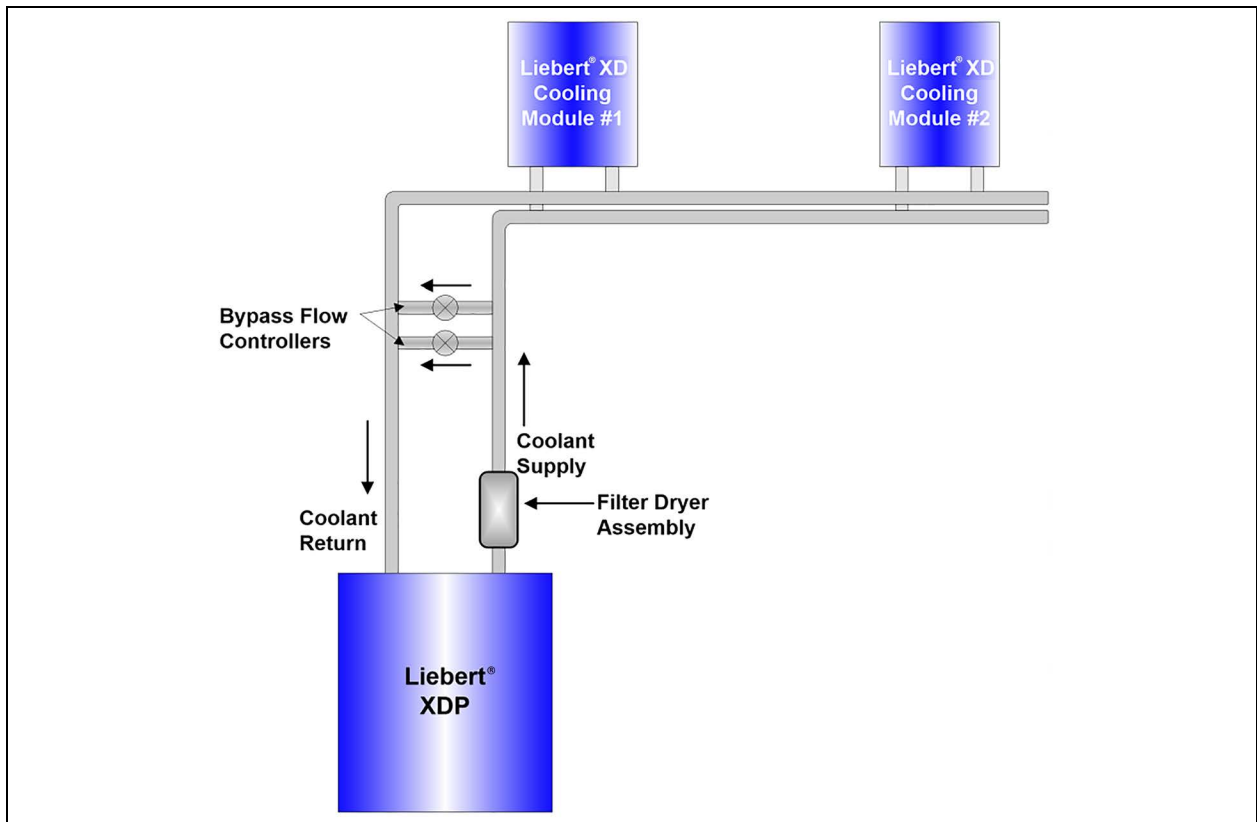

Figure 4.4 Bypass Flow Controller Piping



4.4 Piping Details—Shutoff/Isolation Valves

Isolation valves must be installed on the Vertiv™ Liebert® XDP's refrigerant circuit to permit maintenance on the unit (see Figure 4.5 on the facing page).

Figure 4.5 General Piping Details

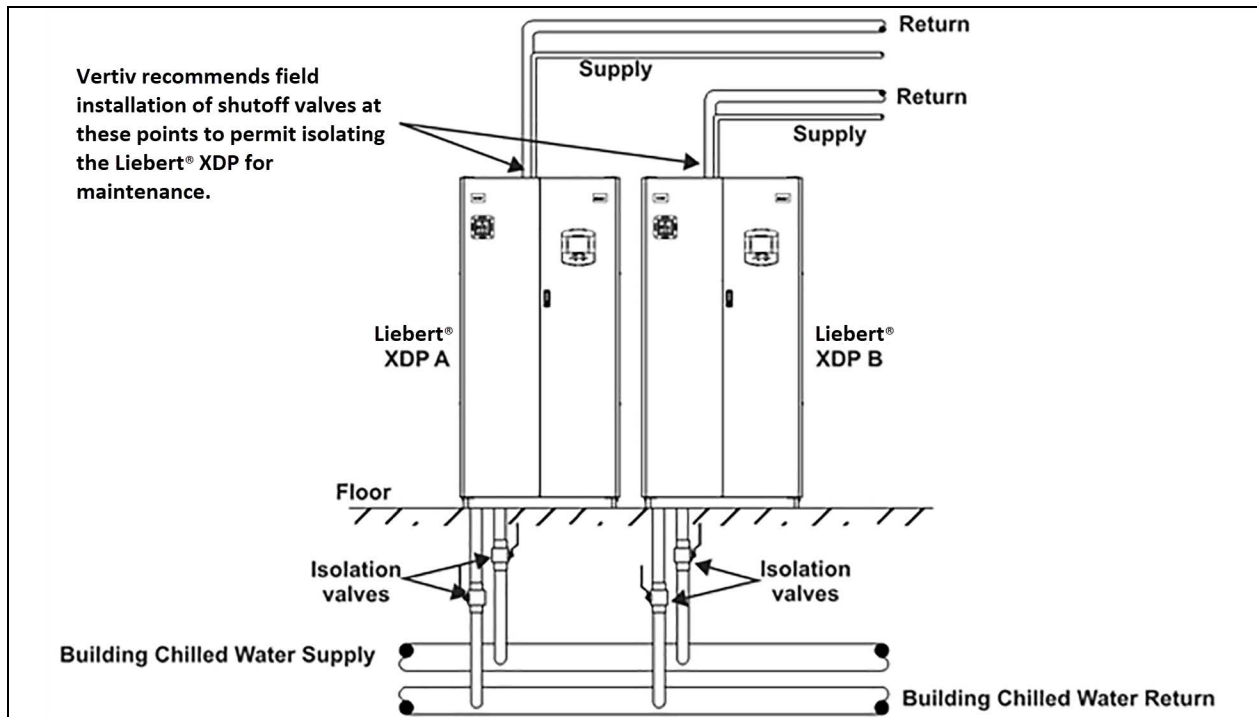

4.4.1 Evacuation and Leak Check—R-134a Pumped Circuit

1. Open all service valves, including those outside the Vertiv™ Liebert® XDP.
2. Attach a jumper hose from one of the Schrader valve fittings on a pump outlet before the check valve to a Schrader valve fittings after the check valve.
3. Place 150psig (1034kPa; 10.34 bars) of dry nitrogen with a tracer of R-134a in the system.

NOTICE

Risk of overpressurization. Can cause equipment damage.

Do not exceed 150 psig (1034 kPa; 10.34 bars) in the R-134a circuit.

4. Check the system for leaks with a suitable leak finder on the pumps' suction lines.
5. After completion of the leak testing, release the test pressure (per local code) and connect to vacuum pump(s) at the Schrader valves.
6. After pulling a deep vacuum for four hours, check the vacuum level and, if it has not changed, break the vacuum with dry nitrogen.
7. Pull a second vacuum to 250 microns or less. Recheck the vacuum level after 2 hours.

4.4.2 Insulation

NOTE: Do not insulate piping before checking it for leaks. Insulating pipes before checking them for leaks would prevent easy detection of leaks.

Insulate all piping between the Vertiv™ Liebert® XDP and its connected cooling modules to prevent condensation where the piping passes through non-conditioned areas.

4.5 Filling the Pumped Circuit—R-134a

Using a refrigerant pump or cylinder heater pads will speed the charging process.

1. Connect a charging manifold to the service port of the receiver outlet valve or to the suction and discharge side of the pump.
2. Purge the hoses.
3. Calculate the amount of R-134a refrigerant needed to charge the system, using the values in
 - [Filling the Pumped Circuit—R-134a](#) above
 - **Table 4.4** on the facing page
 - **Table 4.5** on the facing page
 - For assistance, refer to [Calculating Refrigerant Charge—Example](#) on the facing page [Calculating Refrigerant Charge—Example](#) on the facing page . The section includes a worksheet to calculate system refrigerant charge requirements.
4. Weigh in the calculated charge.
5. After adding the calculated charge, allow the system to sit 15 to 30 minutes to reach equilibrium. Observe the refrigerant level through the sight glasses of the receiver. The level should be above the second sight glass at a minimum when the Liebert® XDP is off.
6. If the refrigerant level is improper, the charge must be adjusted.

If the level is too high or too low, recalculate the required charge and reduce or increase the amount as needed to reach the proper level.

NOTE: All lengths in [Filling the Pumped Circuit—R-134a](#) above , **Table 4.4** on the facing page and **Table 4.5** on the facing page are actual pipe lengths, not equivalent pipe lengths.

NOTE: System refrigerant volume calculations derived from [Filling the Pumped Circuit—R-134a](#) above , **Table 4.4** on the facing page and **Table 4.5** on the facing page are based on a fully loaded system. Additional charge may be required for lightly loaded systems.

Table 4.3 System R-134a Charge for a Liebert® XDP with Any Model Liebert® XDV/XDH/XDO

Refrigerant Charge, lb. (kg)	Per Liebert® XD Unit (Excludes Connector Lines to and from Liebert® XD Cooling Module)
5.32 lb. (2.41kg)	Liebert® XDH
3.55 lb. (1.61kg)	Liebert® XDO
1.57 lb. (71.2kg)	Liebert® XDP
2.32 lb. (1.05kg)	Liebert® XDV

Table 4.4 System Refrigerant Charge for the Supply and Return Mains

Refrigerant Charge, lb/foot (kg/m)	Supply/Return Main Length and Diameter
0.45 (0.67)	Main supply actual length per 1-1/8" OD copper tubing
0.68 (1.01)	Main supply actual length per 1-3/8" OD copper tubing
0.28 (0.42)	Main return actual length per 2-1/8" OD copper tubing
0.43 (0.64)	Main return actual length per 2-5/8" OD copper tubing

Before beginning, verify that the system is not equipped with pre-charged Liebert® XD Flex Pipe.

Table 4.5 R-134a Refrigerant Charge for Hard Piped Connector Lines to and From Any Model Liebert® XDH/Liebert® XDO/Liebert® XDV

Refrigerant Charge, lb/foot (kg/m)	Hard Piped Connector Length and Diameter
0.08 (0.12)	1/2" OD Liebert® XDO/Liebert® XDH/Liebert® XDV supply connector actual length
0.13 (0.19)	5/8" OD copper tubing Liebert® XDV supply connector actual length
0.26 (0.39)	7/8" OD Liebert® XDO/Liebert® XDH supply connector actual length
0.02 (0.03)	5/8" OD copper tubing Liebert® XDV return connector actual length
0.04 (0.06)	7/8" OD copper tubing Liebert® XDV return connector actual length
0.04 (0.06)	7/8" OD copper tubing Liebert® XDH/Liebert® XDO return connector actual length
0.07 (0.1)	1-1/8" OD copper tubing Liebert® XDH/Liebert® XDO return connector actual length

4.5.1 Calculating Refrigerant Charge—Example

Using [Filling the Pumped Circuit—R-134a](#) on the previous page, [Table 4.4](#) above, [Table 4.5](#) above, calculate the refrigerant charge of the individual sections of your Liebert® XD system. Add the calculated charge amounts to determine the amount of R-134a refrigerant required for one system combining a Liebert® XDP with Liebert® XD cooling modules (Liebert® XDH, Liebert® XDO, and Liebert® XDV). The example below combines one Liebert® XDP with 20 Liebert® XDV8 cooling modules.

Table 4.6 Calculating Refrigerant Charge—Example

Components	Number of Units or Piping Length, feet	Pounds Per Component	Total, lb.
Liebert® XDP	1	157	157
Liebert® XDV8 Cooling Modules	20	2.32	46.4
Supply Main, 1-1/8"	100	0.45	45
Return Main, 2-1/8"	100	0.28	28
		Total	276

5 Vertiv™ Liebert® iCOM™ Control—Firmware Version XP1.00.010.STD

5.1 Liebert® iCOM™ Components and Functions

The Liebert® iCOM™ controller layout is shown in **Figure 5.1** below ; the keyboard functions are defined in **Table 5.1** on page 37 .

Figure 5.1 Liebert® iCOM™ Display Components

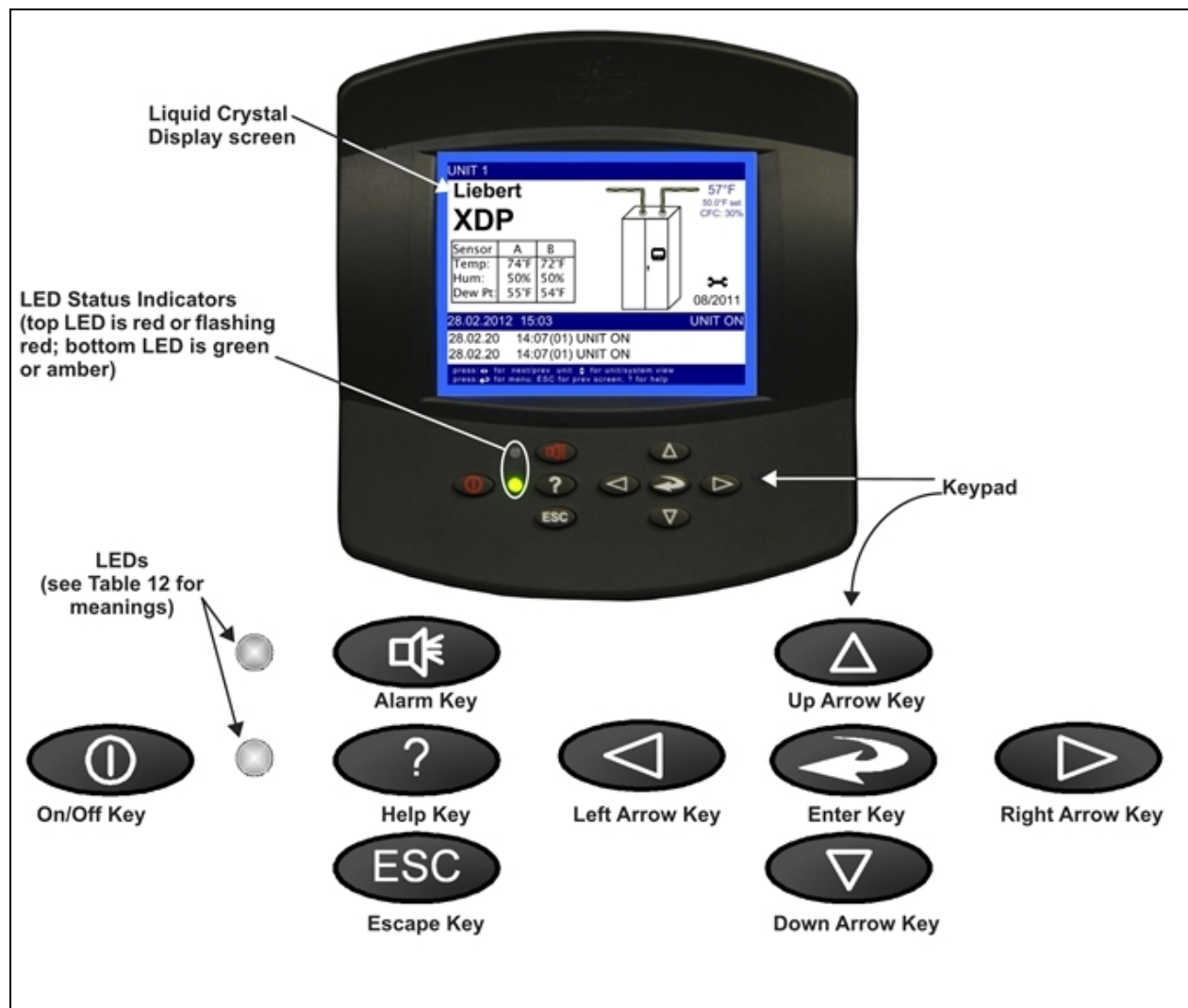

NOTE: Liebert® XDP does not support Teamwork Mode or Standby - Lead/Lag operation.

Table 5.1 Keyboard Icons and Functions







Icon	Key Name	Function
	On/Off Key	Controls the operational state of the cooling unit.
	Alarm Key	Silences an alarm.
	Help Key	Accesses integrated Help menus.
	ESCape Key	Returns to the previous display view.
	Enter Key	Confirms all selections and selects icons or text.
	Increase Key (Up Arrow)	Moves upward in a menu or increases the value of a selected parameter.
	Decrease Key (Down Arrow)	Moves downward in a menu or reduces the value of a selected parameter.
	Left and Right Arrow Keys	Navigates through text and sections of the display.
	Upper LED	Blinking Red—Active, unacknowledged alarm exists

Table 5.1 Keyboard Icons and Functions (continued)

Icon	Key Name	Function
		Solid Red—Active, acknowledged alarm exists
	Lower LED	Amber—Power is available to the unit; unit is NOT operating
		Green—Unit is operating with no alarms

5.2 Display Lamp Indicators

- The Green lamp will be On only when the Vertiv™ Liebert® XDP is ON and running with no alarms.
- The Red lamp will be ON if the unit is ON and running with an active alarm, or if the unit is shut down because of an alarm.
- The Red lamp will flash while an alarm is being annunciated. The Red lamp will stop flashing and the beeper in the display will stop beeping when the ALARM SILENCE/? key is pressed.
- The Amber lamp will be On if the Liebert® XDP has been shut down at the I/O switch or if the unit has been shut down by an alarm condition.

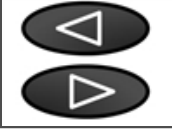
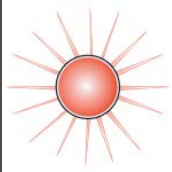
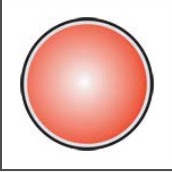
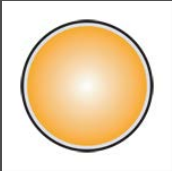
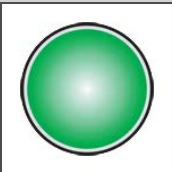
5.3 Navigating Through the Vertiv™ Liebert® iCOM™ Display

Liebert® iCOM™ displays icons and text for monitoring and controlling your Liebert cooling unit. The Liebert® iCOM™ home screen is shown in **Figure 5.2** on the next page.

Figure 5.2 Vertiv™ Liebert® iCOM™ Default Home Screen

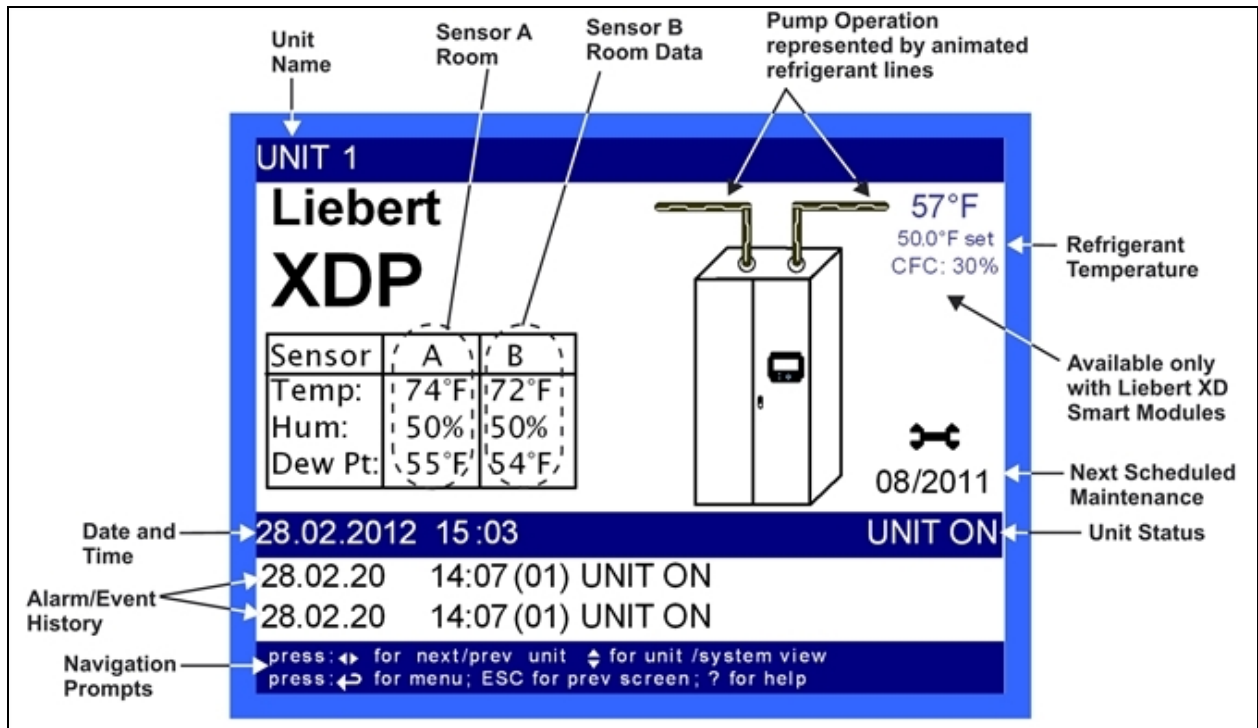

5.3.1 Accessing Menus and Settings

Viewing Data

No password is required to view data or settings.

To view data:

1. From the home screen, press the **Enter** key to view the User Menu. See [Vertiv™ Liebert® iCOM™ User Menu Icons and Legend](#) on page 42.
2. Press **Enter** again to highlight the first icon.
3. Use the keyboard's arrow keys to move to the icon for the data you wish to view.
4. Once that icon is highlighted, press **Enter** again to open that menu.
 - If a password is required, see [Entering the Password](#) on the facing page.
 - If a menu has more than one screen, the Liebert® iCOM™ display will have text at the top similar to this: *(page 1 of 2)*.
5. Press **Enter** to select the first line of data.
6. Use the **Up** and **Down** arrow keys to scroll to the desired data point.
7. Press **ESC** to move back to higher level menus.

5.3.2 Cooling Module Overview

The Vertiv™ Liebert® iCOM™ will display an overview of all connected cooling modules. It does not display a system view, which would include units other than the cooling modules.

NOTE: The Liebert® iCOM™ control screens display a setting to select a system view, but the Liebert® XDP does not support a system view.

To display an overview of all connected cooling modules:

1. At the default home screen on the Liebert® iCOM™, press the down arrow. This will display the first 10 modules outlet temperature and capacity levels. Press ESC to return to the unit view.

Figure 5.3 Cooling Module Overview, First 10 Modules

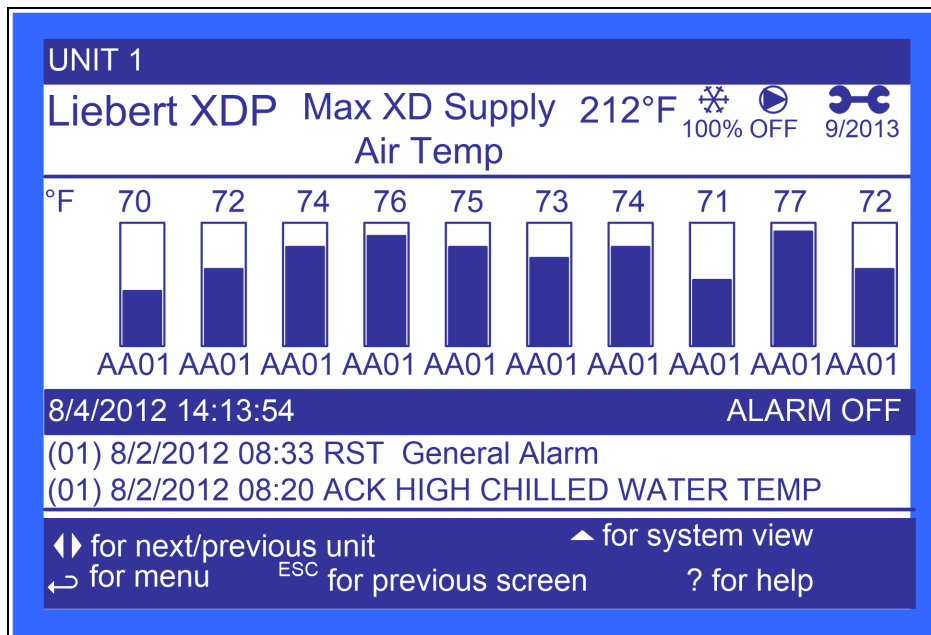

2. Press the down arrow button again to display the next 10 modules' outlet temperature and capacity levels.
3. Press ESC to return to the default home screen.

5.3.3 Entering the Password

Most settings in the Vertiv™ Liebert® iCOM™ are protected by a factory-set password, 1490. To enter the password:

1. From the home screen, press the **Enter** key to view the User Menu. (See [Vertiv™ Liebert® iCOM™ User Menu Icons and Legend](#) on page 42.)
2. Press **Enter** again to highlight the first icon.
3. Use the keyboard's arrow keys to move to the icon for the data you wish to change.
4. Once that icon is highlighted, press **Enter** again to open that menu.
5. Press **Enter** to highlight the Password line.
6. With the Password line highlighted, press **Enter** to highlight the first digit in the password.

7. Enter the password, 1490.

Use the **Up** and **Down** arrow keys to select a numeral for the first digit of the password.

Move to the next digit of the password with the **Right** arrow key.

Select the numerals for all four digits with the same process.

8. After all four digits of the password have been entered, press the **Enter** key.

NOTE: Do not press the ESC key or the Liebert® iCOM™ will move to the previous screen and the password must be re-entered before changes may be made.

Figure 5.4 Entering the Password

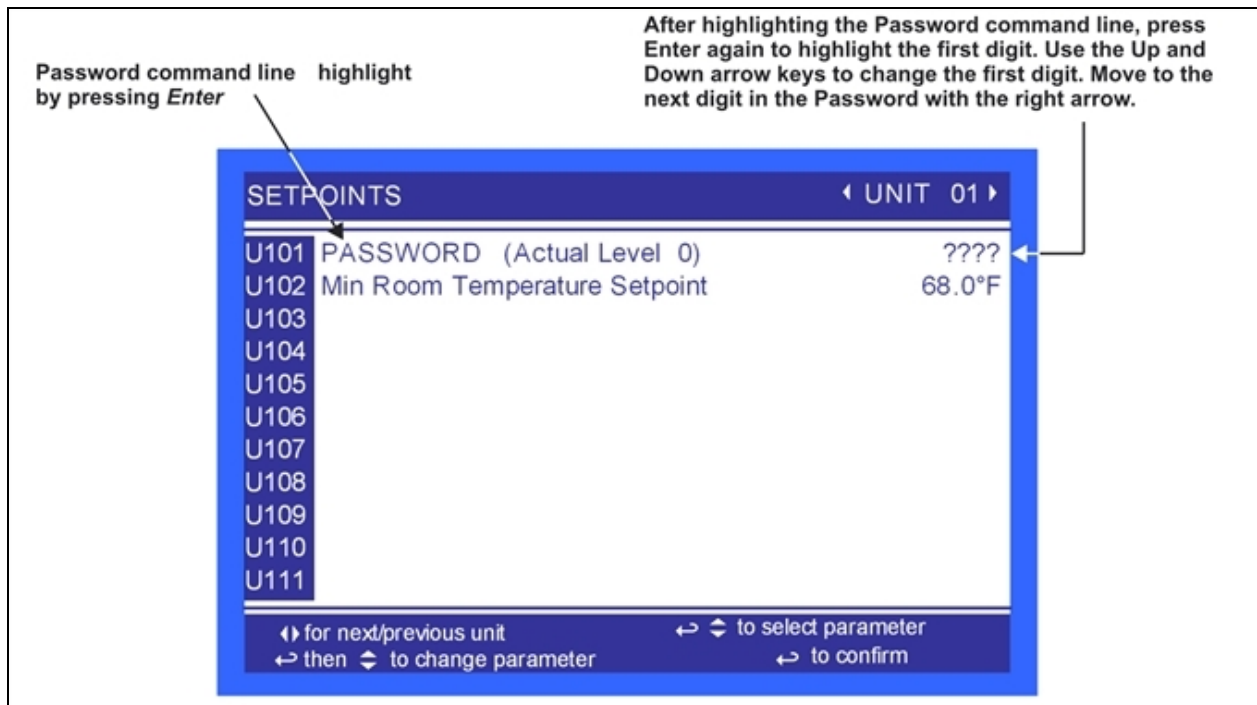

5.4 Changing Vertiv™ Liebert® iCOM™ Display Settings

No password is required to change the way Liebert® iCOM™ displays data. The Display Setup controls how the unit shows data, such as temperature, date and time.

To change the display settings:

1. From the home screen, press the **Enter** key to view the User Menu.(See [Vertiv™ Liebert® iCOM™ User Menu Icons and Legend](#) on page 42.)
2. Press **Enter** again to highlight the first icon.
3. Use the keyboard's arrow keys to move to the Display Setup icon.
4. Once that icon is highlighted, press **Enter** again to open that menu.
5. Press the **Enter** key to select the first setting.

Either change that setting or navigate to another setting with the **Up** and **Down** arrow keys.

6. Once the desired setting is highlighted, press the **Enter** key to access that parameter's display setting options.
7. Use the **Up** and **Down** arrow keys to make changes.

8. Press the **Enter** key to accept the changes.
9. Press the **ESC** key twice to return to the Liebert® iCOM™ user menu.

Figure 5.5 Display Setup Screen

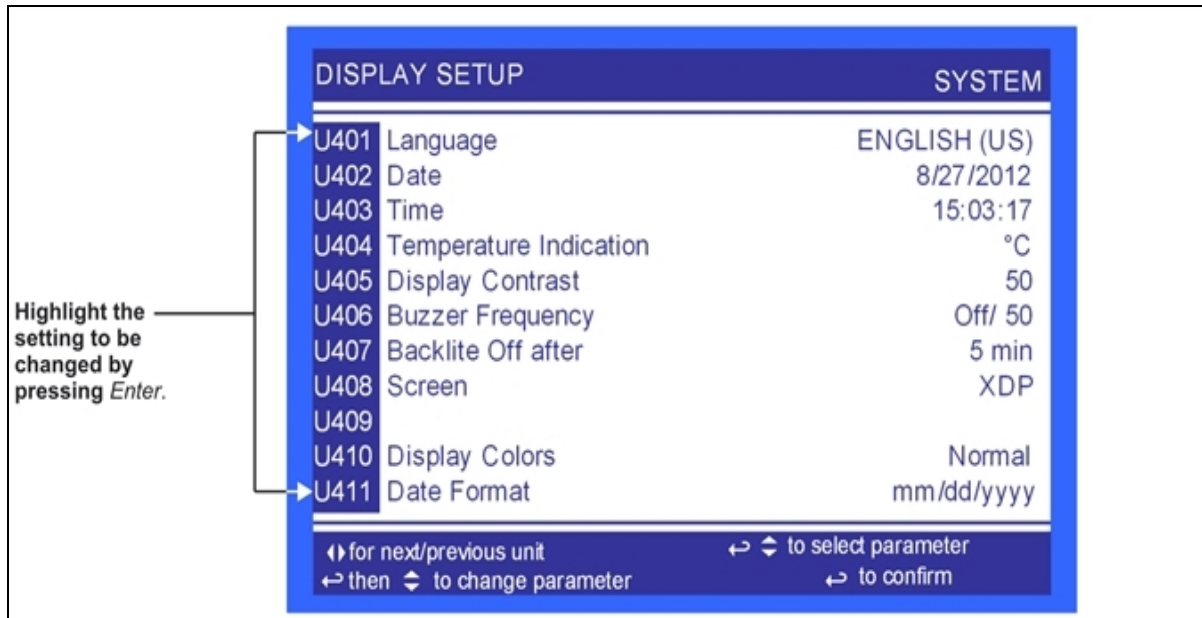

5.5 Changing Operational Settings

Changes to the Vertiv™ Liebert® XDP's operation settings in the **Set Alarms** and **Setpoints** menus require a password.

1. From the home screen, press the **Enter** key to view the User Menu. (See [Vertiv™ Liebert® iCOM™ User Menu Icons and Legend](#) on the next page.)
2. Press **Enter** again to highlight the first icon.
3. Use the keyboard's arrow keys to move to the icon for the data you wish to change.
4. Once that icon is highlighted, press **Enter** again to open that menu.

If a password is required, see [Entering the Password](#) on page 39.

5. After entering the password, use the **Up** and **Down** arrow keys to scroll to and highlight the operational setting to be changed.
6. Press **Enter** to highlight the values for that setting.
7. Use the **Up** and **Down** arrow keys to change the value.
8. Press **Enter** to accept the change. (The value will no longer be highlighted.)
9. Press **ESC** to deselect the operational setting. (The setting will no longer be highlighted.)
10. Press **ESC** again to move to previous screens.

5.6 Graphical Data Record

The Graphical Data Record charts the average temperature from Sensors A and B and the supply refrigerant temperature.

The temperature scales can be changed to expand or compress the data.

The time scale also can be altered to any of several selectable values.

NOTE: Changing the time scale eliminates all previous graphical data and the unit will begin recording new data.

5.7 Vertiv™ Liebert® iCOM™ User Menu Icons and Legend

Table 5.2 Liebert® iCOM™ User Menu Icons Descriptions

Item	Description	Item	Description
	Setpoints - View and change operational setpoints		Set Alarms - Allows user to change settings for alarms
	Spare Parts List - Contains spare parts available on site		Sensor Data - Shows readings of sensors; View Only
	Event Log - Lists last 400 events and alarms. View Only		Active Alarms - Lists all current alarms; View Only
	Graphic Data Record - Displays average temperature from Sensors A and B, the average dewpoint from Sensors A and B, the supply refrigerant temperature and the supply refrigerant control point graphs; Data is View Only; Display scale is adjustable		Display Setup - Change settings for display; language and time
	View Network - Shows status of all connected units; View Only		Total Run Hours - Records the run time of all components and allows setting of limits on run time; View Only
	XDIO - Displays readings for the individual smart modules; View Only		Service Contacts - Contains key contact information for service

NOTE: Menu shows icons only; text is explanatory and does not appear on the Liebert® iCOM™ display.

Figure 5.6 Vertiv™ Liebert® XDP User Menu Screen

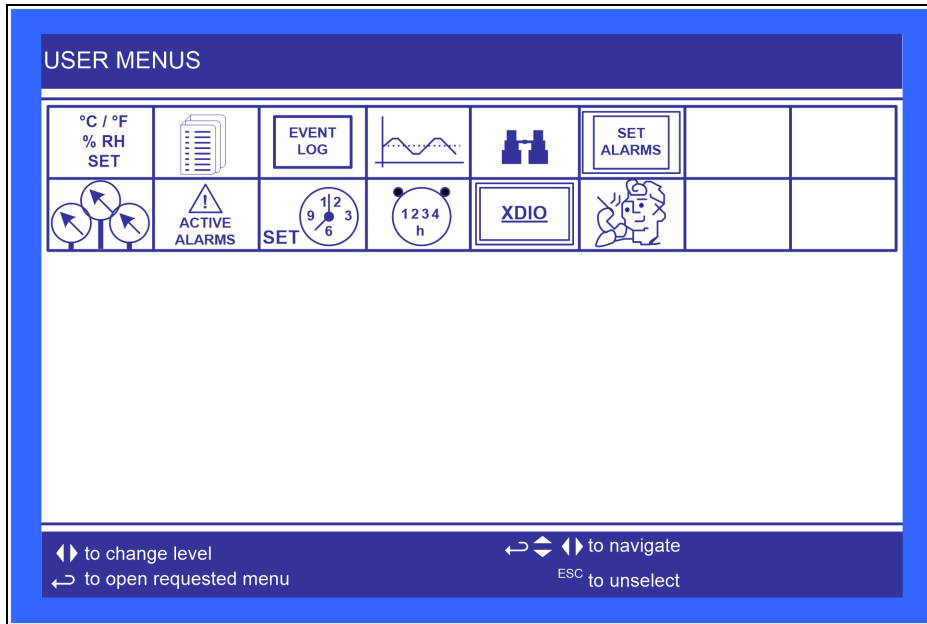

5.8 Vertiv™ Liebert® iCOM™ User Menu Screens

User menus report general cooling unit operations and status. User menu screens employ a coding that begins with U and is followed by parameters and information, such as settings. Gaining access to some User menu screens requires entering a password; the User Menu password is **1490**.

Check www.Vertiv.com for the latest Liebert® iCOM™ User Manual updates, SL-18835.

Figure 5.7 Setpoints Screen

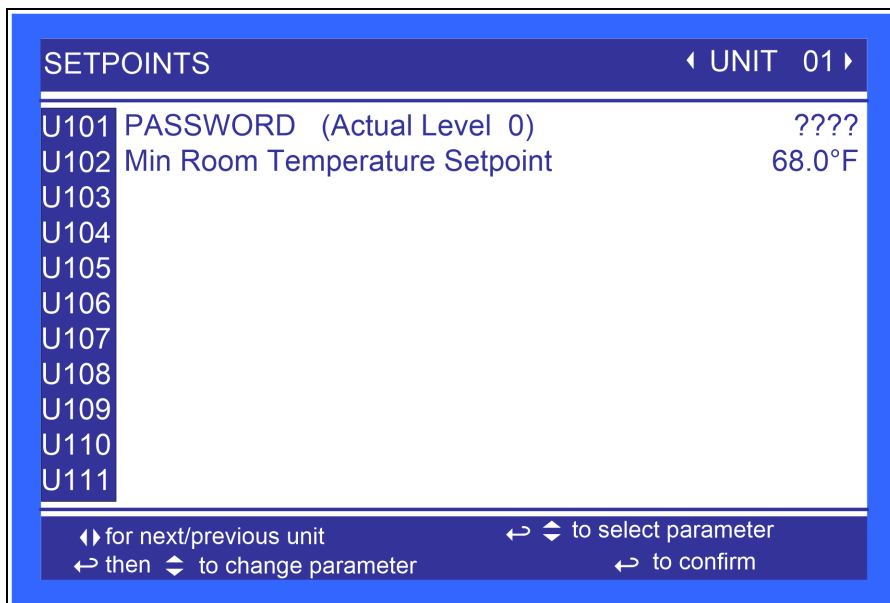

Min Room Temperature Setpoint—Sets the minimum room temperature the unit will attempt to maintain. If the temperature falls below this point, the unit will raise the refrigerant temperature to reduce the amount of cooling.

The setting is intended to keep the room temperature above the setpoint. Without a proper setpoint, the Vertiv™ Liebert® XDP can lower the room temperature too much, depending on the room dew point and load. This setpoint will reduce the cooling to keep the room temperature above this desired temperature.

NOTE: This is not a true room temperature setpoint. The Liebert® XDP has no heaters; it will try to cool as much as possible. If the Liebert® XDP is able to cool the room to this setpoint, it will reduce its cooling action to try to keep the room temperature at or above this setpoint.

The default setting is 60°F (15.6°C). The range is 50-80°F (10-27°C).

For optimal cooling performance, the minimum temperature setpoint should be at least 1-2° below the expected temperature at the remote sensors, which may affect placement of the remote sensors. If the minimum temperature setpoint is set above the typical remote temperature sensor reading, it will reduce the Liebert® XD cooling output and, in extreme cases, cause erratic Liebert® XD performance.

Spare Parts

Spare Parts—The spare parts lists contains a detailed description and part number that can be used to order parts for the unit. These part numbers are specific to each model and option installed on the unit.

Event Log

Event Log—The event log displays all events and actions that have been generated by the unit. When multiple units are networked you will see the event log of the whole system. Each event shows the unit that generated the alarm, time and date stamp, a description and the event type.

Figure 5.8 Set Alarms Screen

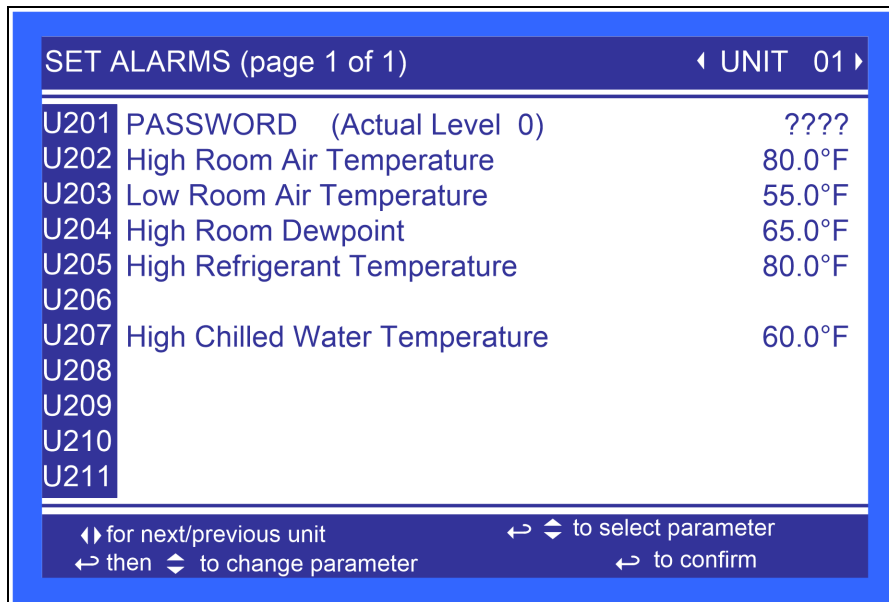

High Room Air Temperature—Sets the threshold where a high room temperature alarm will occur, based on the actual reading from either remote Sensor A or B. The range for the high room air temperature alarm is 33.8-95°F (1-35°C); the default is 80.0°F (26.7°C).

Low Room Air Temperature—Sets the threshold where a low room temperature alarm will occur, based on the actual reading from either remote Sensor A or B. The range for the high room air temperature alarm is from 33.8 to 95°F (1 to 35°C); the default is 55.0°F (12.8°C).

High Room Dewpoint—Sets the threshold where a high room dew point alarm will occur, based on the calculated values from either remote Sensor A or remote Sensor B. The range for the high room dew point alarm is from 33.8 to 95°F (1 to 35°C); the default is 65°F (18.3°C).

High Refrigerant Temperature—Sets the threshold where a high refrigerant temperature alarm will occur based on the actual reading from the supply refrigerant sensor. The supply refrigerant temperature is from the Liebert® XDP to the modules. The range for the high supply refrigerant temperature alarm is from 33.8 to 95°F (1 to 35°C); the default is 80°F (26.7°C).

High Chilled Water Temperature—Sets the threshold where a high chilled water temperature alarm will occur based on the actual reading from the supply chilled water sensor. The range for the high chilled water temperature is from 33.8 to 95°F (1 to 35°C); the default is 60°F (15.6°C).

Figure 5.9 Sensor Data Screen, page 1 of 2

SENSOR DATA (page 1 of 2)		◀ UNIT 01 ▶
U301	Sensor A Temperature	62.8°F
U302	Sensor A Humidity	42.20%
U303	Sensor A Dew Point	39.4°F
U304	Sensor B Temperature	71.2°F
U305	Sensor B Humidity	29.60%
U306	Sensor B Dew Point	37.8°F
U307	Supply Refrigerant Temperature	55.0°F
U308		
U309		
U310	Supply Chilled Water Temperature	55.0°F
U311		
U312		

This window is READ ONLY

Sensor A Temperature—Displays the temperature of the remote CAN Temp Humidity sensor designated as Sensor A.

Sensor A Humidity—Displays the humidity of the remote CAN Temp Humidity sensor designated as Sensor A.

Sensor A Dew Point—Displays the dew point of the remote CAN Temp Humidity sensor designated as Sensor A.

Sensor B Temperature—Displays the temperature of the remote CAN Temp Humidity sensor designated as Sensor B.

Sensor B Humidity—Displays the humidity of the remote CAN Temp Humidity sensor designated as Sensor B.

Sensor B Dew Point—Displays the dew point of the remote CAN Temp Humidity sensor designated as Sensor B.

Supply Refrigerant Temperature—Displays the actual supply refrigerant temperature from the Liebert® XDP to the modules.

Supply Chilled Water Temperature—Displays the actual the Supply Chilled Water temperature to the Liebert® XDP.

Figure 5.10 Sensor Data Screen, page 2 of 2

SENSOR DATA (page 2 of 2)			◀ UNIT 01 ▶
U313	Daily High Temperature	07:49:57	72°F
U314	Daily Low Temperature	07:11:30	64°F
U315	Daily High Humidity	11:31:46	45%
U316	Daily Low Humidity	07:56:18	34%
U317	Daily High Dew Point	07:47:26	45°F
U318	Daily Low Dew Point	08:02:20	37°F
U319	Daily High Refrigerant Temp	13:01:25	69°F
U320	Daily Low Refrigerant Temp	13:01:11	69°F
U321	Daily High CW Temp	14:01:33	55°F
U322	Daily Low CW Temp	14:01:45	55°F
U323			
U324			

This window is READ ONLY

Daily High Temperature—Shows the highest temperature in a rolling 24 hour period for either remote Sensor A or remote Sensor B.

Daily Low Temperature—Shows the lowest temperature in a rolling 24 hour period for either remote Sensor A or remote Sensor B.

Daily High Humidity—Shows the highest humidity in a rolling 24 hour period for either remote Sensor A or remote Sensor B.

Daily Low Humidity—Shows the lowest humidity in a rolling 24 period for either remote Sensor A or remote Sensor B.

Daily High Dew Point—Shows the highest dew point in a rolling 24 hour period for either remote Sensor A or remote Sensor B.

Daily Low Dew Point—Shows the lowest dew point in a 24 hour period for either remote Sensor A or remote Sensor B.

Daily High Refrigerant Temperature—Shows the highest supply refrigerant temperature in a rolling 24 hour period from the Liebert® XDP to the modules.

Daily Low Refrigerant Temperature—Shows the lowest supply refrigerant temperature in a rolling 24 hour period from the Liebert® XDP to the modules

Daily High Chilled Water Temperature—Shows the highest chilled water supply temperature being delivered to the Liebert® XDP in a rolling 24 hour period.

Daily Low Chilled Water Temperature—Shows the lowest chilled water return temperature being delivered to the Liebert® XDP in a rolling 24 hour period.

Figure 5.11 Display Setup Screen

DISPLAY SETUP		SYSTEM
U401	Language	ENGLISH (US)
U402	Date	8/27/2012
U403	Time	15:03:17
U404	Temperature Indication	°F
U405	Display Contrast	30
U406	Buzzer Frequency	Off/ 50
U407	Backlite Off after	5 min
U408	Screen	Unit View
U409		
U410	Display Colors	Normal
U411	Date Format	mm/dd/yyyy

⬅➡ for next/previous unit ⬅➡ to select parameter
 ⬅➡ then ⬅➡ to change parameter ⬅➡ to confirm

Language—Sets the language on the display. Changing this setting changes all menu parameters to the selected language.

Date—Sets the internal date of the unit. If this unit is connected to other units with the unit-to-unit network connection, each unit will reflect the last date set.

Time—Sets the internal time of the unit. If this unit is connected to other units with the unit-to-unit network connection each unit will reflect the last time set.

Temperature Indication—Selects the actual and setpoint temperature scale. Selecting C will set the unit to display in Celsius and F will set the unit to display in Fahrenheit.

Display Contrast—Changes the contrast of the display to adjust for different viewing angles, low light and bright light conditions. As the display ages, the contrast may require adjustment for viewing.

Buzzer Frequency—Changes the audible noise frequency of the built-in buzzer. The buzzer will sound when its frequency is being adjusted, easing selection of a frequency easily detected when an alarm occurs.

Backlite Off After—Controls how long the back-light remains active when the display is unused. When the buttons on the front display have not been pressed for the time selected in this parameter, the back-light will turn Off, extending the life of the display and saving energy.

Screen—Controls the screen layout. The Liebert® XDP has one view, Unit View.

Display Colors—Selects the background color. Inverted sets the display to show white font with blue background and Normal sets a white background with blue font.

Date Format—Date format changes the month, day and year arrangement shown on the front display and on event time stamps.

Figure 5.12 Module Status Screen, page 1 of 20

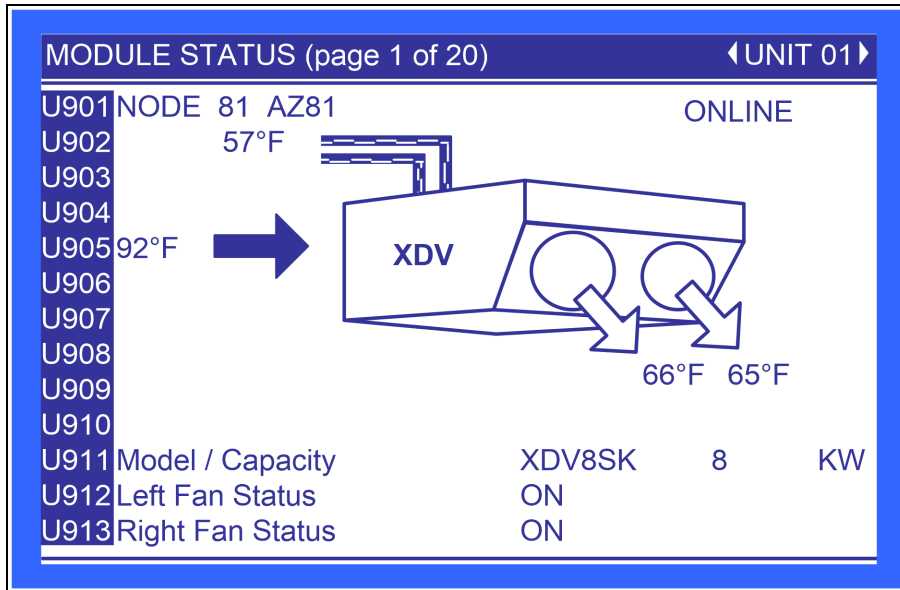

Module Node ID—The location within the CANbus. Each module’s ID is factory-set to 80 and is automatically changed during setup; requires no user action.

Module Labels—A four-character label consisting of two letters and two numerals. This is the standard nomenclature for Data Center Grid assignment of racks. Additionally, the module’s location can be denoted with 10 characters, either letters or non-alphanumeric characters from a built-in list. Either or both labels can be used and are entered using the Module Setup found in the Service menu (S910).

Module Status—Indicates whether the smart module is connected to the CANbus.

Figure 5.13 Vertiv™ Liebert® XDV Smart Module Status Screen

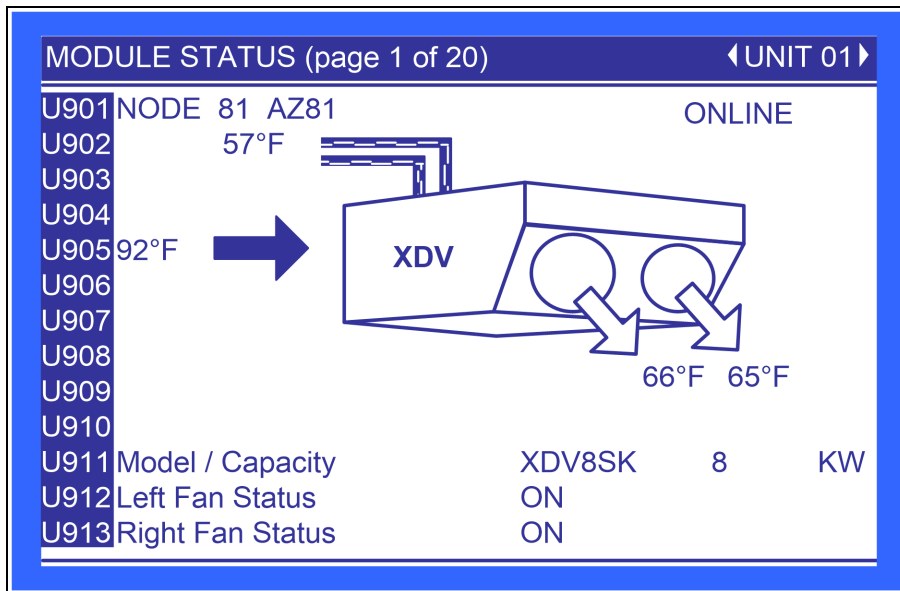

U905—Displays the temperature of the air entering the Liebert® XDV.

U908—Displays the temperature of the air leaving the right and left fan of the Liebert® XDV.

U911—Displays the module type and calculated local module capacity; possible module types are XDV8SK, XDV8SS, XDV8ST, XDV10SK, XDV10SS and XDV10ST.

U912—Displays the left fan status; possible values are ON and OFF.

U913—Displays the right fan status; possible values are ON, OFF and ON ECON. ON ECON indicates that only one fan is On.

Figure 5.14 Vertiv™ Liebert® XDH Smart Module Status Screen—Each Bank Shown Separately

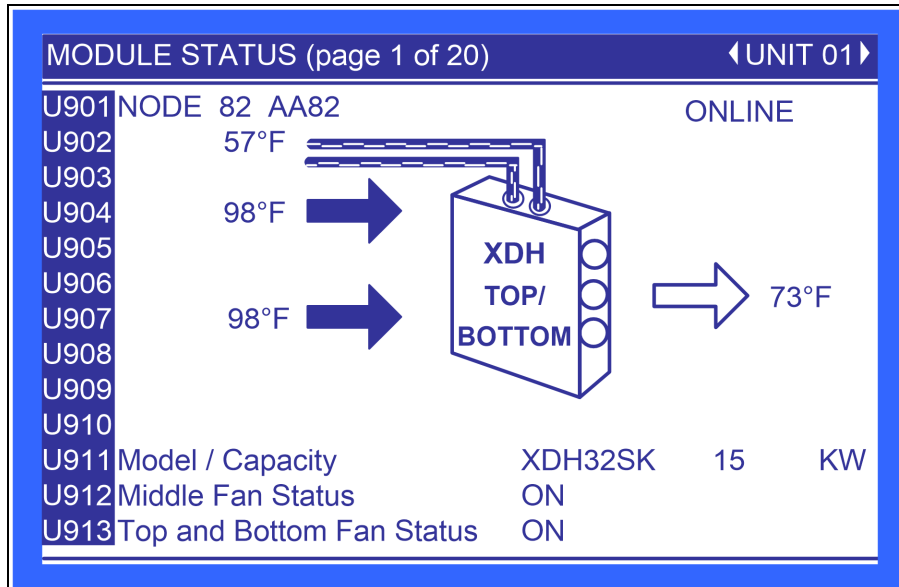

U904—Displays the temperature of the air entering the top of the bank of the Liebert® XDH.

U905—Displays the temperature of the air leaving the Liebert® XDH.

U907—Displays the temperature of the air entering the bottom of the bank of the Liebert® XDH.

U911—Displays the module type and calculated local module capacity; possible module types are XDH20SK, XDH20SS, XDH32SK and XDH32SS.

U912—Displays the middle fan status; possible values are ON and OFF.

U913—Displays the top and bottom fans' status; possible values are ON, OFF and ON ECON. (ON ECON indicates that two fans have been turned On.)

Figure 5.15 Vertiv™ Liebert® XDO Smart Module Status Screen

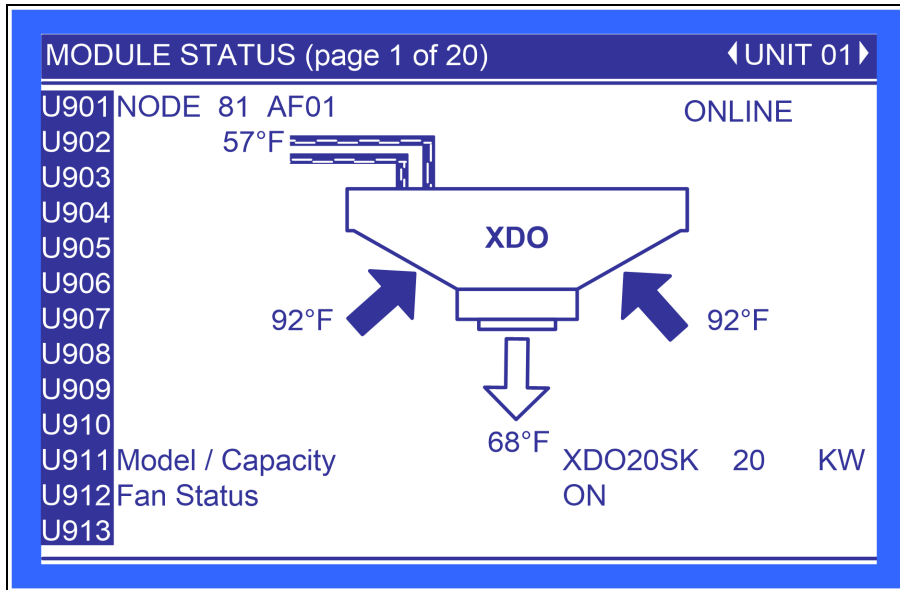

U907—Displays the temperature of the air entering from the right and left of the Liebert® XDO.

U910—Displays the temperature of the air leaving the Liebert® XDO.

U911—Displays the module type and calculated local module capacity; possible module types XDO16SK, XDO16SS and XDO20SS.

U912—Displays the fan status; possible values are ON and OFF.

Figure 5.16 Total Run Hours Screen

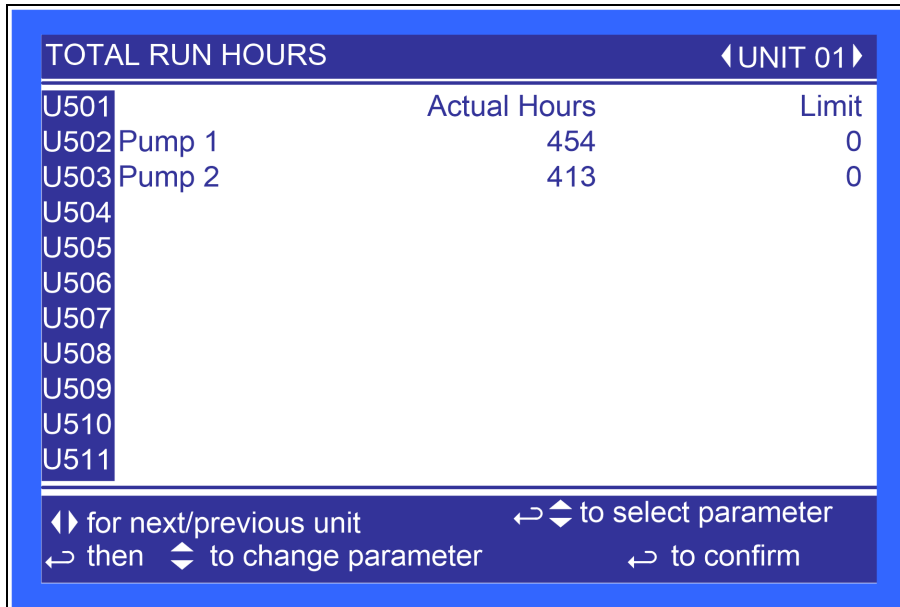

The parameter shows the actual hours Pump 1 and Pump 2 have operated and the maximum time Pump 1 can operate before the next maintenance.

5.9 Liebert® iCOM™ Service Menu Icons and Legend

Table 5.3 Liebert® iCOM™ Service Menu Icons Descriptions

Icon	Description	Icon	Description
	Setpoints - View and change operational setpoints		Sensor Calibration/Setup - Set up and calibrate sensors for site
	Unit Diary - Shows all program changes and maintenance performed,		Network - Set up or alter network setting
	Maintenance/Wellness Settings - Shows all maintenance records, calculates next maintenance date		Options Setup - Enter specific settings for various options
	Diagnostics/Service Mode - Enter Diagnostics/Service Mode for troubleshooting and repair		Smart Module - Setup of alarms and events. Set temperature limits for supply and return sensors. Label smart modules, view firmware version
	Set Alarms - Change settings for alarms		Service Contacts - Contains key contact information for service

NOTE: Menu shows icons only; text is explanatory and does not appear on the Liebert® iCOM™ display.

Figure 5.17 Liebert® XDP Service Menu Screen

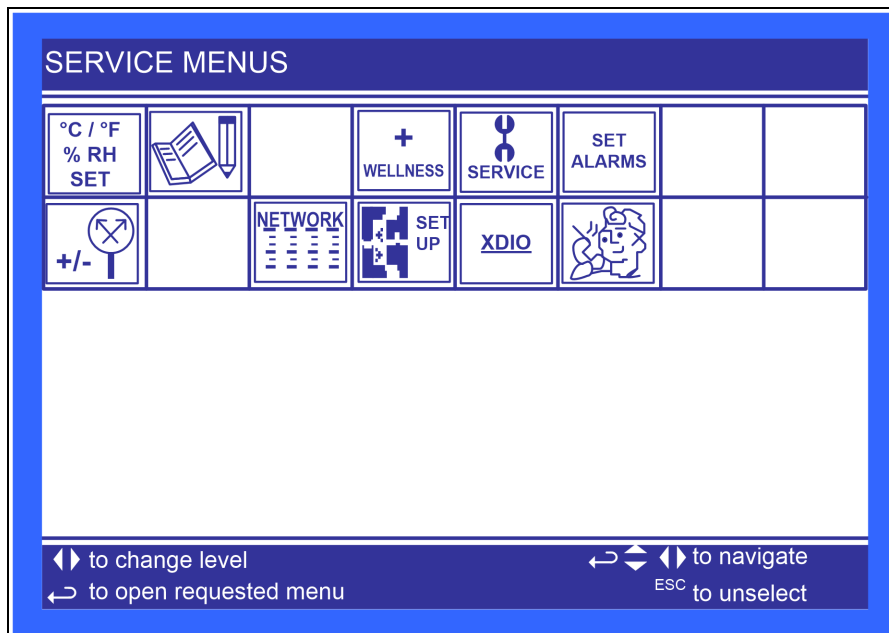

5.10 Vertiv™ Liebert® iCOM™ Service Menu Screens

Service menus allow customized settings for site operations. Service Menu screens employ a coding that begins with S and is followed by parameters and information, such as settings. Gaining access to most Service Menus requires entering a password; the Service Menu password is **5010**; see [Entering the Password](#) on page 39 for assistance.

The Liebert® iCOM™ control firmware is being updated constantly. As a result, the Service Menu parameters in this manual may be slightly different from what is shown on a cooling unit's display. Check www.Vertiv.com for the latest Liebert® iCOM™ User Manual updates.

Figure 5.18 Setpoints Screen

SETPOINTS		◀ UNIT 01 ▶
S101	PASSWORD (Actual Level 0)	????
S102	Min Room Temperature Setpoint	60.0°F
S103	Temperature Control Type	Intelligent
S104	Temperature Proportional Band	7.0°F
S105	Temperature Integration Time	min
S106	Temperature Derivative	sec
S107	Dewpoint Margin	4.0°F
S108	Minimum Control Point	50.0°F
S109	Min Percent Cooling Setpoint	10%
S110		
S111		

◀▶ for next/previous unit ↵ to select parameter
 ↵ then ◀▶ to change parameter ↵ to confirm

Min Room Temperature Setpoint—Sets the minimum room temperature the unit will attempt to maintain. If the temperature falls below this point, the unit will raise the refrigerant temperature to reduce the amount of cooling. Adjustable from 50 to 80°F (10.0 to 26.7°C), the factory default setting is 60°F (15.6°C).

NOTE: This is not a true room temperature setpoint. The Vertiv™ Liebert® XDP has no heaters; it will try to cool as much as possible. If the Liebert® XDP is able to cool the room to this setpoint, it will reduce its cooling action to try to keep the room temperature at or above this setpoint.

For optimal cooling performance, the minimum temperature setpoint should be 1-2° below the expected temperature at the remote sensors, which may affect placement of the remote sensors. If the minimum temperature setpoint is set above the typical remote temperature sensor reading, it will reduce the Vertiv™ Liebert® XD cooling output and, in extreme cases, cause erratic Liebert® XD performance.

Temperature Control Type—Selects the type of control the system will use to activate cooling. The Liebert® iCOM™ control has three temperature control types: Proportional, PI and Intelligent. The factory default is Intelligent.

Proportional—If Proportional Control is selected, the percent cooling requirement is determined by the difference between the air temperature sensor reading and the temperature setpoint. As the air temperature rises above the temperature setpoint, the percent cooling required increases proportionally (from 0 to 100%) over half the programmable temperature proportional band. The percent heating requirement (0 to 100%) is determined the same way when the air temperature falls below the setpoint.

PI—If PI Control is selected, the percent cooling requirement is calculated by adding together two individual terms, proportional and integral. The proportional term is calculated in a manner similar to the previously described Proportional control. The integral term (sometimes called reset action) is calculated by measuring how much and for how long the air temperature has been above or below the setpoint. If the actual air temperature is above the setpoint, the percent requirement is slowly but continuously increased until the total is sufficient to bring the return room air back to the setpoint.

Intelligent—If Intelligent Control is selected, the air temperature is controlled at or near the setpoint. The percent temperature adjustment required is calculated based on logic that is programmed into the control. These rules simulate the actions that would be taken by a human operator manually controlling the system.

Temperature Proportional Band—Adjusts the activation points of compressors or rate of change based on the actual sensor values deviation from setpoint. The smaller this number the faster the compressors and valve(s) will increase capacity. Too small of a number may cause the unit to short cycle the compressors or excessively reposition the valve. This parameter is adjustable from 1.8 to 54.0°F (1.0 to 30.0°C). The factory default setting is 7.0°F (3.9°C).

Temperature Integration Time—Temperature integration takes into consideration the amount of time the actual temperature has deviated from the setpoint. The larger this deviation is the longer the unit will wait before corrective action is taken to achieve the setpoint. This parameter is adjustable from 0 to 15 minutes. The factory default is 0.

Temperature Derivative Time—Monitors the rate of change and will reduce or increase the amount of corrective action based on the actual temperature increasing or decreasing toward the temperature setpoint. This parameter is adjustable from 0-900 seconds. The factory default is 0.

Dewpoint Margin—Selects the difference between the room dew point and the refrigerant temperature control point. This parameter is adjustable from 4.0 to 10.0°F (2.2 to 6.0°C). The factory default setting is 4.0°F (2.2°C).

Minimum Control Point—Sets the minimum supply refrigerant temperature the Liebert® XDP will maintain. This parameter is adjustable from 40 to 80°F (4.4 to 27.0°C). The factory default is 55°F (12.8°C).

Min Percent Cooling Setpoint—Selects the lowest percent call for cooling during normal operations. Whenever the unit is not in start-up mode or OFF, the percent call for cooling cannot go below this value. The parameter is adjustable from 5 to 30%. The factory default is 15%.

Figure 5.19 Maintenance—Basic Settings Screen, page 1 of 7

Basic Settings (page 1 of 7)		SYSTEM
S001	PASSWORD (Actual Level 0)	????
S002	Maintenance Frequency Per Year	1
S003	Max Bonus	0
S004	Max Penalty	0
S005	Last Maintenance	08/25/2011
S006	Service Engineer	NOBODY
S007	Confirm PM	No
S008	Calculated Next Maintenance	08/2014
S009		
S010		
S011		

⬅️➡️ for next/previous unit ⬅️⬆️➡️ to select parameter
 ⬅️ then ⬆️ to change parameter ⬅️ to confirm

Maintenance Frequency Per Year—Sets the number of expected maintenance visits in a one year time span.

Max Bonus—Increases the time until the next required maintenance. Service personnel should assign a bonus when a service visit finds all components working optimally.

Max Penalty—Decreases the time until the next maintenance cycle. Service personnel should assign a penalty when a service visit finds excessive wear on components.

Last Maintenance—Date set during the service call. It also indicates to other service personnel the date of the last visit.

Service Engineer—Provides a label for the service representative to list either the company name or representative's name.

Confirm PM—Confirms that the service representative has completed the preventive maintenance and resets the next maintenance date.

Calculated Next Maintenance—Provides a date to for the next expected maintenance based on the last preventive maintenance performed (Confirm PM), component starts, run hours and the penalty or bonus set in the Liebert® iCOM™ control.

Figure 5.20 Maintenance—Pump 1 Settings Screen, page 2 of 7

Pump 1 Settings (page 2 of 7)		◀ UNIT 1 ▶
S012	PASSWORD (Actual Level 0)	????
S013	Number of Starts	31
S014	Run Hours	453hrs
S015	Average Run Time	876min
S016	Starts per Day Best	1
S017	Starts per Day Worst	24
S018	Number of Alarms	1
S019	Actual Bonus	0
S020		
S021		
S022		

◀▶ for next/previous unit ↵↻ to select parameter
 ↵ then ↻ to change parameter ↵ to confirm

Number of Starts—Shows the number of starts for the unit's Pump 1.

Run Hours—Shows the number of run hours for the unit's Pump 1.

Average Run Time—Shows the average run time of the unit's Pump 1.

Starts per Day Best—Displays the lowest number of starts in a rolling 24 hour period for Pump 1.

Starts per Day Worst—Displays the highest number of starts in a rolling 24 hour period for Pump 1.

Number of Alarms—Displays the number of alarms that have occurred with the unit's Pump 1.

Actual Bonus—Displays the actual calculation of wellness for the unit's Pump 1. The unit will always take the value from the worst component for the next maintenance indication.

Figure 5.21 Maintenance—Pump 2 Settings Screen, page 3 of 7

Pump 2 Settings (page 3 of 7)		◀ UNIT 1 ▶
S023	PASSWORD (Actual Level 0)	????
S024	Number of Starts	2
S025	Run Hours	0hrs
S026	Average Run Time	0min
S027	Starts per Day Best	1
S028	Starts per Day Worst	24
S029	Number of Alarms	1
S030	Actual Bonus	0
S031		
S032		
S033		

◀▶ for next/previous unit ↵↔ to select parameter
 ↵ then ↕ to change parameter ↵ to confirm

Number of Starts—Shows the number of starts for the unit's Pump 2.

Run Hours—Shows the number of run hours for the unit's Pump 2.

Average Run Time—Shows the average run time of the unit's Pump 2.

Starts per Day Best—Displays the lowest number of starts in a rolling 24 hour period for Pump 2.

Starts per Day Worst—Displays the highest number of starts in a rolling 24 hour period for Pump 2.

Number of Alarms—Displays the number of alarms that have occurred with the unit's Pump 2

Actual Bonus—Displays the actual calculation of wellness for the unit's Pump 2. The unit will always take the value from the worst component for the next maintenance indication.

Figure 5.22 Maintenance Screens, pages 4 through 7

<p>Compressor 1A Settings (page 4 of 7) ◀ UNIT 1 ▶</p> <p>S034 PASSWORD (Actual Level 0) ???? S035 S036 S037 S038 S039 S040 S041 S042 S043 S044</p> <p>◀▶ for next/previous unit ↵↔ to select parameter ↵ then ↕ to change parameter ↵ to confirm</p>	<p>Compressor 1B Settings (page 5 of 7) ◀ UNIT 1 ▶</p> <p>S045 PASSWORD (Actual Level 0) ???? S046 S047 S048 S049 S050 S051 S052 S053 S054 S055</p> <p>◀▶ for next/previous unit ↵↔ to select parameter ↵ then ↕ to change parameter ↵ to confirm</p>
<p>Compressor 2A Settings (page 6 of 7) ◀ UNIT 1 ▶</p> <p>S056 PASSWORD (Actual Level 0) ???? S057 S058 S059 S060 S061 S062 S063 S064 S065 S066</p> <p>◀▶ for next/previous unit ↵↔ to select parameter ↵ then ↕ to change parameter ↵ to confirm</p>	<p>Compressor 2B Settings (page 7 of 7) ◀ UNIT 1 ▶</p> <p>S067 PASSWORD (Actual Level 0) ???? S068 S069 S070 S071 S072 S073 S074 S075 S076 S077</p> <p>◀▶ for next/previous unit ↵↔ to select parameter ↵ then ↕ to change parameter ↵ to confirm</p>

Pages 4 through 7 apply only to the Liebert® XDC. No Liebert® XDP parameters are present.

Figure 5.23 Diagnostics/Service Mode Screen, page 1 of 6

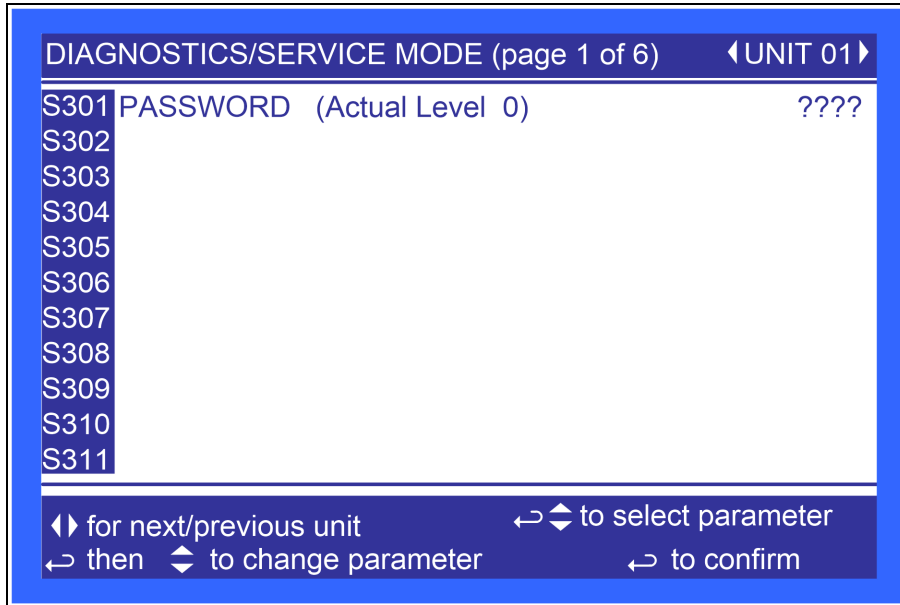

Page 1 applies to the Liebert® XDC only. No Liebert® XDP parameters are present.

Figure 5.24 Diagnostics/Service Mode Screen, page 2 of 6

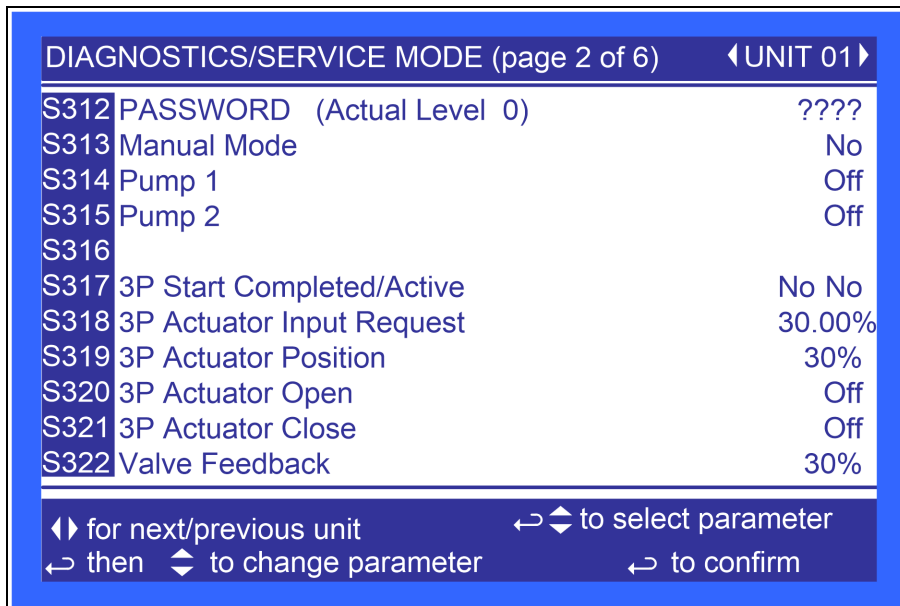

Manual Mode—Used to place the Liebert® iCOM™ control in manual mode. This is the initial setting necessary to activate any of the following items. When the Liebert® iCOM™ is not in manual mode, each service menu item shows the current status of each parameter.

Pump 1—Starts the unit’s Pump 1.

Pump 2—Starts the unit’s Pump 2.

3P Start Active/Complete—Displays if the start-up routine is active, and if it is completed.

3P Actuator Input Request—Shows the % call for cooling.

3P Actuator Position—Sets the position of the actuator 0-100% in manual mode.

3P Actuator Open—Opens the 3P actuator when set to ON in manual mode.

3P Actuator Close—Closes the 3P actuator when set to ON in manual mode

Valve Feedback—Opens the valve % in manual mode.

Figure 5.25 Diagnostics/Service Mode Screen, page 3 of 6

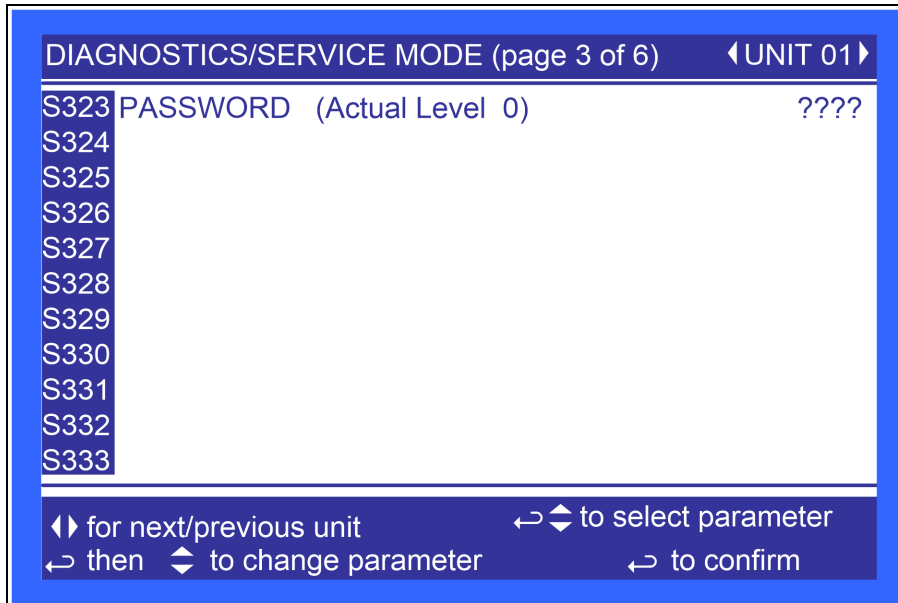

Page 3 applies to the Liebert® XDC only. No Liebert® XDP parameters are present.

Figure 5.26 Diagnostics/Service Mode Screen, page 4 of 6

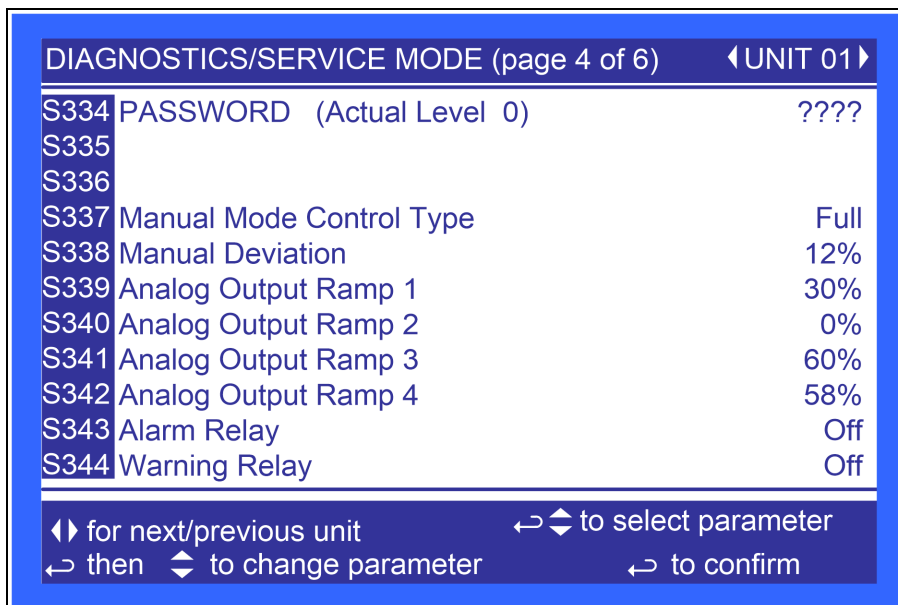

Manual Mode Control Type—Not currently used.

Manual Deviation—Not currently used.

Analog Output Ramp 1—Sets the value of Analog Output 1 value as a percentage. The factory default for the Liebert® XDP is the Valve % Open.

Analog Output Ramp 2—Sets the value of Analog Output 2 value as a percentage. The factory default for the Liebert® XDP is the Call for Cooling.

Analog Output Ramp 3—Sets the value of Analog Output 3 value as a percentage. The factory default for the Liebert® XDP is the CW Temp.

Analog Output Ramp 4—Sets the value of Analog Output 4 value as a percentage. The factory default for the Liebert® XDP is the refrigerant temperature.

Alarm Relay—Used to activate the Liebert® iCOM™ common alarm relay output.

Warning Relay—Used to activate the Liebert® iCOM™ warning relay output.

Figure 5.27 Diagnostics/Service Mode Screen, page 5 of 6

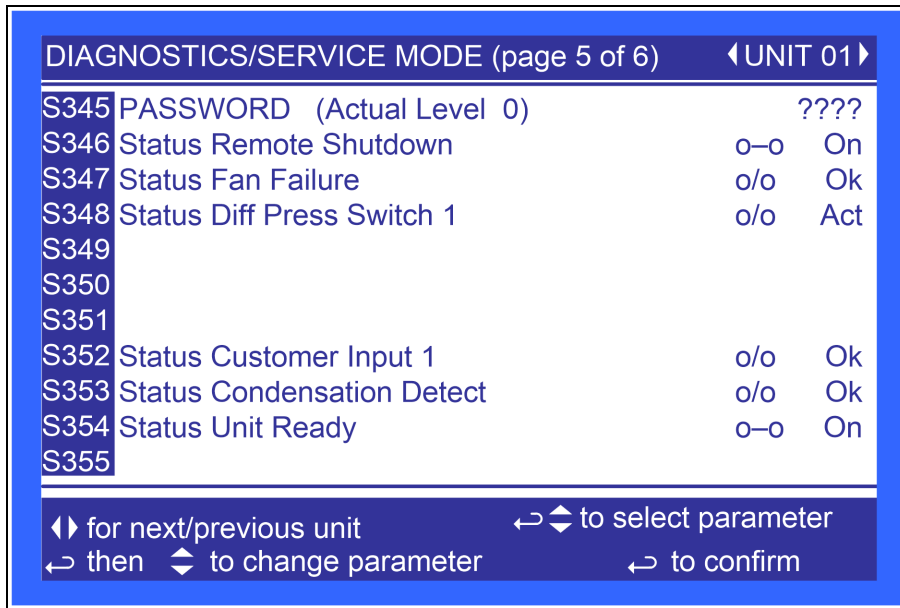

Status Remote Shutdown—Displays the status of the unit’s remote shutdown input.

Status Fan Failure—Displays the status of the dry contact to communicate fan failure at a module. (The dry contacts are not used to communicate a fan failure alarm when using CANbus.)

Status Diff Press Switch 1—Displays the status of the differential pressure switch.

Status Customer Input 1—Displays the status of the customer input 1 alarm.

Status Condensation Detect—Displays the status of the dry contact to communicate condensate detection at a module.

Status Unit Ready—Shows unit status when a secondary device, such as a fire detection system, is employed.

Figure 5.28 Diagnostics/Service Mode Screen, page 6 of 6

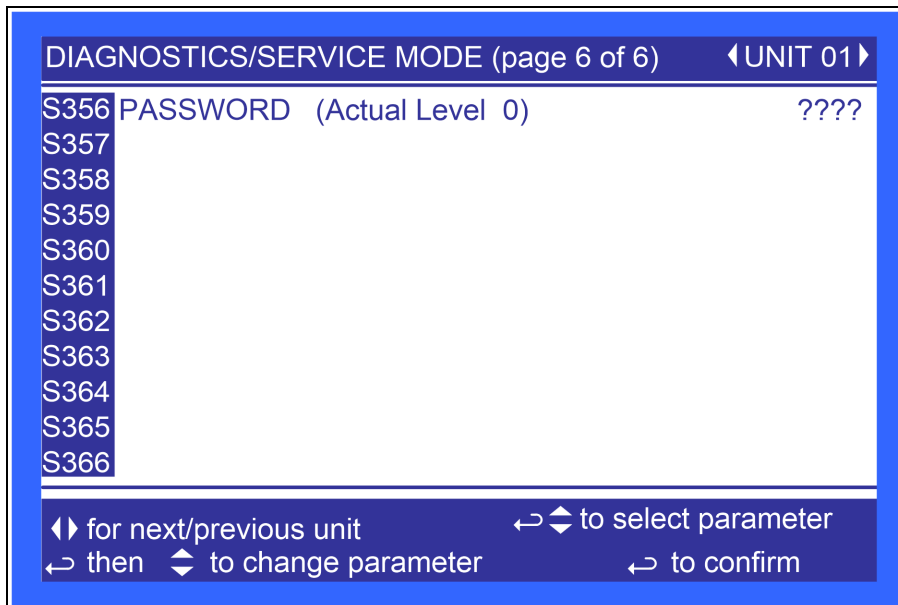

Page 6 applies to the Liebert® XDC only. No Liebert® XDP parameters are present.

Figure 5.29 Set Alarms Screen, page 1 of 7

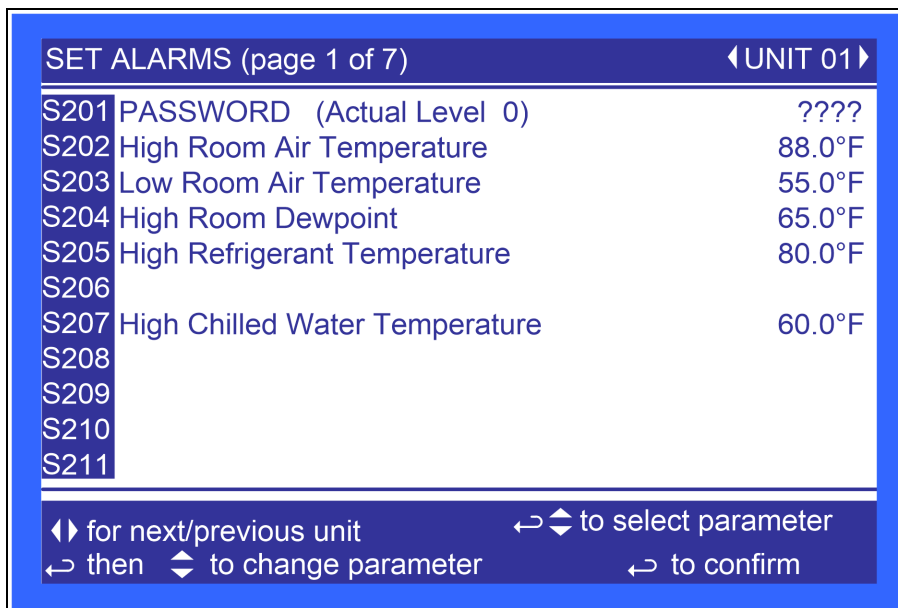

High Room Air Temperature—Sets the threshold for a high room air temperature alarm. The range for the high room air temperature alarm is from 33.8 to 95°F (1 to 35°C); the default is 80°F (26.7°C).

Low Room Air Temperature—Sets the threshold for a low room air temperature alarm. The range for the low room air temperature alarm is from 33.8 to 95°F (1 to 35°C); the default is 55°F (12.8°C).

High Room Dewpoint—Sets the threshold for a return high dew point alarm. The range for the high room dew point alarm is from 33.8 to 95°F (1 to 35°C); the default is 65°F (18.3°C).

High Refrigerant Temperature—Sets the threshold for a high refrigerant temperature alarm. The range for the high supply refrigerant temperature alarm is from 33.8 to 95°F (1 to 35°C); the default is 80°F (26.7°C).

High Chilled Water Temperature—Sets the threshold chilled water temperature for a supply high chilled water temperature alarm. The range for the high supply refrigerant temperature alarm is from 33.8 to 95°F (1 to 35°C); the default is 60°F (15.6°C).

Figure 5.30 Set Alarms Screen, page 2 of 7

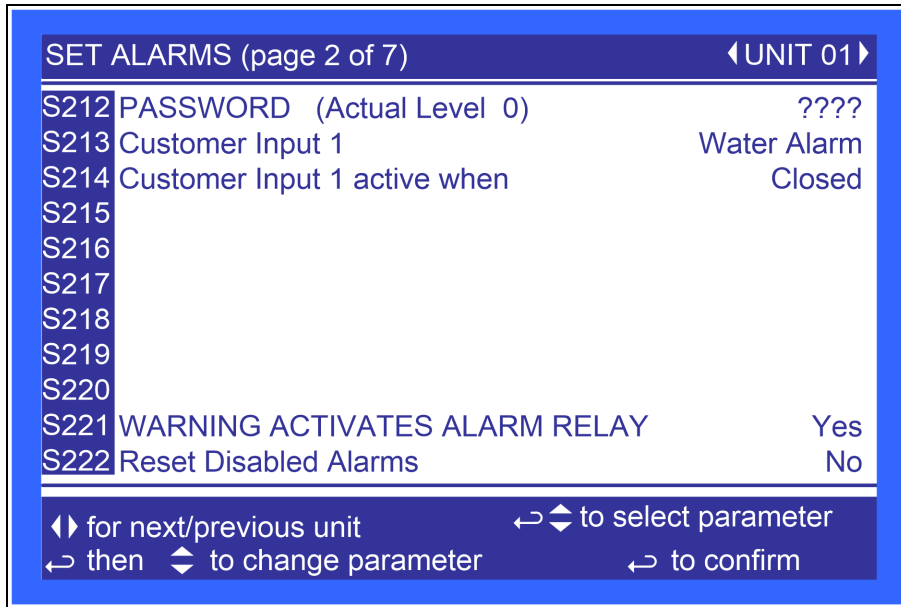

Customer Input 1—Selects the device and operation of the customer input. Each event reflects a different alarm and possible action to the unit. Selectable options are:

- Call Service
- C-Input
- Water
- Smoke

Customer Input 1 active when—Selects whether the Customer Input 1 input is normally closed or normally open.

WARNING ACTIVATES ALARM RELAY—Sets the alarm relay (K3) to activate when a warning occurs.

Reset Disabled Alarms—Resets disabled events.

The **Figure 5.31** on the facing page through **Figure 5.35** on page 64 permit setting the operation of an active alarm. Each event can be enabled or disabled and can be set to operate as an alarm, warning or message. The delay is the time the control waits before reporting the event.

Alarm: Annunciates the buzzer, triggers a monitoring event, triggers the alarm relay and flashes the red LED on the display.

Warning: Annunciates the buzzer, triggers a monitoring event, shows the event in the event viewer/front display and flashes the red LED on the display.

Message: Shows the event in the event viewer and on the front display

Figure 5.31 Set Alarms Screen, page 3 of 7

SET ALARMS (page 3 of 7)		◀ UNIT 01 ▶		
S223	PASSWORD (Actual Level 0)			????
S224		DELAY	EN-DIS	TYPE
S225	HIGH TEMP SENSOR A	30	ENABLE	ALM
S226	LOW TEMP SENSOR A	30	ENABLE	ALM
S227	HIGH TEMP SENSOR B	30	ENABLE	ALM
S228	LOW TEMP SENSOR B	30	ENABLE	ALM
S229	HIGH DEWPOINT	30	ENABLE	ALM
S230	SENSOR A FAILURE		ENABLE	ALM
S231	SENSOR B FAILURE		ENABLE	ALM
S232	HIGH CHILLED WATER TEMP	30	ENABLE	ALM
S233	SUPPLY CW SENSOR FAILURE		ENABLE	ALM
S234				
S235				

◀▶ for next/previous unit ↵ to select parameter
 ↵ then ⬆ to change parameter ↵ to confirm

HIGH TEMP SENSOR A—Enables or disables the High Temperature Sensor A event, which occurs when the reading from Sensor A is above the user-specified alarm setpoint. Sets how the event is reported: as an alarm, a warning or a message. Specifies how long the control waits before reporting the event.

LOW TEMP SENSOR A—Enables or disables the Low Temperature Sensor A event, which occurs when the reading from Sensor A is below the user-specified alarm setpoint. Sets how the event is reported: as an alarm, a warning or a message. Specifies how long the control waits before reporting the event.

HIGH TEMP SENSOR B—Enables or disables the High Temperature Sensor B event, which occurs when the reading from Sensor B is above the user-specified alarm setpoint. Sets how the event is reported as an alarm, a warning or a message. Specifies how long the control waits before reporting the event.

LOW TEMP SENSOR B—Enables or disables the Low Temperature Sensor B event, which occurs when the reading from Sensor B is below the user-specified alarm setpoint. Sets how the event is reported: as an alarm, a warning or a message. Specifies how long the control waits before reporting the event.

HIGH DEWPOINT—Enables or disables the High Dewpoint event, which occurs when the calculated dew point at Sensor A or Sensor B is above the user-specified alarm setpoint. Sets how the event is reported: as an alarm, a warning or a message. Specifies how long the control waits before reporting the event.

SENSOR A FAILURE—Enables or disables the Sensor A Failure event, which occurs when the control no longer senses a signal from Sensor A. Sets how the event is reported: as an alarm, a warning or a message. Specifies how long the control waits before reporting the event.

SENSOR B FAILURE—Enables or disables the Sensor B Failure event, which occurs when the control no longer senses a signal from Sensor B. Sets how the event is reported: as an alarm, a warning or a message. Specifies how long the control waits before reporting the event.

HIGH CHILLED WATER TEMP—Enables or disables the High Chilled Water Temp event, which occurs when the reading from Supply Chilled Water Sensor is above the user-specified alarm setpoint. Sets how the event is reported: as an alarm, a warning or a message. Specifies how long the control waits before reporting the event.

SUPPLY CW SENSOR FAILURE—Enables or disables the Supply CW Sensor Failure event, which occurs when the control no longer senses a signal from Supply CW Sensor. Sets how the event is reported: as an alarm, a warning or a message. Specifies how long the control waits before reporting the event.

Figure 5.32 Set Alarms Screen, page 4 of 7

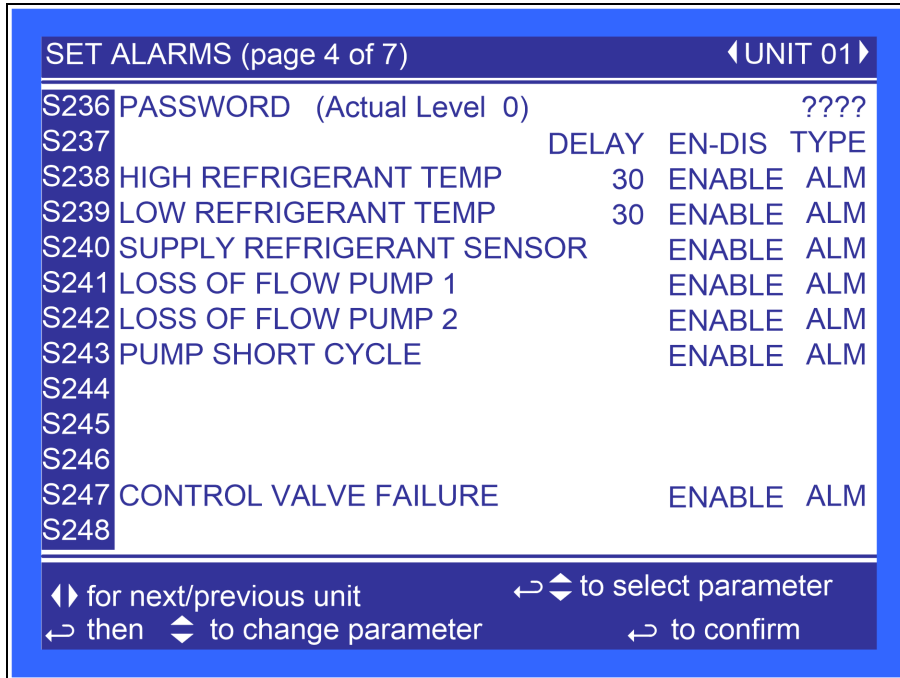

HIGH REFRIGERANT TEMP—Enables or disables the High Refrigerant Temp event, which occurs when the reading from supply refrigerant temperature sensor is above the user-specified alarm setpoint. Sets how the event is reported: as an alarm, a warning or a message. Specifies how long the control waits before reporting the event.

LOW REFRIGERANT TEMP—Enables or disables the Low Refrigerant Temp event, which occurs when the reading from supply refrigerant temperature sensor is below the user-specified alarm setpoint. Sets how the event is reported: as an alarm, a warning or a message. Specifies how long the control waits before reporting the event.

SUPPLY REFRIGERANT SENSOR—Enables or disables the Supply Refrigerant Sensor event, which occurs when the control no longer senses a signal from the Supply Refrigerant Sensor. Sets how the event is reported: as an alarm, a warning or a message. Specifies how long the control waits before reporting the event.

LOSS OF FLOW PUMP 1—Enables or disables the Loss of Flow Pump 1 event, which occurs when Pump 1 is commanded to run and the differential pressure switch does not sense differential pressure. Sets how the event is reported: as an alarm, a warning or a message. Specifies how long the control waits before reporting the event.

LOSS OF FLOW PUMP 2—Enables or disables the Loss of Flow Pump 2 event, which occurs when Pump 2 is commanded to run and the differential pressure switch does not sense differential pressure. Sets how the event is reported: as an alarm, a warning or a message. Specifies how long the control waits before reporting the event.

PUMP SHORT CYCLE—Enables or disables the Pump Short Cycle event, which occurs when flow is not established by either pump for 30 minutes. Sets how the event is reported: as an alarm, a warning or a message. Specifies how long the control waits before reporting the event.

CONTROL VALVE FAILURE—Enables or disables the Control Valve Failure event, which occurs when the chilled water control valve has been commanded by the control to open or close and no change is detected by the valve position signal. Sets how the event is reported: as an alarm, a warning or a message. Specifies how long the control waits before reporting the event.

Figure 5.33 Set Alarms Screens, pages 5 and 6

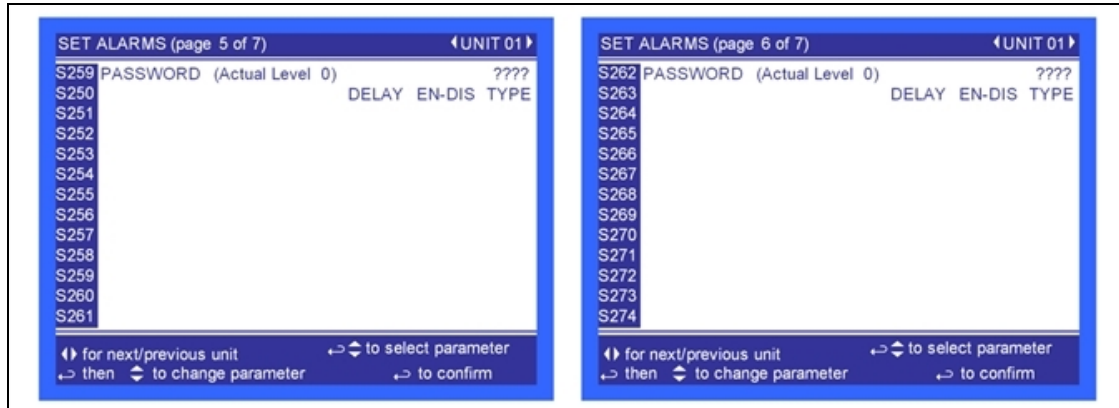

Pages 5 and 6 apply to the Liebert® XDC only. No Liebert® XDP parameters are present.

Figure 5.34 Set Alarms Screen, page 7 of 7

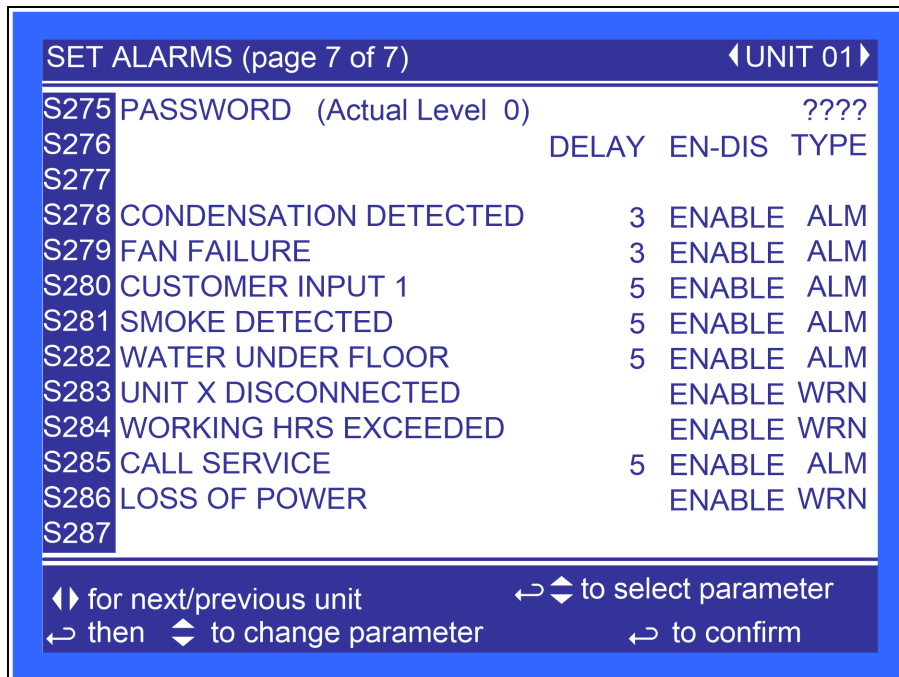

CONDENSATION DETECTED—Enables or disables the Condensation Detected event, which occurs when water is detected at a Liebert® XD cooling module. Sets how the event is reported: as an alarm, a warning or a message. Specifies how long the control waits before reporting the event.

FAN FAILURE—Enables or disables the Fan Failure event, which occurs when a fan failure occurs at a Liebert® XD cooling module. Sets how the event is reported: as an alarm, a warning or a message. Specifies how long the control waits before reporting the event.

CUSTOMER INPUT 1—Enables or disables the Customer Input 1 event, which occurs when 24VAC is applied to the input. Sets how the event is reported: as an alarm, a warning or a message. Specifies how long the control waits before reporting the event.

SMOKE DETECTED—Enables or disables the Smoke Detected event, which occurs when the Customer Input 1 is configured for “Smoke Detected” and 24VAC is applied to the input. Sets how the event is reported: as an alarm, a warning or a message. Specifies how long the control waits before reporting the event.

NOTE: This is not a room smoke detector and is not intended to replace external smoke detectors.

WATER UNDER FLOOR—Enables or disables the Water Under Floor event, which occurs when the Customer Input 1 is configured for “Water Under Floor” and 24VAC is applied to the input. Sets how the event is reported: as an alarm, a warning or a message. Specifies how long the control waits before reporting the event.

UNIT X DISCONNECTED—Not currently used.

WORKING HOURS EXCEEDED—Enables or disables the Working Hrs Exceeded event, which occurs when a component has exceeded the user-specified limit. Sets how the event is reported: as an alarm, a warning or a message. Specifies how long the control waits before reporting the event.

CALL SERVICE—Enables or disables the Call Service event, which occurs when the Customer Input 1 is configured for “Call Service” and 24VAC is applied to the input. Sets how the event is reported: as an alarm, a warning or a message. Specifies how long the control waits before reporting the event.

LOSS OF POWER—Enables or disables the Loss of Power event, which occurs when the unit is On and operational and the 24VAC power to the control is lost. Sets how the event is reported: as an alarm, a warning or a message. Specifies how long the control waits before reporting the event.

Figure 5.35 Sensor Calibration/Setup Screen, page 1 of 3

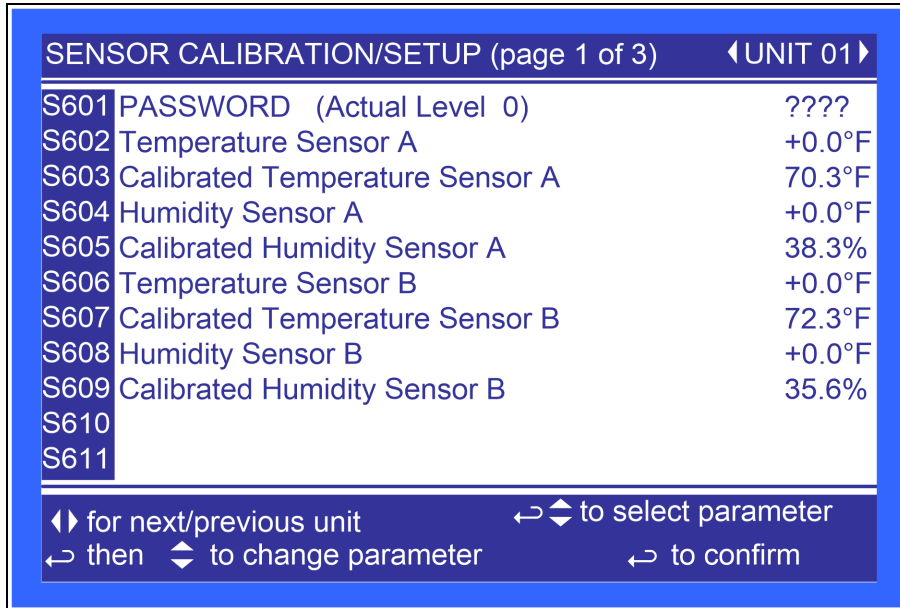

Temperature Sensor A—Adjusts the temperature reading from the actual remote CAN Temp Humidity sensor designated as Sensor A to compensate for any error of the sensor or to match other sensors in the room.

Calibrated Temperature Sensor A—Displays the adjusted temperature value of the remote CAN Temp Humidity sensor designated as Sensor A. This value is the actual sensor reading plus or minus the offset Temperature Sensor A.

Humidity Sensor A—Adjusts the humidity reading from the actual remote CAN Temp Humidity sensor designated as Sensor A to compensate for any error of the sensor or to match other sensors in the room.

Calibrated Humidity Sensor A—Displays the adjusted humidity value of the remote CAN Temp Humidity sensor designated as Sensor A. This value is the actual sensor reading plus or minus the offset Humidity Sensor A.

Temperature Sensor B—Adjusts the temperature reading from the actual remote CAN Temp Humidity sensor designated as Sensor B to compensate for any error of the sensor or to match other sensors in the room.

Calibrated Temperature Sensor B—Displays the adjusted temperature value of the remote CAN Temp Humidity sensor designated as Sensor B. This value is the actual sensor reading plus or minus the offset Temperature Sensor B.

Humidity Sensor B—Adjusts the humidity reading from the actual remote sensor designated as Sensor B to compensate for any error of the sensor or to match other sensors in the room.

Calibrated Humidity Sensor B—Displays the adjusted humidity value of the remote CAN Temp Humidity sensor designated as Sensor B. This value is the actual sensor reading plus or minus the offset Humidity Sensor B.

Figure 5.36 Sensor Calibration/Setup Screen, page 2 of 3

SENSOR CALIBRATION/SETUP (page 2 of 3)		◀ UNIT 01 ▶
S612	PASSWORD (Actual Level 0)	????
S613	Supply Refrigerant Sensor	+0.0°F
S614	Calibrated Supply Refrigerant Sensor	58.5°F
S615		
S616		
S617	Supply Chilled Water Sensor	+0.0°F
S618	Calibrated Supply Chilled Water Sensor	60.1°F
S619		
S620		
S621		
S622		

◀▶ for next/previous unit ↵↕ to select parameter
 ↵ then ↕ to change parameter ↵ to confirm

Supply Refrigerant Sensor—Adjusts the temperature reading from the actual supply refrigerant sensor to compensate for any error of the sensor.

Calibrated Supply Refrigerant Sensor—Displays the adjusted temperature value of the supply refrigerant sensor. This value is the actual sensor reading plus or minus the offset Supply Refrigerant Sensor.

Supply Chilled Water Sensor—Adjusts the temperature reading from the actual supply chilled water sensor to compensate for any error of the sensor.

Calibrated Chilled Water Sensor—Displays the adjusted temperature value of the supply chilled water sensor. This value is the actual sensor reading plus or minus the offset Supply Chilled Water Sensor.

Figure 5.37 Sensor Calibration/Setup Screen, page 3 of 3

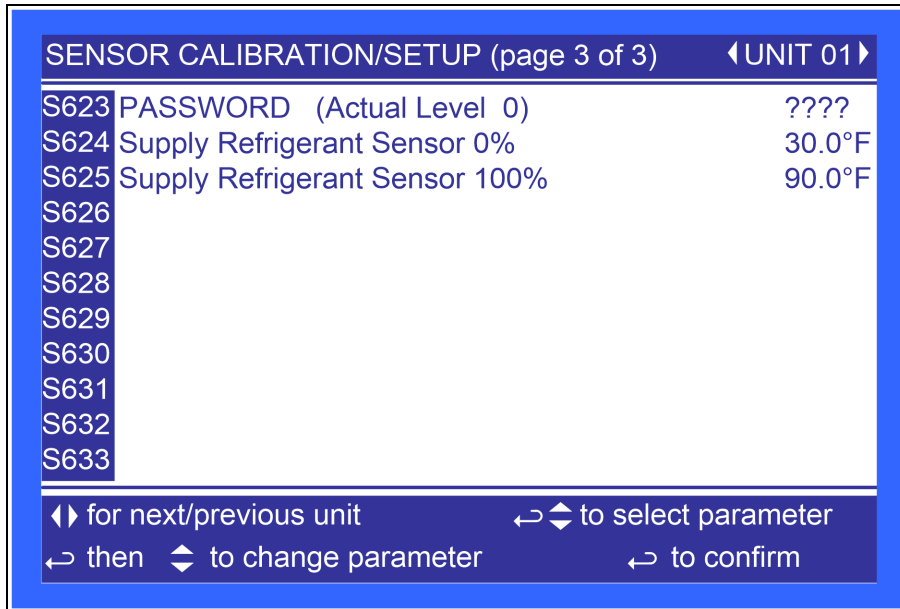

Supply Refrigerant Sensor 0%—Allows the sensor reading to be calibrated at the lowest reading of the sensor. This calibration changes the start point of the sensor reading.

Supply Refrigerant Sensor 100%—Allows the sensor reading to be calibrated at the highest reading of the sensor. This calibration changes the end point of the sensor reading.

Figure 5.38 System/Network Setup Screen—System, page 1 of 2

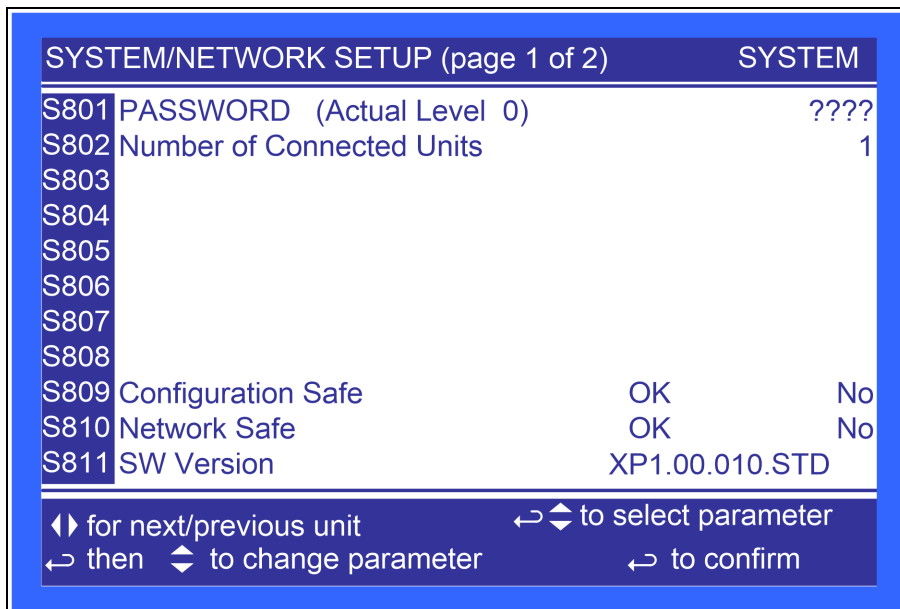

NOTE: Liebert® XDP does not support Teamwork Mode or Standby - Lead/Lag operation.

Number of Connected Units—Shows the number of displays connected. This is always 1.

Configuration Safe—Saves or loads configuration settings for the display that have been modified from the factory defaults to an internal file that can be downloaded/uploaded using the Liebert® iCOM™ Service Tool. Selecting **Save** will write the settings to the internal storage file and selecting **Load** will write the settings from the internal storage file to the application software. The internal file is updated automatically every 12 hours.

Network Safe—Saves or loads network settings for the display that have been modified from the factory defaults to an internal file that can be downloaded/uploaded using the Liebert® iCOM™ Service Tool. Selecting **Save** will write the settings to the internal storage file and selecting **Load** will write the settings from the internal storage file to the application software.

SW Version—Contains the application software version loaded onto the Liebert® iCOM™ display.

Figure 5.39 System/Network Setup Screen—System, page 2 of 2

SYSTEM/NETWORK SETUP (page 2 of 2)		SYSTEM
S812	PASSWORD (Actual Level 0)	????
S813	IP Address	192.168.254.003
S814	Netmask	255.255.255.000
S815	Gateway	0.000.000.000
S816	MAC	00:00:68:19:40:C7
S817	U2U Protocol	GBP
S818	U2U Address	33
S819	U2U Group	1
S820		
S821	Bootloader Variables	OK No
S822		

Attention: any changes done on these parameters must be followed by a 'Save+Reboot' command.

IP Address—Contains the network address of the display. This address must be unique on the network. The factory default is 192.168.254.003.

Netmask—Defines which part of the IP address is used for the network. The factory default is 255.255.255.000.

Gateway—A network point that acts as an entrance to another network. The factory default is 0.000.000.000.

MAC—A unique hardware identifier for the Ethernet device. The following parameters (U2U Protocol, U2U Address and U2U Group) are for displaying other networked Liebert® XDPs. The Liebert® XDP does not perform Teamwork Operations.

U2U Protocol—This is always set to GBP.

U2U Address—A unique identifier for each display on the network. Display addresses range from 33 to 64. Each display on the U2U network must have a different U2U address. Not currently used.

U2U Group—Used to create zones or groups within a U2U network. Once a group number is selected, the display will see only other devices with the same group number. The group number can be changed to view other devices in different groups. Not currently used.

Bootloader Variables—Indicates the bootloader has changed since it was last loaded. This parameter should only be activated by an authorized service person.

Figure 5.40 System/Network Setup Screen—Unit, page 1 of 2

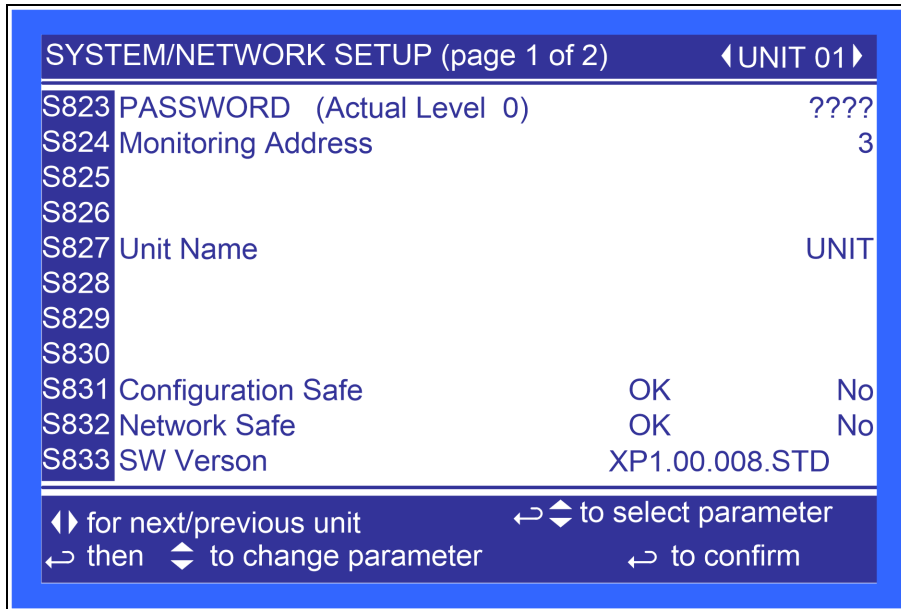

Monitoring Address—Sets the address used by the Liebert® IntelliSlot cards. This is set to 3 at the factory and should not be changed.

Unit Name—Identifies the unit from the local or remote display. This label will show at the top right of every screen that has monitoring or configuration of that unit

Configuration Safe—Saves or loads configuration settings for the control board that have been modified from the factory defaults to an internal file that can be downloaded / uploaded using the Liebert® iCOM™ Service Tool. Selecting **Save** will write the settings to the internal storage file and selecting **Load** will write the settings from the internal storage file to the application software. The internal file is updated every 12 hours automatically.

Network Safe—Saves or loads network settings for the control board that have been modified from the factory defaults to an internal file that can be downloaded/uploaded using the Liebert® iCOM™ Service Tool. Selecting **Save** will write the settings to the internal storage file and selecting **Load** will write the settings from the internal storage file to the application software.

SW Version—Contains the application software version loaded onto the Liebert® iCOM™.

Figure 5.41 System/Network Setup Screen—Unit, page 2 of 2

SYSTEM/NETWORK SETUP (page 2 of 2)		◀ UNIT 01 ▶	
S834	PASSWORD (Actual Level 0)		????
S835	Monitoring Protocol		Velocity V4
S836	IP Address		192.168.254.003
S837	Netmask		255.255.255.000
S838	Gateway		0.000.000.000
S839	MAC		00:00:68:19:9B:42
S840	U2U Protocol		GBP
S841	U2U Address		1
S842	U2U Group		1
S843	Bootloader Variables	OK	No
S844	Static RAM	OK	No

Attention: any changes done on these parameters must be followed by a 'Save+Reboot' command.

Monitoring Protocol—Selects the monitoring protocol. Velocity V4 is the factory default which will provide communications to the Liebert® IntelliSlot housing. IGMnet will activate the 77/78 terminals for communication to the Liebert® SiteLink(-E). Liebert® Hironet™ is only used on Liebert® HPM units.

IP Address—Contains the network address of the display. This address must be unique to every other device on the network. The factory default is 192.168.254.003.

Netmask—Defines which part of the IP address is used for the network. The factory default is 255.255.255.000.

Gateway—A gateway is a network point that acts as an entrance to another network. The factory default is 0.000.000.000.

MAC—The MAC address is a unique hardware identifier of the Ethernet device.

The following parameters (U2U Protocol, U2U Address and U2U Group) are for displaying other Liebert® XDPs that are networked. The Liebert® XDP does not perform Teamwork Operations.

U2U Protocol—Always set to GBP.

U2U Address—Unique identifier for each display on the network. Display addresses range from 1 to 32. Each display on the U2U network must have a different U2U address. Not currently used.

U2U Group—Creates zones or groups within a U2U network. Once a group number is selected the display will only see other devices with the same group number. The group number can be changed to view other devices in different groups. Not currently used.

Bootloader Variables—Indicates if there has been a change to the boot loader since it was last loaded. This parameter should only be activated by authorized service personnel.

Static RAM—Allows service personnel to clear and reboot the RAM of the control board. Only Vertiv service personnel should perform this function.

Figure 5.42 Options Setup Screen, page 1 of 2

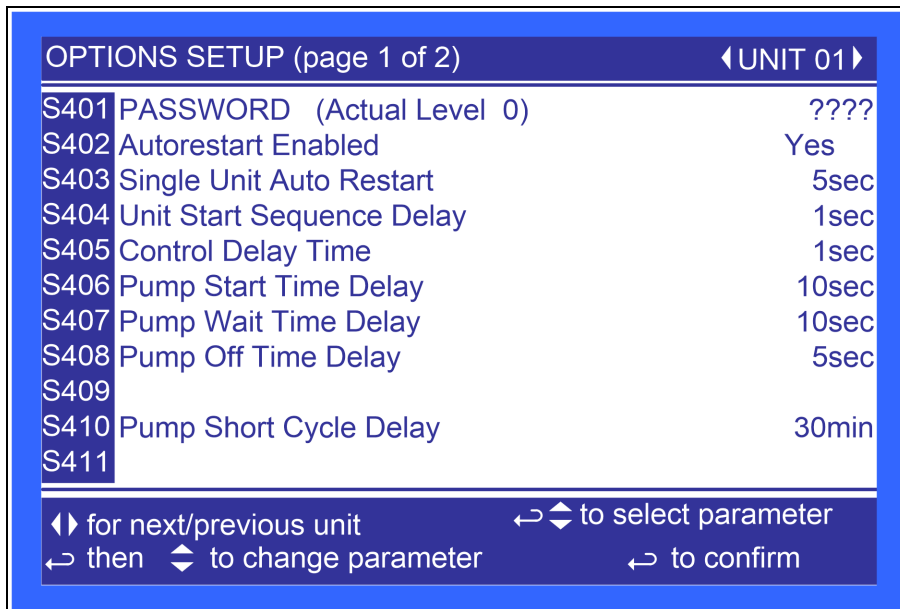

Autorestart Enabled—Restarts the unit after a power cycle when set to Yes. When this parameter is set to No, the unit will not restart after a power cycle.

Single Unit Auto Restart—Sets a time delay for the unit to restart when the Auto Restart Enabled is set to Yes. The delay begins once the boot process has completed. This parameter allows units to be staggered On to reduce the amount of simultaneous power consumption after a loss of power.

Unit Start Sequence Delay—Not currently used.

Control Delay Time—Not currently used.

Pump Start Time Delay—Sets a time delay to ensure that refrigerant begins flowing when the pump starts. If refrigerant does not begin flowing before the user-set delay expires, the pump will be turned Off.

Pump Wait Time Delay—Sets the pump wait time delay to prevent the pump from continuing to run when refrigerant is not flowing. If a pump is running normally and refrigerant flow is lost, the pump will stay On for the specified time trying to re-establish refrigerant flow. If refrigerant flow resumes during the specified interval, the pump will continue operating. If the wait time expires and refrigerant flow has not resumed, the pump will shut down.

Pump Off Time Delay—Sets the length of time a pump will remain off when refrigerant flow is interrupted or stops. After the time delay has expired, the control will try to restart the pump.

Lead Pump—Sets which pump is the active pump. It can be set to PUMP 1 or PUMP 2. The control will operate the respective pump unless a loss of flow condition occurs. On a LOSS OF FLOW condition, the control will switch to the standby pump after the LOSS OF FLOW alarm time delay has elapsed and the LOSS OF FLOW alarm has been annunciated. The default is PUMP 1.

Pump Short Cycle Delay—Sets the time to lock Off the unit if it is unable to establish refrigerant flow within this set amount of time.

Figure 5.43 Options Setup Screen, page 2 of 2

OPTIONS SETUP (page 2 of 2)		◀UNIT 01▶
S412	PASSWORD (Actual Level 0)	????
S413	Valve Start Open	30%
S414	Valve Start TD	90sec
S415	3P Actuator Runtime	70sec
S416	3P Actuator Direction	Direct
S417	Unit Off Valve % Open	30%
S418		
S419		
S420		
S421		
S422		

◀▶ for next/previous unit ↵↕ to select parameter
 ↵ then ↕ to change parameter ↵ to confirm

Valve Start Open—Sets position of the valve when the unit starts.

Valve Start TD—Sets a time interval for the unit to complete start-up and enter into normal operation.

3P Actuator Runtime—If Valve Control is selected for **Time** then this parameter sets the travel time of the valve to determine the full open and closed position of the valve. This parameter is set at the factory, based on the valve manufacturer's specifications.

3P Actuator Direction—Sets if the valve is a **Direct** or **Reverse** acting valve.

Unit Off Valve % Open—Sets the valve position when the unit is OFF.

Figure 5.44 Module Setup Screen, page 1 of 20

MODULE SETUP (page 1 of 20)		◀UNIT 01▶
S901	PASSWORD (Actual Level 0)	????
S902	NODE ID 81	DELAY EN-DIS TYPE
S903	CONDENSATION DETECTED	15 ENABLE
S904	LOCAL MODULE SHUTDOWN	15 ENABLE ALM
S905	SENSOR FAILURE	30 ENABLE ALM
S906	FAN FAILURE	30 ENABLE ALM
S907	FAN CONTROL MODE	OFF
S908	DISABLE LOCAL BUTTON	NO
S909	FLASH LED AT MODULE	NO
S910	SET MODULE LABEL	A Z 81
S911	SUPPLY AIR TEMP LIMITS	High 80 Low 50 °F
S912	RETURN AIR TEMP LIMITS	High 120 Low 60 °F
S913	FIRMWARE VERSION	XXX.XX.XXX

This screen selects the operation of an active alarm for each smart module. Each event can be enabled or disabled and can be set to operate as an alarm, a warning or a message. The delay is the time the control waits before reporting the event.

Alarm: Annunciates the buzzer, triggers a monitoring event, triggers the alarm relay and flashes the red LED on the display.

Warning: Annunciates the buzzer, triggers a monitoring event, shows the event in the event viewer/front display and flashes the red LED on the display.

Message: Shows the event in the event viewer and on the front display.

Fan Control Type—Sets the fan control mode. Values can be OFF, ON, ON ALL and TEMP CNTL.

Disable Local Button—Disables the push button on the front of the smart module. To disable the push button, set the parameter to YES. To re-enable the push button, set the parameter to NO.

Flash LED at Module—Flashes the LED on the smart module when set to Yes.

Set Module Label—A four-character label consisting of two letters and two numerals. This is the standard nomenclature for Data Center Grid assignment of racks. Additionally, the module’s location can be denoted with 10 characters, either letters or non-alphanumeric characters from a built-in list. Either or both labels can be used and are entered using this screen.

Supply Air Temp Limit—Sets the high and low supply air temperature to from the module. An alarm will occur if the temperature falls outside the limits.

Return Air Temp Limit—Sets the high and low return air temperature to from the module. An alarm will occur if the temperature falls outside the limits.

Firmware Version—Displays the firmware version installed on the smart module.

Figure 5.45 Module Setup Screen, page 1 of 20

MODULE SETUP (page 1 of 20)		◀ UNIT 01 ▶		
S901	PASSWORD (Actual Level 0)		????	
S902	NODE ID 81	DELAY	EN-DIS	TYPE
S903	CONDENSATION DETECTED	15	ENABLE	
S904	LOCAL MODULE SHUTDOWN	15	ENABLE	ALM
S905	SENSOR FAILURE	30	ENABLE	ALM
S906	FAN FAILURE	30	ENABLE	ALM
S907	FAN CONTROL MODE		OFF	
S908	DISABLE LOCAL BUTTON		NO	
S909	FLASH LED AT MODULE		NO	
S910	SET MODULE LABEL		A Z 81	
S911	SUPPLY AIR TEMP LIMITS	High 80	Low 50	°F
S912	RETURN AIR TEMP LIMITS	High 120	Low 60	°F
S913	FIRMWARE VERSION		XXX.XX.XXX	

6 Start the Vertiv™ Liebert® XDP with Liebert® iCOM™

6.1 Checklist for Liebert® XDP Start-up



CAUTION: Risk of piping and component rupture. May cause equipment damage or injury. Closing service valves may isolate liquid refrigerant, causing high pressure and rupture of piping. Do not close valves without following recommended procedures for repair, maintenance and replacement of components. Install pressure relief valves in field piping that may become isolated by service valves.

NOTICE

Risk of unintended pump start. Can cause equipment damage.

Do not install the pump fuses for 60Hz units until the system is fully charged with refrigerant. Do not remove the locking mechanisms from 50Hz circuit breakers or place in the On position until the system is fully charged with refrigerant. Operating the pumps without a full refrigerant charge can result in equipment damage.

NOTE: The Vertiv™ Liebert® XDP160 requires a minimum load of 48kW (163,800BTU/H) before the system can be commissioned. This load can be supplied by actual user load in racks, by independent load banks or by the “Load Bank Testing” service of Vertiv Services. To achieve the minimum load requirements, the capacity of all connected modules must total at least 48kW (163,800BTU/H). See [Minimum Load](#) on page 5 .

NOTE: Before any action that could cause a disturbance in the Vertiv™ Liebert® XD system’s cooling function is begun, the facility manager **MUST** be informed. In addition, after the action is taken and the work is finished, the facility manager **MUST** be informed.

1. Verify that bypass flow controllers were installed (if applicable), see [Bypass Flow Controller](#) on page 29 .
2. Verify that the minimum load level of 48kW (163,800BTU/H) is present.
3. Check all isolation ball valves in the Liebert® XDP and Liebert® XD cooling module and verify that all are open.
4. Check rotation of the Liebert® XDP’s pumps. Rotation should be counterclockwise and in the same direction as the arrow. See [Vertiv™ Liebert® XDP Pump Rotation Determination](#) on the next page for arrow location on the pump.

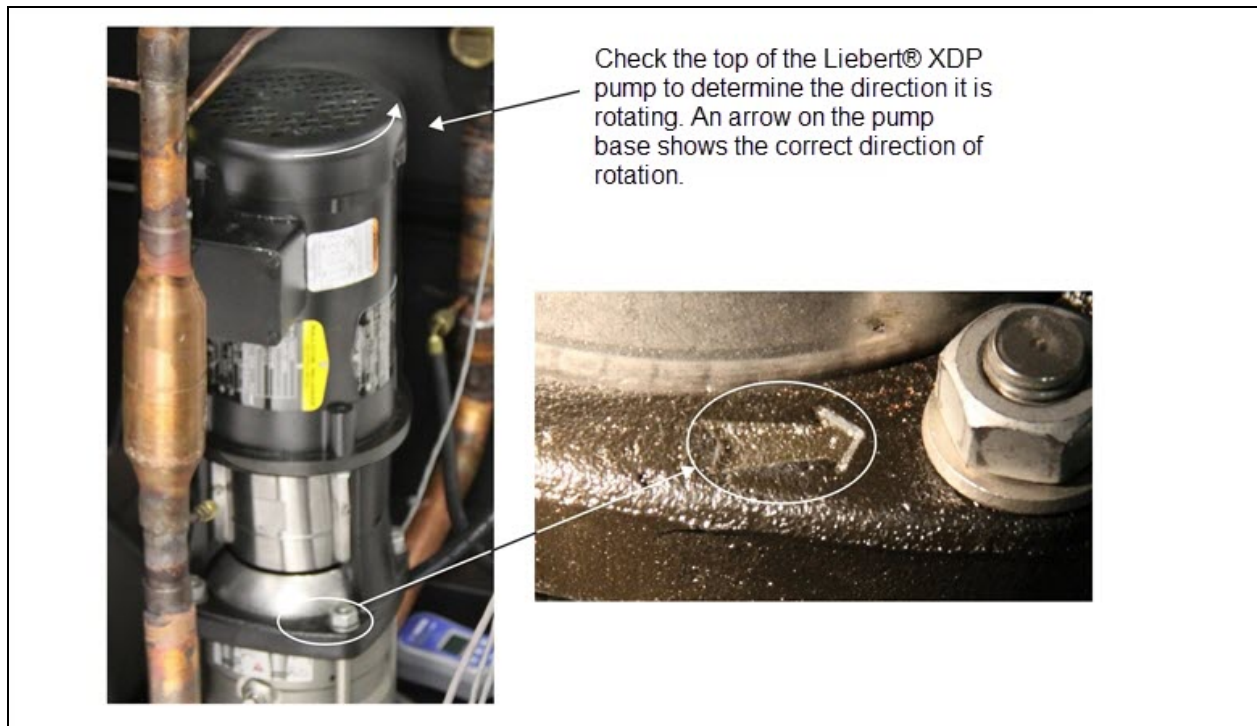
Figure 6.1 Vertiv™ Liebert® XDP Pump Rotation Determination

5. Check rotation of fans on Liebert® XD cooling module units.
6. Verify that air is being discharged into the cold aisle.
7. Confirm that the total calculated refrigerant R-134a amount has been properly charged into the system. (See [Filling the Pumped Circuit—R-134a](#) on page 32)
8. Confirm that the remote temperature/humidity sensors provided have been installed in optimal locations. (See [Remote Sensor Installation—Proper Placement](#) on page 26)

The Liebert® XDP system is now ready to be turned ON.

6.2 Starting the Vertiv™ Liebert® XDP with Liebert® iCOM™ Controller

The Liebert® XDP is started, stopped and controlled through the Liebert® iCOM™ controller. **Figure 5.1** on page 35 shows the Liebert® iCOM™ keypad.

1. Turn the Liebert® XDP On with the user interface (I/O button). The factory-setting defaults Liebert® XD module fans to ON. When the Liebert® XDP is turned On, the Liebert® XD modules' fans will turn On. Allow the system to attempt to start for at least 2 minutes.

If the Liebert® XDP pump cannot maintain flow and continues to switch over due to starting difficulties, refer to [Troubleshooting](#) on page 81. After remedying the problem, proceed to step 2.

2. If constant flow is established, wait until the Liebert® XDP has been operating for 10-15 minutes, then verify that the refrigerant level in the receiver sight glass is between the second and third level (see **Figure 6.2** on the facing page). Add or remove charge, if necessary.

NOTICE

Risk of operation with low refrigerant charge. Can cause equipment damage.

Operating the Vertiv™ Liebert® XDP with refrigerant levels below the bottom sight glass can cause permanent pump damage.

3. Check pressure differential functionality:

The Liebert® XDP system should be ON. If it is OFF:

- a. Turn the Liebert® XDP ON via user interface (I/O button). The factory-setting defaults Liebert® XD module fans to ON. When the Liebert® XDP is turned On, the Liebert® XD modules' fans will turn ON.

If no Loss of Flow alarm is present—This suggests that there is flow. Test the pressure differential by closing the ball valve on either the suction line or discharge line to stop the flow.

This should prompt an alarm for “loss of flow on P1.” This alarm confirms that the switch has opened on low pressure (below 6 psi; 41kPa; 0.41 bars).

If a Loss of Flow alarm is present—This suggests that there is no flow. Verify that this is correctly annunciated by looking at the sight glass in the receiver. If a true no-flow condition exists, the level will not move.

However, **if there is flow, but the differential reading is faulty**, the level will slowly drop, indicating flow, while the loss of flow alarm is annunciated.

Check the pressure differential physically by making sure that the electrical connections are properly connected. Then check the pressure differential electrically by making sure that the unit has 24VAC across it.

Figure 6.2 System R-134a Liquid Level at 160kW Load

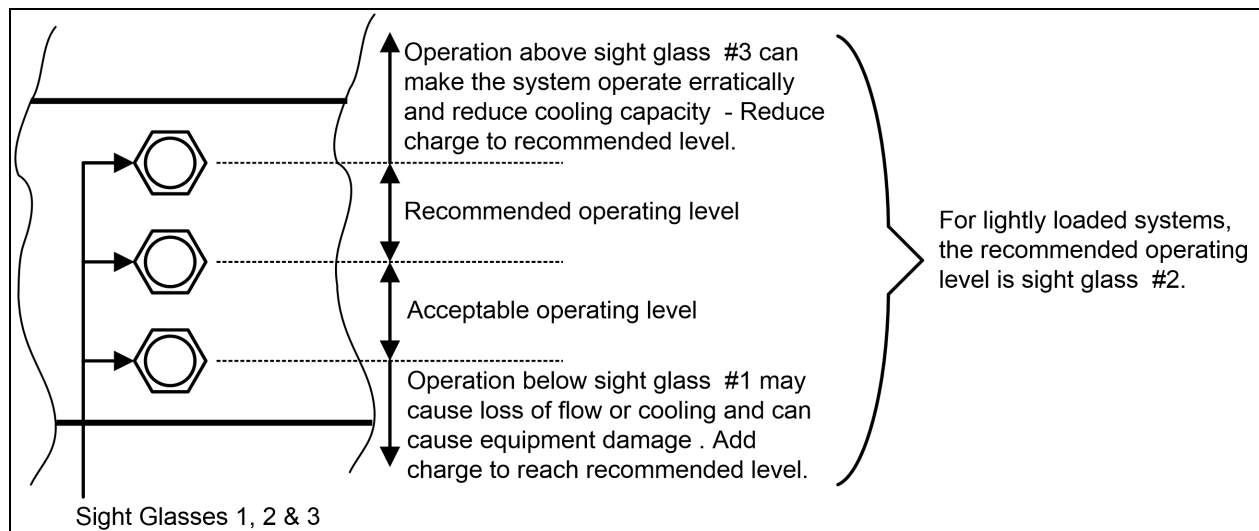

This page intentionally left blank

7 Alarm Descriptions and Solutions

7.1 Alarm Descriptions

NOTE: Alarms must be acknowledged before they can be reset. To acknowledge or silence an alarm, press the ALARM key one time. This will silence the alarm; the red LED will remain illuminated until the alarm is reset.

CALL SERVICE—Activated when Customer Input 1 is configured for **Call Service** and 24VAC is applied to the input. This alarm is reset when the 24VAC is removed.

CONDENSATION DETECTED (optional)—Activated when water is detected at a cooling module. A 24VAC signal is applied to the condensation input on the control board using a pair of twisted wires or the alarm is sent via CANbus communication. When this alarm is active, the control will raise its refrigerant control point by 4°F (2.2°C). This alarm will reset when the alarms is acknowledged and the signal stops being sent from CANbus or condensation input. The alarm can also be reset by cycling the power. The main power must be cycled to remove the 4°F (2.2°C) offset.

CONTROL VALVE FAILURE—Activated when the chilled water control valve has been commanded to open or close by the control and no change is detected by the valve position signal. The alarm is reset when the main power is cycled.

CUSTOMER INPUT 1—Activated when a 24VAC signal is applied to the customer alarm input on the control board. This alarm will reset when the 24VAC signal stops being sent from the customer alarm input. WATER UNDER FLOOR, SMOKE DETECTED, CALL SERVICE, and COMP LOCK PD are possible designations for this alarm; they are set with the Unit Code.

FAN FAILURE (optional)—Activated when a 24VAC signal is applied to the fan failure input on the control board using a twisted pair of wires or the alarm is sent via CANbus communication. This alarm will reset when the alarms is acknowledged and the signal stops being sent from CANbus or fan failure input. The alarm can also be reset by cycling the power.

HIGH CW TEMP—Activated when the Supply CW sensor reads the chilled water temperature above the user-specified alarm setpoint. This alarm will reset when the reading from the refrigerant temperature sensor drops 5°F (2.8°C) below the user-specified setpoint and the alarm has been acknowledged.

HIGH DEW POINT—Activates when the calculated dew point at either Sensor A or B exceeds the user-specified alarm setpoint. The alarm will reset when the calculated room dew point from both Sensor A and Sensor B is 2°F (1.1°C) below the setpoint and the alarm has been acknowledged.

HIGH REFRIGERANT TEMP—Activated when the refrigerant temperature sensor reads the refrigerant temperature above the user-specified alarm setpoint. This alarm will reset when the reading from the refrigerant temperature sensor drops 2°F (1.1°C) below the user-specified setpoint and the alarm has been acknowledged.

HIGH TEMP SENSOR A—Activated when the reading from Sensor A is above the user-specified alarm setpoint. The alarm will reset when the reading from Sensor A drops 2°F (1.1°C) below the setpoint and the alarm has been acknowledged.

HIGH TEMP SENSOR B—Activated when the reading from Sensor A is above the user-specified alarm setpoint. The alarm will reset when the reading from Sensor A drops 2°F (1.1°C) below the setpoint and the alarm has been acknowledged.

LOSS OF FLOW PUMP 1—Activated when Pump 1 is commanded to run and the differential pressure switch does not sense differential pressure (set at 6 psi; 41kPa; 0.41 bars). After attempting to start Pump 1 three times, the Liebert® XDP will automatically switch to the other pump to establish flow. This alarm will reset when flow has been established on Pump 1 and the alarm has been acknowledged.

LOSS OF FLOW PUMP 2—Activated when Pump 2 is commanded to run and the differential pressure switch does not sense differential pressure (set at 6 psi; 41kPa; 0.41 bars). After attempting to start Pump 2 three times, the Liebert® XDP will automatically switch to the other pump to establish flow. This alarm will reset when flow has been established on Pump 2 and the alarm has been acknowledged.

LOW MEMORY—Activated when the control board is low in memory resources. This alarm rests automatically as soon as memory consumption falls below the threshold.

LOW REFRIGERANT TEMP—Activated when the supply refrigerant temperature sensor temperature reading drops below the higher of the two calculated dew points, assuming that neither Sensor A or Sensor B has a sensor failure alarm. This alarm will reset when the refrigerant temperature sensor reads the refrigerant temperature above both of the two calculated dew points and the alarm has been acknowledged. This alarm can lock the unit Off. If this occurs, the main power must be cycled, or the Low Refrig Temp Alarm Code in the Service Diagnostics menu must be reset to 0.

LOW TEMP SENSOR A—Activated when the reading from Sensor A drops below the user-specified alarm setpoint. The alarm will reset when the reading from Sensor A rises 2°F (1.1°C) above the setpoint and the alarm has been acknowledged.

LOW TEMP SENSOR B—Activated when the reading from Sensor B drops below the user-specified alarm setpoint. The alarm will reset when the reading from Sensor B rises 2°F (1.1°C) above the setpoint and the alarm has been acknowledged.

NODEX CONDENSATION DETEC—Activated when condensation is detected on a smart module at CAN node ID X, where X is a value ranging from 81 to 100. This alarm resets when condensate is no longer detected. The main power must be cycled off to remove the 4°F (2.2°C) offset value.

NODEX FAN FAILURE—Activated when a fan failure occurs on a smart module at CAN node ID X, where X is a value ranging from 81 to 100. The alarm will reset when the fan returns to normal operation.

NODEX LOCAL SHUT DOWN—Activated when a smart module at CAN node ID X, where X is a value ranging from 81 to 100, has been shut down by an external signal. This alarm will reset when the remote shutdown input is deactivated.

NODEX RETURN AIR TEMPLIMIT—Activated when the return air temperature (entering air temperature to the module) exceeds the user-specified return air temperature range on a smart module at CAN node ID X, where X is a value ranging from 81 to 100. This alarm will reset when the return air temperature returns to within the user-specified range.

NODEX SENSOR FAILURE—Activated when a smart module at CAN node ID X, where X is a value ranging from 81 to 100, stops receiving a signal from one or more of its supply air, return air, or refrigerant temperature sensors. This alarm will reset when signals are detected from the module's sensors.

NODEX SUPPLY AIR TEMPLIMIT—Activated when the supply air temperature (temperature of the air leaving the module) exceeds the user-specified supply air temperature range on a smart module at CAN node ID X, where X is a value ranging from 81 to 100. This alarm will reset when the return air temperature returns to within the user-specified range.

PUMP SHORT CYCLE—Activated when the Liebert® XDP is trying to establish flow (differential pressure) and is unable to do so. The Liebert® XDP will attempt three times to establish flow on a pump before trying the other pump. The control will keep cycling three times on one pump, then three times on the other pump until it is able to establish flow (differential pressure). If this cycling occurs for 30 minutes and the Liebert® XDP still does not establish flow, a PUMP SHORT CYCLE alarm will be present. This alarm will shut down the Liebert® XDP. To reset this alarm, the main power must be cycled.

RAM/BATTERY FAIL—Activated when the RAM backup battery or the RAM itself has failed. This requires a hardware replacement.

SENSOR A FAILURE—Activated when the controls no longer sense a signal from Sensor A. This alarm will reset when the signal is returned and the alarm has been acknowledged.

SENSOR B FAILURE—Activated when the controls no longer sense a signal from Sensor B. This alarm will reset when the signal is returned and the alarm has been acknowledged.

SMOKE DETECTED—Activated when the Customer Input 1 is configured for **Smoke** and 24VAC is applied to the input. This alarm is reset when the 24VAC is removed.

NOTE: This is not a room smoke detector and is not intended to replace external smoke detectors.

SUPPLY CW SENSOR FAILURE—Activated when the control no longer senses a signal from the Supply CW sensor. This alarm will reset when the signal is returned.

SUPPLY REFRIGERANT SENSOR FAILURE—Activated when the control no longer senses a signal from the supply refrigerant sensor. This alarm will reset when the signal is returned.

UNIT CODE MISSING—Activated when a valid unit code has not been entered and saved. To reset, enter valid unit code, save and execute.

WATER UNDER FLOOR—Activated when Customer Input 1 is configured for **Water Alarm** and 24VAC is applied to the input. This alarm is reset when the 24VAC is removed.

7.2 Warning Descriptions

LOSS OF POWER—Activated when the unit is On and operational and 24VAC power to the control is lost. This alarm will be emitted when power is restored to the control. The Liebert® XDP will restart at a user-defined time delay after power is restored. Once activated, the alarm will remain activated for 30 minutes.

PUMP 1 HRS EXCEED—Activated when the Pump 1 Actual Hours exceeds the user-specified limit. To reset, Actual Hours must be reset to 0.

PUMP 2 HRS EXCEED—Activated when the Pump 2 Actual Hours exceeds the user-specified limit. To reset, Actual Hours must be reset to 0.

7.3 System Shutdown Causes

Unit Is Off By Refrig Sens Fail

The control has lost its signal from the refrigerant temperature sensor. The control has no way of controlling the refrigerant temperature, so the unit is shut off. Main power (disconnect switch) must be turned OFF, then back ON to clear this alarm.

Unit Is Off By High CW Temp

The entering chilled water temperature is too high to keep the refrigerant pump(s) running normally. If a HIGH CW TEMP alarm occurs and the refrigerant pump loses flow (differential pressure), then the Vertiv™ Liebert® XDP will go into a pre-chill mode. The Liebert® XDP can attempt to start again only if the entering chilled water temperature drops below the HIGH CW TEMP setpoint.

Unit Is Off By Pump Short Cycle

The control was unable to get a pump started upon start-up or after a loss of differential pressure. The control looks at the SHORT CYCLE time delay. If it cannot establish differential pressure within that amount of time, the unit is shut down. Main power (disconnect switch) must be turned OFF, then back ON to clear this alarm.

Unit Is Off By Low Refrig Temp

The control was unable to raise the refrigerant temperature to the calculated refrigerant temperature control point. The unit is shut down because if the control cannot raise the refrigerant temperature to the calculated refrigerant temperature control point, water may condense on the refrigerant piping and receiving coils. Main power (disconnect switch) must be turned OFF, then back ON to clear this alarm.

This page intentionally left blank

8 Troubleshooting

Table 8.1 Troubleshooting the Liebert® XDP

Symptom	Possible Cause	Check or Remedy
Pump will not energize	No main power	Check L1, L2 and L3 for rated voltage.
	Loose electrical connections	Tighten connections.
	Overloads tripped	Allow pump to cool. Check amp draw. Confirm that the external pump overload trip point settings are correct. See External Pump Overloads on page 20
	Tripped circuit breaker	Check circuit breaker to pump(s).
	Incorrect phase wiring	See Checklist for Liebert® XDP Start-up on page 73 .
Pump will not start or run	No chilled water	Check and verify that there is supply chilled water to the Liebert® XDP.
	Isolation valve(s) on pump suction and/or discharge is closed.	Open all isolation valves completely during normal operation.
	Supply chilled water is too high	Check and verify that the chilled water temperature setpoint is at 50°F (10°C) or lower and that there is flow on the chilled water side.
	Liebert® XD cooling modules are Off	Check Liebert® XD cooling modules to make sure that they are On prior to starting the Liebert® XDP.
	Low Refrigerant Temperature (high dew point)	Check alarm(s) history on Liebert® XDP. The Liebert® XDP was operating below the dew point for a significant amount of time. Check humidity in conditioned space, lower humidity if necessary to allow Liebert® XDP to operate at a lower temperature. (Disconnect must be switched to Off then back ON to allow Liebert® XDP to reset itself).
	Pressure switch not making contact	Check both differential pressure settings. If not within 6 psi, ±1 psi (41kPa, ±7kPa; 0.41 bars, ±0.07bars) then manually change accordingly.
	Not enough charge	See Checklist for Liebert® XDP Start-up on page 73 .
Pump will not start	Chilled water valve not closing completely.	Wait at least 10 minutes before calibrating. Access the Advanced Menu>Factory Settings>Calibrate Actuator. Contact Liebert® Services for assistance, 1-800-543-2778.
Pump noisy	Cavitation due to vapor in pump	Check for adequate charge in system, refer to the User's Manual. Checklist for Liebert® XDP Start-up on page 73
	Worn motor bearings	Replace pump
	Pump is rotating in reverse	See Checklist for Liebert® XDP Start-up on page 73 .
Liebert® XDP (Pump) suddenly stops	Low Refrigerant Temperature	Check humidity of the room along with the location of remote sensors. Make sure that the sensors are not in a cold area where there is insufficient air flow for accurate, representative readings. Chilled Water temperature is too cold. Load is too light.
	Loss of power	When power is restored, the Liebert® XDP will automatically restart.
	Clogged filter dryer and/or impeller	Clean out debris
	Leak in system - loss of charge	Check the entire system for leaks with a refrigerant sniffer. Repair as necessary.
	Low Chilled Water Temperature Alarm and Loss of Flow Pump X Alarm	Check supply chilled water temperature.

Table 8.1 Troubleshooting the Liebert® XDP (continued)

Symptom	Possible Cause	Check or Remedy
	Supply Refrigerant Sensor Failure Alarm	Check wiring. Call service.
Clogged filter dryer and/or impeller	Debris or other contaminants in refrigerant	Replace.
Pipe rattle	Loose pipe connections	Check pipe connections.
Chilled water valve not working	Motor operates but valve won't open	Check linkage for adjustment and be sure that it is tight on the valve.
	No 24 VAC power to motor	Check for 24 VAC between P52-1 and P52-4.
	No signal from control	Check 24 VAC at P22-1 (close) or P22-3 (open).
	Motor not operating	Unplug P22 from the board. Jumper P22-5 to P52-4 for grounding, then jumper P22-1 to P52-1 to drive close. Remove jumper to close and then jumper P22-3 to P52-1 to drive open. If motor fails to work, replace it.
Motor burnout	Check control panel for welded contactor contacts or welded overload contacts	Replace defective components.
Main 24VAC fuse trips	Shorts or loose connections	Check the wiring connections of the 24VAC circuit.
	Faulty circuit board	Replace the circuit board.
Unstable pump operation	R-134a pump loop overcharged	While pump is running R-134a receiver level must be within recommended levels (see Figure 6.2 on page 75).
	R-134a pump loop undercharged	
	Filter Dryer clogged	See Clogged filter dryer and/or impeller above symptom and remedy.
Room becomes too warm	Liebert® XDP is off	Check status of the Liebert® XDP at the user interface. Turn system ON at I/O button if system is OFF.
	High dew point	Check temperature and relative humidity (RH) of room. Lower RH setpoint if necessary to lower dew point. At normal room temperature of 68°F (20°C), the RH should be set to 50% or lower.
	Liebert® XD cooling modules are Off	Check Liebert® XD cooling modules to make sure that they are ON before starting the Liebert® XDP.
	Minimum room temperature setpoint is too high	Check the setpoint in the User Setpoints menu (see Figure 5.18 on page 52).
	Temperature/humidity sensors incorrectly placed	Place the sensor on the return air side of the primary air mover (eg., Liebert® DS). Do not install the sensor near unsealed doors, windows or similar areas.

9 Maintenance

The Vertiv™ Liebert® XD system components require little maintenance when proper fluid levels are maintained and proper start-up and operation procedures are followed. The following tasks should be performed at the intervals stated:

1. Clean or replace chilled water strainer annually. Adjust accordingly based on purity of chilled water.
2. Check sight glass level of receiver every 4-6 weeks. During normal operation, the level should be at or above the second sight glass.
3. Check system for leaks every 4-6 weeks.

This page intentionally left blank

10 Specifications

Table 10.1 Vertiv™ Liebert® XDP160 Specifications

Models	XDP160RC--5	XDP160RA--5	XDP160RM--5
Cooling Capacity, Nominal	160kW / 46 Tons, 60Hz		140kW/40 Tons, 50Hz
	Each capacity is based on 45°F (7°C) entering water temperature and 140gpm (530lpm) water flow rate. Capacity is reduced when glycol mixtures are used in place of 100% water.		
Minimum Load	30% of nominal system capacity or 48kW (163,800BTU/H)		
Electrical Requirements			
Input	208V/3ph/60Hz	460V/3/ph60Hz	380/415V/3ph/50Hz
Full Load Amps	3.9A	2.1A	—
Dimensions, inches (mm)			
Height – Unit only	78 (1981)		
Height – As shipped	83 (2108)		
Width	38 (965)		
Depth	34 (864)		
Weight, lb (kg)			
Unit only	851 (386)		
Shipping weight	Domestic: 1020 (462); Export: 1083 (491)		
Installed, with refrigerant and chilled water	1068 (484)		
Pipe Connections			
Refrigerant supply to Liebert® XD cooling module	1-1/8" OD, Cu		
Refrigerant return from Liebert® XD cooling module	2-1/8" OD, Cu		
Chilled water supply and return	2-5/8" OD, Cu		
Control valve	2-way, 2" nominal; 35 PSIG close-off pressure rating; 150 PSIG maximum allowable pressure		
Pressure Drop – Chilled Water Side	20 psig (137kPa, 1.38bar), with 140 gpm (530lpm) water flow rate, control valve fully open		
Temperature Rise – Chilled Water Side at rated flow, °F (°C)	8.0 (4.4)	6.9 (3.8)	
Number of Liebert® XD cooling units connected, maximum (minimum)			
Liebert® XDH32	5 (2)		
Liebert® XDV8	20 (6)		
Liebert® XDV10	16 (5)		
Liebert® XDO20	8 (3)		

Table 10.1 Vertiv™ Liebert® XDP160 Specifications (continued)

Models	XDP160RC--5	XDP160RA--5	XDP160RM--5
Cabinet Exterior Finish	Black, matte finish, heat-fused powder coat		
Operating Ambient Temperature, Maximum, °F (°C)	86 (30)		
Agency			
Approvals	CSA 60Hz		Consult the factory.

Appendices

Appendix A: Technical Support and Contacts

A.1 Technical Support/Service in the United States

Vertiv Group Corporation

24x7 dispatch of technicians for all products.

1-800-543-2378

Liebert® Thermal Management Products

1-800-543-2378

Liebert® Channel Products

1-800-222-5877

Liebert® AC and DC Power Products

1-800-543-2378

A.2 Locations

United States

Vertiv Headquarters

505 N. Cleveland Ave.

Westerville, OH 43082

Europe

Via Leonardo Da Vinci 8 Zona Industriale Tognana

35028 Piove Di Sacco (PD) Italy

Asia

7/F, Dah Sing Financial Centre

3108 Gloucester Road

Wanchai, Hong Kong

This page intentionally left blank

Connect with Vertiv on Social Media



<https://www.facebook.com/vertiv/>



<https://www.instagram.com/vertiv/>



<https://www.linkedin.com/company/vertiv/>



<https://www.x.com/Vertiv/>



Vertiv.com | Vertiv Headquarters, 505 N. Cleveland Ave., Westerville, OH 43082, USA

© 2024 Vertiv Group Corp. All rights reserved. Vertiv™ and the Vertiv logo are trademarks or registered trademarks of Vertiv Group Corp. All other names and logos referred to are trade names, trademarks or registered trademarks of their respective owners. While every precaution has been taken to ensure accuracy and completeness here, Vertiv Group Corp. assumes no responsibility, and disclaims all liability, for damages resulting from use of this information or for any errors or omissions.

SL-16647_REV6_09-24